

1. Executive Summary

1.1 Introduction

1.1.1 Background

In January 2004, President George W. Bush announced a new Vision for Space Exploration for the National Aeronautics and Space Administration (NASA) that would return humans to the Moon by 2020 in preparation for human exploration of Mars. As part of this vision, NASA would retire the Space Shuttle in 2010 and build and fly a new Crew Exploration Vehicle (CEV) no later than 2014. Initially, since no plans were made for this CEV to service the International Space Station (ISS), international partner assets would be required to ferry U.S. crew and cargo to the ISS after 2010—creating a significant gap in domestic space access for U.S. astronauts. NASA gradually reorganized to better implement the President’s vision and established the Exploration Systems Mission Directorate (ESMD) to lead the development of a new exploration “system-of-systems” to accomplish these tasks. Over the course of the next year, ESMD defined preliminary requirements and funded system-of-system definition studies by Government and industry. More than \$1 billion in technology tasks were immediately funded in a wide variety of areas. Plans were established to spend more than \$2 billion per year in exploration systems, human, and nuclear-related technologies. Plans were established to fund two CEV contractors through Preliminary Design Review (PDR) and first flight of a subscale test demonstration in 2008, after which selection of a final CEV contractor would be made. In March 2004, a CEV Request for Proposals (RFP) was released to industry despite the lack of a firm set of requirements or a preferred architecture approach for returning humans to the Moon. A wide variety of architecture options was still under consideration at that time—with none considered feasible within established budgets. Preferred architecture options relied on as many as nine launches for a single lunar mission and on modified versions of the United States Air Force (USAF) Evolved Expendable Launch Vehicles (EELVs) for launch of crew and cargo.

Dr. Michael Griffin was named the new NASA Administrator in April 2005. With concurrence from Congress, he immediately set out to restructure NASA’s Exploration Program by making its priority to accelerate the development of the CEV to reduce or eliminate the planned gap in U.S. human access to space. He established a goal for the CEV to begin operation in 2011 and to be capable of ferrying crew and cargo to and from the ISS. To make room for these priorities in the budget, Dr. Griffin decided to downselect to a single CEV contractor as quickly as possible and cancel the planned 2008 subscale test demonstration. He also decided to significantly reduce the planned technology expenditures and focus on existing technology and proven approaches for exploration systems development. In order to reduce the number of required launches and ease the transition after Space Shuttle retirement in 2010, Dr. Griffin also directed the Agency to carefully examine the cost and benefits of developing a Shuttle-derived Heavy-Lift Launch Vehicle (HLLV) to be used in lunar and Mars exploration. To determine the best exploration architecture and strategy to implement these many changes, the Exploration Systems Architecture Study (ESAS) team was established at NASA Headquarters (HQ) as discussed in **Section 1.1.2, Charter**, and **Section 1.1.3, Approach**.

1.1.2 Charter

The ESAS began on May 2, 2005, at the request of the NASA Administrator. The study was commissioned in a letter dated April 29, 2005, which is provided in **Appendix 2A, Charter for the Exploration Systems Architecture Study (ESAS)**, from the NASA Administrator to all NASA Center Directors and Associate Administrators. The study was initiated to perform four specific tasks by July 29, 2005, as outlined in the letter and identified below.

- Complete assessment of the top-level CEV requirements and plans to enable the CEV to provide crew transport to the ISS and to accelerate the development of the CEV and crew launch system to reduce the gap between Shuttle retirement and CEV Initial Operational Capability (IOC).
- Provide definition of top-level requirements and configurations for crew and cargo launch systems to support the lunar and Mars exploration programs.
- Develop a reference lunar exploration architecture concept to support sustained human and robotic lunar exploration operations.
- Identify key technologies required to enable and significantly enhance these reference exploration systems and reprioritize near-term and far-term technology investments.

More than 20 core team members were collocated at NASA HQ for the 3-month duration. Over the course of the ESAS effort, hundreds of employees from NASA HQ and the field centers were involved in design, analysis, planning, and costing activities.

1.1.3 Approach

The ESAS effort was organized around each of the four major points of the charter: CEV definition, Launch Vehicle (LV) definition, lunar architecture definition, and technology plan definition. Additional key analysis support areas included cost, requirements, ground operations, mission operations, human systems, reliability, and safety.

The ESAS team took on the task of developing new CEV requirements and a preferred configuration to meet those requirements. The CEV requirements developed by the ESAS team are contained in **Appendix 2B, ESAS CEV Requirements**. A wide variety of trade studies was addressed by the team. Different CEV shapes were examined, including blunt-body, slender-body, and lifting shapes. The required amount of habitable volume and number of crew were determined for each mission based on a crew task analysis. Economic-based trades were performed to examine the benefits of reusability and system commonality. The effects of a CEV mission to the ISS were examined in detail, including docking and berthing approaches and the use of the CEV as a cargo transport and return vehicle. The requirements for Extra-Vehicular Activity (EVA) were examined, and different airlock approaches were investigated. Additional trades included: landing mode, propellant type, number of engines, level of engine-out capability, and abort approaches. A phased development approach was defined that uses block upgrades of the CEV system for ISS crew, ISS cargo, lunar, and Mars missions with the same shape and size system.

The ESAS team examined hundreds of different combinations of launch elements to perform the various Design Reference Missions (DRMs). Different sizes of LVs and numbers of launches required to meet the DRMs were traded. The team's major trade study was a detailed examination of the costs, schedule, reliability, safety, and risk of using EELV- and Shuttle-derived launchers for crew and cargo missions. Other trade studies included: stage propellant type, numbers of engines per stage, level of stage commonality, and number of stages.

The ESAS team was tasked to develop new architecture-level requirements and an overall architecture approach to meet those requirements. The architecture requirements developed by the ESAS team are contained in **Appendix 2C, ESAS Architecture Requirements**. An initial reference architecture was established and configuration control was maintained by the team. Trade studies were then conducted from this initial baseline. In order to determine the crew and cargo transportation requirements, the team examined and traded a number of different lunar surface missions and systems and different approaches to constructing a lunar outpost. A team of nationally recognized lunar science experts was consulted to determine science content and preferred locations for sortie and outpost missions. The use of in-situ resources for propellant and power was examined, and nuclear and solar power sources were traded. The major trade study conducted by the team was an examination of various mission modes for transporting crew and cargo to the Moon, including: Lunar Orbit Rendezvous (LOR), Earth Orbit Rendezvous (EOR), and direct return from the lunar surface. The number and type of elements required to perform the Trans-Lunar Injection (TLI), Lunar-Orbit Insertion (LOI), and Trans-Earth Injection (TEI) burns associated with these missions were also traded. In addition, a number of different configurations were examined for the lunar lander, or Lunar Surface Access Module (LSAM). Trade studies for the LSAM included: number of stages, stage propellant and engine type, level of engine-out capability, airlock approaches, cargo capacity, and abort options.

The ESAS team was also tasked to determine the architecture technology requirements and to reprioritize existing technology plans to provide mature technologies prior to the PDR of each major element. The team used a disciplined, proven process to prioritize technology investments against architecture-level Figures of Merit (FOMs) for each mission. New technology investments were recommended only when required to enable a particular system, and investments were planned to begin only as required based on the need date.

The various trade studies conducted by the ESAS team used a common set of FOMs for evaluation. Each option was quantitatively or qualitatively assessed against the FOMs shown in **Figure 1-1**. FOMs are included in the areas of: safety and mission success, effectiveness and performance, extensibility and flexibility, programmatic risk, and affordability. FOMs were selected to be as mutually independent and measurable as possible. Definitions of each of these FOMs are provided in **Appendix 2D, ESAS FOM Definitions**, together with a list of measurable proxy variables and drivers used to evaluate the impacts of trade study options against the individual FOMs.

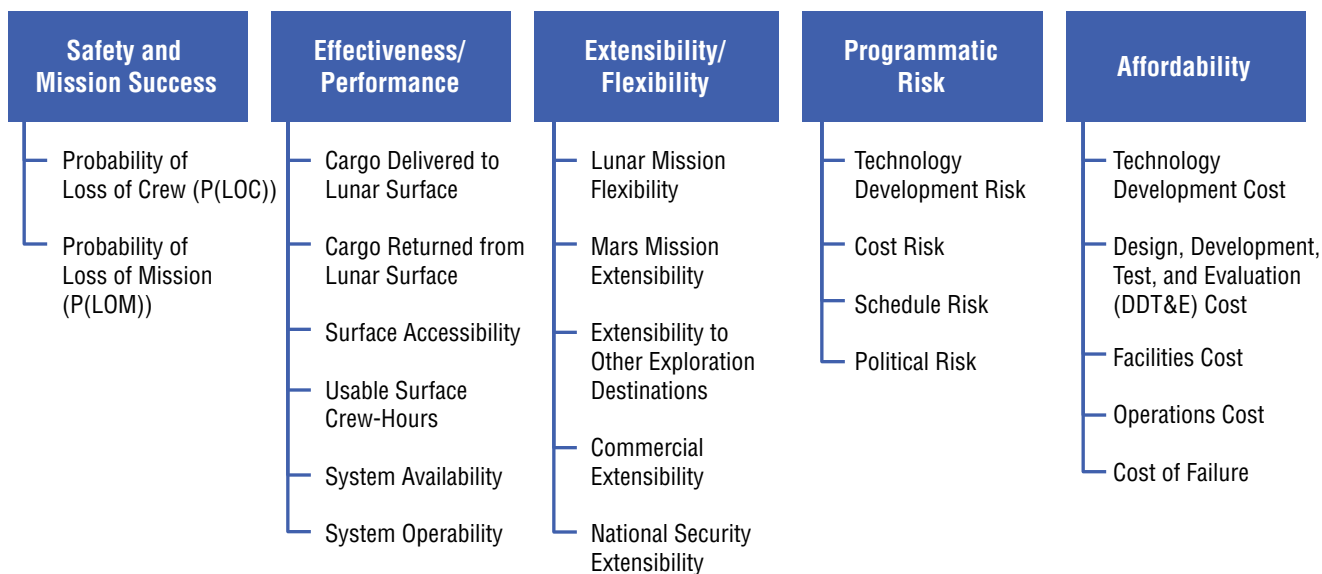

Figure 1-1. ESAS FOMs

1.1.4 Design Reference Missions

A series of DRMs was established to facilitate the derivation of requirements and the allocation of functionality between the major architecture elements. Three of the DRMs were for ISS-related missions: transportation of crew to and from the ISS, transportation of pressurized cargo to and from the ISS, and transportation of unpressurized cargo to the ISS. Three of the DRMs were for lunar missions: transportation of crew and cargo to and from anywhere on the lunar surface in support of 7-day “sortie” missions, transportation of crew and cargo to and from an outpost at the lunar south pole, and one-way transportation of cargo to anywhere on the lunar surface. A DRM was also established for transporting crew and cargo to and from the surface of Mars for a 18-month stay.

1.1.4.1 DRM Description: Crew Transport To and From ISS

The primary purpose of this mission is to transport three ISS crew members, and up to three additional temporary crew members, to the ISS for a 6-month stay and return them safely to Earth at any time during the mission. The architecture elements that satisfy the mission consist of a CEV and a Crew Launch Vehicle (CLV). **Figure 1-2** illustrates the mission. The CEV, consisting of a Crew Module (CM) and a Service Module (SM), is launched by the CLV into a 56- x 296-km insertion orbit at 51.6-deg inclination with a crew of three to six destined for a 6-month ISS expedition. The CEV performs orbit-raising burns per a pre-mission-defined rendezvous phasing profile to close on the ISS. These burns will be a combination of ground-targeted and onboard-targeted burns, the latter performed once rendezvous navigation sensors acquire the ISS. The CEV crew conducts a standard approach to the ISS, docking to one of two available CEV-compatible docking ports. The CEV crew pressurizes the vestibule between the two docked vehicles and performs a leak check. The ISS crew then equalizes pressure with the CEV vestibule and hatches are opened. Once ingress activities are complete, the CEV is configured to a quiescent state and assumes a “rescue vehicle” role for the duration of the crew increment. Periodic systems health checks and monitoring are performed by Mission Control throughout the increment. Upon completion of up to a 180-day increment on the ISS, the crew stows any return manifest items in the CEV crew cabin, performs a pre-undock health check of all entry critical systems, closes hatches and performs leak

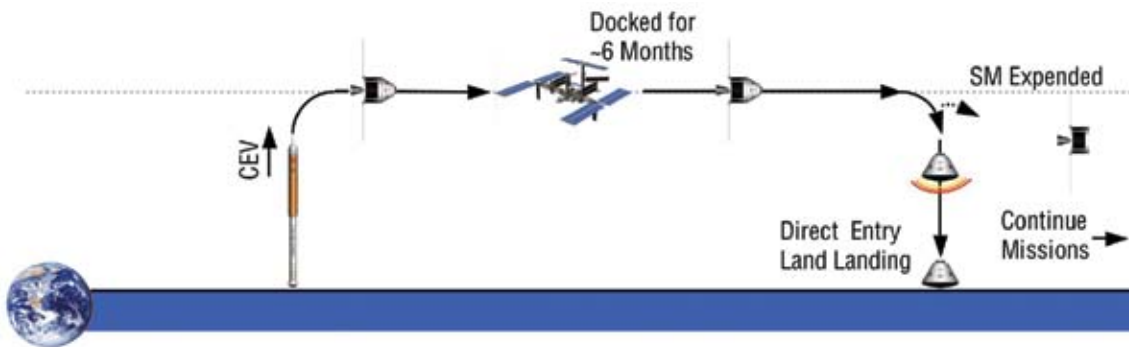

Figure 1-2. Crew Transport to and from ISS DRM

checks, and undocks from the station. The CEV departs the vicinity of the ISS and conducts an onboard-targeted (ground-validated) deorbit burn. After burn completion, the CEV SM is discarded, and the return component is maneuvered to the proper entry interface attitude for a guided entry to the landing site. The CEV performs a nominal landing at the primary land-based landing site.

1.1.4.2 DRM Description: Unpressurized Cargo Transport to ISS

The primary purpose of this mission is to transport unpressurized cargo to the ISS and de-orbit to perform a destructive reentry after 30 days at the ISS. The architecture elements that satisfy this mission consist of a Cargo Delivery Vehicle (CDV) and a CLV. **Figure 1-3** illustrates the mission. The CDV is launched by the CLV into a 56- x 296-km insertion orbit at 51.6-deg inclination with an unpressurized carrier in place of the CEV CM loaded with up to 6,000 kg gross mass of external ISS logistics. The CDV performs orbit-raising burns per a pre-mission-defined rendezvous phasing profile to close on the ISS. These burns will be a combination of ground-targeted and onboard-targeted burns, the latter to be performed once rendezvous navigation sensors acquire the ISS. The CDV performs a standard approach to a safe stationkeeping point in the vicinity of the ISS. Upon validation of readiness to proceed by Mission Control, the CDV is commanded to proceed with approach and conducts a standard onboard-guided approach to the ISS, achieving a stationkeeping point within reach of the Space Station Remote Manipulator System (SSRMS). The ISS crew grapples the CDV and berths it to the Node 2 nadir Common Berthing Mechanism (CBM) port. Once berthing activities are complete, the CDV systems are configured to a quiescent state. The ISS crew performs logistics transfer and systems maintenance EVAs to offload the CDV unpressurized pallet of new Orbital Replacement Units (ORUs) and to load old ORUs for disposal. Periodic systems health checks and monitoring are performed by Mission Control throughout the increment. Upon completion of up to a 30-day mated phase on the ISS, Mission Control performs a pre-undock health check of all entry critical systems. Then, the ISS crew grapples the CDV, unberths it from the CBM, and maneuvers it to its departure point and releases it. The CDV departs the vicinity of the ISS and conducts an onboard-targeted (ground-validated) deorbit burn for disposal.

Figure 1-3.
Unpressurized
Cargo Transport
to ISS DRM

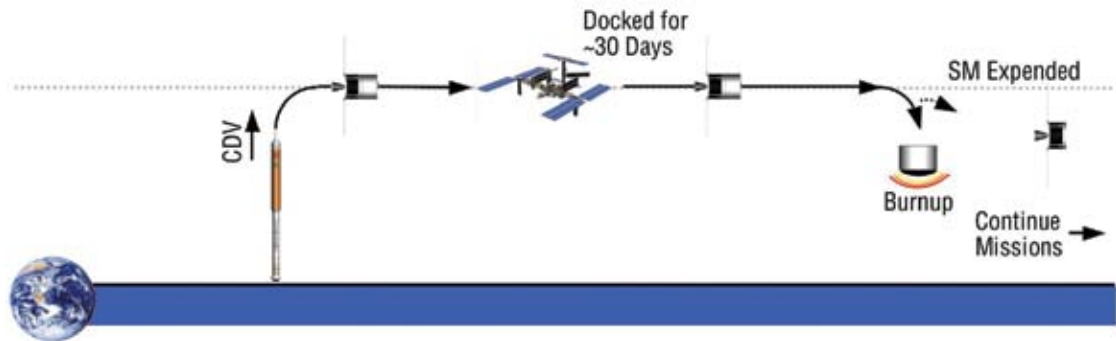

1.1.4.3 DRM Description: Pressurized Cargo Transport To and From ISS

The primary purpose of this mission is to transport pressurized cargo to the ISS and deorbit to perform a reentry and safe return of pressurized cargo to Earth after 90 days at the ISS.

Figure 1-4 illustrates the mission. The architecture elements that satisfy this mission consist of a cargo version of the CEV and a CLV. A cargo version of the CEV is launched by the CLV into a 56- x 296-km insertion orbit at 51.6-deg inclination with the pressurized module filled with up to 3,500 kg gross mass of pressurized logistics for delivery to the ISS. The CEV performs orbit-raising burns per a pre-mission-defined rendezvous phasing profile to close on the ISS. These burns will be a combination of ground-targeted and onboard-targeted burns, the latter performed once rendezvous navigation sensors acquire the ISS. The uncrewed CEV performs a standard approach to a safe stationkeeping point in the vicinity of the ISS. Upon validation of readiness to proceed by Mission Control, the CEV is commanded to proceed with approach and conducts a standard onboard-guided approach to the ISS, docking to one of two available CEV-compatible docking ports. Mission Control pressurizes the vestibule between the two docked vehicles and performs a leak check. The ISS crew then equalizes with the CEV and hatches are opened. Once ingress activities are complete, the CEV systems are configured to a quiescent state, and the CEV cargo is offloaded. Periodic systems health checks and monitoring are performed by Mission Control throughout the increment. Upon completion of up to a 90-day docked phase on the ISS, the crew stows any return manifest items in the CEV pressurized cabin, Mission Control performs a pre-undock health check of all entry critical systems, the ISS crew closes hatches and performs leak checks, and Mission Control commands the CEV to undock from the station. The CEV departs the vicinity of the ISS and conducts an onboard-targeted (ground-validated) deorbit burn. After burn completion, unnecessary CEV elements are discarded, and the return element is maneuvered to the proper entry interface attitude for a guided entry to the landing site. The CEV performs a nominal landing at the primary land-based landing site.

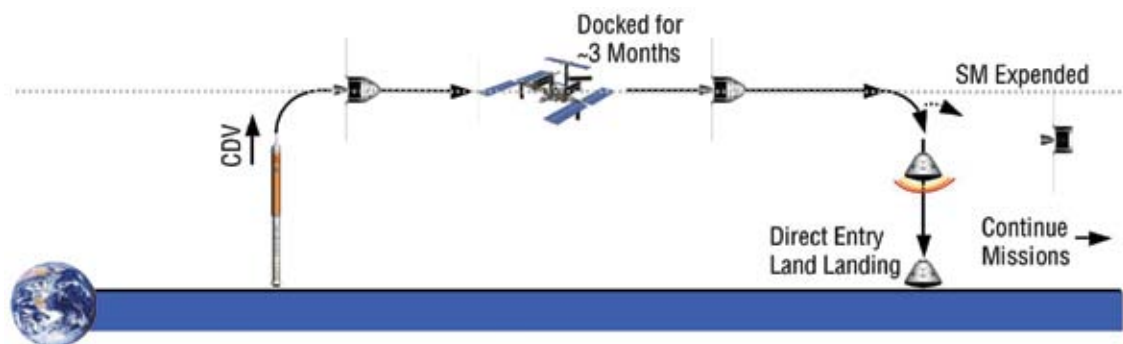

Figure 1-4. Pressurized
Cargo Transport to and
from ISS DRM

1.1.4.4 DRM Description: Lunar Sortie Crew with Cargo

The architecture provides the capability for up to four crew members to explore any site on the Moon (i.e., global access) for up to 7 days. These missions, referred to as lunar sorties, are analogous to the Apollo surface missions and demonstrate the capability of the architecture to land humans on the Moon, operate for a limited period on the surface, and safely return them to Earth. Sortie missions also allow for exploration of high-interest science sites or scouting of future lunar outpost locations. Such a mission is assumed not to require the aid of pre-positioned lunar surface infrastructure, such as habitats or power stations, to perform the mission. During a sortie, the crew has the capability to perform daily EVAs with all crew members egressing from the vehicle through an airlock. Performing EVAs in pairs with all four crew members on the surface every day maximizes the scientific and operational value of the mission.

Figure 1-5 illustrates the lunar sortie crew and cargo mission. The following architecture elements are required to perform the mission: a CLV, a Cargo Launch Vehicle (CaLV) capable of delivering at least 125 mT to Low Earth Orbit (LEO), a CEV, an LSAM, and an Earth Departure Stage (EDS). The assumed mission mode for the lunar sortie mission is a combination EOR–LOR approach. The LSAM and EDS are predeployed in a single CaLV launch to LEO, and the CLV delivers the CEV and crew in Earth orbit, where the two vehicles initially rendezvous and dock. The EDS performs the TLI burn and is discarded. The LSAM then performs the LOI for both the CEV and LSAM. The entire crew then transfers to the LSAM, undocks from the CEV, and performs a descent to the lunar surface in the LSAM. After up to 7 days on the lunar surface, the LSAM returns the crew to lunar orbit where the LSAM and CEV dock, and the crew transfers back to the CEV. The CEV then returns the crew to Earth with a direct entry and land touchdown, while the LSAM is disposed of via impact on the lunar surface.

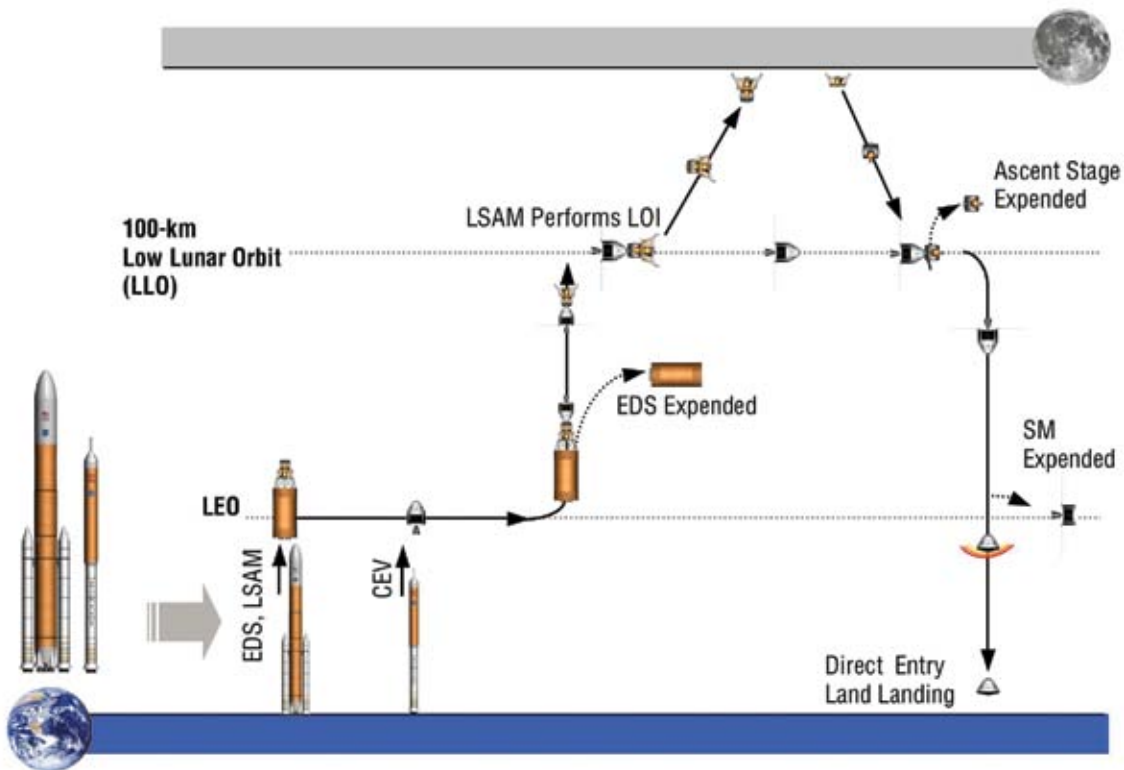

Figure 1-5. Lunar Sortie Crew with Cargo DRM

1.1.4.5 DRM Description: Lunar Outpost Cargo Delivery

The architecture provides the capability to deliver 20 mT of cargo to the lunar surface in a single mission using the elements of the human lunar transportation system. This capability is used to deliver surface infrastructure needed for lunar outpost buildup (habitats, power systems, communications, mobility, In-Situ Resource Utilization (ISRU) pilot plants, etc.), as well as periodic logistics resupply packages to support a continuous human presence.

Figure 1-6 illustrates the lunar outpost cargo delivery mission. The following architecture elements are required to perform the mission: the same CaLV and EDS as the sortie mission and a cargo variant of the LSAM to land the large cargo elements near the lunar outpost site. The cargo variant of the LSAM replaces the habitation module with a cargo pallet and logistics carriers. The LSAM and EDS are launched to LEO on a single CaLV. The EDS performs the TLI burn and is discarded. The LSAM then performs the LOI and a descent to the lunar surface. The cargo is then offloaded from the LSAM autonomously or by the outpost crew.

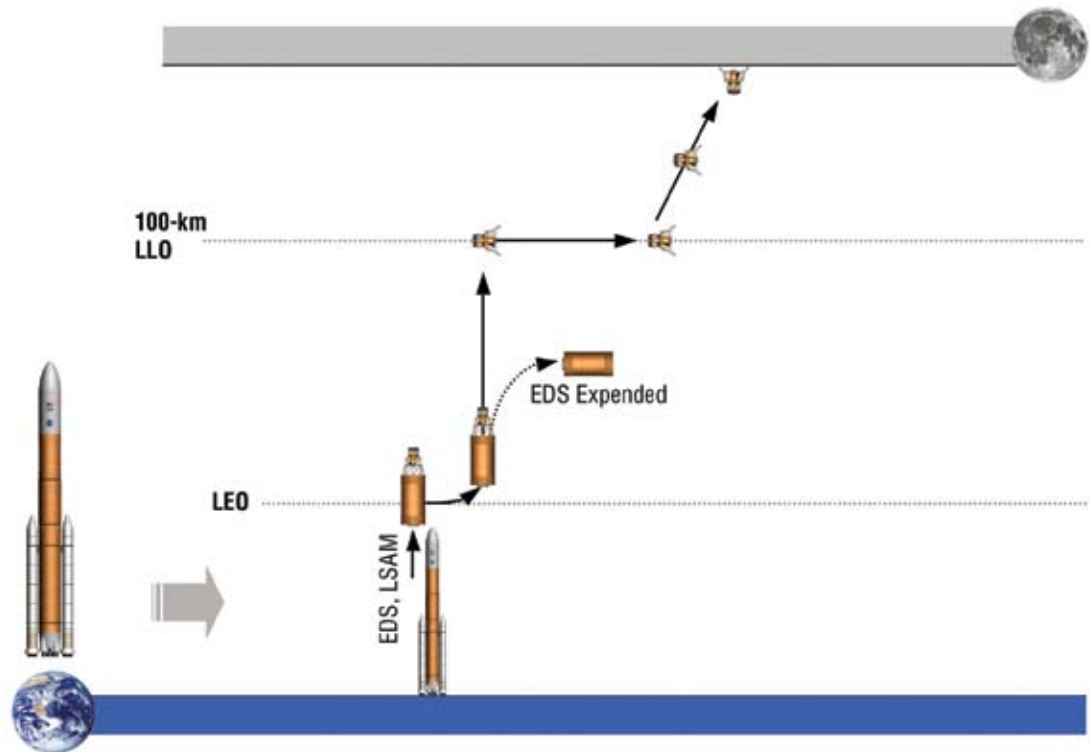

Figure 1-6. Lunar Outpost Cargo Delivery DRM

1.1.4.6 DRM Description: Lunar Outpost Crew with Cargo

A primary objective of the lunar architecture is to establish a continuous human presence on the lunar surface to accomplish exploration and science goals. This capability will be established as quickly as possible following the return of humans to the Moon. To best accomplish science and ISRU goals, the outpost is expected to be located at the lunar south pole. The primary purpose of the mission is to transfer up to four crew members and supplies in a single mission to the outpost site for expeditions lasting up to 6 months. Every 6 months, a new crew will arrive at the outpost, and the crew already stationed there will return to Earth. **Figure 1-7** illustrates this mission.

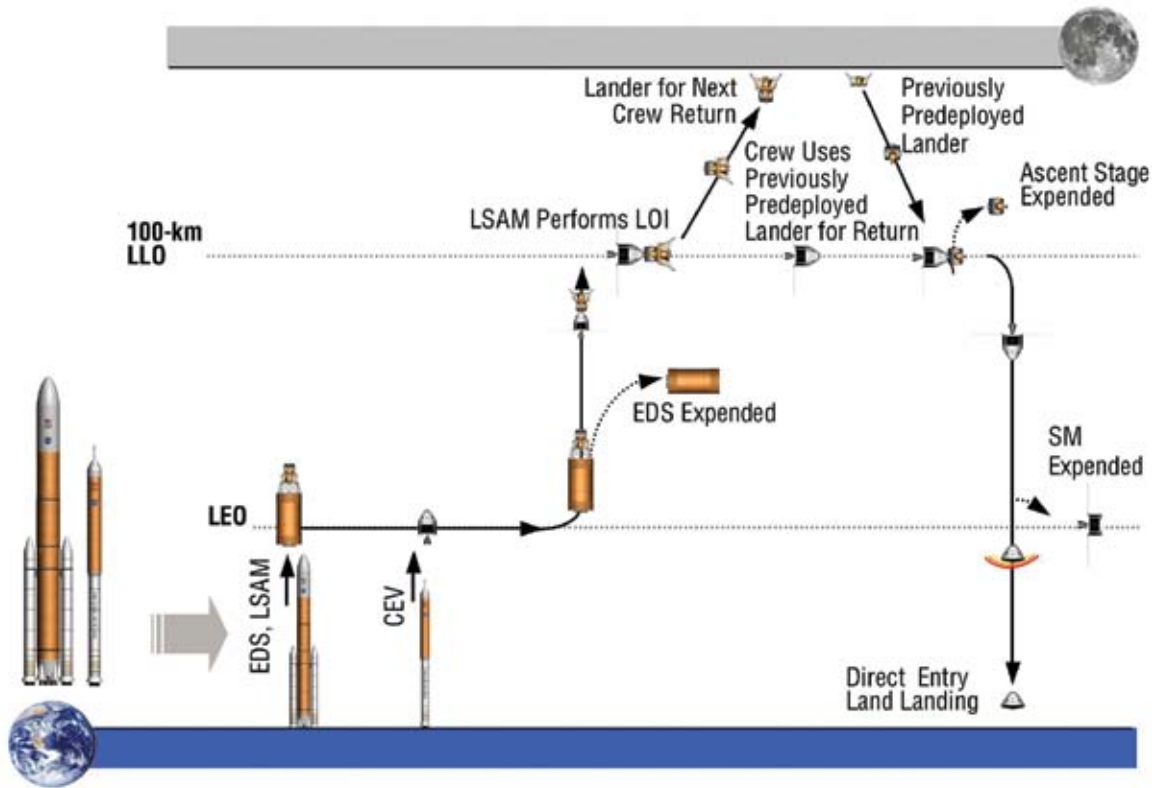

Figure 1-7. Lunar Outpost Crew with Cargo DRM

The entire suite of vehicles developed to support lunar sortie exploration is also required for lunar outpost missions, in addition to a surface habitat, power/communications systems, and other infrastructure elements still to be defined. The following architecture elements are required to perform the mission: a CLV, a CaLV capable of delivering at least 125 mT to LEO, a CEV, an LSAM, and an EDS. The assumed mission mode for the lunar sortie mission is a combination EOR–LOR approach. The LSAM and EDS are predeployed in a single CaLV launch to LEO, and the CLV delivers the CEV and crew in Earth orbit, where the two vehicles initially rendezvous and dock. The EDS performs the TLI burn and is discarded. The LSAM then performs the LOI for both the CEV and LSAM. The entire crew then transfers to the LSAM, undocks from the CEV, and performs a descent to the lunar surface near the outpost in the LSAM. After a surface stay of up to 6 months, the LSAM returns the crew to lunar orbit where the LSAM and CEV dock, and the crew transfers back to the CEV. The CEV then returns the crew to Earth with a direct entry and land touchdown, while the LSAM is disposed of via impact on the lunar surface.

1.1.4.7 DRM Description: Mars Exploration

The Mars Exploration DRM employs conjunction-class missions, often referred to as long-stay missions, to minimize the exposure of the crew to the deep-space radiation and zero-gravity environment while, at the same time, maximizing the scientific return from the mission. This is accomplished by taking advantage of optimum alignment of Earth and Mars for both the outbound and return trajectories by varying the stay time on Mars, rather than forcing the mission through non-optimal trajectories, as in the case of the short-stay missions. This approach allows the crew to transfer to and from Mars on relatively fast trajectories, on the order of 6 months, while allowing them to stay on the surface of Mars for a majority of the mission, on the order of 18 months. **Figure 1-8** provides an overview of the mission approach.

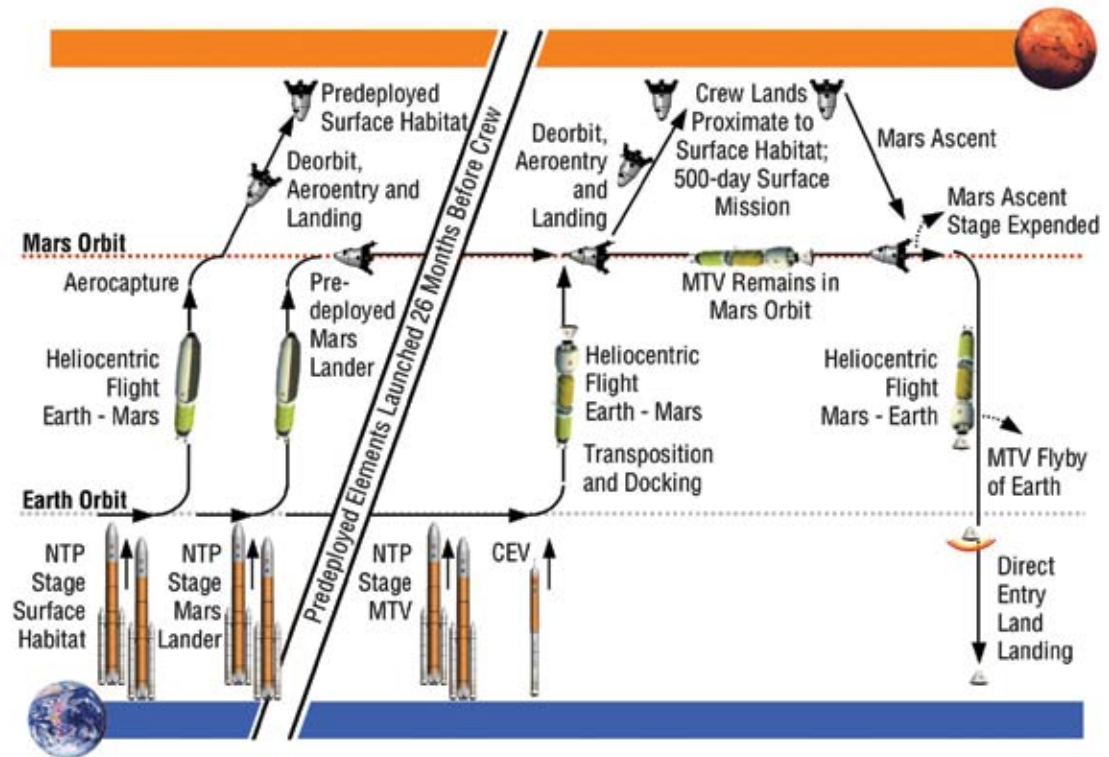

Figure 1-8. Mars Exploration DRM

The surface exploration capability is implemented through a split mission concept in which cargo is transported in manageable units to the surface, or Mars orbit, and checked out in advance of committing the crews to their mission. The split mission approach also allows the crew to be transported on faster, more energetic trajectories, minimizing their exposure to the deep-space environment, while the vast majority of the material sent to Mars is sent on minimum energy trajectories. As can be seen in **Figure 1-8**, each human mission to Mars is comprised of three vehicle sets, two cargo vehicles, and one round-trip piloted vehicle.

The scope of the ESAS was only to address the transportation of the crew to a Mars Transfer Vehicle (MTV) in LEO or reentering from the MTV at the conclusion of the Mars mission, and to provide the design of a CaLV with an LEO cargo capacity of 125 mT.

This DRM utilizes the CEV to transfer a crew of six to and from an MTV as part of a Mars mission architecture. The CEV is launched by the CLV into an orbit matching the inclination of the MTV. The CEV spends up to 2 days performing orbit-raising maneuvers to close on the MTV. The CEV crew conducts a standard approach to the MTV and docks. The CEV crew performs a leak check, equalizes pressure with the MTV, and opens hatches. Once crew and cargo transfer activities are complete, the CEV is configured to a quiescent state. Periodic systems health checks and monitoring are performed by Mission Control throughout the Mars transfer mission.

As the MTV approaches Earth upon completion of the 2.5-year mission, the crew performs a pre-undock health check of all entry critical systems, transfers to the CEV, closes hatches, performs leak checks, and undocks from the MTV. The CEV departs the MTV 24 hours prior to Earth entry and conducts an onboard-targeted (ground-validated) deorbit burn. As entry approaches, the CEV maneuvers to the proper entry interface attitude for a direct guided entry to the landing site. The CEV performs a nominal landing at the primary land-based landing site.

1.2 Ground Rules and Assumptions

At the beginning of the ESAS, a number of Ground Rules and Assumptions (GR&As) were established based on management guidance, internal and external constraints, design practices, and existing requirements.

1.2.1 Safety and Mission Assurance (S&MA) GR&As

The S&MA GR&As are listed below.

- NASA Procedural Requirements (NPR) 8705.2, Human-Rating Requirements for Space Systems, will be used as a guideline for all architecture design activities. Required deviations from NPR 8705.2 will be noted in the applicable requirements documentation.
- Abort opportunities will be provided throughout all mission phases to the maximum extent possible.
- In the event of an abort from the lunar surface, return of crew to the Earth's surface will take no longer than 5 days—independent of orbital alignment.

1.2.2 Operations GR&As

The Operations GR&As are listed below.

- The CEV will deliver crew to and from the ISS through ISS end-of-life in 2016.
- The CEV will deliver and return cargo to the ISS through ISS end-of-life in 2016.
- The architecture will separate crew and large cargo to the maximum extent practical.
- The architecture will support ISS up/down mass needs and other ISS requirements, as required, after Shuttle retirement.
- CEV operations will be performed at the Kennedy Space Center (KSC) through clearing of the launch pad structure.
- On-orbit flight operations and in-flight operations for crewed missions will be performed at NASA JSC.
- Crew and cargo recovery operations from the crew and cargo launches will be managed by KSC with assistance from other NASA and non-NASA personnel and assets as required.
- Architectures will enable extensibility of lunar mission systems to human Mars exploration missions.
- The study will utilize the Mars DRM known as DRM 3.0, “Reference Mission Version 3.0 Addendum to the Human Exploration of Mars: The Reference Mission of the NASA Mars Exploration Study Team EX13-98-036, June 1998.”
- The architecture will support lunar global access.
- The architecture will support a permanent human presence on the Moon.
- In-space EVA assembly will not be required.
- In-space EVA will only be performed as a contingency operation.
- Human-rated EELV-derived LVs will require new dedicated launch pads.

1.2.3 Technical GR&As

The Technical GR&As are listed below.

- The CEV will be designed for up to a crew of six for ISS missions.
- The CEV will be designed for up to a crew of four for lunar missions.
- The CEV will be designed for up to a crew of six for Mars missions.
- The CEV to support the lunar and Mars exploration missions and the ISS missions will use a single Outer Mold Line (OML) for the entry vehicle.
- Architectures will be designed for the lunar and Mars exploration missions and modified as required to support ISS missions.
- No more than four launches will be used to accomplish a single human lunar mission. This does not include infrastructure launches or supporting logistics.
- The following inert weight contingencies will be used:
 - Zero percent (0%) for existing LV elements with no planned specification change and no anticipated modifications (e.g., Space Shuttle Main Engine (SSME), RS-68, RD-180);
 - Five percent (5%) on existing LV elements requiring minimal modifications (e.g., External Tank (ET), Orbiter aft structure, EELV boosters, upper stages, and shrouds);
 - Ten percent (10%) on new Expendable Launch Vehicle (ELV) elements with direct Shuttle or EELV heritage;
 - Fifteen percent (15%) on new ELV elements with no heritage; and
 - Twenty percent (20%) on new in-space elements with no heritage (e.g., CEV, LSAM).
- Additional margins and factors of safety include the following:
 - Thirty percent (30%) margin for average power;
 - Two percent (2%) margin for reserves and residuals mass;
 - Two percent (2%) propellant tank ullage fractions for LV stages;
 - Fuel bias of nominal mixture ratio * 0.000246 * usable propellant weight;
 - A 2.0 factor of safety for crew cabins;
 - A 1.5 factor of safety on burst pressure for fluid pressure vessels;
 - A 1.4 ultimate factor of safety on all new or redesigned structures;
 - A 1.25 factor of safety on proof pressure for fluid pressure vessels;
 - Ten percent (10%) margin for rendezvous delta-Vs;
 - One percent (1%) ascent delta-V margin on LVs to account for dispersions;
 - Ten percent (10%) payload margin on all LV payload delivery predictions; and
 - Five percent (5%) additional payload margin on CaLV delivery predictions to account for Airborne Support Equipment (ASE).
- Technologies will be Technology Readiness Level-Six (TRL-6) or better by PDR.

1.2.4 Cost GR&As

The Cost GR&As are listed below.

- There will be only one CEV contractor after Calendar Year 2005 (CY05).
- There will be no 2008 CEV flight demonstration as originally planned.
- All Life Cycle Cost (LCC) estimates will include best-effort estimates of “full-cost” impacts (including corporate General and Administrative (G&A) at 5%, Center G&A, Center Civil Service salaries, travel, overhead, and Center service pool costs).
- Cost estimates will use 20 percent reserves for development.
- Cost estimates will use 10 percent reserves for operations.
- Cost estimates will use the April 2005 NASA New Start Inflation Index.

1.2.5 Schedule GR&As

The Schedule GR&As are listed below.

- There is a goal of 2011 for the first CEV human flight to ISS.
- There is a goal of performing the next human lunar landing by 2020—or as soon as practical.

1.2.6 Testing GR&As

The Testing GR&As are listed below.

- Ground Element Qualification
 - Elements will have ground qualification tests to demonstrate readiness for manned flight.
 - Multi-element integrated tests will be performed to demonstrate readiness for manned flight.
- Element Flight Qualification
 - Qualification of the CEV requires a minimum of one flight demonstrating full functionality prior to crewed flights.
 - Qualification of the LSAM requires a minimum of one flight demonstrating full functionality prior to lunar landing.
 - Qualification of any crewed LV requires three flight tests for human certification prior to crewed flight.
 - Qualification of any CaLV requires one flight test prior to flight of high-value cargo.
- Integrated System Qualification
 - Qualification of the EDS for firing while mated to a crewed element requires a minimum of two flights to demonstrate full functionality prior to crewed flight.
 - Lunar mission rehearsal in-space with appropriate architecture elements and crew is required prior to attempting a lunar landing.

1.2.7 Foreign Assets GR&As

- Foreign assets utilized in LV configurations in this study will be assumed to be licensed and produced in the United States.

1.3 Lunar Architecture

1.3.1 Introduction

As defined by this study, the lunar architecture is a combination of the lunar transportation “mission mode,” the assignment of functionality to flight elements to perform the crewed lunar missions, and the definition of the activities to be performed on the lunar surface. The trade space for the lunar “mission mode,” or approach to performing the crewed lunar missions, was limited to the cislunar space and Earth-orbital staging locations, the lunar surface activities duration and location, and the lunar abort/return strategies.

The mission mode analysis was built around a matrix of lunar- and Earth-staging nodes. Lunar-staging locations initially considered included the Earth-Moon L1 libration point, Low Lunar Orbit (LLO), and the lunar surface. Earth-orbital staging locations considered included due-east LEOs, higher-inclination ISS orbits, and raised apogee High Earth Orbits (HEOs). Cases that lack staging nodes (i.e., “direct” missions) in space and at Earth were also considered.

This study addressed lunar surface duration and location variables (including latitude, longitude, and surface stay-time) and made an effort to preserve the option for full global landing site access. Abort strategies were also considered from the lunar vicinity. “Anytime return” from the lunar surface is a desirable option that was analyzed along with options for orbital and surface loiter.

Definition of surface activities was equal in weight to the mission mode study. The duration, location, and centralization of lunar surface activities were analyzed by first determining the content of the science, resource utilization, Mars-forward technology demonstrations, and operational tests that could be performed during the lunar missions. The study looked at high-priority landing sites and chose a reference site in order to further investigate the operations at a permanent outpost. With the scientific and engineering activities defined, concept-level approaches for the deployment and buildup of the outpost were created. A comprehensive definition of lunar surface elements and infrastructure was not performed because development activities for lunar surface elements are still years in the future. Therefore, the ESAS team concentrated its recommendations on those elements that had the greatest impact on near-term decisions.

Additional details on the lunar architecture trade studies and analysis results are contained in **Section 4, Lunar Architecture**, of this report.

1.3.2 Lunar Mission Mode Analysis

1.3.2.1 Option Analysis Approach

The lunar mission mode option space considered the location of “nodes” in both cislunar space and the vicinity of Earth. The study originally considered cislunar nodes at the Earth-Moon L1 libration point, in LLO, and on the lunar surface. Respectively, these translate to Libration Point Rendezvous (LPR), LOR, and Lunar Surface Rendezvous (LSR) mission modes. The study also considered Earth-orbital staging locations in LEO, higher-inclination ISS orbits, and raised-apogee HEOs. In all three cases, elements brought together in any type of Earth orbit were generically termed an EOR mission mode. In the case of both cislunar and Earth orbital nodes, a mission type that bypassed a node completely was termed a “direct” mission or the term for the bypassed node was omitted altogether. Therefore, the Apollo

missions were “direct” injection from Earth to the Moon, due to there being no EOR activities, and they were LOR at the Moon, owing to the rendezvous of the Command Module and Lunar Module (LM) following the surface mission. The Apollo mission mode was therefore popularly referred to as LOR.

LPR was eliminated early from the mission mode trade space. Recent studies performed by NASA mission designers concluded that equivalent landing site access and “anytime abort” conditions could be met by rendezvous missions in LLO with less propulsive delta-V and lower overall Initial Mass in Low Earth Orbit (IMLEO). If used only as a node for lunar missions, the L1 Earth-Moon LPR is inferior to the LOR mission mode.

With LPR eliminated, the mission mode question could be illustrated in a simple 2x2 matrix with the axes indicating the existence (or not) of an Earth orbital and lunar orbital node. The mission mode taxonomy could then be associated with each cell in this matrix—a mission that required EOR as well as rendezvous in lunar orbit was termed “EOR–LOR.” A mission that injected directly to the Moon (bypassing Earth orbital operations) and returned directly from the surface of the Moon (bypassing lunar orbital operations) was termed “direct-direct.” **Figure 1-9** illustrates the lunar mission mode matrix.

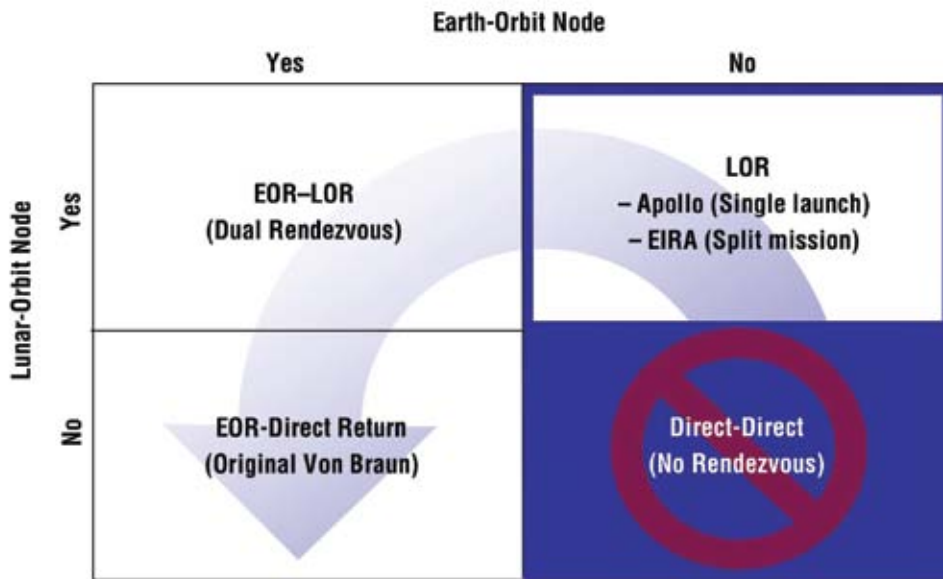

Figure 1-9. Lunar Mission Mode Taxonomy

This matrix becomes clearer when additional descriptions and certain historical lunar missions are added to the respective quadrants. The EOR-direct return mission (lower left-hand quadrant) was the mode favored by Wernher Von Braun early in the Apollo Program, while LOR (upper right-hand quadrant) was the mode eventually chosen. It became clear early in the ESAS analysis that the direct-direct mode (lower right-hand quadrant) would only be possible if the single LV it required had performance upwards of 200 mT to LEO. Because no LVs of this size were contemplated for this study due to cost and ground operations constraints, direct-direct was eliminated as a mission mode. The three remaining mission modes (LOR, EOR–LOR, and EOR-direct return) were analyzed in significant detail.

The EOR-direct return mission mode was examined for several analysis cycles but was eliminated from further consideration prior to the end of the study. In the direct return mode, the CEV must operate in, and transition among, 1-g prelaunch and post-landing, hyper-gravity launch, zero-gravity orbital and cruise, powered planetary landing and ascent, and 1/6-g lunar surface environments. This added significant complexity to a vehicle that must already perform a diverse set of functions in a diverse number of acceleration environments. Additionally, commonality of the SM between lunar and ISS configurations is further reduced in this case. The direct return lunar SM provides lunar ascent and TEI delta-V in excess of 2,400 m/s, the LOR SM is of the order of 1,850 m/s, and the ISS mission requires only 330 m/s. The direct return CEV also requires no docking mechanism since the CEV is the lone crew cabin for the round-trip mission. Conversely, this reduced the commonality from the ISS to the lunar CEV. Ultimately, the ESAS team concluded that the direct return mode entails the greatest number of operability issues and uncertainties, most notably to the configuration of the CEV, and that the complexities of a CEV designed for a surface-direct mission will increase the cost and schedule risks for delivering an ISS-compatible vehicle in the 2011–2012 time frame. Thus, the study team eliminated direct return on the basis of CEV complexity, poor margins, greatest number of operability issues and uncertainties, and highest sensitivity to mass growth.

1.3.2.2 Preferred Mission Mode Options

Mission mode analysis was performed in multiple cycles, with each cycle resulting in performance, cost, reliability, safety, and other FOMs with which to compare the mission options. At the end of each analysis cycle, decisions were made to eliminate certain mission modes or to perform additional studies to further drive out the differences among the options. A baseline was first chosen against which all design options could be compared. The baseline chosen by the ESAS team was a 2-launch LOR split mission termed the ESAS Initial Reference Architecture (EIRA).

For the final analysis cycle, the EIRA mission architecture was compared to a 2-launch EOR–LOR approach, which used two launches of a 100-mT LEO payload vehicle, and a “1.5-launch” EOR–LOR approach, which used a launch of a 125-mT LEO cargo vehicle and a smaller CLV. They were also compared for three different levels of propulsion technology. The baseline option used pressure-fed Liquid Oxygen (LOX)/methane engines on the CEV SM and the lander ascent and descent stages to maximize commonality. A second option substituted a pump-fed LOX/hydrogen system on the lander descent stage to improve performance. The third option also used LOX/hydrogen for the lander descent stage and substituted a pump-fed LOX/methane system for the ascent stage propulsion system.

The three final mission mode candidates are described in the following paragraphs.

1.3.2.2.1 EIRA 2-launch LOR Split Mission Architecture

The assumed mission mode for the EIRA is a 2-launch “split” architecture with LOR, wherein the LSAM is predeployed in a single launch to LLO and a second launch of the same vehicle delivers the CEV and crew in lunar orbit where the two vehicles initially rendezvous and dock. The entire crew then transfers to the LSAM, undocks from the CEV, and performs descent to the surface. The CEV CM and SM are left unoccupied in LLO. After a lunar stay of up to 7 days, the LSAM returns the crew to lunar orbit and docks with the CEV, and the crew transfers back to the CEV. The CEV then returns the crew to Earth with a direct-entry-and-land touchdown, while the LSAM is disposed of on the lunar surface. This mission mode is illustrated in **Figure 1-10**.

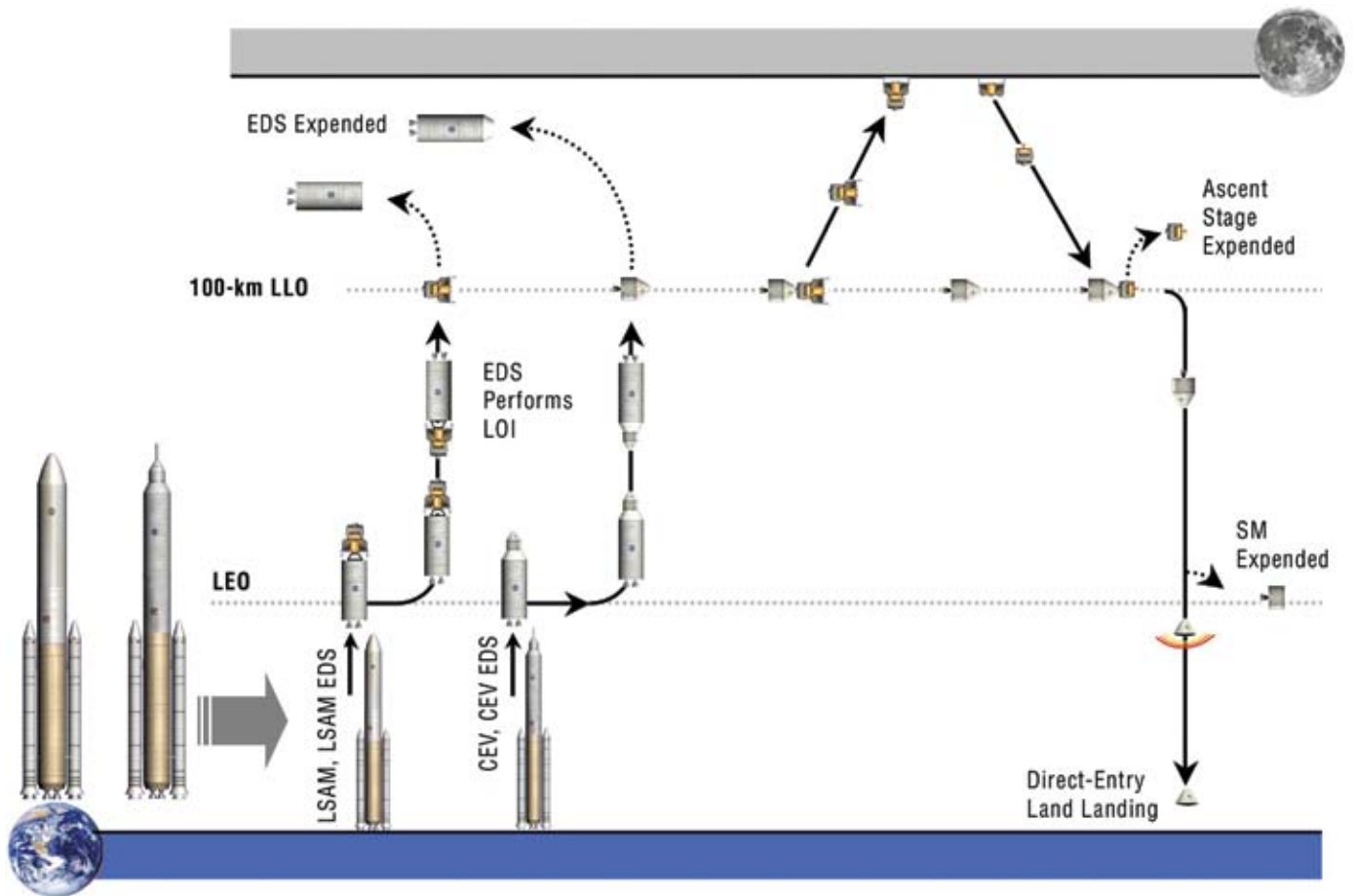

1.3.2.2.2 2-launch EOR–LOR Mission Architecture

The EOR–LOR architecture (**Figure 1-11**) is functionally similar to the EIRA, with the primary difference being that the initial CEV–LSAM docking occurs in LEO rather than LLO. Whereas the EIRA incorporated two smaller EDSs in two launches to deliver the CEV and LSAM to the Moon, the EOR–LOR architecture divides its launches into one launch for a single, large EDS and the second launch for the CEV, crew, and LSAM. The combined CEV and LSAM dock with the EDS in Earth orbit, and the EDS performs TLI. Another difference between the EIRA and EOR–LOR architectures is that, for the baseline pressure-fed LOX/methane propulsion system, the EDS performs LOI for the EIRA. Due to launch performance limitations of the single EDS with EOR–LOR, LOI is instead executed by the CEV for optimum performance. Once the CEV and LSAM reach LLO, this mission mode is identical to the EIRA.

Figure 1-10. EIRA 2-launch LOR Split Mission Architecture

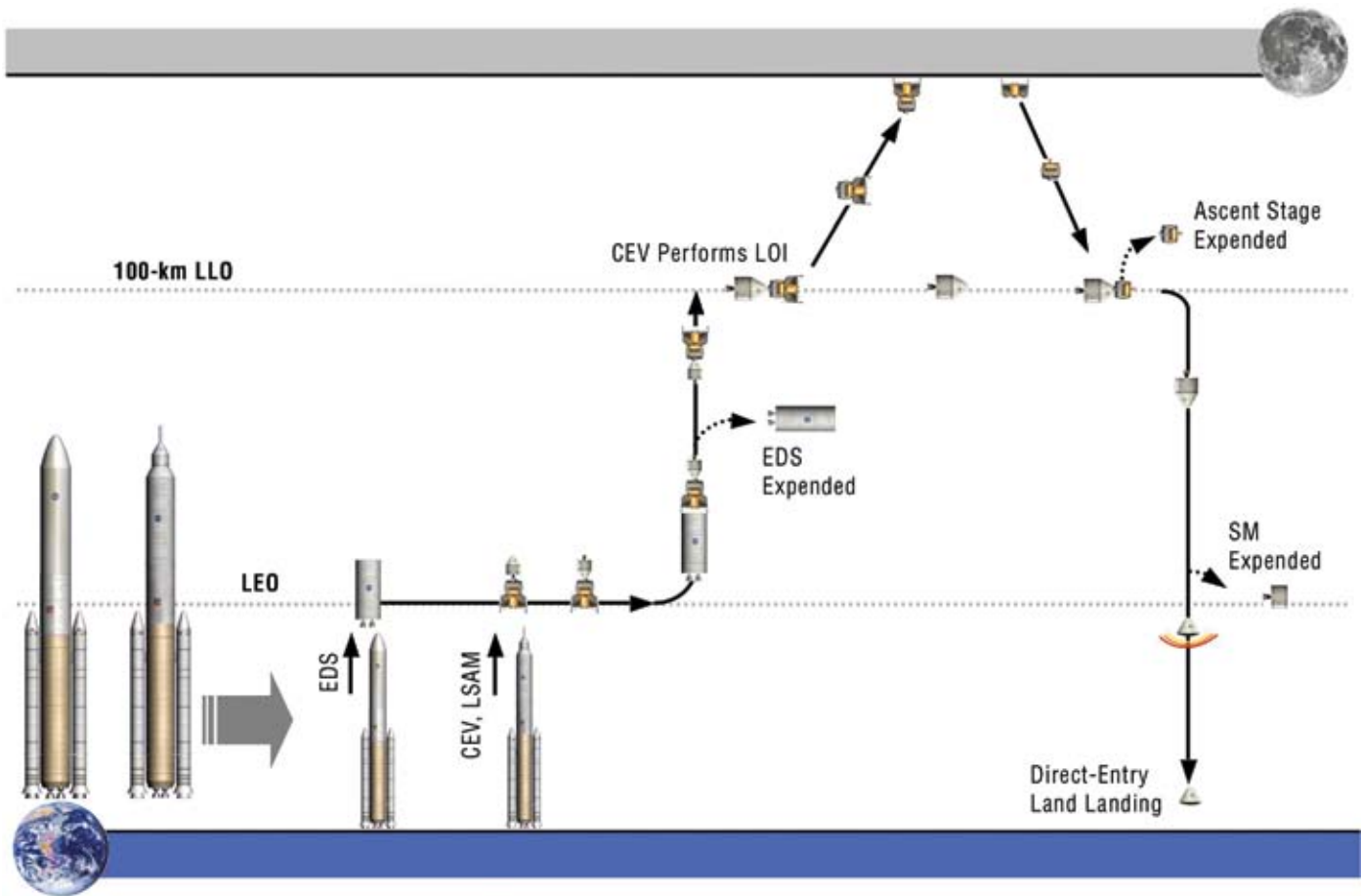

Figure 1-11. 2-launch EOR-LOR Mission Architecture

1.3.2.2.3 1.5-Launch EOR-LOR Mission Architecture

The use of LOX/hydrogen propulsion on the lander reduces the architecture masses sufficiently to enable a second EOR-LOR option. This variant, known as 1.5-launch EOR-LOR, is so named due to the large difference in size and capability of the LVs used in the architecture. Whereas the previous architectures have used one heavy-lift CaLV to launch cargo elements and another heavy-lift CLV to launch the CEV and crew, this architecture divides its launches between one large and one relatively small LV. The 1.5-launch EOR-LOR mission is an EOR-LOR architecture with the LSAM and EDS predeployed in a single launch to LEO with the heavy-lift CaLV. A second launch of a 25-mT-class CLV delivers the CEV and crew to orbit, where the two vehicles initially rendezvous and dock. The EDS then performs the TLI burn for the LSAM and CEV and is discarded. Upon reaching the Moon, the LSAM performs the LOI for the two mated elements, and the entire crew transfers to the LSAM, undocks from the CEV, and performs descent to the surface. The CEV is left unoccupied in LLO. After a lunar stay of up to 7 days, the LSAM returns the crew to lunar orbit, where the LSAM and CEV dock and the crew transfers back to the CEV. The CEV then returns the crew to Earth with a direct- or skip-entry-and-land touchdown, while the LSAM is disposed of via impact on the lunar surface. The 1.5-launch EOR-LOR architecture is illustrated in **Figure 1-12**.

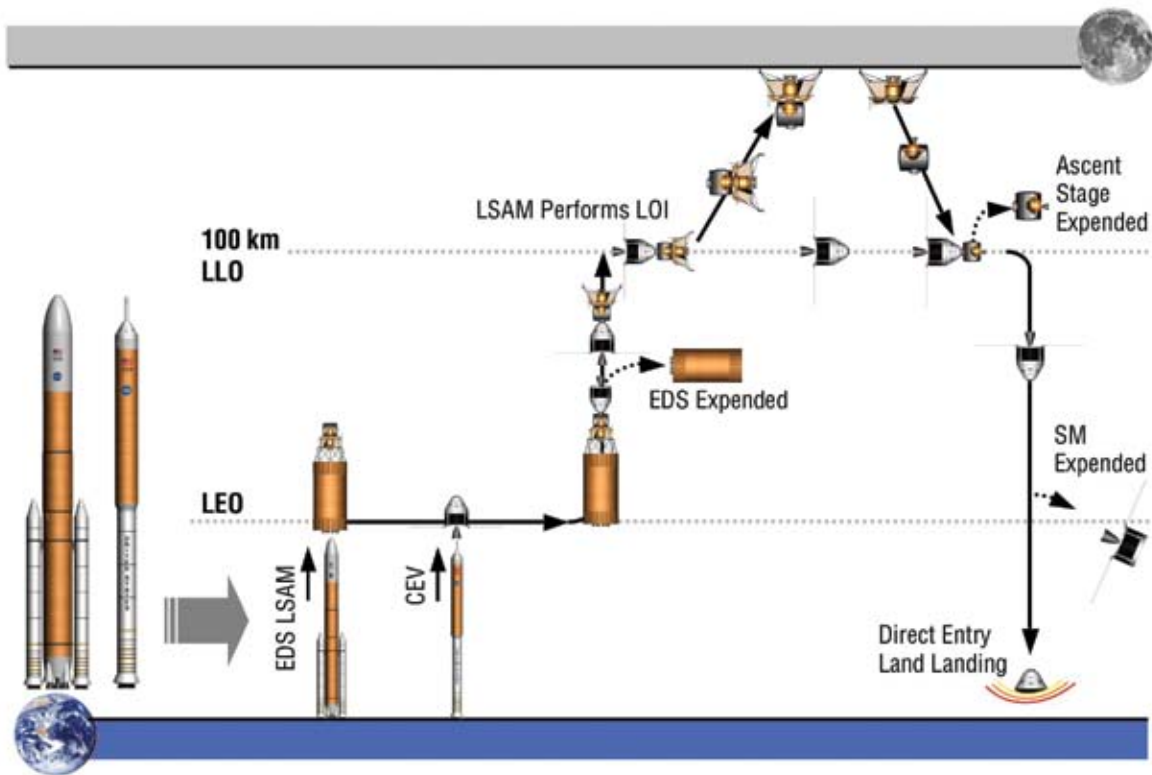

Figure 1-12. 1.5-Launch EOR-LOR Mission Architecture

1.3.2.3 Mission Mode Analysis Results

The team generated mission performance analysis for each option (IMLEO, number of launches required, and launch margins), integrated program costs through 2025, safety and reliability estimates (Probability of Loss of Crew (P(LOC)), and Probability of Loss of Mission (P(LOM)), and other discriminating FOMs.

1.3.2.3.1 Safety and Reliability

Three mission modes were analyzed, with three different propulsion technologies applied. In addition to the LOR, EOR-LOR “2-launch,” and EOR-LOR “1.5-launch” modes, analysis was also performed on a single-launch mission that launched both the CEV and lander atop a single heavy-lift CaLV (the same used for the 1.5-launch solution), much like the Apollo/Saturn V configuration. However, the limited lift capability provided by this approach limited its landing site capabilities to the same equatorial band explored by Apollo, in addition to the lunar poles. For each of the mission modes, end-to-end single-mission probabilities of LOC and LOM were calculated for (1) a baseline propulsive case using all pressure-fed LOX/methane engines, (2) a case where a LOX/hydrogen pump-fed engine was substituted on the lander descent stage, and (3) a third case where the lander ascent stage engine was changed to pump-fed LOX/methane. **Figures 1-13 and 1-14** illustrate the P(LOC) and P(LOM) for each of these cases.

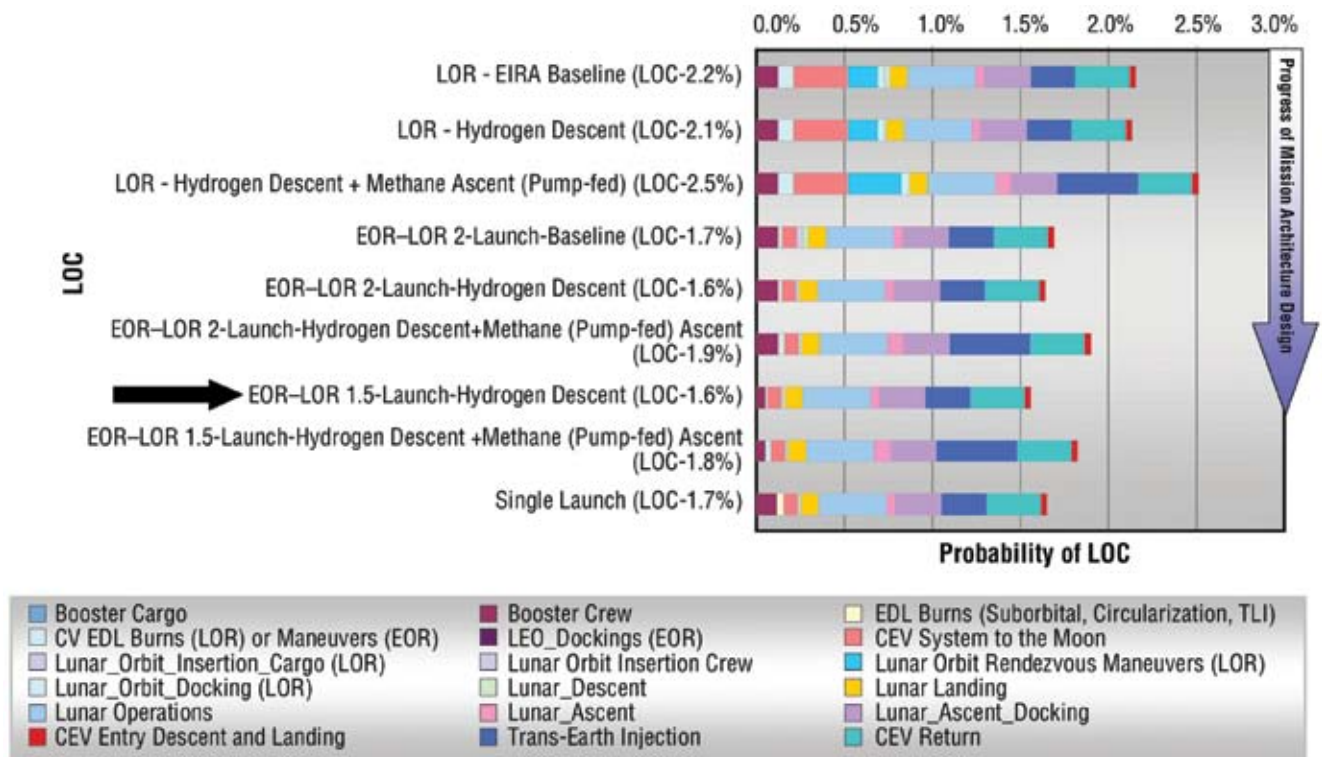

Figure 1-13. LOC Comparison

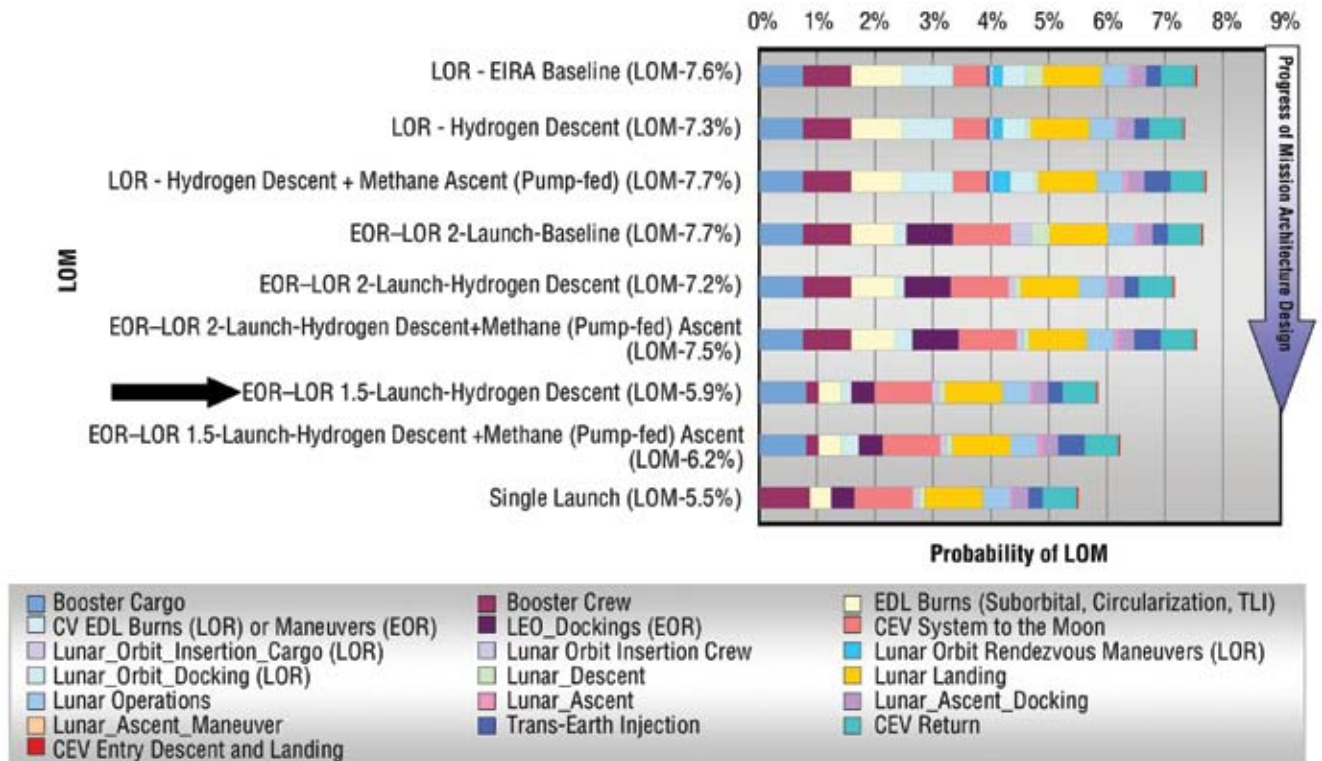

Figure 1-14. LOM Comparison

P(LOC) was dominated by propulsive events and vehicle operating lifetimes. As shown in **Figure 1-13**, LVs varied only slightly between the 2-launch (crew launched on a heavy-lift booster) and 1.5-launch (crew launched on a single Solid Rocket Booster (SRB) CLV) options. The LOR options had added risk due to the lander being sent to the lunar orbit separately from the CEV, and thus not having a backup crew volume during transit to handle “Apollo 13”-like contingencies. The LOR mission also required the CEV SM to perform an LOI maneuver. Generally, each time a pump-fed engine technology was introduced to replace a pressure-fed system, risk increased, although the LOX/hydrogen engine modeled for the lander descent stage had a high degree of heritage from existing RL-10 engine technology.

When all the mission event probabilities were summed, all mission options fell within a relatively narrow range (1.6 to 2.5 percent), but the difference between the highest- and lowest-risk options approached a factor of two. Missions using the LOR mission mode were the highest risk options, while EOR-LOR “1.5-launch” options were the lowest. Missions that utilized a higher-performing LOX/hydrogen lander descent stage scored approximately the same as the baseline option that used pressure-fed LOX/methane, but a change to a pump-fed LOX/methane ascent stage resulted in an appreciable increase in risk. The lowest P(LOC) option was the 1.5-launch EOR-LOR mission using a pump-fed LOX/hydrogen lander descent stage and pressure-fed LOX/methane engines for both the lander ascent stage and CEV SM.

P(LOM) generally followed the same trends as P(LOC). **Figure 1-14** illustrates the reliability benefits of launching crew on the single-SRB CLV, the reduced risk of having a single EDS, and the penalties associated with pump-fed engines. LOR and EOR-LOR 2-launch options exhibited the greatest P(LOM), in a range between 7 and 8 percent per mission. The substitution of a LOX/hydrogen lander descent stage engine actually increased mission reliability by adding engine-out performance to the LOI and lunar landing phases of the mission, but further pushing LOX/methane engine technology toward a pump-fed system lowered reliability by eliminating commonality with the CEV SM engine and adding complexity.

The single-launch mission option scored the highest reliability overall, owing mainly to it requiring only a single launch. Of the missions that provide the full lunar landing site access and return capabilities, EOR-LOR 1.5-launch modes were nearly equal to the single-launch option. Specifically, the EOR-LOR 1.5-launch option using the LOX/hydrogen lander descent stage engines scored the lowest P(LOM) among the full-up mission options. Interestingly, this same mission mode and propulsion technology combination scored the lowest P(LOC) as well.

1.3.2.3.2 Mission Mode Cost Comparison

Figure 1-15 summarizes the Life Cycle Cost (LCC) analysis results. To enable a fair comparison among the options, the complete LCC, including Design, Development, Test, and Evaluation (DDT&E), flight units, operations, technology development, robotic precursors, and facilities, were all included in this analysis. Generally, the choice of mission mode had only a small effect on the LCC of the exploration program. Of the options modeled, the 1.5-launch EOR–LOR mission using a LOX/hydrogen lander descent stage propulsion system exhibited an LCC that was in the same range as the other options.

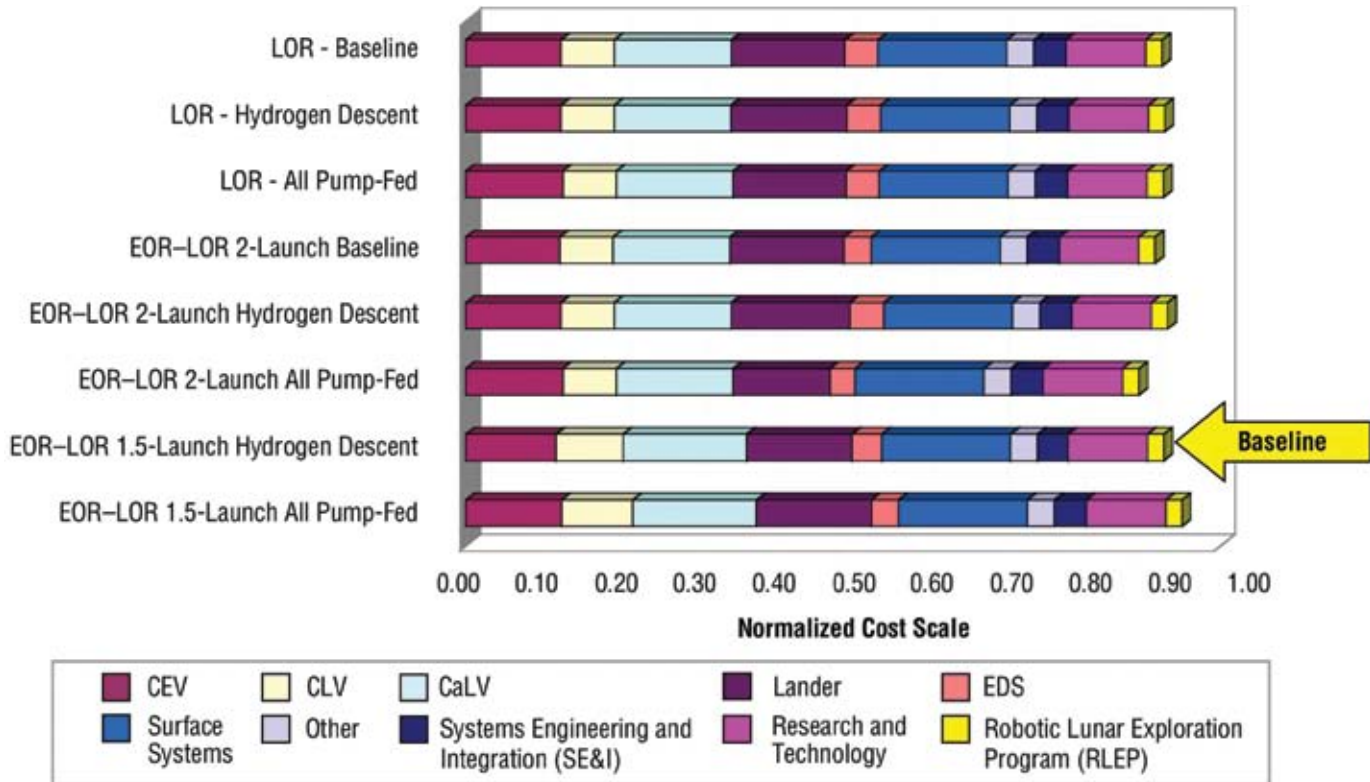

Figure 1-15. Mission Mode LCC Through 2025

Of the full-performance options studied, the 1.5-launch EOR–LOR mode yielded both the lowest P(LOM) and the lowest P(LOC) when flown with a LOX/hydrogen lander descent stage and common pressure-fed LOX/methane propulsion system for both the lander ascent stage and CEV SM. Cost analysis was less definitive, but also showed this same EOR–LOR 1.5-launch option being among the lowest cost of all the alternatives studied. Based on the convergence of robust technical performance, low P(LOC), low P(LOM), and low LCC, the 1.5-launch EOR–LOR option using LOX/hydrogen lander descent stage propulsion was selected as the mission mode to return crews to the Moon.

1.3.3 LSAM Reference Design

The ESAS team examined the unique architecture of the lunar lander, or LSAM. Other architecture element designs and trade studies were also accomplished by the team. The reference LSAM concept, shown in **Figure 1-16**, for the ESAS 1.5-launch EOR–LOR architecture is a two-stage, single-cabin lander similar in form and function to the Apollo LM.

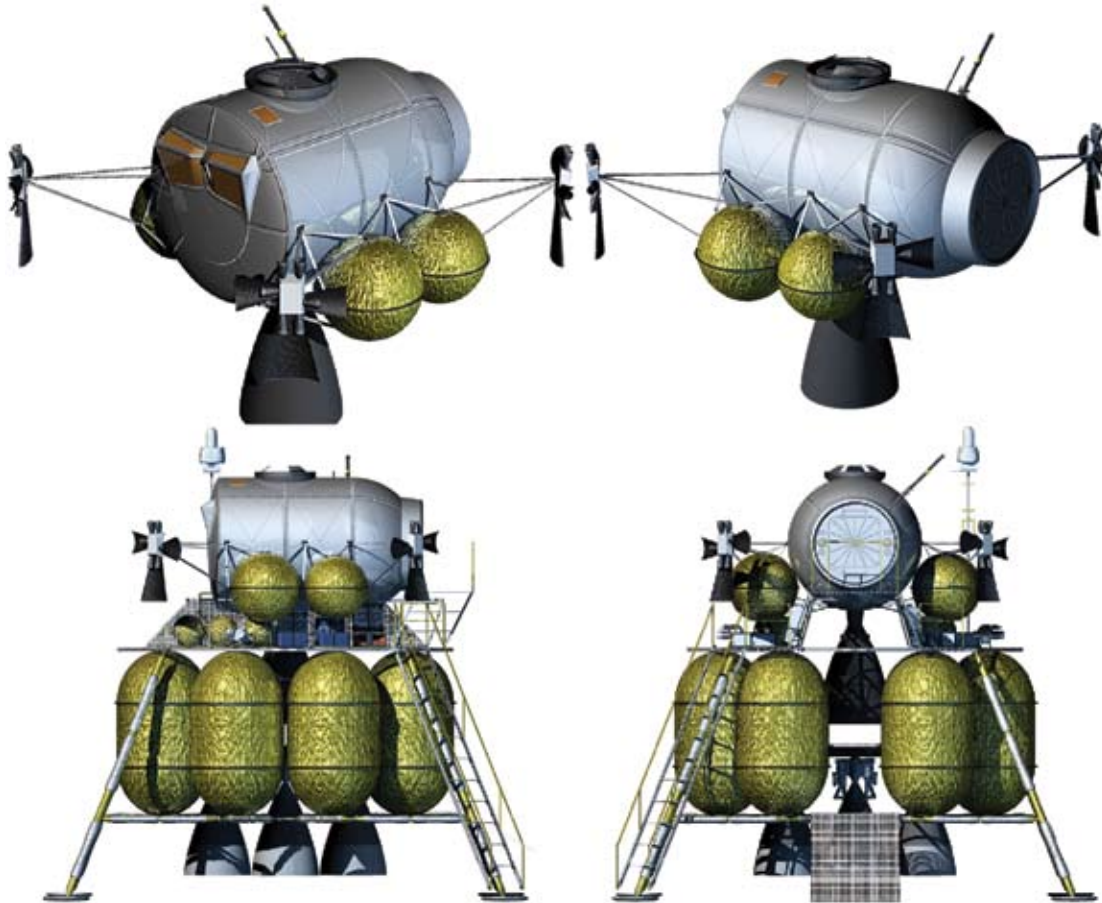

Figure 1-16. LSAM Configuration

The LSAM ascent stage, in conjunction with the descent stage, is capable of supporting four crew members for 7 days on the lunar surface and transporting the crew from the surface to lunar orbit. The ascent stage utilizes an integrated pressure-fed LOX/methane propulsion system, similar to the CEV SM, to perform coplanar ascent to a 100-km circular lunar orbit, rendezvous and docking with the CEV, and self-disposal following separation from the CEV. A single 44.5-kN (10,000-lbf) ascent propulsion system engine and sixteen 445-N (100-lbf) Reaction Control System (RCS) thrusters are used for vehicle maneuvering and attitude control. Spherical ascent stage propellant tanks are sized to perform up to 1,866 m/s of main engine and 22 m/s of RCS delta-V.

The LSAM pressure vessel is a horizontal short cylinder 3.0 m in diameter and 5.0 m long to provide 31.8 m³ of pressurized volume for the crew during lunar operations. A nominal internal atmospheric pressure for the ascent stage of 65.5 kPa (9.5 psia) with a 30 percent oxygen composition has been assumed. The LSAM's EVA strategy while on the lunar surface is daily

EVA with all four crew members egressing the vehicle simultaneously. For missions lasting beyond 4 days, a rest day between EVAs may be required. Unlike the Apollo LM, the LSAM ascent stage crew cabin includes a bulkhead to partition a section of the pressurized volume, which can serve as an internal airlock. Thus, crew members don their surface EVA suits in the airlock, depressurize the airlock, and egress the vehicle. Ascent stage power generation capabilities include rechargeable batteries for the 3 hours from liftoff to docking with the CEV. Power generation for all other LSAM operations prior to liftoff is provided by the descent stage.

The LSAM descent stage is used in crewed lunar exploration missions to insert the CEV into LLO, land the ascent stage and cargo on the surface, and provide the vehicle's life support and power generation capabilities during an assumed 7-day lunar surface stay. The descent stage uses a pump-fed LOX/hydrogen descent propulsion system to perform LOI and coplanar descent from a 100-km circular lunar orbit. Four 66.7-kN (15,000-lbf) descent propulsion system derived from the RL-10 engine family are used for vehicle maneuvering, while the ascent stage RCS is used for combined-vehicle attitude control. The descent propulsion system engines are arranged symmetrically around the vehicle centerline at the base of the descent stage.

Six cylindrical hydrogen and two cylindrical oxygen descent stage tanks are included on the LSAM to store the propellant needed to perform up to 1,100 m/s of LOI delta-V with the CEV and ascent stage attached, and 1,900 m/s of descent delta-V with only the ascent stage attached. The eight LSAM propellant tanks are mounted around the descent stage in a ring arrangement, leaving two open bays on opposite sides of the stage exterior for surface access and cargo stowage, and a circular opening along the vehicle centerline for housing the single ascent stage engine nozzle. In addition to supporting its own propulsion system, the descent stage structure also serves as a support system and launch platform for the ascent stage, provides attachment for a four-leg landing gear system, provides for crew access to the surface, and serves as the attachment point to the EDS.

Three Proton Exchange Membrane (PEM) fuel cells on the descent stage provide LSAM power generation from Earth launch to lunar ascent. Oxygen reactant for the fuel cells is stored in the oxygen propellant tanks, while hydrogen reactant is stored in the hydrogen propellant tanks. The descent stage also contains the gaseous nitrogen, potable water, and water storage systems needed for the mission up to lunar ascent. These systems were included on the descent stage rather than the ascent stage to avoid the penalty of lifting unnecessary mass back to lunar orbit. Finally, the descent stage provides the mounting location for the Active Thermal Control System (ATCS) radiators. LSAM heat rejection following liftoff from the lunar surface is accomplished using a fluid evaporator system.

1.3.4 Lunar Architecture Recommendations

The lunar architecture defined by the ESAS integrates mission mode analysis, flight element functionality, and the activities to be performed on the lunar surface. An integrated analysis of mission performance, safety, reliability, and cost led to the selection of a preferred mission mode, the definition of functional and performance requirements for the vehicle set, and the definition of lunar surface operations. Additionally, the analysis looked back to examine how the CEV and CLV would be used to transport crew and cargo to the ISS, and forward to define the systems that will carry explorers to Mars and beyond, in order to identify evolutionary functional, technological, and operational threads that bind these destinations together.

1.3.4.1 Mission Mode

The ESAS team recommends a combination of EOR–LOR as the preferred lunar mission mode. The mission mode is the fundamental lunar architecture decision that defines where space flight elements come together and what functions each of these elements perform. The EOR–LOR mode is executed with a combination of the launch of separate crew and cargo vehicles, and by utilizing separate CEV and lander vehicles that rendezvous in lunar orbit. This mission mode combined superior performance with low LCC and high crew safety and mission reliability.

The lunar mission mode study initially considered a wide variety of locations of transportation “nodes” in both cislunar space and the vicinity of Earth. Initial analyses eliminated libration point staging and direct return mission options, leaving the mission mode analysis to investigate a matrix of low-lunar (LOR) and Earth-orbital (EOR) staging nodes.

1.3.4.2 Mission Sequence

The ESAS team recommends a mission sequence that uses a single launch of the CaLV to place the lunar lander and EDS in Earth orbit. The launch of a CLV will follow and place the CEV and crew in Earth orbit, where the CEV and lander/EDS will rendezvous. The combination of the large cargo launch and the CLV is termed a “1.5-launch EOR–LOR” mission. Following rendezvous and checkout in LEO, the EDS will then inject the stack on a trans-lunar trajectory and be expended. The lander and CEV are captured into lunar orbit by the descent stage of the two-stage lander, and all four crew members transfer to the lander and descend to the surface, leaving the CEV operating autonomously in orbit. The lander features an airlock and the capability to support up to a 7-day surface sortie. Following the lunar surface mission, the lander’s ascent stage returns the crew to lunar orbit and docks with the orbiting CEV. The crew transfers back to the CEV and departs the Moon using the CEV SM propulsion system. The CEV then performs a direct-Earth-entry and parachutes to a land landing on the west coast of the United States.

1.3.4.3 Lunar Surface Activities

Recommended lunar surface activities consist of a balance of lunar science, resource utilization, and “Mars-forward” technology and operational demonstrations. The architecture will initially enable sortie-class missions of up to 7 days duration with the entire crew of four residing in and performing EVAs from the lunar lander.

The ESAS team recommends the deployment of a lunar outpost using the “incremental build” approach. Along with the crew, the lander can deliver 500 kg of payload to the surface, and up to 2,200 kg of additional payload if the maximum landed capacity is utilized. This capability opens the possibility of deploying an outpost incrementally by accumulating components delivered by sortie missions to a common location. This approach is more demanding than one that delivers larger cargo elements. In particular, the habitat, power system, pressurized rovers, and some resource utilization equipment will be challenging to divide and deploy in component pieces. The alternative to this incremental approach is to develop a dedicated cargo lander that can deliver large payloads of up to 21 mT.

The study team defined high-priority landing sites that were used to establish sortie mission performance. Of those sites, a south polar location was chosen as a reference outpost site in order to further investigate the operations at a permanent outpost. A photovoltaic power system was chosen as the baseline power system for the outpost.

1.3.4.4 Propulsion Choices and Delta-V Assignment

The ESAS team examined a wide variety of propulsion system types and potential delta-V allocations for each architecture element. It is recommended that the CaLV's upper stage will serve as the EDS for lunar missions and will perform the TLI propulsive maneuver. The descent stage of the lunar lander was selected to perform LOI and up to 200 m/s of plane change using LOX/hydrogen propulsion. The lunar lander descent stage will perform a coplanar descent to the surface using the same engine that performed LOI, and the crew will perform the surface mission while the CEV orbits autonomously. The lunar lander ascent stage will perform a coplanar ascent using LOX/methane propulsion that is common with the CEV SM propulsion system. The SM will perform up to a 90-deg plane change and TEI with full co-azimuth control (1,450 m/s total delta-V).

Pump-fed LOX/hydrogen propulsion was selected for the lunar descent stage because of the great performance, cost, and risk leverage that was found when the lunar lander descent stage propulsion efficiency was increased by the use of a LOX/hydrogen system. To achieve a high-reliability lunar ascent propulsion system, and to establish the linkage to in-situ propellant use, common pressure-fed LOX/methane engines were chosen for the CEV SM and lunar ascent stage propulsion systems.

1.3.4.5 Global Access

It is recommended that the lunar architecture preserve the option for full global landing site access for sortie or outpost missions. Landing at any site on the Moon sizes the magnitude of the LOI maneuver. A nominal 900-m/s LOI burn enables access to the equator and poles, and a maximum of 1,313 m/s is required for immediate access to any site on the lunar globe. The architecture uses a combination of orbital loiter and delta-V to access any landing in order to balance additional propulsive requirements on the lander descent stage and additional orbital lifetime of the CEV systems. The lander descent stage was sized for a 900-m/s LOI plus a 200-m/s maximum nodal plane change, for a total of 1,100 m/s in addition to lunar descent propulsion. This value allows the crew to immediately access 84 percent of the lunar surface and to have full global access with no more than 3 days loiter in lunar orbit.

1.3.4.6 Anytime Return

It is recommended that the architecture provide the capability to return to Earth in 5 days or less for sortie missions at any site on the lunar globe. The requirement to return anytime from the surface of the Moon to Earth was the design driver of the SM propulsion system. The lunar mission requires a total of 1,450 m/s of delta-V, combining a 900-m/s TEI maneuver, a worst-case 90-deg nodal plane change, and Earth entry azimuth control. This capability enables "anytime return" if the lander is able to perform a coplanar ascent to the CEV. For sortie duration missions of 7 days or less, the CEV's orbital inclination and node will be chosen to enable a coplanar ascent. Outpost missions will also have "anytime return" capability if the outpost is located at a polar or equatorial site. For other sites, loitering on the surface at the outpost may be required to enable ascent to the orbiting CEV.

1.3.4.7 Lunar Lander

The recommended lunar lander provides the capability to capture itself and the CEV into lunar orbit, to perform a plane change prior to descent, and to descend to the lunar surface with all four crew members using a throttleable LOX/hydrogen propulsion system. On the lunar surface, the lander serves as the crew's habitat for the duration of the surface stay and provides full airlock capability for EVA. Additionally, the lander carries a nominal payload of 500 kg and has the capability to deliver an additional 2,200 kg to the lunar surface. The lander's ascent stage uses LOX/methane propulsion to carry the crew back into lunar orbit to rendezvous with the waiting CEV. The lander's propulsion system is chosen to make it compatible with ISRU-produced propellants and common with the CEV SM propulsion system.

1.3.4.8 ISS-Moon-Mars Connections

Evolutionary paths were established within the architecture to link near-term ISS crew and cargo delivery missions, human missions to the lunar surface, and farther-term human missions to Mars and beyond. The key paths that enable the architecture to evolve over time are the design of the CEV, the choice of CLV and CaLV, the selection of technologies (particularly propulsion technologies), and the operational procedures and systems that extend across the destinations. The CEV is sized to accommodate crew sizes up to the Mars complement of six. The CLV was chosen to be a reliable crew launch system that would be the starting point of a crew's journey to the ISS, Moon, or Mars; and the CaLV was chosen, in part, to deliver 100-mT-class human Mars mission payloads to LEO. Propulsion choices were made to link propulsive elements for the purpose of risk reduction, and to enable the use of future ISRU-produced propellants. These propellant choices are further linked to the ISRU technology experiments to be performed on the planetary surfaces. Finally, EVA systems and mission operations will be developed to share common attributes across all ISS, lunar, and Mars destinations.

1.4 Crew Exploration Vehicle (CEV)

1.4.1 Overview

One of the key requirements to enable a successful human space exploration program is the development and implementation of a vehicle capable of transporting and housing crew on LEO, lunar, and Mars missions. A major portion of the ESAS effort focused on the design and development of the CEV, the means by which NASA plans to accomplish these mission objectives. The CEV reference design includes a pressurized CM to support the Earth launch and return of a crew of up to six, a Launch Abort System (LAS), and an unpressurized SM to provide propulsion, power, and other supporting capabilities to meet the CEV's in-space mission needs.

In response to the ESAS charter, the first crewed flight of the CEV system to the ISS was assumed to occur in 2011. The CEV design requirements were, however, to be focused on exploration needs beyond LEO. Therefore, the team started with the existing ESMD Revision E Crew Transportation System (CTS) requirements and assessed these against ISS needs for areas of concern where CEV may fall short of ISS expectations. Any such shortcomings were then examined on a case-by-case basis to determine whether they were critical to performing the ISS support function. If they were found not to be critical, such shortcomings were considered as guidelines and not requirements on the CEV.

While the CEV design was sized for lunar missions carrying a crew of four, the vehicle was designed to also be reconfigurable to accommodate up to six crew for ISS and future Mars mission scenarios. The CEV can transfer and return crew and cargo to the ISS and stay for 6 months in a quiescent state. The lunar CEV design has direct applications to ISS missions without significant changes in the vehicle design. The lunar and ISS configurations share the same SM, but the ISS mission has much lower delta-V requirements. Hence, the SM propellant tanks can be loaded with additional propellant for ISS missions to provide benefits in launch aborts, on-orbit phasing, and ISS re-boost. Other vehicle block derivatives can deliver pressurized and unpressurized cargo to the ISS.

Vehicle size, layout, and mass were of central importance in this study, as each factors into vital aspects of mission planning considerations. Detailed subsystem definitions were developed and vehicle layouts were completed for a four-crew-member lunar DRM and a six-crew-member Mars DRM. The lunar mission was a design driver because it had the most active days with the crew inside. The Mars DRM, which was a short duration mission of only 1 to 2 days to and from an orbiting MTV, drove the design to accommodate a crew of six. Ultimately, the CEV CM was sized to be configurable for accommodating six crew members even for an early mission to the ISS.

Additional details on the CEV trade studies and analysis results are contained in **Section 5, Crew Exploration Vehicle**, of this report.

1.4.2 CEV Modular Design Approach

The different CEV configurations were each assigned a block number to distinguish their unique functionality. The Block 1 vehicles support the ISS with transfer of crew and cargo. The Block 1A vehicle transfers crew to and from the ISS. This vehicle can stay at the ISS for 6 months. Varying complements of crew and pressurized cargo can be transported in the Block 1A CM. The Block 1B CM transports pressurized cargo to and from the ISS. The crew accommodations are removed and replaced with a secondary structure to support the cargo complement. The relationship between the Block 1A and Block 1B CMs is similar to that of the Russian Soyuz and Progress vehicles. Unpressurized cargo can be transported to the ISS via the CDV. The CDV replaces the CM with a structural “strong back” that supports the cargo being transferred. The CDV uses the same SM as the other blocks and also requires a suite of avionics to perform this mission. The CDV is expended after its delivery mission. The Block 2 CEV is the reference platform sized to transfer crew to the lunar vicinity and back. Detailed sizing was performed for this configuration and the other blocks were derived from its design. The Block 3 configuration is envisioned as a crewed transfer vehicle to and from an MTV in Earth orbit. The crew complement for this configuration is six. No detailed design requirements were established for this block and detailed mass estimates were never derived.

Design details for each block configuration are discussed in **Section 5, Crew Exploration Vehicle**. A mass summary for each block is shown in **Figure 1-17**. Detailed mass statements were derived for each block and are provided in **Appendix 5A, CEV Detailed Mass Breakdowns**.

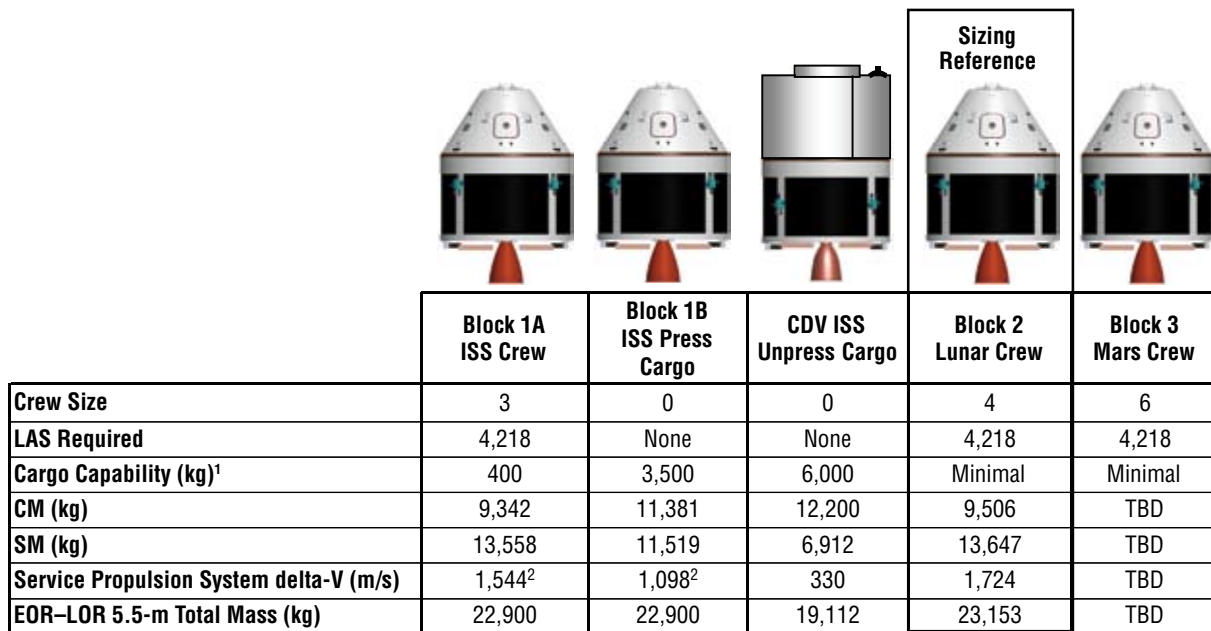

Note 1: Cargo capability is the total cargo capability of the vehicle including Flight Support Equipment (FSE) and support structure.

Note 2: A packaging factor of 1.29 was assumed for the pressurized cargo and 2.0 for unpressurized cargo.

Extra Block 1A and 1B service propulsion system delta-V used for late ascent abort coverage.

Figure 1-17. Block Mass Summaries

1.4.2.1 Block 2 Lunar CEV

The lunar CEV CM, in conjunction with the SM and LV/EDS, is used to transport four crew members from Earth to lunar orbit and return them to Earth. The CM provides habitable volume for the crew, life support, docking and pressurized crew transfer to the LSAM, and atmospheric entry and landing capabilities. Upon return, a combination of parachutes and airbags provide for a nominal land touchdown with water flotation systems included for water landings following an aborted mission. Three main parachutes slow the CEV CM to a steady-state sink rate of 7.3 m/s (24 ft/s), and, prior to touchdown, the ablative aft heat shield is jettisoned and four Kevlar airbags are deployed for soft landing. After recovery, the CEV is refurbished and reflown with a lifetime up to 10 missions.

A scaled Apollo Command Module shape with a base diameter of 5.5 m and sidewall angle of 32.5 deg was selected for the OML of the CEV CM. This configuration provides 29.4 m³ of pressurized volume and 12 to 15 m³ of habitable volume for the crew during transits between Earth and the Moon. The CEV CM operates at a nominal internal pressure of 65.5 kPa (9.5 psia) with 30 percent oxygen composition for lunar missions, although the pressure vessel structure is designed for a maximum pressure of 101.3 kPa (14.7 psia). Operating at this higher pressure allows the CEV to transport crew to the ISS without the use of an intermediate airlock. For the lunar missions, the CM launches with a sea-level atmospheric pressure (101.3 kPa), and the cabin is depressurized to 65.5 kPa prior to docking with the LSAM.

The lunar CEV CM propulsion system provides vehicle attitude control for atmospheric entry following separation from the SM and range error corrections during the exoatmospheric portion of a lunar skip-entry return trajectory. A gaseous oxygen/ethanol bipropellant system is assumed with a total delta-V of 50 m/s.

Illustrations of the reference lunar CEV CM are shown in **Figure 1-18**.

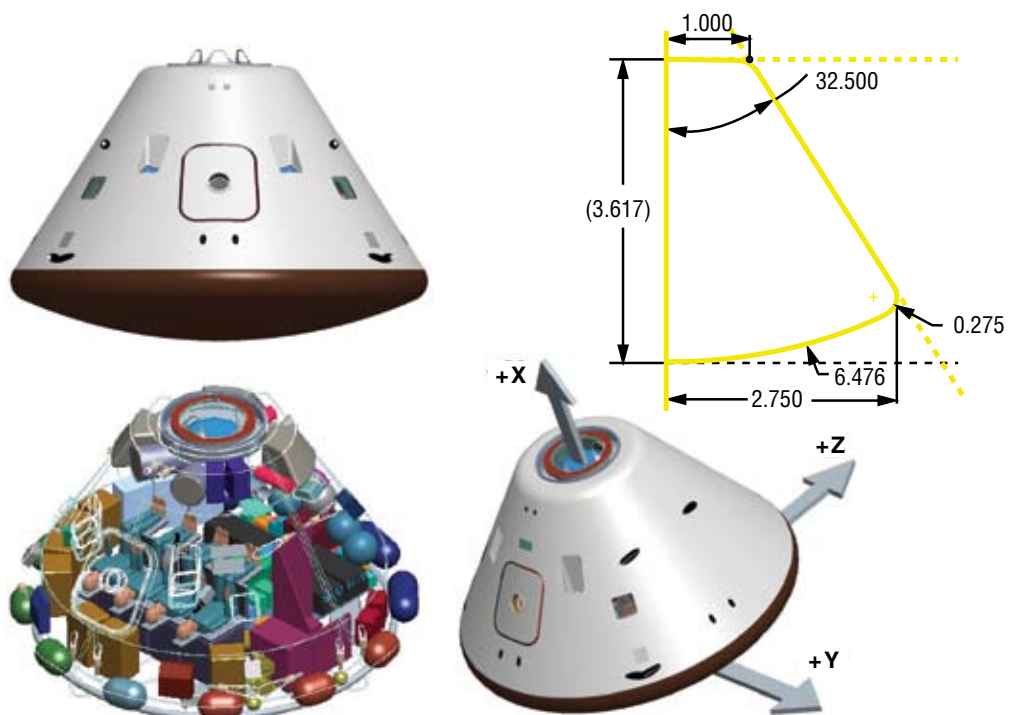

Figure 1-18. Reference Lunar CEV CM

1.4.2.2 Block 2 Lunar CEV SM

The lunar CEV SM is included in the ESAS exploration architecture to provide major translational maneuvering capability, power generation, and heat rejection for the CEV CM. The SM assumes an integrated pressure-fed oxygen/methane service propulsion system and RCS to perform rendezvous and docking with the LSAM in Earth orbit, any contingency plane changes needed prior to lunar ascent, TEI, and self-disposal following separation from the CM. One 66.7-kN (15,000-lbf) service propulsion system and twenty-four 445-N (100-lbf) RCS thrusters, engines common to both the SM and the LSAM ascent stage, are used for on-orbit maneuvering. The SM propellant tanks are sized to perform up to 1,724 m/s of service propulsion system and 50 m/s of RCS delta-V with the CEV CM attached and 15 m/s of RCS delta-V after separation. In the event of a late ascent abort off the CLV, the SM service propulsion system may also be used for separating from the LV and either aborting to near-coastline water landings or aborting to orbit.

Two deployable, single-axis gimbaling solar arrays are also included to generate the necessary CEV power from Earth-Orbit Insertion (EOI) to CM–SM separation prior to entry. For long-duration outpost missions to the lunar surface, lasting up to 180 days, the CEV remains unoccupied in lunar orbit. Solar arrays were selected instead of fuel cells or other similar power generation options because the reactant mass requirements associated with providing keep-alive power during the long dormant period for fuel cells became significantly higher than the mass of a nonconsumable system such as solar arrays. The solar arrays use state-of-the-art, three-junction, photovoltaic cells. Finally, the SM composite primary structure also provides a mounting location for four radiator panels. These panels provide heat rejection capability for the CEV fluid loop heat acquisition system.

Illustrations of the reference lunar CEV SM are shown in **Figure 1-19**.

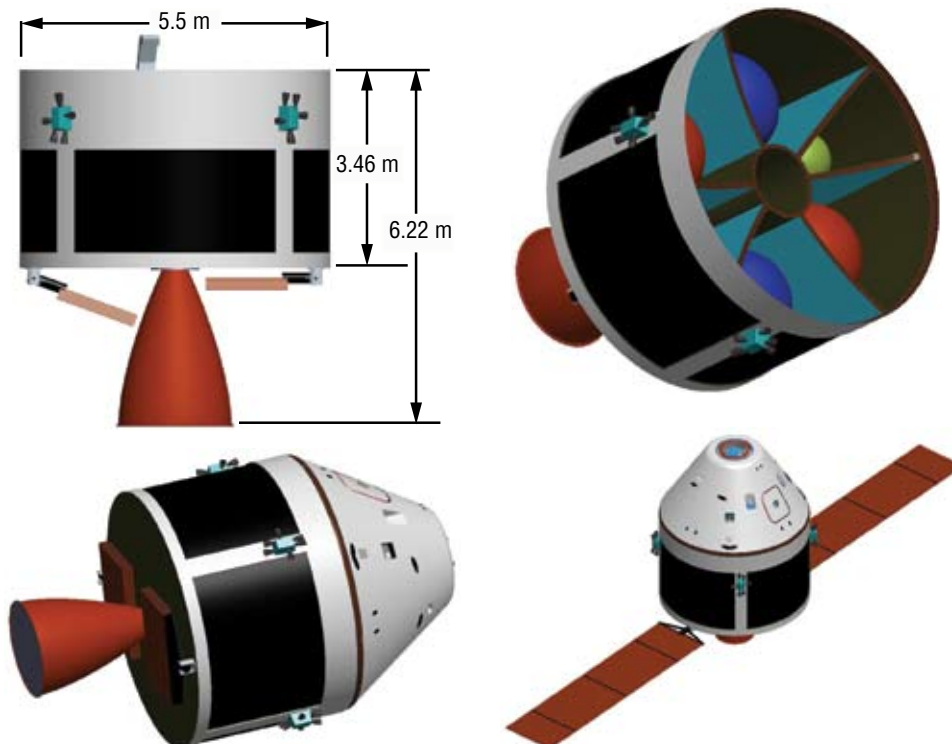

Figure 1-19. Reference Lunar CEV SM

1.4.2.3 Block 2 LAS

The LAS was sized to pull the CEV CM away from a thrusting LV at 10 g's acceleration. The LAS sizing concept is similar to the Apollo Launch Escape System (LES) in that it is a tractor system that is mounted ahead of the CM. The main difference is that the exhaust nozzles are located near the top of the motor, which will reduce the impingement loads on the CM.

The LAS features an active trajectory control system based on solid propellant, a solid rocket escape motor, forward recessed exhaust nozzles, and a CM adaptor. The motor measures 76 cm in diameter and 5.5 m in length, while eight canted thrusters aid in eliminating plume impingement on the CM. A star fuel grain minimizes motor size and redundant igniters are intended to guarantee the system's start.

The LAS provides abort from the launch pad and throughout powered flight of the booster first stage. The LAS is jettisoned approximately 20 to 30 sec after second-stage ignition. Further analyses are required to determine the optimum point in the trajectory for LAS jettison. After the LAS is jettisoned, launch aborts for the crew are provided by the SM propulsion system.

The mass for a 10-g LAS for a 21.4-mT CM is 4.2 mT. **Figure 1-20** depicts the LAS on top of the CM.



Figure 1-20. CEV with LAS

1.4.2.4 Block 1A ISS CEV CM and SM

The ISS CEV CM in the ESAS architecture is the Block 1 variant of the lunar CM designed to rotate three to six crew members and cargo to the ISS. The ISS CM is designed largely to support lunar exploration requirements, with a minimal set of modifications made to support ISS crew rotation. Initial mass for the three-crew ISS CM variant is 162 kg less than the lunar CM mass.

The ISS SM is identical to the SM designed for lunar exploration, except that propellant is off-loaded to reflect the lower delta-V requirements of ISS crew rotation compared to LOR. Propellant requirements for the ISS SM are estimated based on using the largest vehicle the SM may deliver to the ISS and subsequently deorbit, which is currently the unpressurized CDV. Other potential ISS payloads for the SM are the crewed CEV CM and pressurized cargo CEV; however, these have total masses less than the unpressurized CDV. The CDV has a total mass of 12,200 kg, compared to 9,342 kg for the three-crew CEV, 9,551 kg for the six-crew CEV, and 11,381 kg for the pressurized cargo delivery CEV.

1.4.2.5 Block 1B ISS Pressurized Cargo CM Variant

The ESAS architecture also includes a variant of the ISS CEV CM that may be used to deliver several tons of pressurized cargo to the ISS without crew on board and return an equivalent mass of cargo to a safe Earth landing. This spacecraft is nearly identical to the ISS crew rotation variant, with the exception that the personnel and most components associated with providing crew accommodations are removed and replaced with cargo. Initial mass for the uncrewed ISS CM variant is 2,039 kg greater than the three-crew ISS crew rotation CM.

1.4.2.6 ISS Unpressurized CDV

The ISS CDV was sized to deliver unpressurized cargo to the ISS. The CDV is mainly a structural “strong back” with a CBM for attachment to the ISS. The CDV utilizes the same SM as the other block configurations for transfer from the LV injection orbit to the ISS. Because the avionics for the other CEV variants are located within the CM, an avionics pallet is required for the CDV. This pallet would support the avionics and provide the connection to the ATCS on the SM.

The CDV was sized to transport two 1,500-kg unpressurized ORUs for the ISS. Examples of ORUs include Control Moment Gyroscopes (CMGs) and pump packages. The packaging factor for these ORUs was assumed to be 100 percent; therefore, the trays and secondary support structure for the cargo is estimated to be 3,000 kg, for a total cargo complement of 6,000 kg. The total estimate for the CDV without the SM is 12,200 kg.

Operationally, the CDV would perform automated rendezvous and proximity operations with the ISS and would then be grappled by the SSRMS and berthed to an available port. Two releasable cargo pallets are used to provide structural attachment for the ORUs. The cargo pallets can be grappled by the SSRMS and relocated to the ISS truss as required. Once the cargo has been relocated on the ISS, the CDV would depart from the ISS and perform an automated deorbit burn for burnup and disposal in the ocean.

Illustrations of the reference CDV are shown in **Figures 1-21** and **1-22**.

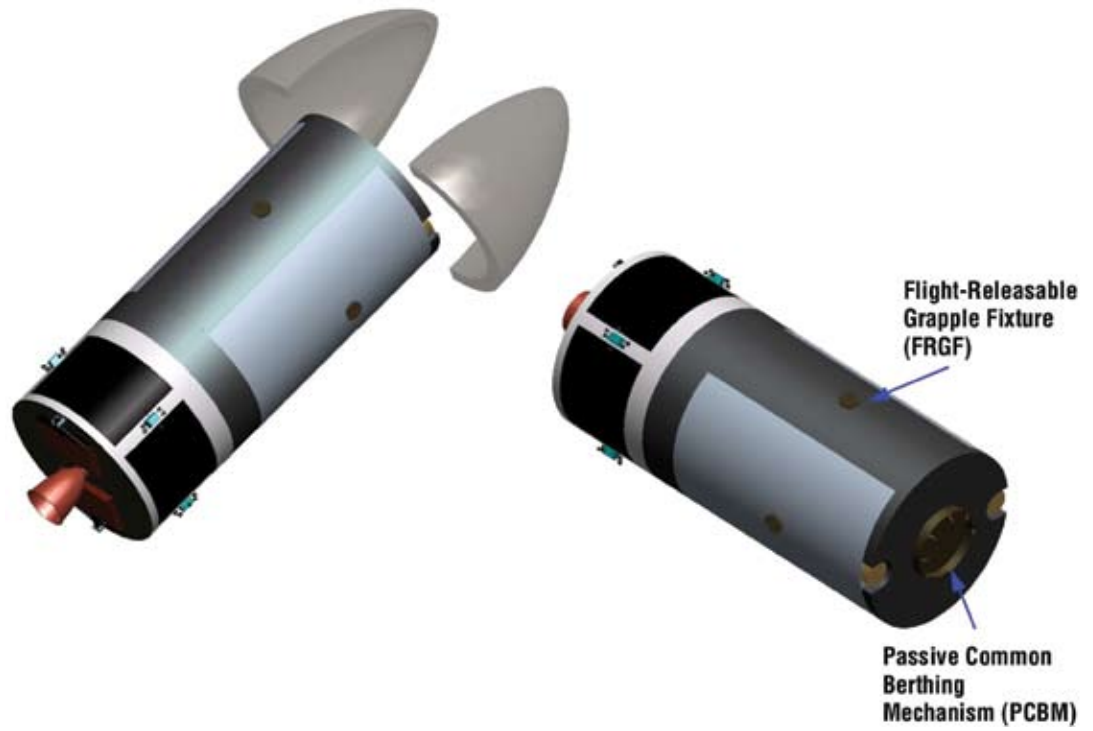

Figure 1-21. CDV

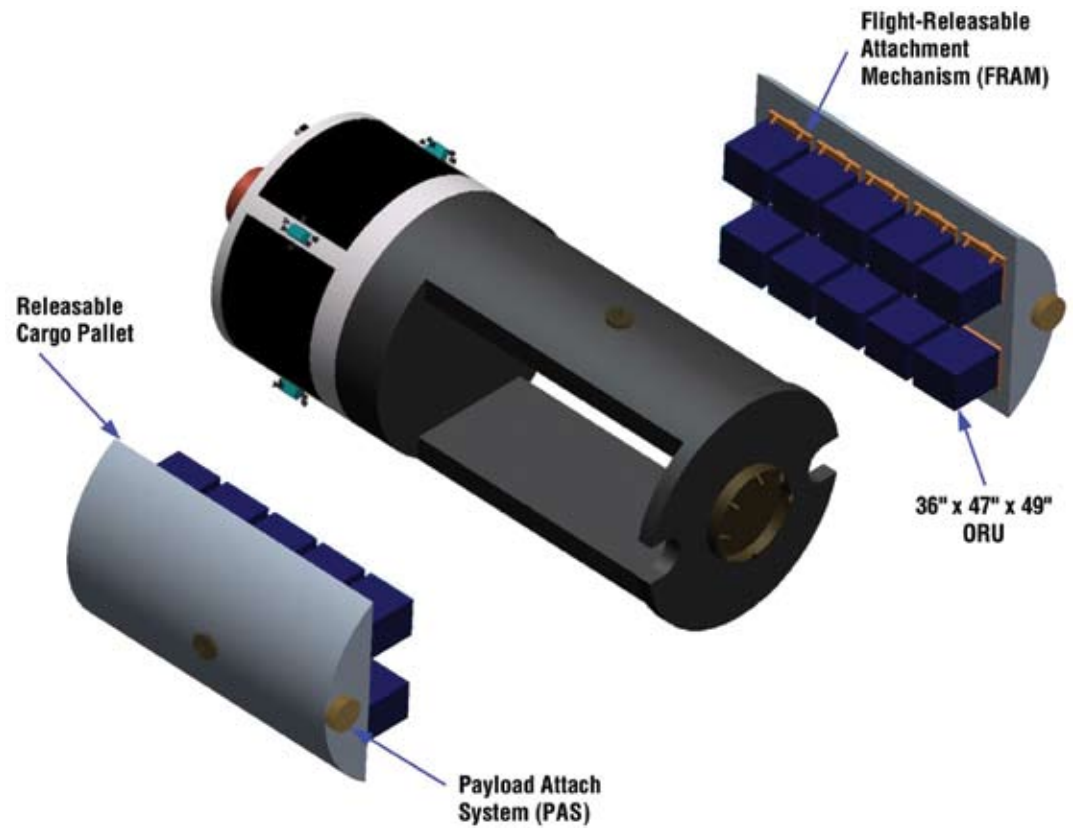

Figure 1-22. CDV Cargo Pallets

1.4.2.7 Block 3 Mars CEV Variant

The ESAS reference Mars mission utilizes a Block 3 CEV to transfer a crew of six between Earth and an MTV at the beginning and end of the Mars exploration mission. A Block 3 CEV CM and SM is launched by the CLV into an orbit matching the inclination of the awaiting MTV. The CEV is first injected into a 55- x 296-km altitude orbit while the MTV loiters in a circular orbit of 800- to 1,200-km altitude. It then takes the CEV up to 2 days to perform orbit-raising maneuvers to close on the MTV, conducting a standard ISS-type rendezvous and docking approach to the MTV. After docking, the CEV crew performs a leak check, equalizes pressure with the MTV, and opens hatches. Once crew and cargo transfer activities are complete, the CEV is configured to a quiescent state and remains docked to the MTV for the trip to Mars and back. Periodic systems health checks and monitoring are performed by the ground and flight crew throughout the mission.

As the MTV approaches Earth upon completion of the 1.5- to 2.5-year round-trip mission, the crew performs a pre-undock health check of all entry critical systems, transfers to the CEV, closes hatches, performs leak checks, and undocks from the MTV. The CEV departs 24 to 48 hours prior to Earth entry, and the MTV then either performs a diversion maneuver to fly by Earth or recaptures into Earth orbit. After undocking, the CEV conducts an onboard-targeted, ground-validated burn to target for the proper entry corridor, and, as entry approaches, the CEV CM maneuvers to the proper Entry Interface (EI) attitude for a direct-guided entry to the landing site. Earth entry speeds from a nominal Mars return trajectory may be as high as 14 km/s, compared to 11 km/s for the Block 2 CEV. The CEV performs a nominal landing at the primary land-based landing site and the crew and vehicle are recovered.

Figure 1-23 shows the Block 3 CEV CM configured to carry six crew members to the MTV.



Figure 1-23. Block 3 CEV CM

1.4.3 CEV Design Evolution

The design and shape of the CEV CM evolved in four design cycles throughout the study, beginning with an Apollo-derivative configuration 5 m in diameter and a sidewall angle of 30 deg. This configuration provided an OML volume of 36.5 m³ and a pressurized volume of 22.3 m³. The CM also included 5 g/cm² of supplemental radiation protection on the cabin walls for the crew's protection. Layouts for a crew of six and the associated equipment and stowage were very constrained and left very little habitable volume for the crew.

A larger CEV was considered in Cycle 2 which grew the outer diameter to 5.5 m and reduced the sidewall angles to 25 deg. Both of these changes substantially increased the internal volume. The pressurized volume increased by 75 percent to 39.0 m³ and the net habitable volume increased by over 50 percent to 19.4 m³. The desire in this design cycle was to provide enough interior volume for the crew to be able to stand up in and don/doff lunar EVA suits for the surface direct mission. Most of the system design parameters stayed the same for this cycle including the 5 g/cm² of supplemental radiation protection.

Cycle 3 reduced the sidewall angles even further to 20 deg in an effort to achieve monostability on Earth entry. The sidewall angle increased the volume further. Because the increases in volume were also increasing the vehicle mass, the height of the vehicle was reduced by 17 inches, reducing the height-to-width aspect ratio. This configuration showed the most promise in the quest for monostability, but the proper Center of Gravity (CG) was still not achieved. Analysis in this design cycle showed that the supplemental radiation protection could be reduced to 2 g/cm². **Figure 1-24** illustrates the progression of the configurations through Cycle 3 of the study as compared to Apollo and the attached table details the changes in diameter, sidewall angle, and volume. Data for Cycle 4 is also shown and is described in the following paragraphs.

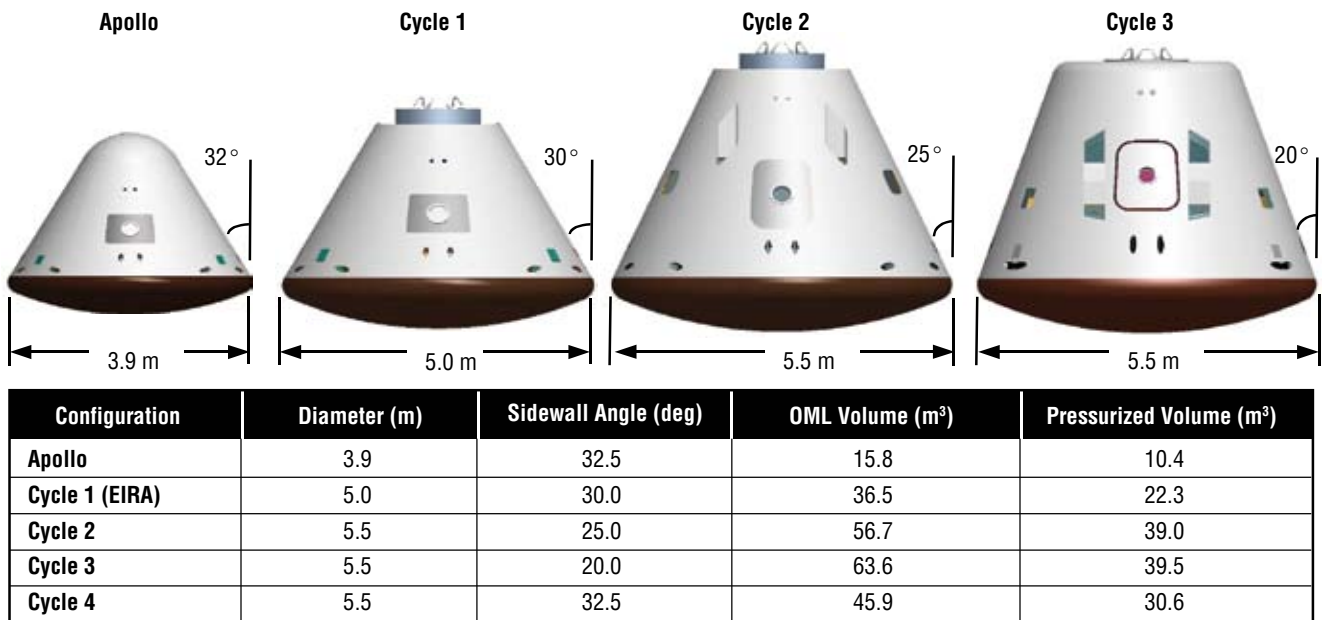

Figure 1-24. CEV CM Sizing Progression

Cycle 4 was the final CEV design cycle and began after the decision was made to no longer consider the lunar surface direct mission. The design implications to the CEV (i.e., difficulty including an airlock and complex operations), and the low mass margins surrounding the lunar surface direct mission mode were the primary reasons for taking the mode out of consideration. The Cycle 4 CEV was sized for a 2-launch EOR–LOR mission mode where the CEV performs a rendezvous with the EDS and LSAM in LEO, stays in lunar orbit while the LSAM descends to the lunar surface, and performs another rendezvous with the LSAM in lunar orbit. No supplemental radiation protection was included in the mass estimates for this design analysis due to results from a radiation study reported in **Section 4, Lunar Architecture**.

The resulting Cycle 4 CM shape is a geometric scaling of the Apollo Command Module. The vehicle is 5.5 m in diameter and the CM has a sidewall angle of 32.5 deg. The resulting CM pressurized volume is approximately 25 percent less than the Cycle 3 volume, but has almost three times the internal volume as compared to the Apollo Command Module. The CEV was ultimately designed for the EOR–LOR “1.5-launch solution” and volume reduction helps to reduce mass to that required for the mission. **Figure 1-25** depicts how vehicle sidewall angle and diameter affect pressurized volume and the resulting design point for each cycle.

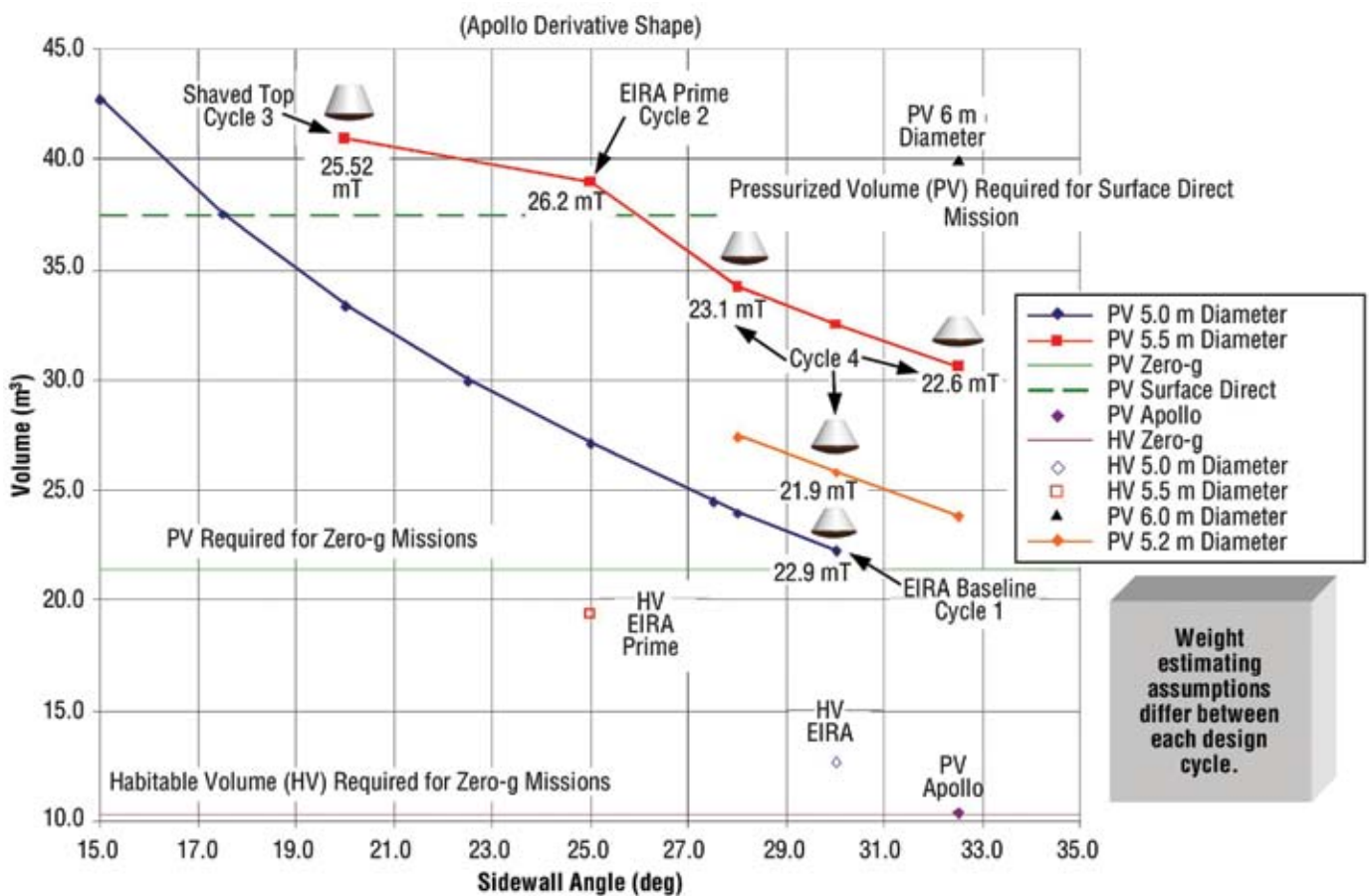

Figure 1-25. CEV Volume Relationships

1.4.4 CEV Recommendations

It is recommended that the CEV incorporate a separate CM, SM, and LAS arrangement similar to that of Apollo, and that these modules be capable of multiple functions to save costs. The CEV design was sized for lunar missions carrying a crew of four. Also, the vehicle was designed to be reconfigurable to accommodate up to six crew for ISS and future Mars mission scenarios. The CEV can transfer and return crew and cargo to the ISS and stay for 6 months in a quiescent state for nominal end of mission, or return of crew at any time in the event of an emergency. The lunar CEV design has direct applications to ISS missions without significant changes in the vehicle design. The lunar and ISS configurations share the same SM, but the ISS mission has much lower delta-V requirements. Hence, the SM propellant tanks can be loaded with additional propellant for ISS missions to provide benefits in launch aborts, on-orbit phasing, and ISS reboost. Other vehicle block derivatives can deliver pressurized and unpressurized cargo to the ISS.

The ESAS team's next recommendation addresses the vehicle shape. Using an improved blunt-body capsule for the CM was found to be the least costly, fastest, and safest approach for bringing ISS and lunar missions to reality. The key benefits for a blunt-body configuration were found to be lower weight, a more familiar aerodynamic design from human and robotic heritage (resulting in less design time and cost), acceptable ascent and entry abort load levels, crew seating orientation ideal for all loading events, easier LV integration, and improved entry controllability during off-nominal conditions. Improvements on the Apollo shape will offer better operational attributes, especially by increasing the Lift-to-Drag (L/D) ratio, improving CG placement, creating a more stable configuration, and employing a lower angle of attack for reduced sidewall heating.

A CM measuring 5.5 m in diameter was chosen to support the layout of six crew without stacking the crew members above or below each other. A crew tasking analysis also confirmed the feasibility of the selected vehicle volume. The recommended pressurized volume for the CM is approximately three times that of the Apollo Command Module. The available internal volume provides flexibility for future missions without the need for developing an expendable mission module. The vehicle scaling also considered the performance of the proposed CLV, which is a four-segment SRB with a single Space Shuttle Main Engine (SSME) upper stage. The CEV was scaled to maximize vehicle size while maintaining adequate performance margins on the CLV.

It is recommended that the CEV utilize an androgynous Low-Impact Docking System (LIDS) to mate with other exploration elements and the ISS. This requires the CEV-to-ISS docking adapters to be LIDS-compatible. It is proposed to develop small adapters to convert ISS interfaces to LIDS. The exact implementation is the source of further study.

An integrated pressure-fed LOX/methane service propulsion system/RCS propulsion system is recommended for the SM. Selection of this propellant combination was based on performance and commonality with the ascent propulsion system on the LSAM. The risk associated with this type of propulsion for a lunar mission can be substantially reduced by developing the system early and flying it to the ISS. There is high risk in developing a LOX/methane propulsion system by 2011, but development schedules for this type of propulsion system have been studied and are in the range of hypergolic systems.

Studies were performed on the levels of radiation protection required for the CEV CM. Based on an aluminum cabin surrounded by bulk insulation and composite skin panels with a Thermal Protection System (TPS), no supplemental radiation protection is recommended.

Solar arrays combined with rechargeable batteries were recommended for the SM due to the long mission durations dictated by some of the DRMs. The ISS crew transfer mission and long-stay lunar outpost mission require the CEV to be on orbit for 6 to 9 months, which is problematic for fuel cell reactants.

The choice of a primary land landing mode was primarily driven by a desire for land landing in the continental United States (CONUS) for ease and minimal cost of recovery, post-landing safety, and reusability of the spacecraft. However, it is recommended that the design of the CEV CM should incorporate both a water- and land-landing capability. Ascent aborts will require the ability to land in water, while other off-nominal conditions could lead the spacecraft to a land landing, even if not the primary intended mode. However, a vehicle designed for a primary land-landing mode can more easily be made into a primary water lander than the reverse situation. For these reasons, the study attempted to create a CONUS land-landing design from the outset, with the intention that a primary water lander would be a design off-ramp if the risk or development cost became too high.

In order for CEV entry trajectories from LEO and lunar return to use the same landing sites, it is recommended that NASA utilize skip-entry guidance on the lunar return trajectories. The skip-entry lunar return technique provides an approach for returning crew to a single CONUS landing site anytime during a lunar month. The Apollo-style direct-entry technique requires water or land recovery over a wide range of latitudes. The skip-entry includes an exoatmospheric correction maneuver at the apogee of the skip maneuver to remove dispersions accumulated during the skip maneuver. The flight profile is also standardized for all lunar return entry flights. Standardizing the entry flights permits targeting the same range-to-landing site trajectory for all return scenarios so that the crew and vehicle experience the same heating and loads during each flight. This does not include SM disposal considerations, which must be assessed on a case-by-case basis.

For emergencies, it is recommended that the CEV also include an LAS that will pull the CM away from the LV on the pad or during ascent. The LAS concept utilizes a 10-g tractor rocket attached to the front of the CM. The LAS is jettisoned from the launch stack shortly after second stage ignition. Launch aborts after LAS jettison are performed by using the SM propulsion system. Launch abort study results indicate a fairly robust abort capability for the CEV/CLV and a 51.6-deg-inclination ISS mission, given 1,200 m/s of delta-V and a Thrust-to-Weight (T/W) ratio of at least 0.25.

1.5 Launch Vehicles and Earth Departure Stages

1.5.1 Overview

A safe, reliable means of human access to space is required after the Space Shuttle is retired in 2010. As early as the mid-2010s, a heavy-lift cargo capability will be required, in addition to the crew launch capability to support manned lunar missions and follow-on missions to Mars. It is anticipated that robotic exploration beyond Earth orbit will have an annual manifest of five to eight spacecraft.

The ESAS team was chartered to develop and assess viable launch system configurations for a CLV and a CaLV to support lunar and Mars exploration and provide access to the ISS.

The ESAS team developed candidate LV concepts, assessed them against the ESAS FOMs (e.g., cost, reliability, safety, extensibility), identified and assessed vehicle subsystems and their allocated requirements, and developed viable development plans and supporting schedules to minimize the gap between Shuttle retirement and CEV IOC. The team developed LV concepts derived from elements of the existing EELV fleet and the Space Shuttle. A principal goal was to provide an LV capability to enable a CEV IOC in 2011.

Additional details on the LV trade studies and analysis results are contained in **Section 6, Launch Vehicles and Earth Departure Stages**.

1.5.2 Crew Launch Vehicle (CLV)

1.5.2.1 Results of CLV Trade Studies

A summary of the most promising CLV candidates assessed and key parameters (cost is normalized to the selected option) is shown in **Figure 1-26**.

The EELV options examined for suitability for crew transport were those derived from the Delta IV and Atlas V families. The study focused on the heavy-lift versions of both Delta and Atlas families, as it became clear early in the study that none of the medium versions of either vehicle had the capability to accommodate CEV lift requirements. Augmentation of the medium-lift class systems with solid strap-on boosters does not provide adequate capability and poses an issue for crew safety regarding small strap-on Solid Rocket Motor (SRM) reliability, as determined by the Orbital Space Plane-ELV (OSP-ELV) Flight Safety Certification Study report, dated March 2004. Both vehicles were assessed to require modification for human-rating, particularly in the areas of avionics, telemetry, structures, and propulsion systems.

Both Atlas and Delta derived systems required new upper stages to meet the lift and human-rating requirements. Both Atlas and Delta single-engine upper stages fly highly lofted trajectories, which can produce high deceleration loads on the crew during an abort and, in some cases, can exceed crew load limits as defined by NASA STD 3000, Section 5. Depressing the trajectories flown by these vehicles will require additional stage thrust to bring peak altitudes down to levels that reduce crew loads enough to have sufficient margins for off-nominal conditions. Neither Atlas V or Delta IV with their existing upper stages possess the performance capability to support CEV missions to ISS, with shortfalls of 5 mT and 2.6 mT, respectively.

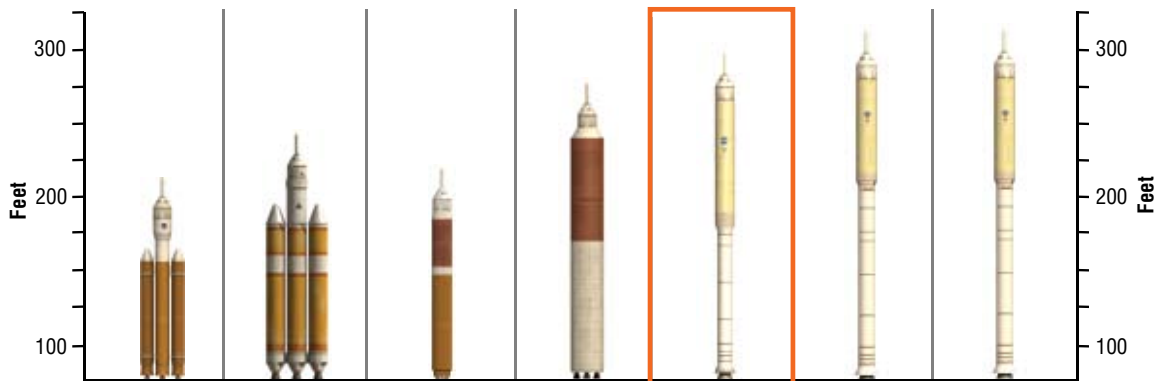

	Human-Rated Atlas V/New US	Human-Rated Delta IV/New US	Atlas Phase 2 (5.4-m Core)	Atlas Phase X (8-m Core)	4 Segment RSRB with 1 SSME	5 Segment RSRB with 1 J-2S	5 Segment RSRB with 4 LR-85
Payload (28.5°)	30 mT	28 mT	26 mT	70 mT	25 mT	26 mT	27 mT
Payload (51.6°)	27 mT	23 mT	25 mT	67 mT	23 mT	24 mT	25 mT
DDT&E*	1.18**	1.03	1.73**	2.36	1.00	1.3	1.39
Facilities Cost	.92	.92	.92	.92	1.00	1.00	1.00
Average Cost/Flight*	1.00	1.11	1.32	1.71	1.00	.96	.96
LOM (mean)	1 in 149	1 in 172	1 in 134	1 in 79	1 in 460	1 in 433	1 in 182
LOC (mean)	1 in 957	1 in 1,100	1 in 939	1 in 614	1 in 2,021	1 in 1,918	1 in 1,429

LOM: Loss of Mission LOC: Loss of Crew US: Upper Stage RSRB: Reusable Solid Rocket Booster

* All cost estimates include reserves (20% for DDT&E, 10% for Operations), Government oversight/full cost; Average cost/flight based on 6 launches per year.

** Assumes NASA has to fund the Americanization of the RD-180. Lockheed Martin is currently required to provide a co-production capability by the USAF.

Figure 1-26. Comparison of Crew LEO Launch Systems

Another factor in both vehicles is the very low T/W ratio at liftoff, which limits the additional mass that can be added to improve performance. The RD-180 first-stage engine of the Atlas HLV will require modification to be certified for human-rating. This work will, by necessity, have to be performed by the Russians. The RS-68 engine powering the Delta IV HLV first stage will require modification to eliminate the buildup of hydrogen at the base of the vehicle immediately prior to launch. Assessments of new core stages to improve performance as an alternative to modifying and certifying the current core stages for human-rating revealed that any new core vehicle would be too expensive and exhibit an unacceptable development risk to meet the goal of the 2011 IOC for the CEV. Note the EELV costs shown in **Figure 1-26** do not include costs for terminating Shuttle propulsion elements/environmental cleanup. Finally, both the EELV options were deemed high risk for a 2011 IOC.

CLV options derived from Shuttle elements focused on the configurations that used a Reusable Solid Rocket Booster (RSRB), either as a four-segment version nearly identical to the RSRB flown today or a higher-performance five-segment version of the RSRB using Hydroxyl Terminated Polybutadiene (HTPB) as the solid fuel. New core vehicles with ET-derived first stages (without SRBs) similar to the new core options for EELV were briefly considered, but were judged to have the same limitations and risks and, therefore, were not pursued. To meet the CEV lift requirement, the team initially focused on five-segment RSRB-based solutions. Three classes of upper stage engine were assessed—SSME, a single J-2S+, and a four-engine cluster of a new expander cycle engine in the 85,000-lbf vacuum thrust class. However, the five-segment development added significant near-term cost and risk and the J-2S+/expander engine could not meet the 2011 schedule target. Therefore, the team sought to develop options that could meet the lift requirement using a four-segment RSRB. To achieve this, a 500,000-lbf vacuum thrust class propulsion system is required. Two types of upper stage engine were assessed—a two-engine J-2S cluster and a single SSME. The J-2S option could not meet the 2011 target (whereas the SSME could) and had 6 percent less performance than the SSME-based option (LV 13.1). The SSME option offered the added advantages of an extensive and successful flight history and direct extensibility to the CaLV with no gap between the current Shuttle program and exploration launch. Past studies have shown that the SSME can be air-started, with an appropriate development and test program.

The 13.1 configuration was selected due to its lower cost, higher safety/reliability, its ability to utilize existing human-rated systems and infrastructure and the fact that it gave the most straightforward path to a CaLV.

1.5.2.2 Preferred CLV Configuration

The recommended CLV concept, shown in **Figure 1-27**, is derived from elements of the existing Space Shuttle system and designated as ESAS LV 13.1. It is a two-stage, series-burn configuration with the CEV positioned on the nose of the vehicle, capped by an LAS that weighs 9,300 lbm. The vehicle stands approximately 290 ft tall and weighs approximately 1.78M lbm at launch. LV 13.1 is capable of injecting a 24.5-mT payload into a 30-x-160 nmi orbit inclined 28.5 deg and injecting 22.9 mT into the same orbit inclined 51.6 deg.

Stage 1 is derived from the Reusable Solid Rocket Motor (RSRM) and is composed of four field-assembled segments, an aft skirt containing the Thrust Vector Control (TVC) hydraulic system, accompanying Auxiliary Power Units (APUs), and Booster Separation Motors (BSMs). The aft skirt provides the structural attachment to the Mobile Launch Platform (MLP) through four attach points and explosive bolts. The single exhaust nozzle is semi-embedded and is movable by the TVC system to provide pitch and yaw control during first-stage ascent. The Space Transportation System (STS) forward skirt, frustum, and nose cap are replaced by a stage adapter that houses the RSRB recovery system elements and a roll control system. Stage 1 is approximately 133 ft long and burns for 128 sec. After separation from the second stage, Stage 1 coasts upward in a ballistic arc to an altitude of approximately 250,000 ft, subsequently reentering the atmosphere and landing by parachute in the Atlantic Ocean for retrieval and reuse similar to the current Shuttle RSRB.



Figure 1-27. ESAS CLV Concept

Stage 2 is approximately 105 ft long, 16.4 ft in diameter, and burns LOX and Liquid Hydrogen (LH2). It is composed of an interstage, single RS-25 engine, thrust structure, propellant tankage, and a forward skirt. Near the conclusion of the ESAS, the CEV concept increased in diameter from 5 m to 5.5 m. Subsequent to the ESAS, LV 13.1 adopted a 5.5-m diameter, 100-ft long upper stage to accommodate the CEV. The interstage provides the structural connection between the Stage 1 adapter and Stage 2, while providing clearance for the RS-25 exhaust nozzle. The RS-25 is an expendable version of the current SSME, modified to start at altitude. The thrust structure provides the framework to support the RS-25, the Stage 2 TVC system (for primary pitch and yaw during ascent), and an Auxiliary Propulsion System (APS) which provides three-axis attitude control (roll during ascent and roll, pitch, and yaw for CEV separation), along with posigrade thrust for propellant settling. The propellant tanks are cylindrical, composed of Aluminum-Lithium (AL-Li) with ellipsoid domes, and are configured with the LOX tank aft, separated by an intertank. The LH2 main feedline exits the OML of the intertank and follows the outer skin of the LOX tank, entering the thrust structure aft of the LOX tank. The forward skirt is connected to the LH2 tank at the cylinder/dome interface and acts as a payload adapter for the CEV. It is of sufficient length to house the forward LH2 dome, avionics, and the CEV SM engine exhaust nozzle. Stage 2 burns for approximately 332 sec placing the CEV in a 30- x 160-nmi orbit. After separation from the CEV, Stage 2 coasts approximately a three-quarter orbit and reenters, with debris falling in the Pacific Ocean.

1.5.3 Cargo Launch Vehicle

1.5.3.1 Results of CaLV Trade Studies

A summary of the most promising CaLV candidates and key parameters is shown in **Figure 1-28**. (Note: Cost is normalized to the selected option.) The requirement for four or less launches per mission results in a minimum payload lift class of 70 mT. To enable a 2- or 1.5-launch solution, a 100- or 125-mT class system, respectively, is required.

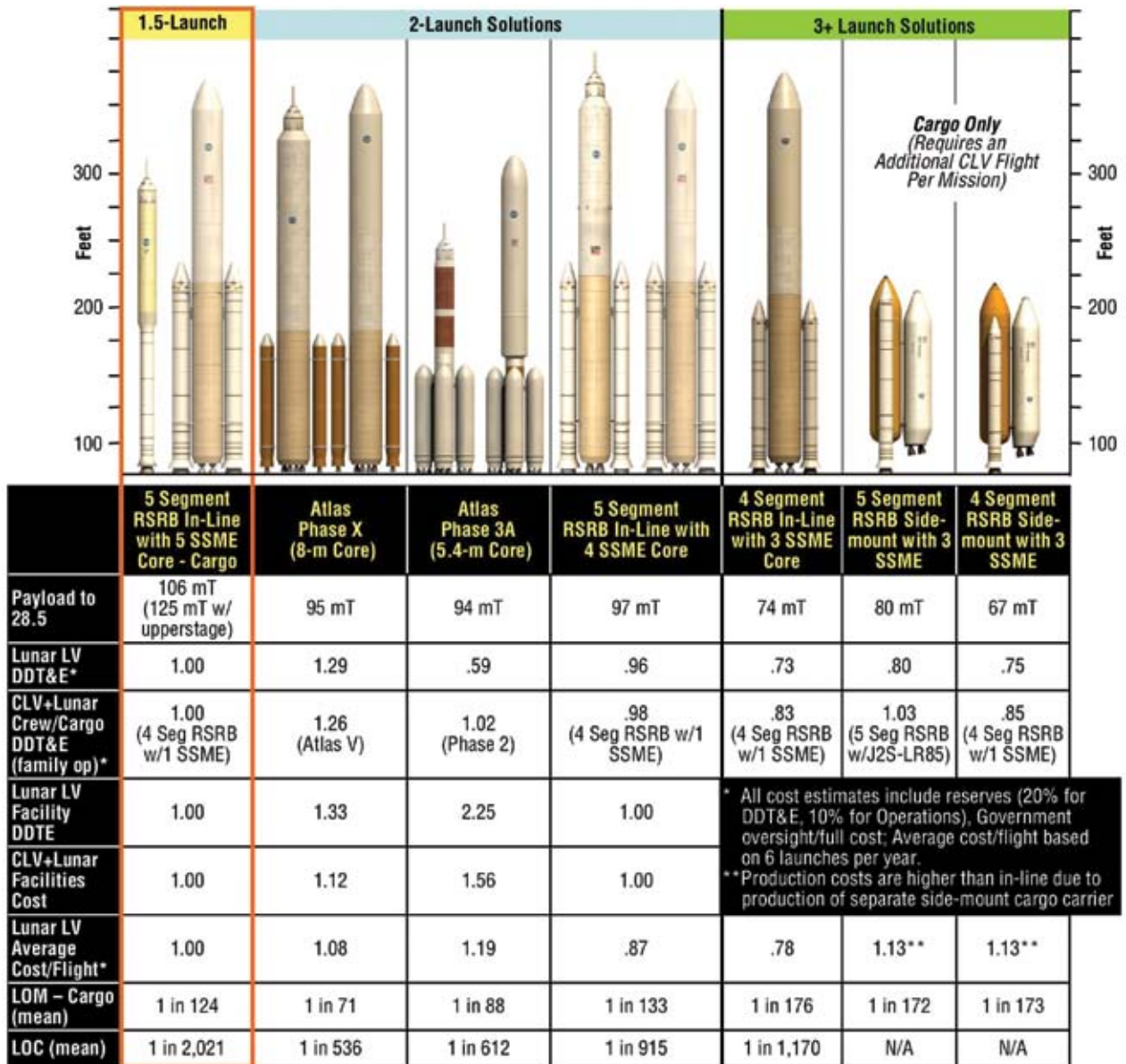

Figure 1-28. Lunar Cargo Launch Comparison

EELV-derived options for the CaLV included those powered by RD-180 and RS-68 engines, with core vehicle diameters of 5.4 and 8 m. No RS-68-powered variant of an EELV-derived heavy-lift cargo vehicle demonstrated the capability to meet the lunar lift requirements without a new upperstage and either new large liquid strap-on boosters or Shuttle RSRBs. The considerable additional cost, complexity, and development risk were judged to be unfavorable, eliminating RS-68-powered CaLVs. Hydrocarbon cores powered by the RD-180 with RD-180 strap-on boosters proved to be more effective in delivering the desired LEO payload. Vehicles based on both a 5.4-m diameter core stage and an 8-m diameter core were analyzed. A limitation exhibited by the EELV-Derived Vehicles (EDVs) was the low liftoff T/W ratios for optimized cases. While the EELV-derived CaLVs were able to meet LEO payload requirements, the low liftoff T/W ratio restricted the size of EDS in the suborbital burn cases. As a result, the Earth-escape performance of the EELV options was restricted. The 5.4-m core CaLV had an advantage in DDT&E costs, mainly due to the use of a single diameter core derived from the CLV which was also used as a strap-on booster. However, the CLV costs for this option were unacceptably high. (See **Section 1.5.2.1, Results of the CLV Trade Studies.**) In addition, there would be a large impact to the launch infrastructure due to the configuration of the four strap-on boosters (added accommodations for the two additional boosters in the flame trench and launch pad). Also, no EELV-derived concept was determined to have the performance capability approaching that required for a lunar 1.5-launch solution. Finally, to meet performance requirements, all EELV-derived CaLV options required a dedicated LOX/LH2 upper stage in addition to the EDS—increasing cost and decreasing safety/reliability.

The Shuttle-derived options considered were of two configurations: (1) a vehicle configured much like today's Shuttle, with the Orbiter replaced by a side-mounted expendable cargo carrier, and (2) an in-line configuration using an ET-diameter core stage with a reconfigured thrust structure on the aft end of the core and a payload shroud on the forward end. The ogive-shaped ET LOX tank is replaced by a conventional cylindrical tank with ellipsoidal domes, forward of which the payload shroud is attached. In both configurations, three SSMEs were initially baselined. Several variants of these vehicles were examined. Four- and five-segment RSRBs were evaluated on both configurations, and the side-mounted version was evaluated with two RS-68 engines in place of the SSMEs. The J-2S+ was not considered for use in the CaLV core due to its low relative thrust and the inability of the J-2S+ to use the extended nozzle at sea level, reducing its Specific Impulse (Isp) performance below the level required. No variant of the side-mount Shuttle-Derived Vehicle (SDV) was found to meet the lunar lift requirements with less than four launches. The side-mount configuration would also most likely prove to be very difficult to human-rate, with the placement of the CEV in close proximity to the main propellant tankage, coupled with a restricted CEV abort path as compared to an in-line configuration. The proximity to the ET also exposes the CEV to ET debris during ascent, with the possibility of contact with the leeward side TPS, boost protective cover, and the LAS. The DDT&E costs are lower than the in-line configurations, but per-flight costs are higher—resulting in a higher per-mission cost. The side-mount configuration was judged to be unsuitable for upgrading to a Mars mission LEO capability (100 to 125 mT). The in-line configuration in its basic form (four-segment RSRB/three-SSME) demonstrated the performance required for a three-launch lunar mission at a lower DDT&E and per-flight costs. Upgrading the configuration with five-segment RSRBs and four SSMEs in a stretched core with approximately one-third more propellant enables a 2-launch solution for lunar missions, greatly improving mission reliability. A final variation of the Shuttle-derived in-line CaLV was considered. This concept added a fifth SSME to the LV core, increasing its T/W ratio at

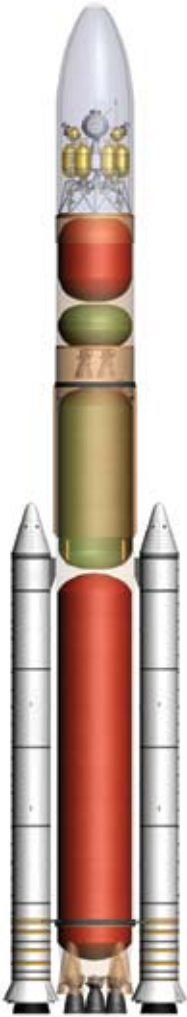

Figure 1-29. ESAS CaLV Concept

liftoff, thus increasing its ability to carry large, suborbitally ignited EDSs. LV 27.3 demonstrated an increased lift performance to enable a 1.5-launch solution for lunar missions, launching the CEV on the CLV and the LSAM and EDS on the larger CaLV. This approach allows the crew to ride to orbit on the safer CLV with similar LCCs and was selected as the reference. This configuration proved to have the highest LEO performance and lowest LV family non-recurring costs. When coupled with the four-segment RSRB/SSME-derived CLV (13.1), LOM and LOC probabilities are lower than its EELV-derived counterparts.

1.5.3.2 Preferred CaLV Configuration

The ESAS LV 27.3 heavy-lift CaLV, shown in **Figure 1-29**, is recommended to provide the cargo lift capability for lunar missions. It is approximately 357.5 ft tall and is configured as a stage-and-a-half vehicle composed of two five-segment RSRMs and a large central LOX-/LH2-powered core vehicle utilizing five RS-25 SSMEs. It has a gross liftoff mass of approximately 6.4M lbm and is capable of delivering 54.6 mT to TLI (one launch) or 124.6 mT to 30- x 160-nmi orbit inclined 28.5 deg.

Each five-segment RSRB is approximately 210 ft in length and contains approximately 1.43M lbm of HTPB propellant. It is configured similarly to the current RSRB, with the addition of a center segment. The operation of the five-segment RSRBs is much the same as the STS RSRBs. They are ignited at launch, with the five RS-25s on the core stage. The five-segment RSRBs burn for 132.5 sec, then separate from the core vehicle and coast to an apogee of approximately 240,000 ft. They are recovered by parachute and retrieved from the Atlantic Ocean for reuse.

The core stage carries 2.2M lbm of LOX and LH2, approximately 38 percent more propellant than the current Shuttle ET, and has the same 27.5-ft diameter as the ET. It is composed of an aft-mounted boattail which houses a thrust structure with five RS-25 engines and their associated TVC systems. The RS-25 engines are arranged with a center engine and four circumferentially mounted engines positioned 45 deg from the vertical and horizontal axes of the core to provide sufficient clearance for the RSRBs. The propellant tankage is configured with the LOX tank forward. Both the LOX and LH2 tanks are composed of Aluminum-Lithium (AL-Li) and are cylindrical, with ellipsoidal domes. The tanks are separated by an intertank structure, and an interstage connects the EDS with the LH2 tank. The core is ignited at liftoff and burns for approximately 408 sec, placing the EDS and LSAM into a suborbital trajectory. A shroud covers the LSAM during the RSRB and core stage phases of flight and is jettisoned when the core stage separates. After separation from the EDS, the core stage continues on a ballistic suborbital trajectory and reenters the atmosphere, with debris falling in the South Pacific Ocean.

1.5.4 Preferred EDS Configuration

The recommended configuration for the EDS, shown in **Figure 1-30**, is the ESAS S2B3 concept, which is 27.5 ft in diameter, 74.6 ft long, and weighs approximately 501,000 lbm at launch. The EDS provides the final impulse into LEO, circularizes itself and the LSAM into the 160-nmi assembly orbit, and provides the impulse to accelerate the CEV and LSAM to escape velocity. It is a conventional stage structure, containing two J-2S+ engines, a thrust structure/boattail housing the engines, TVC, auxiliary propulsion system, and other stage subsystems. It is configured with an aft LOX tank, which is comprised primarily of forward and aft domes. The LH2 tank is 27.5 ft in diameter, cylindrical with forward and aft ellipsoidal domes, and is connected to the LOX tank by an intertank structure. Both tanks are composed of AL-Li. A forward skirt on the LH2 tank provides the attach structure for the LSAM and payload shroud. The EDS is ignited suborbitally, after core stage separation and burns for 218 sec to place the EDS/LSAM into a 30- x 160-nmi orbit inclined 28.5 deg. It circularizes the orbit to 160 nmi, where the CEV docks with the LSAM. The EDS then reignites for 154 sec in a TLI to propel the CEV and LSAM on a trans-lunar trajectory. After separation of the CEV/LSAM, the EDS is placed in a disposal solar orbit by the APS.



Figure 1-30. ESAS EDS Concept

1.5.5 LV and EDS Recommendations

1.5.5.1 Recommendation 1

Adopt and pursue a Shuttle-derived architecture as the next-generation launch system for crewed flights into LEO and for 125-mT-class cargo flights for exploration beyond Earth orbit. After thorough analysis of multiple EELV- and Shuttle-derived options for crew and cargo transportation, Shuttle-derived options were found to have significant advantages with respect to cost, schedule, safety, and reliability. Overall, the Shuttle-derived option was found to be the most affordable by leveraging proven vehicle and infrastructure elements and using those common elements in the heavy-lift CaLV as well as the CLV. Using elements that have a human-rated heritage, the CaLV can enable unprecedented mission flexibility and options by allowing a crew to potentially fly either on the CLV or CaLV for 1.5-launch or 2-launch lunar missions that allow for heavier masses to the lunar surface. The Shuttle-derived CLV provides lift capability with sufficient margin to accommodate CEV crew and cargo variant flights to ISS and potentially provides added services, such as station reboost.

The extensive flight and test databases of the RSRB and SSME give a solid foundation of well-understood main propulsion elements on which to anchor next-generation vehicle development and operation. The Shuttle-derived option allows the Nation to leverage extensive ground infrastructure investments and maintains access to solid propellant at current levels. Furthermore, the Shuttle-derived option displayed more versatile and straightforward growth paths to higher lift capability with fewer vehicle elements than other options.

The following specific recommendations are offered for LV development and utilization.

1.5.5.2 Recommendation 2

Initiate immediate development of a CLV utilizing a single four-segment RSRB first stage and a new upper stage using a single SSME. The reference configuration, designated LV 13.1 in this study, provides the payload capability to deliver a lunar CEV to low-inclination Earth orbits required by the exploration architectures and to deliver CEVs configured for crew and cargo transfer missions to the ISS. The existence and extensive operational history of human-rated Shuttle-derived elements reduce safety, risk, and programmatic and technical risk to

enable the most credible development path to meet the goal of providing crewed access to space by 2011. The series-burn configuration of LV 13.1 provides the crew with an unobstructed escape path from the vehicle using an LAS in the event of a contingency event from launch through EOI. Finally, if required, a derivative cargo-only version of the CLV, designated in this report as LV 13.1S, can enable autonomous, reliable delivery of unpressurized cargo to ISS of the same payload class that the Shuttle presently provides.

1.5.5.3 Recommendation 3

To meet lunar and Mars exploration cargo requirements, begin development as soon as practical of an in-line Shuttle-derived CaLV configuration consisting of two five-segment RSRBs and a core vehicle with five aft-mounted SSMEs derived from the present ET and reconfigured to fly payload within a large forward-mounted aerodynamic shroud. The specific configuration is designated LV 27.3 in this report. This configuration provides superior performance to any side-mount Shuttle-derived concept and enables varied configuration options as the need arises. A crewed version is also potentially viable because of the extensive use of human-rated elements and in-line configuration. The five-engine core and two-engine EDS provides sufficient capability to enable the “1.5-launch solution,” which requires one CLV and one CaLV flight per lunar mission—thus reducing the cost and increasing the safety/reliability of each mission. The added lift capability of the five-SSME core allows the use of a variety of upper stage configurations, with 125 mT of lift capability to LEO. LV 27.3 will require design, development, and certification of a five-segment RSRB and new core vehicle, but such efforts are facilitated by their historical heritage in flight-proven and well-characterized hardware. Full-scale design and development should begin as soon as possible synchronized with CLV development to facilitate the first crewed lunar exploration missions in the middle of the next decade.

1.5.5.4 Recommendation 4

To enable the 1.5-launch solution and potential vehicle growth paths as previously discussed, NASA should undertake development of an EDS based on the same tank diameter as the cargo vehicle core. The specific configuration should be a suitable variant of the EDS concepts designated in this study as EDS S2x, depending on the further definition of the CEV and LSAM. Using common manufacturing facilities with the Shuttle-derived CaLV core stage will enable lower costs. The recommended EDS thrust requirements will require development of the J-2S+, which is a derivative of the J-2 upper stage engine used in the Apollo/Saturn program, or another in-space high performance engine/cluster as future trades indicate. As with the Shuttle-derived elements, the design heritage of previously flight-proven hardware will be used to advantage with the J-2S+. The TLI capability of the EDS S2x is approximately 65 mT, when used in the 1.5-launch solution mode, and enables many of the CEV/LSAM concepts under consideration. In a single-launch mode, the S2B3 variant can deliver 54.6 mT to TLI, which slightly exceeds the TLI mass of Apollo 17, the last crewed mission to the Moon in 1972.

1.5.5.5 Recommendation 5

Continue to rely on the EELV fleet for scientific and ISS cargo missions in the 5- to 20-mT lift range.

1.6 Technology Assessment

1.6.1 Overview

The Vision for Space Exploration set forth by President Bush cannot be realized without a significant investment in a wide range of technologies. Thus, a primary objective of the ESAS was to identify key technologies required to enable and significantly enhance the reference exploration systems and to prioritize near- and far-term technology investments. The product of this technology assessment is a revised ESMD technology investment plan that is traceable to the ESAS architecture and was developed by a rigorous and objective analytical process. The investment recommendations include budget, schedule, and Center/program allocations to develop the technologies required for the exploration architecture.

The three major technology assessment tasks were: (1) to identify what technologies are truly needed and when they need to be available to support the development projects; (2) to develop and implement a rigorous and objective technology prioritization/planning process; and (3) to develop ESMD Research and Technology (R&T) investment recommendations about which existing projects should continue and which new projects should be established.

Additional details on the technology trade studies and analysis results are contained in **Section 9, Technology Assessment**, of this report.

1.6.2 Technology Assessment Process

The baseline ESAS technology program was developed through a rigorous and objective process consisting of the following: (1) the identification of architecture functional needs; (2) the collection, synthesis, integration, and mapping of technology data; and (3) an objective decision analysis resulting in a detailed technology development investment plan. The investment recommendations include budget, schedule, and Center/program allocations to develop the technologies required for the exploration architecture, as well as the identification of other investment opportunities to maximize performance and flexibility while minimizing cost and risk. More details of this process are provided in **Appendix 9A, Process**.

The ESAS team's technology assessment included an Agency-wide Expert Assessment Panel (EAP). The team was responsible for assessing functional needs based on the ESAS architecture, assembling technology data sheets for technology project(s) that could meet these needs, and providing an initial prioritization of each technology project's contribution to meeting a functional need. This involved key personnel working full-time on ESAS as well as contractor support and consultation with technology specialists across NASA, as needed.

The EAP was a carefully balanced panel of senior technology and systems experts from eight NASA Centers. They examined the functional needs and technology data sheets for missing or incorrect entries, constructed new technology development strategies, and performed technology development prioritization assessment using the ESAS FOMs for each need at the architecture level. They provided internal checks and balances to ensure evenhanded treatment of sensitive issues.

All results were then entered into spreadsheet tools for use by the ESAS team in analyzing technology investment portfolio options. During the final step of the process, the ESAS team also worked with ESMD and the NASA Administrator's office to try to minimize Center workforce imbalance.

1.6.3 Architecture R&T Needs

This assessment was performed in parallel with the architecture development, requiring the ESAS team to coordinate closely to ensure that the technology assessment captured the latest architecture functional needs. The functional needs were traced element-by-element, for each mission, in an extensive spreadsheet tool. These needs were the basis for the creation of the technology development plans used in the assessment. Thus, all technology development recommendations were directly traceable to the architecture. This analysis indicated that R&T development projects are needed in the following areas:

- Structures and Materials,
- Protection,
- Propulsion,
- Power,
- Thermal Controls,
- Avionics and Software,
- Environmental Control and Life Support (ECLS),
- Crew Support and Accommodations,
- Mechanisms,
- ISRU,
- Analysis and Integration, and
- Operations.

These areas are described in additional detail in **Section 9, Technology Assessment**, of this report. Each area's section contains the description of its functional needs, the gaps between state-of-the-art and the needs, and the recommended developments. There is a more detailed write-up for each recommended technology development project listed in **Appendix 9B, Technology Development Activity Summaries**.

1.6.4 Recommendations

As a result of the technology assessment, it is recommended that the overall funding of ESMD for R&T be reduced by approximately 50 percent to provide sufficient funds to accelerate the development of the CEV to reduce the gap in U.S. human spaceflight after Shuttle retirement. This can be achieved by focusing the technology program only on those technologies required to enable the architecture elements as they are needed and because the recommended ESAS architecture does not require a significant level of technology development to accomplish the required near-term missions. Prior to the ESAS, the technology development funding profile for ESMD was as shown in **Figure 1-31**. The ESAS recommendations for revised, architecture-driven technology development is shown in **Figure 1-32**.

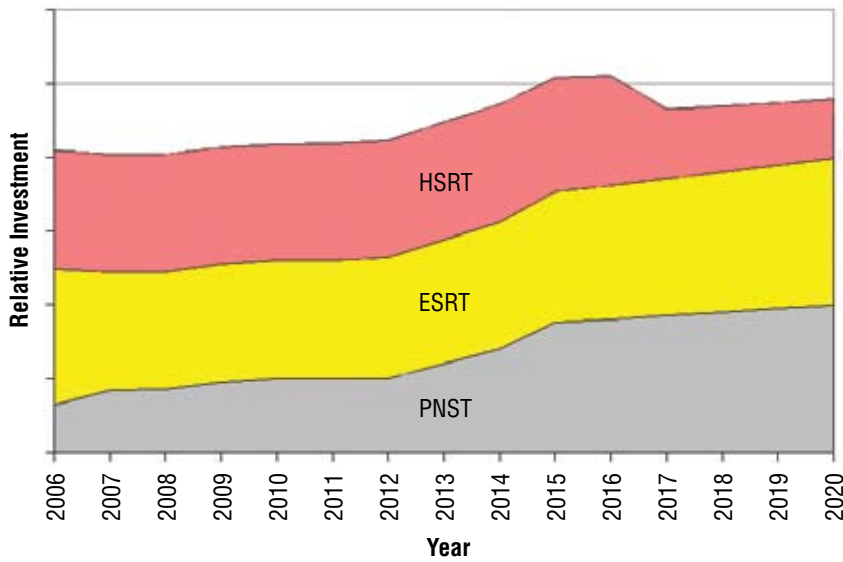

Figure 1-31. FY06–FY19 Original Funding Profile

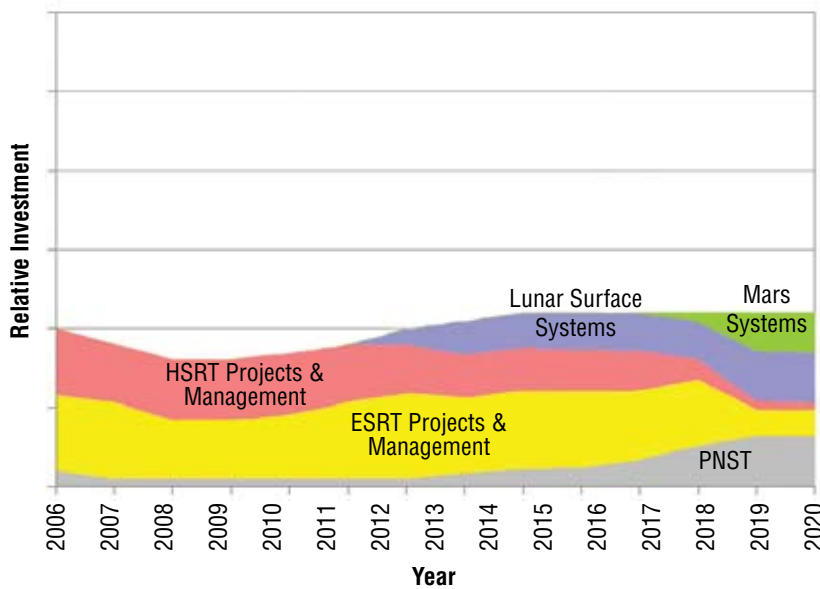

Figure 1-32. FY06–FY19 ESAS-Recommended Funding Profile

Figures 1-33 through 1-35 show, respectively, the overall recommended R&T budget broken out by program with liens, functional need category, and mission. “Protected” programs include those protected from cuts due to statutory requirements or previous commitments.

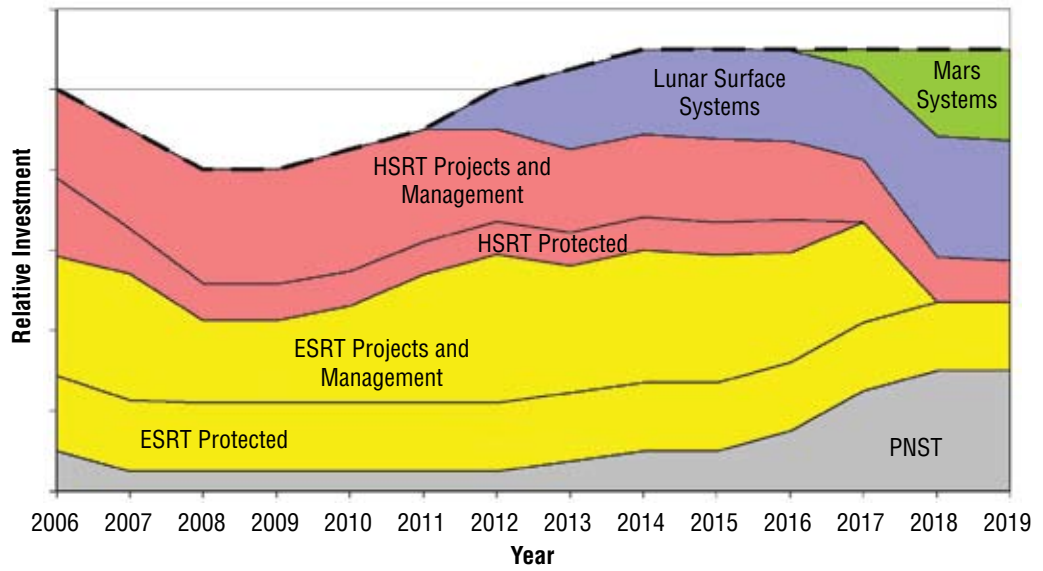

Figure 1-33. Overall Recommended R&T Budget Broken Out by Program with Liens

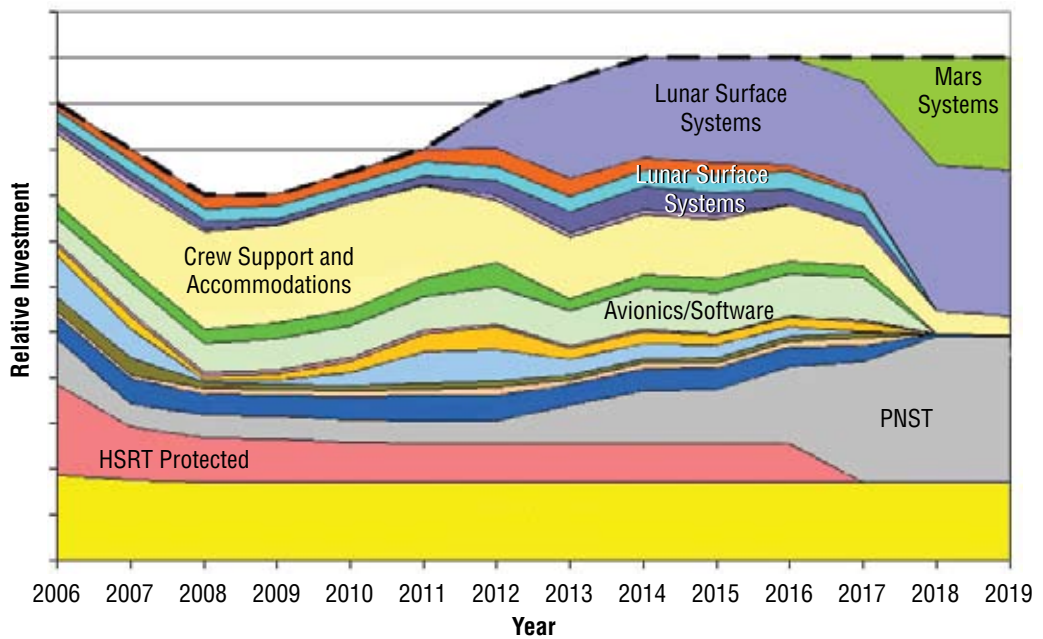

Figure 1-34. Overall Recommended R&T Budget Broken Out by Functional Need Category

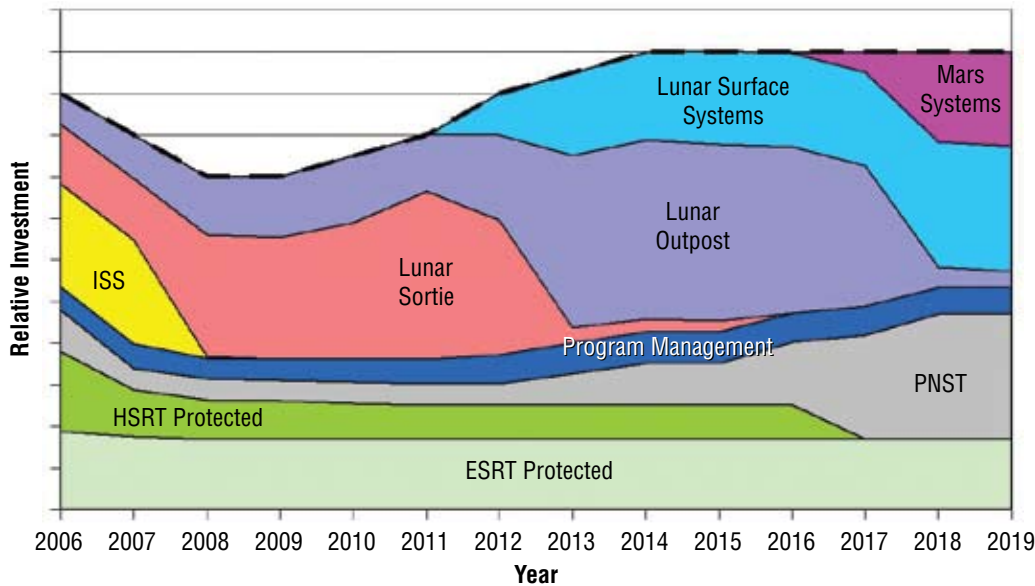

Figure 1-35. Overall Recommended R&T Budget Broken Out by Mission

The funding profile includes 10 percent management funds and approximately 30 percent liens due to prior agency agreements (e.g., Multi-User System and Support (MUSS), the Combustion Integrated Rack (CIR), and the Fluids Integrated Rack (FIR)) and legislated requirements (e.g., Small Business Innovation Research (SBIR), Small Business Technology Transfer (STTR)).

The final recommended technology funding profile was developed in coordination with the ESAS cost estimators using the results of the technology assessment.

Table 1-1.
Technology Project
Recommendations

Number	ESAS Control Number	Program	Category	New Projects
1	1A	ESRT	Structures	Lightweight structures, pressure vessel, and insulation.
2	2A	ESRT	Protection	Detachable, human-rated, ablative environmentally compliant TPS.
3	2C	HSRT	Protection	Lightweight radiation protection for vehicle.
4	2E	HSRT	Protection	Dust and contaminant mitigation.
5	3A	ESRT	Propulsion	Human-rated, 5–20 kbf class in-space engine and propulsion system (SM for ISS orbital operations, lunar ascent and TEI, pressure-fed, LOX/CH ₄ , with LADS). Work also covers 50–100 lbs nontoxic (LOX/CH ₄) RCS thrusters for SM.
6	3B	ESRT	Propulsion	Human-rated deep throttleable 5–20 kbf engine (lunar descent, pump-fed LOX/LH ₂).
7	3C	ESRT	Propulsion	Human-rated, pump-fed LOX/CH ₄ 5–20 kbf thrust class engines for upgraded lunar LSAM ascent engine.
8	3D	ESRT	Propulsion	Human-rated, stable, nontoxic, monoprop, 50–100 lbf thrust class RCS thrusters (CM and lunar descent).
9	3F	ESRT	Propulsion	Manufacturing and production to facilitate expendable, reduced-cost, high production-rate SSMEs.
10	3G	ESRT	Propulsion	Long-term, cryogenic, storage and management (for CEV).
11	3H	ESRT	Propulsion	Long-term, cryogenic, storage, management, and transfer (for LSAM).
12	3K	ESRT	Propulsion	Human-rated, nontoxic 900-lbf Thrust Class RCS thrusters (for CLV and heavy-lift upper stage).
13	4B	ESRT	Power	Fuel cells (surface systems).
14	4E	ESRT	Power	Space-rated Li-ion batteries.
15	4F	ESRT	Power	Surface solar power (high-efficiency arrays and deployment strategy).
16	4I	ESRT	Power	Surface power management and distribution (e.g., efficient, low mass, autonomous).
17	4J	ESRT	Power	LV power for thrust vector and engine actuation (nontoxic APU).
18	5A	HSRT	Thermal Control	Human-rated, nontoxic active thermal control system fluid.
19	5B	ESRT	Thermal Control	Surface heat rejection.
20	6A	ESRT	Avionics and Software	Radiation hardened/tolerant electronics and processors.
21	6D	ESRT	Avionics and Software	Integrated System Health Management (ISHM) (CLV, LAS, EDS, CEV, lunar ascent/descent, habitat/Iso new hydrogen sensor for on-pad operations).
22	6E	ESRT	Avionics and Software	Spacecraft autonomy (vehicles & habitat).
23	6F	ESRT	Avionics and Software	Automated Rendezvous and Docking (AR&D) (cargo mission).
24	6G	ESRT	Avionics and Software	Reliable software/flight control algorithms.
25	6H	ESRT	Avionics and Software	Detector and instrument technology.
26	6I	ESRT	Avionics and Software	Software/digital defined radio.

Table 1-1. (continued)
Technology Project
Recommendations

Number	ESAS Control Number	Program	Category	New Projects
27	6J	ESRT	Avionics and Software	Autonomous precision landing and GN&C (Lunar & Mars).
28	6K	ESRT	Avionics and Software	Lunar return entry guidance systems (skip entry capability).
29	6L	ESRT	Avionics and Software	Low temperature electronics and systems (permanent shadow region ops).
30	7A	HSRT	ECLS	Atmospheric management - CMRS (CO ₂ , Contaminants and Moisture Removal System).
31	7B	HSRT	ECLS	Advanced environmental monitoring and control.
32	7C	HSRT	ECLS	Advanced air and water recovery systems.
33	8B	HSRT	Crew Support and Accommodations	EVA Suit (including portable life support system).
34	8E	HSRT	Crew Support and Accommodations	Crew healthcare systems (medical tools and techniques, countermeasures, exposure limits).
35	8F	HSRT	Crew Support and Accommodations	Habitability systems (waste management, hygiene).
36	9C	ESRT	Mechanisms	Autonomous/teleoperated assembly and construction (and deployment) for lunar outpost.
37	9D	ESRT	Mechanisms	Low temperature mechanisms (lunar permanent shadow region ops).
38	9E	ESRT	Mechanisms	Human-rated airbag or alternative Earth landing system for CEV.
39	9F	ESRT	Mechanisms	Human-rated chute system with wind accommodation.
40	10A	ESRT	ISRU	Demonstration of regolith excavation and material handling for resource processing.
41	10B	ESRT	ISRU	Demonstration of oxygen production from regolith.
42	10C	ESRT	ISRU	Demonstration of polar volatile collection and separation.
43	10D	ESRT	ISRU	Large-scale regolith excavation, manipulation and transport (i.e., including radiation shielding construction).
44	10E	ESRT	ISRU	Lunar surface oxygen production for human systems or propellant.
45	10F	ESRT	ISRU	Extraction of water/hydrogen from lunar polar craters.
46	10H	ESRT	ISRU	In-situ production of electrical power generation (lunar outpost solar array fabrication).
47	11A	ESRT	Analysis and Integration	Tool development for architecture/mission/technology analysis/design, modeling and simulation.
48	11B	ESRT	Analysis and Integration	Technology investment portfolio assessment and systems engineering and integration.
49	12A	ESRT	Operations	Supportability (commonality, interoperability, maintainability, logistics, and in-situ fab.)
50	12B	ESRT	Operations	Human-system interaction (including robotics).
51	12C	ESRT	Operations	Surface handling, transportation, and operations equipment (Lunar or Mars).
52	12E	ESRT	Operations	Surface mobility.

1.7 Architecture Roadmap

As outlined in this executive summary, the ESAS team developed a time-phased, evolutionary architecture approach to return humans to the Moon, to service the ISS after Space Shuttle retirement, and to eventually transport humans to Mars. The individual elements were integrated into overall Integrated Master Schedules (IMSs) and detailed, multi-year integrated LCCs and budgets. These detailed results are provided in **Section 11, Integrated Master Schedule**, and **Section 12, Cost**, of this report. A top-level roadmap for ESAS architecture implementation is provided in **Figure 1-36**.

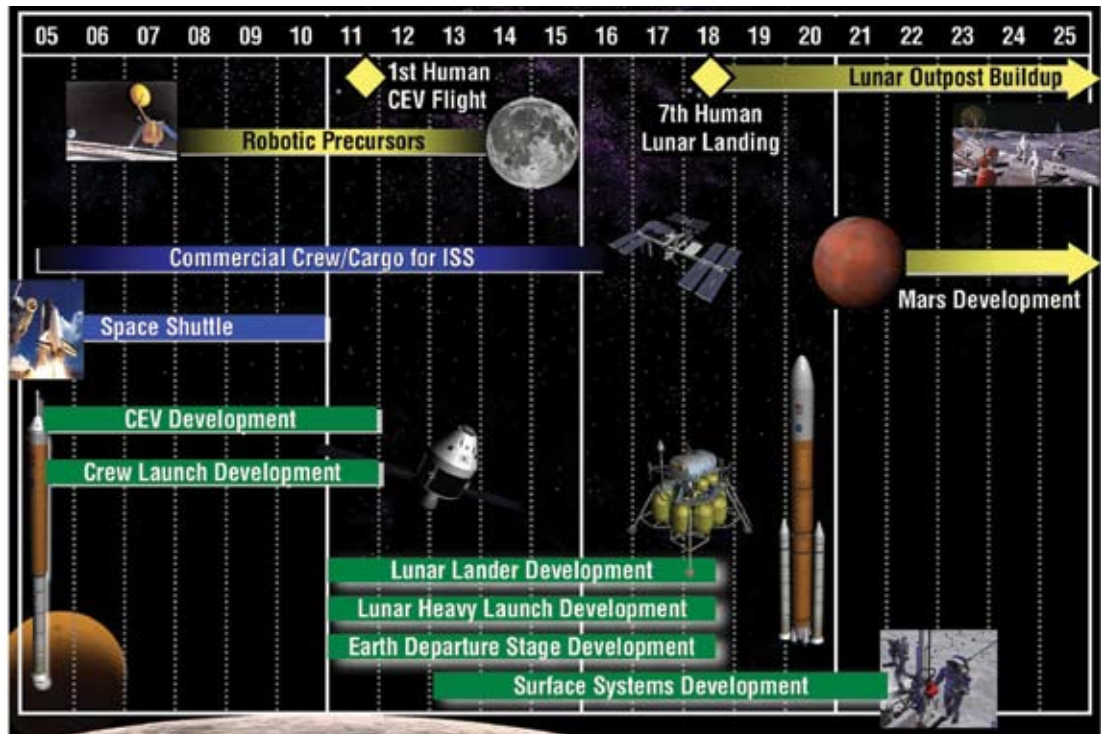

Figure 1-36.
ESAS Architecture
Implementation
Roadmap

In this implementation, the Space Shuttle would be retired in 2010, using its remaining flights to deploy the ISS and, perhaps, service the Hubble Space Telescope (HST). CEV and CLV development would begin immediately, leading to the first crewed CEV flight to the ISS in 2011. Options for transporting cargo to and from the ISS would be pursued in cooperation with industry, with a goal of purchasing transportation services commercially. Lunar robotic precursor missions would begin immediately with the development and launch of the Lunar Reconnaissance Orbiter mission and continue with a series of landing and orbiting probes to prepare for extended human lunar exploration. In 2011, development would begin of the major elements required to return humans to the Moon—the LSAM, CaLV, and EDS. These elements would be developed and tested in an integrated fashion, leading to a human lunar landing in 2018. Starting in 2018, a series of short-duration lunar sortie missions would be accomplished, leading up to the deployment and permanent habitation of a lunar outpost. The surface systems (e.g., rovers, habitats, power systems) would be developed as required. Lunar missions would demonstrate the systems and technologies needed for eventual human missions to Mars.

1.8 Architecture Advantages

The ESAS team examined a wide variety of architecture element configurations, functionality, subsystems, technologies, and implementation approaches. Alternatives were systematically and objectively evaluated against a set of FOMs. The results of these many trade studies are summarized in each major section of this report and in the recommendations in **Section 13, Summary and Recommendations**.

Although many of the key features of the architecture are similar to systems and approaches used in the Apollo Program, the selected ESAS architecture offers a number of advantages over that of Apollo, including:

- Double the number of crew to the lunar surface;
- Four times the number of lunar surface crew-hours for sortie missions;
- A CM with three times the volume of the Apollo Command Module;
- Global lunar surface access with anytime return to the Earth;
- Enabling a permanent human presence at a lunar outpost;
- Demonstrating systems and technologies for human Mars missions;
- Making use of in-situ lunar resources; and
- Providing significantly higher human safety and mission reliability.

In addition to these advantages over the Apollo architecture, the ESAS-selected architecture offers a number of other advantages and features, including:

- The Shuttle-derived launch options were found to be more affordable, safe, and reliable than EELV options;
- The Shuttle-derived approach provides a relatively smooth transition of existing facilities and workforce to ensure lower schedule, cost, and programmatic risks;
- Minimizing the number of launches through development of a heavy-lift CaLV improves mission reliability and safety and provides a launcher for future human Mars missions;
- Use of an RSRB-based CLV with a top-mounted CEV and LAS provides an order-of-magnitude improvement in ascent crew safety over the Space Shuttle;
- Use of an Apollo-style blunt-body capsule was found to be the safest, most affordable, and fastest approach to CEV development;
- Use of the same modular CEV CM and SM for multiple mission applications improves affordability;
- Selection of a land-landing, reusable CEV improves affordability;
- Use of pressure-fed LOX/methane propulsion on the CEV SM and LSAM ascent stage enables ISRU for lunar and Mars applications and improves the safety of the LSAM; and
- Selection of the “1.5-launch” EOR–LOR lunar mission mode offers the safest and most affordable option for returning humans to the Moon.

