

Space Solar Power Program

Final Report

International Space University
Kitakyushu, Japan
August, 1992

Dedication

This report is dedicated to the memory of Dr. Gerard K. O'Neill.
(1927-1992)

Dr. O'Neill pioneered the concept of harvesting the resources of space for the benefit of all humanity. He was an untiring proponent of Space Solar Power and his scholarly works, popular articles and books, including the award-winning The High Frontier, inspired many of our generation to careers in space. He founded the Space Studies Institute and served on the Board of Advisors of the International Space University since the Founding Conference in 1987.

Acknowledgements

The combined efforts of many people have made this report possible. First, we would like to thank all of our sponsors for making it possible for us to attend this ISU summer session and have the opportunity to work on the Space Solar Power Program project. Throughout the summer many distinguished speakers shared their knowledge and experience with us providing invaluable help in producing a quality report. We would like to thank them for taking the time to prepare their lectures and visit us in Kitakyushu. Special thanks goes to the entire ISU faculty and staff for their patience and perserverance in helping us during the trials and tribulations of producing the final report. The SSPP faculty and staff deserve recognition and our thanks for providing guidance and reviewing the report at each stage of its development, for staying up all night with us and putting up with last minute changes and panics. This report would not have been possible without the help of the computer staff keeping the fileserver and printers limping along under intensive workloads. Finally, we would especially like to thank the sponsors of the Space Solar Power Design Program.

Principal Sponsors:

National Aeronautics and Space Administration
U.S. Department of Energy
Hydro Québec
The City of Kitakyushu, Japan
Electricite de France

Contributors:

European Space Agency
Institute for Space and Astonautical Sciences
Société des Electriciens et des Electroniciens
Space Studies Institute
SUNSAT Energy Council
The Boeing Company
Kyushu Institute of Technology
Shimizu

We Acknowledge Continuing Support by:

Apple Computer, Inc.
C E Software
BioCom
PictureTel

Faculty Preface

The International Space University (ISU) held its 1992 summer session from June 16 to August 26 in Kitakyushu, Japan. ISU was hosted by the city of Kitakyushu. This is the fifth summer session since the inception of the International Space University summer sessions in 1988 at MIT. The ISU summer sessions consist of ten weeks of intense multidisciplinary lectures and workshops spanning all aspects of space studies. Introductory and advanced lectures are given in nine subjects: Space Architecture, Space Business & Management, Space Engineering, Space Life Sciences, Space Policy & Law, Space Resources & Manufacturing, Satellite Applications, Space Physical Sciences, and the Space Humanities program.

In addition to the ISU core curriculum and advanced lecture program, each ISU summer session includes one or more design projects. Spanning a portion of the ten week session, each ISU design project serves as a time-compressed simulation of a complete space design project. The purpose of the project is to give the students an opportunity to apply knowledge gained in ISU lectures and to participate in a multidisciplinary team endeavor with challenging technical, social and economic factors. The interaction among individual students, their work teams, and the external experts and faculty provides each student with a broad overview of a large project which is usually only obtained after years of experience. Typically only project managers, directors and corporate executives have the opportunity to see the "big picture" which the students of ISU achieve. This experience is the first and principal "product" of an ISU design project.

The second product of the ISU '92 Space Solar Power Program design project is this report. In it, the students describe a development plan for space solar power.

The design project responds to a growing perception in the space solar power research community that building a fleet of giant solar power satellites as envisioned in the 1970s is too costly and difficult a project for a first step. People have begun to realize that a systematic research and development program will have to be implemented in order to learn how to install solar power stations in space and to assess their potential for cost effective power production. Many demonstration projects have been proposed, but few institutions or agencies have looked at these to determine what the progression of projects should be to get from where we are now to global use of space solar power. For the Space Solar Power Project, the students were specifically asked not to create a point design of a large solar power satellite system. Instead, they were asked to build a development plan and, as part of this plan, to look at possible near and mid term demonstrations of space solar power technology. The work is unique, since such an overall plan — incorporating business, environmental, legal, technical, and other factors — has never been attempted. A set of possible demonstration projects has been examined by the students. A few of these have been worked out in some detail and others are left for future study. The early demonstrations could be deployed for technology validation and possibly to supply commercially useful amounts of power to other spacecraft. These demonstrations are possible steps to assess the overall viability of solar power plants capable of providing a significant amount of power to Earth.

The report covers many aspects of space solar power in addition to the engineering. For example, it addresses major political questions associated with frequency allocation for microwave power beaming, and discusses the environmental issues which must be understood before space solar power can become widely accepted.

Although the students have only limited time to work on such a large design project during a 10 week summer session, there are some creative ideas in this report and we have learned of new challenges that will have to be faced in the implementation of a Space Solar Power Program. We believe this report is a valuable addition to the literature on space solar power and will serve as a starting point for future research.

藤原 長友 長友 夫
H. Fujio H. Nagatomo
Barbosa Mexico
Pyrim
Francisco Seire Seiffers

J.H.G. +
Janet Glave
Robt. Auler
Flams
Margaret Roberts

Francis Jones
Rensu Cantu
Richard W. Wicks
Bas Theelen
Nova Spivack
M. PINTO

Richard Johnson
Richard Johnson
Richard Johnson
Richard Johnson



Lawrence M. Robertson U. Ph.D.
International Space University
Richard Johnson

Andre Berthe
Blythe
Jean J. Bouaille
Frank Wolf
"High" Arif

Andre Berthe
Blythe
Jean J. Bouaille
Frank Wolf
"High" Arif

Andre Berthe
Blythe
Jean J. Bouaille
Frank Wolf
"High" Arif

Andre Berthe
Blythe
Jean J. Bouaille
Frank Wolf
"High" Arif

Andre Berthe
Blythe
Jean J. Bouaille
Frank Wolf
"High" Arif

Authors

Humayun Arif	USA	Jyrki Laaksonen	FINLAND
Hugo Barbosa	MEXICO	Andrew Neill Lang	USA
Christophe Bardet	FRANCE	Corinna Lathan	USA
Michel Baroud	FRANCE	Thierry Le Fur	FRANCE
Alberto Behar	USA	David Lewis	CANADA
Keith Berrier	USA	Alain Louis	FRANCE
Philippe Berthe	FRANCE	Takeshi Mori	JAPAN
Reinhold Bertrand	GERMANY	Juan Morlanes	SPAIN
Irene Bibyk	USA	Marcus Murbach	USA
Joel Bisson	CANADA	Hideo Nagatomo	JAPAN
Lawrence Bloch	USA	Ivan O'Brien	IRELAND
Gabriel Bobadilla	SPAIN	Justin Paines	UNITED KINGDOM
Denis Bourque	CANADA	Bryan Palaszewski	USA
Lance Bush	USA	Ulf Palmnäs	SWEDEN
Romeo Carandang	USA	Marius Paraschivoiu	CANADA
Takemi Chiku	JAPAN	Asmin Pathare	USA
Norma Crosby	DENMARK	Egor Perov	RUSSIA
Manuel De Seixas	PORTUGAL	Jan Persson	SWEDEN
Joha De Vries	NETHERLANDS	Isabel Pessoa-Lopes	PORTUGAL
Susan Doll	USA	Michel Pinto	FRANCE
Francois Dufour	CANADA	Irene Porro	ITALY
Peter Eckart	GERMANY	Michael Reichert	GERMANY
Michael Fahey	USA	Monika Ritt-Fischer	GERMANY
Frédéric Fenot	FRANCE	Margaret Roberts	USA
Stefan Foeckersperger	GERMANY	Lawrence Robertson II	USA
Jean-Emmanuel Fontaine	BELGIUM	Keith Rogers	USA
Robert Fowler	CANADA	Tetsuo Sasaki	JAPAN
Harald Frey	GERMANY	Francesca Scire	ITALY
Hironobu Fujio	JAPAN	Katsuya Shibatou	JAPAN
Jaume Munich Gasa	SPAIN	Tatsuya Shirai	JAPAN
Janet Gleave	USA	Atsushi Shiraishi	JAPAN
Jostein Godø	NORWAY	Jean-François Soucaille	FRANCE
Iain Green	UNITED KINGDOM	Nova Spivack	USA
Roman Häberli	SWITZERLAND	Dany St Pierre	CANADA
Toshiya Hanada	JAPAN	Afzal Suleman	PORTUGAL
Peter Harris	UNITED KINGDOM	Thomas Sullivan	USA
Mario Hucteau	FRANCE	Bas Johan Theelen	NETHERLANDS
Didier Fernand Jacobs	BELGIUM	Hallvard Thonstad	NORWAY
Richard Johnson	USA	Masatoshi Tsuji	JAPAN
Yoshitsugu Kanno	JAPAN	Masaharu Uchiumi	JAPAN
Eva Maria Koenig	AUSTRIA	Jouni Vidqvist	FINLAND
Kazuo Kojima	JAPAN	David Warrell	UNITED KINGDOM
Phani Kondepudi	INDIA	Takafumi Watanabe	JAPAN
Christian Kottbauer	AUSTRIA	Richard Wills	USA
Doede Kuiper	NETHERLANDS	Frank Wolf	GERMANY
Konstantin Kulagin	RUSSIA	Hiroshi Yamakawa	JAPAN
Pekka Kumara	FINLAND	Hong Zhao	CHINA
Rainer Kurz	GERMANY		

Design Project Faculty

PROGRAM DIRECTOR

Gregg Maryniak Space Studies Institute, USA

TECHNICAL DIRECTOR

Masamichi Shigehara Kyushu Institute of Technology, JAPAN

FACULTY

Oleg Alifanov Moscow Aviation Institute, RUSSIA
Sheila Bailey NASA Lewis Research Center, USA
Henry Brandhorst NASA Lewis Research Center, USA
Mikhail Burgasov Moscow Aviation Institute, RUSSIA
Gay Canough ETM Inc., USA
Dieter Kassing European Space Agency, GERMANY
Nobuyuki Kaya Kobe University, JAPAN
Saburou Kuwajima National Space Development Agency, JAPAN
Michihiro Natori Institute for Space & Astronautical Science, JAPAN
Susumu Sasaki Institute for Space & Astronautical Science, JAPAN
Brent Sherwood Boeing Corp., USA
Brian Tillotson Boeing Corp., USA

PROJECT ASSISTANTS

Yasuhiro Akahoshi Kyushu Institute of Technology, JAPAN
Eric Dahlstrom Lockheed Corp., USA
Barbara McKissock NASA Lewis Research Center, USA
Fredric Nordlund Institute of Air and Space, CANADA

VISITING LECTURERS

Alan Brown	USA	Hiroshi Matsumoto	JAPAN
William Brown	USA	Shinji Matsumoto	JAPAN
T. Stephen Cheston	USA	Makoto Nagatomo	JAPAN
Patrick Collins	UK	Yoshihiro Naruo	JAPAN
Dennis Flood	USA	Hidenori Nishiwaki	JAPAN
Teruo Fujiwara	JAPAN	Stewart Nozette	USA
Shuichiro Fukuzawa	JAPAN	John Osepchuk	USA
Peter Glaser	USA	Knut Oxnevad	NORWAY
Toni Grobstein	USA	John D. G. Rather	USA
Iwao Igarashi	JAPAN	Bradford Schupp	USA
Anis Johnson	USA	Ron Schaffer	USA
Stewart Johnson	USA	Marc Simmons	CANADA
Fred Koomanoff	USA	Fumitaka Sugimura	JAPAN
Jiro Kouchiyama	JAPAN	Yoshiki Yamagiwa	JAPAN
Shinya Matsuda	JAPAN	Hiroyuki Yashiro	JAPAN



Table of Contents

1	Introduction.....	1
1.1	Vision for the Project.....	1
1.2	Space Solar Power Program Statement of Work.....	2
1.3	An Historical Perspective for Space Solar Power.....	3
1.4	General assumptions.....	6
2	Energy Analysis.....	11
2.1	Terrestrial Energy Demand and Models.....	11
2.1.1	Current Energy Consumption.....	11
2.1.2	Future Energy Consumption.....	14
2.1.3	Population Growth and Energy Demand Models.....	15
2.1.4	Conclusion.....	18
2.2	Terrestrial Energy Supply.....	18
2.2.1	Energy Sources.....	19
2.2.2	Major Uses and Conversion of Primary Energy.....	24
2.2.3	Cost of Terrestrial Energy.....	29
2.3	Space Energy.....	32
	Uses of Energy in space.....	32
	Locations of Energy Demand in Space.....	34
	Providing Space Power.....	34
	References.....	36
3	Markets.....	37
3.1	Market Analysis.....	37
3.1.1	Near-Term Applications.....	37
3.1.2	Mid-Term Applications.....	42
3.1.3	Long Term Markets.....	51
3.2	Marketing.....	53
3.2.1	Product identification.....	54
3.2.2	Players Involved.....	55
3.2.3	Potential/Spin-off Determination.....	55
3.2.4	Pricing.....	56
3.2.5	Promotion & Publicity.....	59
3.3	Marketing and Financing Schedule.....	60
	References.....	63
4	Overall Development Plan.....	65
4.1	Program Requirements.....	65
4.2	Identification of System Drivers.....	65
4.2.1	Political and Social.....	66
4.2.2	Environmental and Safety.....	67
4.2.3	Business.....	68
4.2.4	Technical.....	68
4.3	Technology Options.....	69
4.3.1	Power Options.....	69
4.3.2	Engineering Space Technologies.....	71
4.3.3	Space Transportation.....	72
4.4	Technology Development Plan.....	72
4.5	Non-technical versus Technical Interaction.....	78
4.6	Overall Schedule.....	80
	References.....	84
5	Organizational Plan.....	85
5.1	International Cooperation.....	85
5.1.1	New Factors in International Space Cooperation.....	85
5.1.2	Objectives in Space Under the New Regime.....	86
5.1.3	International Political Implications of the Space Solar Power Program.....	86

5.2	Organizational Structure	87
5.2.2	Management Structure	88
5.3	Legal Framework	93
5.3.1	Some Legal Aspects Of Outer Space	93
5.3.2	The Utilization Of Earth Orbits And Radio Frequency Spectrum	96
5.3.3	Technology Transfer & Intellectual Property	98
5.3.4	Some Responsibility And Liability Issues	99
5.3.5	Insurance	101
5.3.6	Dispute Resolution	101
5.3.7	Schedule	103
5.4	Security Issues	105
5.4.1	Technology Transfer	106
5.4.2	Increasing Vulnerability and Interdependency	106
5.4.3	Concluding Remarks	107
5.5	External Relations	108
5.5.1	External Relations with Governments, Industry and Int'l Organizations ..	108
5.5.2	Coordination with the Scientific Community	111
5.5.3	General Public	115
	References	124
6	Environmental and Safety Issues	125
6.1	Effects of Transmission of Energy	125
6.1.1	Propagation of the Beam through the Atmosphere	125
6.1.2	Electromagnetic Effects on Biota	128
6.1.3	Interference with Electronic Devices	138
6.2	Satellite Construction Effects	140
6.2.1	Launch Support Industry Effects	140
6.2.2	Launch Effects	140
6.2.3	On-Orbit Construction Effects	143
6.2.4	Lunar Operation Effects	151
6.3	Rectenna Effects	153
6.3.1	Construction	153
6.3.2	Climate and Socio-Economic Modification	154
6.4	Security and Maintenance	155
6.5	Planning and Scheduling	156
	References	159
7	Power Systems	163
7.1	Solar to Electric Conversion	163
7.1.1	Photovoltaics	163
7.1.2	Solar Dynamic Systems	168
7.1.3	Comparison of Photovoltaics with Solar Dynamic Systems	177
7.1.4	New Technologies	178
7.2	Power Transmission	184
7.2.1	Microwave Transmission	184
7.2.2	Laser	198
7.3	Receiver Location	205
7.4	Power Systems for Demonstrations	209
	References	210
8	Space Transportation	213
8.1	Operational Space Transportation Systems	213
8.1.1	Review and Analysis of Earth To Orbit Launchers	213
8.1.2	Piggy-back Options & Small Launch Vehicles	217
8.2	Review and Analysis of Upper Stages/Orbital Transfer Vehicles	222
8.2.1	Definitions	222
8.2.2	Present Status of Upper Stages/OTV's	224
8.2.3	OTV Analysis	224
8.2.4	Future In-Orbit Vehicles	226
8.3	Space Transportation Systems Under Development	229
8.4	Previous Studies	231
8.4.1	Satellite Power System (SPS) Reference Concept Description	232
8.4.2	Space Transportation Systems (STS) Studied	232

8.4.3	Previous Heavy Launchers.....	238
8.5	Future Space Transportation Systems.....	240
8.5.1	What is insufficient with today's Space Transportation infrastructure ?	240
8.5.2	Personnel Transport.....	241
8.5.3	Priority Cargo.....	244
8.5.4	Bulk.....	245
8.6	Technology Assumptions.....	245
8.6.1	Metallized Propellants.....	246
8.6.2	Lightweight Upper Stages.....	246
8.6.3	High Energy Density Propellants.....	247
8.6.4	Aerobrake/Aerocapture.....	247
8.6.5	Air Breathing Propulsion.....	247
8.6.6	Slush Hydrogen.....	248
8.6.7	In-Situ Propellants.....	248
8.6.8	Mass Drivers.....	248
8.6.9	Gun Propulsion.....	248
8.6.10	Laser Propulsion.....	248
8.6.11	Nuclear Thermal Propulsion.....	248
8.6.12	Materials.....	249
8.6.13	Mission Applications.....	250
8.7	Lunar Transportation.....	251
8.7.1	Conventional Chemical LO ₂ /LH ₂ Propulsion.....	251
8.7.2	Electric Propulsion.....	253
8.7.3	Nuclear Thermal Propulsion.....	255
8.7.4	Mass Driver.....	256
8.8	Scheduling.....	256
8.9	Conclusions.....	257
	References.....	258
9	Space Manufacturing, Construction, & Operations.....	259
9.1	A Matter of scale.....	259
	Problems on Earth.....	260
	The Lunar Solution.....	260
9.2	Structures.....	261
9.2.1	Modeling.....	261
9.2.2	Control.....	263
9.3	Construction/Assembly Operations.....	267
9.3.1	Construction of Erectable Structures.....	267
9.3.2	Deployable Structures.....	272
9.3.3	Schedule Issues for Deployable and Assembled Structures.....	276
9.4	Non-Terrestrial Resource Utilization.....	277
9.4.1	Lunar Resources.....	277
9.4.2	Other Non-terrestrial Resources.....	279
9.4.3	Non-terrestrial Resources Development Program Schedule.....	280
9.5	In-Space Manufacturing.....	283
9.5.1	Lunar Manufacturing.....	283
9.5.2	In-Space Manufacturing.....	284
9.5.3	Schedule Issues for Space Manufacturing Technology.....	284
10	Design Examples.....	291
10.1	Near-Term Earth to Space.....	291
10.1.1	Facilities.....	291
10.1.2	Orbital Considerations.....	293
10.1.3	Mission Objectives.....	295
10.1.4	Vehicle Configuration.....	296
10.2	Space to Space Demonstration.....	301
10.2.1	Mission Objectives.....	301
10.2.2	Mission Scenario.....	301
10.2.3	System Level Design.....	303
10.2.4	System Budgets and Scheduling.....	315
10.2.5	Conclusions.....	319
	References.....	321
10.3	Space to Earth Demonstration.....	322

10.3.1	Project Description.....	322
10.3.2	Mission Analysis.....	326
10.3.3	Space Segment.....	329
10.3.4	Ground Segment.....	347
10.3.5	Scheduling.....	348
10.3.6	Summary and Conclusions.....	349
References.....		354
10.4	Megawatt Class Demonstration.....	355
10.4.1	Constraints.....	355
10.4.2	Platform Design/Sizing.....	356
10.4.3	Concept Summary.....	371
10.4.4	Scheduling.....	377
10.4.5	Summary and Conclusions.....	379
References.....		381
11	Finance.....	383
11.1	Costing and Economic Analysis.....	383
11.1.1	Space Based Early Commercial Uses - Costing and Viability.....	383
11.1.2	Space to Earth.....	390
11.2.1	Financial Sources Overview.....	397
11.2.2	Financial Risk Analysis.....	400
11.2.3	Staged Plan for Financing.....	404
11.2.4	Financial Options for the SSPP staged plan.....	407
11.3.1	Financial Revenue Forecasts.....	409
11.3.2	Conclusions.....	414
References.....		417
Appendix A:	Summary of Proposed Design Examples.....	420
Appendix B:	Lunar Rover.....	424
Appendix C:	LEO Constellation of Small SPS.....	426
APPENDIX D:	Atmospheric Tester.....	434
Appendix E:	Feasibility Study of Laser Technology in the Space to Space Demonstration.....	436
Appendix F:	The ASAP / Viking Near Term Demonstration.....	440
Appendix G:	Scheduling: Macproject II.....	444
Appendix H:	Past and Current Space Solar Power Projects.....	448
Appendix I:	Questions to be Addressed.....	456
1	Economic/Business Issues.....	456
2	Demonstration-Specific Issues.....	457
3	Demonstration-Specific Issues.....	458
4	Political, Social, and Legal Issues.....	462
5	Technical Issues.....	464
6	Environmental and Safety Aspects.....	467
Appendix J:	Power Beaming for Orbital Transfer or Lunar Transfer Vehicle.....	472
Appendix K:	Low-Cost Launch Technology Demo For Earth to Orbit Propulsion.....	476

List of Figures

Figure 1.1 Artist's Impression of the RAMP	3
Figure 1.2 The NASA/DOE Reference SPS.....	4
Figure 1.3 The 1987 SHARP test airplane.....	5
Figure 1.4 Schematic for SPS2000.....	6
Figure 2.1 and 2.2 Energy Breakdown Results for the Years 1978 and 1991	13
Figure 2.3 Projected World Population until 2100	16
Figure 2.4 Future Energy Demand for Different Growth and Energy Consumption	16
Figure 2.5 Projected World Energy Shortfall	18
Figure 2.6 Assessment of Mix of Power Sources.....	29
Figure 2.7 Sequence of Operations for Primary Energy Sources	31
Figure 2.8 Comparative Fuel Costs for Cumulative U.S. Energy Demand	32
Figure 2.9 Propellant Usage Breakdown for a Sample Satellite in a 900 km Orbit.....	33
Figure 2.10 Power Breakdown for a Typical Satellite.....	33
Figure 3.1 Eclipse Lengths in Geostationary Orbit During Eclipse Season.....	44
Figure 3.2 Battery Masses for Communications Satellites	46
Figure 3.3 High and Low Predictions of Global Electricity Market	53
Figure 3.4 Simplified Macroeconomics Model between Energy and the Economy	57
Figure 3.5 Energy Cost Ranges for Different Power Generation Processes	59
Figure 3.6 Marketing Schedule.....	62
Figure 4.1 Top-Level Space Solar Power Program Requirements.....	65
Figure 4.2 Driving Requirements for Space Solar Power Program.....	69
Figure 4.3 Cost of using photovoltaic versus solar dynamic power.....	70
Figure 4.4 Space Solar Power Program	73
Figure 4.5 Overall Development Plan	77
Figure 4.6 Overall Space Solar Power Program Task Schedule.....	82
Figure 4.7 Timeline for Overall Space Solar Power Program	83
Figure 5.1 Organization Chart of the Management Structure	89
Figure 5.2: Responsibilities of the Scientific Branch	91
Figure 5.3: The Management Structure for the Space to Space Beaming Demo. (\$80M).....	93
Figure 5.4 Political and Legal Task Schedule	104
Figure 5.5 Political and Legal Tasks for Demo (1,2,3).....	105
Figure 5.6 Long Term Political and Legal Tasks	105
Figure 6.1 Atmospheric Attenuation vs Frequency at Sea-Level for Horizontal Propagation...	126
Figure 6.2 Transmission Efficiency - Molecular Absorption and Rain.....	127
Figure 6.3 Absorbency of retina according to wavelength.....	129
Figure 6.4 Microwave Irradiation and the Damage in Dog Eye.....	133
Figure 6.5 Microwave Irradiation and Cataracts on Rabbit	134
Figure 6.6 USA standard for Interference Levels for Electronic Medical Devices.....	139

Figure 6.7 Micrometeoroid Occurrence.....	143
Figure 6.8 Dose Equivalent as a Function of Aluminum	146
Figure 6.9 Near-Term Environmental Tasks	158
Figure 6.10 Long Term Environmental Tasks.....	158
Figure 7.1 Array Efficiency vs Time	166
Figure 7.2 Array Power vs Temperature	166
Figure 7.3 Possible Concentrator Collector Configurations.....	169
Figure 7.4 Relationship Between the Concentration Ratio and Temperature of the Receiver ..	170
Figure 7.5 Possible Satellite Configurations with Solar Dynamic Systems.....	171
Figure 7.6 Thermodynamic Efficiencies of Terrestrial Heat Engines	172
Figure 7.7 Organic Rankine Cycle Power System	172
Figure 7.8 Closed Brayton Cycle (CBC)Power System	173
Figure 7.9 Stirling Engine with Linear Alternator	173
Figure 7.10 Schematic of Space Station Freedom Proposed SDS	176
Figure 7.11 The SDS for Space Station Freedom	176
Figure 7.12 Cost Comparison for Space Station Freedom Power Generation	178
Figure 7.13 Model of a Thermoelectric Generator	179
Figure 7.14 Coaxial geometric TPV converter	180
Figure 7.15 Calculated Efficiency for Monochromatic Cells Coupled to Laser Light	181
Figure 7.16 Schematic view of a Gyroreactor	182
Figure 7.17 Liquid Droplet Radiator Concept.....	182
Figure 7.18 Comparison of Specific Power for LDR and Heat Pipe Radiator	183
Figure 7.19 Mass Comparison for LDR and Heat Pipe Radiator (100 kW Nuclear Stirling) ..	183
Figure 7.20 Mainlobe Radiation Pattern.....	184
Figure 7.21 Rectenna Efficiency.....	185
Figure 7.22 Power Distribution at Rectenna.....	186
Figure 7.23 Slotted Waveguide Radiator	187
Figure 7.24 Integrated Solar Cell and Solid State Amplifiers.	187
Figure 7.25 Two Tone Pilot-Signal Retrodirective Antenna	188
Figure 7.26 Atmospheric Attenuation Across the Radio Microwave and Millimeter Regions .	189
Figure 7.27 Atmospheric Attenuation Due to the Rain and Fog	190
Figure 7.28 Penetration Depth as a Function of the Frequency for Snow	190
Figure 7.29 Simplified electrical schematic for an early rectenna element	193
Figure 7.30 Photograph of an early rectenna element	193
Figure 7.31 Solar Cell with Microwave Antenna, (conceptual design)	196
Figure 7.32 Antenna Paddle	197
Figure 7.33 Examples of Optical Pumping Lines in Solar Energy.	199
Figure 7.34 Indirect Solar Pumped Laser.	199
Figure 7.35 Operation of Indirect Solar Pumped Laser.	200
Figure 7.37 Absorbing Sphere Concept.....	202
Figure 7.36 Optical Rectenna Configuration.	203

Figure 7.39 Possible Offshore Rectenna Sites in the North Sea	206
Figure 7.40 Preferred Construction for Offshore Rectenna Site	207
Figure 7.38 Possible Rectenna Site Locations in Continental United States	208
Figure 7.41 Schedule Tasks for Power Systems - Demo 3.....	209
Figure 7.42 Power System Tasks For Large Scale Demo	209
Figure 8.1 OMV/OTV Missions.....	222
Figure 8.2 Example of Type 4.....	223
Figure 8.3 OTV Concept for a Three Satellite LEO to GEO.....	226
Figure 8.4 The Ariane 5 launcher.....	229
Figure 8.5 Payload accommodation on Ariane 5.....	230
Figure 8.6 Payload accommodation on H-2.....	231
Figure 8.7 The Taurus Launcher [Isakowitz, 1991].....	231
Figure 8.8 SPS GEO Construction Concept.....	232
Figure 8.9 Boeing Studies and Comparison with Existing Launchers.....	233
Figure 8.10 Rockwell Configuration.....	233
Figure 8.11 Boeing Configuration.....	234
Figure 8.12 Rockwell Configuration.....	234
Figure 8.13 Cargo Electric OTV.....	235
Figure 8.14 Personnel OTV.....	236
Figure 8.15 Total Transportation Cost Summary (in "1980s" millions).....	236
Figure 8.16 SPS Space Transportation Costs.....	237
Figure 8.17 Development Planning (in 1980).....	237
Figure 8.18 Ratio of Thrust to Weight for Different Propulsion Systems.....	252
Figure 8.19 Space Vehicles of a Lunar Transportation System.....	253
Figure 8.20 Nuclear Electric LTV.....	254
Figure 8.21 Propulsion Technology Comparison and Trip Time.....	254
Figure 8.22 An Example of 300 KW Solar Electric OTV.....	255
Figure 8.23 Research and Development Tasks for Space Transportation Technologies.....	257
Figure 8.24 Advanced Space Transportation Development Tasks.....	257
Figure 9.1 Block diagram of Reduced Order Model Design.....	267
Figure 9.2 Reduced Order Model design with improved Residual Mode Filter.....	267
Figure 9.3 All possible box truss configurations that are possible by flipping the diagonal members on each of the six faces.....	270
Figure 9.4 Top and side view of a planer tetrahedral truss.....	271
Figure 9.5 Five candidate trusses. Notice concept A, C, D and E	272
Figure 9.6 Number of columns per square kilometer in a tetrahedral truss as a function of column length.....	272
Figure 9.7 (a) Beam Deployment Concepts (b) Tetrahedral Fold.....	274
Figure 9.8 (a) Octet Fold (b) Parabolic Surface Truss.....	275
Figure 9.9 (a) Fabrication Method (b) 2-Dimensional Deployment.....	275
Figure 9.10 (a) Modularized Inflatable (b) Rigidized Inflatable.....	276
Figure 9.11 Adaptive structure.....	276

Figure 9.12 Construction, Assembly, and Deployment Task Schedule	277
Figure 9.13 Average Lunar Soil Composition.....	279
Figure 9.14 Non-Terrestrial Resource Utilization Task Schedule.....	283
Figure 9.15 In-Space Manufacturing Task Schedule.....	287
Figure 10.1.1 Arecibo Observatory, Puerto Rico	292
Figure 10.1.2 Tracking rates for Satellites at Various Altitudes.....	293
Figure 10.1.3 Arecibo Viewing Geometry	293
Figure 10.1.4 Trade-offs for Altitude Choice.(Arecibo Radar).....	294
Figure 10.1.5 Number of Passages over Arecibo Orbits During the Year 1992.....	295
Figure 10.1.6 Inflatable Receiver Concept.....	297
Figure 10.2.2 Mir-Progress Docking Configuration.....	302
Figure 10.2.3 Demonstration Scenario.....	303
Figure 10.2.4 Flight Operation Flowchart.....	304
Figure 10.2.5 Phased Array Antenna.....	305
Figure 10.2.6 Phased Array Functional Diagram.....	306
Figure 10.2.7 Antenna System Layout.....	307
Figure 10.2.8 Phase Control.....	307
Figure 10.2.9 Beam Cone.....	308
Figure 10.2.10 Positioning of Antenna and Rectenna	311
Figure 10.2.11 Deployment of the Rectenna.....	311
Figure 10.2.12 Shading of the Rectenna.....	313
Figure 10.2.13 Experiment Functional Block Diagram.....	314
Figure 10.2.14 Power Budget.....	315
Figure 10.2.15 Task Chart (Demonstration 1).....	317
Figure 10.2.16 Timeline (Demonstration 1).....	318
Figure 10.2.17 Work Break Down Structure.....	319
Figure 10.3.1 Satellite Configuration.....	330
Figure 10.3.2 Calculations for SGD-1	331
Figure 10.3.3 Retrodirective Cell Architecture.....	332
Figure 10.3.4 SGD-1 Platform Structure Design.....	333
Figure 10.3.5 SGD-1 Satellite Stowed Configuration.....	334
Figure 10.3.6 Thermal Space Environment.....	335
Figure 10.3.7 Efficiency of SDG-1 Phased Array.....	336
Figure 10.3.8 Spacecraft Attitude Control.....	339
Figure 10.3.9 Electrical Architecture.....	340
Figure 10.3.10 Possible Deployed Satellite Configurations.....	344
Figure 10.3.11 Schematic of a Satellite in Orbit.....	345
Figure 10.3.12 Solar Dynamic Concepts Using a Gyroreactor	346
Figure 10.3.13 Ground Segment Configuration	348
Figure 10.3.14 Demo 2 Tasks.....	350
Figure 10.3.15 Demo 2 Schedule Timeline.....	351

Figure 10.4.1 Erection of the First 5m Segment.....	357
Figure 10.4.2 First 5 Segments from the Shuttle Cargo Bay.....	357
Figure 10.4.3 The Dual-keel Space Station.....	359
Figure 10.4.4 Erection of the Mars Mission Vehicle Assembly Bay.....	359
Figure 10.4.5 Outline of Launch and Assembly Sequence.....	360
Figure 10.4.6 Angular Convention.....	361
Figure 10.4.7 Sun Power Vs. Angular Position.....	362
Figure 10.4.8 Drag Compensation Velocity Increment Requirements.....	365
Figure 10.4.9 Basic Orbit Transfer Options.....	367
Figure 10.4.10 Hybrid Orbit Transfer.....	368
Figure 10.4.11 1 MW Planar Array Demonstrator.....	373
Figure 10.4.12 1 MW Pre-commercial Demonstrator.....	375
Figure 10.4.13 Large Planar Array.....	377
Figure 10.4.14 1 MW Prototype Task Schedule.....	378
Figure 10.4.15 1 MW Prototype Timeline.....	378
Figure 10.4.16 Phase C/D Task Schedule.....	379
Figure 10.4.17 Phase C/D Timeline.....	379
Figure 11.1 Sensitivity Analysis Curve of Spacecraft, Transportation and Ground Segments..	392
Figure 11.2 Conversion and Power Transmission Systems Costs in Spacecraft Segment.....	394
Figure 11.3 Sensitivity Analysis of HLLV Costs in Transportation Segment.....	395
Figure 11.4 Rectenna Structure and Power Collection on Ground Receiving Station Segment.	396
Figure 11.5 Staged Plan for ISPO Financing.....	405
Figure 11.6 Viability of Space to Earth Solar Power Satellite Operation.....	412
Figure 11.7 Revenues and Costs for 120 5GW SPS Operation.....	413
Figure 11.8 Revenues and Costs, including 3% Capital Cost, for 120 5 GW SPS Operation....	414

List of Tables

Table 2.1 Inherent Characteristics of Primary Energy Sources.....	20
Table 2.2 Operational Considerations Imposed by Different Energy Sources.....	22
Table 2.3 Delivered Fossil Fuel Prices, 1978\$/kWh	30
Table 3.1 Recent Intelsat Communications Satellites.....	45
Table 3.2 Duty Cycle and Mass Savings for Servicing of Degraded Solar Panels.....	48
Table 3.3 Revenue of New York State Electricity and Gas Corporation Spent, 1990	56
Table 3.4 Funding Sources for the Space Solar Power Program	61
Table 4.1 Space Solar Power Program Demonstration Requirements.....	66
Table 4.2 Trade between photovoltaic and solar dynamic power for Space Station Freedom....	70
Table 4.3 Issue Priorities.....	74
Table 4.4 Issue Timing.....	75
Table 5.1 Legal Questions, Tasks and Durations.....	103
Table 6.1 Frequencies to be Investigated in More Detail.....	125
Table 6.2 Microwave safety standards in the USA.....	132
Table 6.3 Threshold of the microwave intensity and.....	134
Table 6.4 Threshold of the microwave intensity and.....	134
Table 6.5 Major Non-Thermal Microwave-Effects Reported.....	135
Table 6.6 NASA Astronaut Organ Dose - Equivalent Radiation.....	146
Table 6.7 Possible Events Leading to Requirement for.....	148
Table 7.1 Technical Development Required In Thermodynamic Power cycles	173
Table 7.2 Chemical Reaction in Hydrogen Fluoride Laser	201
Table 8.1 Operational Launchers.....	216
Table 8.2: Small Launch Vehicles.....	221
Table 8.3: Main Characteristics of OTV-like vehicles.....	224
Table 8.4 Average Commercial Payloads Per Year.....	225
Table 8.5 Chemical Propulsion OTV Mass Summary*	228
Table 8.6 Electric Propulsion OTV Mass Summary*	228
Table 8.7 Historical Launchers.....	239
Table 8.8 Space Planes.....	243
Table 8.9 Engine performance - comparison between F-1 and RD-170	245
Table 8.10 Propulsion System Performance for Future Applications	254
Table 9.1 Classes of Permanent Joining Systems.....	268
Table 9.2 US. Neutral Buoyancy Facilities	268
Table 9.3 ACCESSAssembly Times vs. NBS Times.....	269
Table 9.4 Selection Criteria and Concept Evaluation (with bold dilating best choice).....	271
Table 9.5 Advantages and Disadvantages of Erectable Systems.....	273
Table 9.6 Advantages and Disadvantages.....	276
Table 10.1.1 Preliminary Calculations for Transmission from Arecibo.....	298

Table 10.2.1 Power Cable Equilibrium Temperature.....	310
Table 10.2.2 Data Budget Estimation.....	314
Table 10.2.3 Mass Budget.....	316
Table 10.2.4 Cost Estimation.....	320
Table 10.3.1 Detectors on UARS and their main function [Kendall, 1992].....	323
Table 10.3.2 Altitude Selction Trade-Off Analysis.....	326
Table 10.3.3 Orbital Selection Trade-Off Analysis.....	327
Table 10.3.4 Frequency Trade-Off Analysis.....	328
Table 10.3.5 System Power Budget.....	328
Table 10.3.6 Solar Cell Trade-Off Analysis.....	329
Table 10.3.7 SGD-1 Orbit.....	335
Table 10.3.8 Environmental Fluxes.....	335
Table 10.3.9 SDG-1 Passive Thermal Control.....	336
Table 10.3.10 Active Thermal Control.....	337
Table 10.3.11 Requirements and Design Drivers.....	337
Table 10.3.12 Spacecraft Cost Breakdown.....	343
Table 10.3.13 Cost Summary of the Solar Dynamic Subsystem.....	347
Table 10.3.14 Demo 2 Schedule.....	349
Table 10.3.15 Power Budget.....	352
Table 10.3.16 Preliminary Allocation.....	353
Table 10.4.1 Visibility for Various Orbits.....	355
Table 10.4.2 Propellant Masses.....	366
Table 10.4.3 Mass Summary For Structure.....	370
Table 10.4.4 Concept 0 SPS-2000.....	371
Table 10.4.5 Concept 1 1MW Mid term Demonstrator.....	372
Table 10.4.6 Mass and Cost Summaries for Concept 1.....	373
Table 10.4.7 Concept 2 1 MW Commercial Pre-cursor.....	374
Table 10.4.8 Mass and Cost Summaries for Concept 2.....	374
Table 10.4.9 Concept 3 Futuristic Large Planar Array.....	376
Table 10.4.10 Mass and Cost Summaries for Concept 3.....	376
Table 11.1 NPV - Near Term Ground to Space Laser.....	385
Table 11.2 NPV - Mid Term Ground to Space Laser.....	386
Table 11.3 NPV - Mid term Ground to Space Microwave.....	387
Table 11.4 NPV - Mid Term Space to Space.....	389
Table 11.5 NPV - Mid Term Space to Space Baseline 2.....	390
Table 11.6 Full Scale SPS Program Costs.....	391
Table 11.7 Full Scale SPS Recurring Costs.....	392
Table 11.8 Spacecraft Segment Cost.....	393
Table 11.9 Space Construction and Support Segment Costs.....	394
Table 11.10 Transportation Segment Costs.....	395
Table 11.11 Ground Receiving Station Costs.....	396

Table 11.12 Management and Integration Costs	396
Table 11.13 Government Funding Opportunities.....	399
Table 11.14 Demo Stages Of The Project.	399
Table 11.15 Example of Satellite Replacement Cost or 0% Return on Invested Capital.....	410
Table 11.16 Examples of Satellite Replacement Cost for 3% Return on Invested Capital	411
Table 11.17 Satellite Replacement Costs.....	411

List of Acronyms (LOA)

a-Si	Amorphous Silicon
AC	Alternating Current
ACCESS	Assembly Concept for Construction of Erectable Space Structures
ACE	Altitude Control Electronics
ACFS	Altitude Control Flight Software
ACRONYM	Any Complex Rendering of a Name Yielding a Mnemonic
ACS	Altitude Control System
AM0	Air Mass 0
AM1.5	Air Mass 1.5
ANSI	American National Standards Institute
AOCS	Attitude and Orbit Control System
AOTV	Aeroassisted Orbital Transfer Vehicle
ASAP	Ariane Structure for Auxiliary Payloads
ASAR	Advanced Synthetic Aperture Radar
ASE	Advanced Space Engine
ASLV	Indian launch vehicle
BOL	Beginning Of Life
BOOM	Beginning of Mission
BTU	British Thermal Unit
c-Si	Crystal Silicon
CAST	Chinese Academy of Space Technology (PRC)
CCIR	International Radio Consultative Committee
CDS	Command and Data handling Subsystem
CFRP	Carbon Fiber Reinforced Plastic
CGWIC	China Great Wall Industrial Corporation
CIS	Commonwealth of Independent States
CIS	Copper Indium di Selenide
CLAES	Cryogenic Limb Array Elaton Spectrometer
CMD	Cerium-doped microsheet grade D
CMG	Control Momentum gyros
CMOS	Complementary Metal Oxide Semiconductor
CMZ	Cerium-doped microsheet grade Z
CNES	<i>Centre Nationale d'Etudes Spatiale</i> (France)
COMSAT	Communication Satellite
COTV	Cargo Orbital Transfer Vehicle
CPR	Cardiopulmonary Recussitation
CPU	Central Processing Unit
CSI	Control Structures Interaction
CVD	Chemical Vapor Deposition
CW	Continuous Wave
DC	Development Cost
DC	Direct Current
DCS	Decompression Sickness
DDT&E	Design, Development, Test, and Evaluation
DHL	Overnight delivery company
DIPS	Dynamic Isotope Power System
DNA	Deoxyribonucleic Acid
DOE	Department of Energy (USA)
DPS	Distributed Parameter Systems
EAP	<i>Etage d'Accélération a Poudre</i>
EASE	Experimental Assembly of Structures in EVA
EC	European Community
EDL	Electric Discharge Laser
EEG	Electroencephalogram
ELA	<i>Ensemble de Lancement Ariane</i>
EM	Electromagnetic
EMC	Electromagnetic Compatibility
EMI	Electromagnetic Interference

EMR	Electromagnetic Radiation
EMU	Extravehicular Mobility Unit
EOL	End of Life
EOSAT	Earth Observing Satellite
EOTV	Electric Orbit Transfer Vehicle
EPA	Environmental Protection Agency (USA)
EPC	<i>Etage Principal Cryotechnique</i>
EPS	<i>Etage a Propergols Stockables</i>
ERS	Earth Resources Satellite
ESA	European Space Agency
ETO	Earth to Orbit
ETS	Engineering Test Satellite
EURECA	European Research Carrier
EVA	Extravehicular Activity
FEB	Former Eastern Block
FEL	Free Electron Laser
FET	Field Effect Transistor
FSU	Former Soviet Union
FSW	Chinese Long March piggy back service
GAS CAP	Get Away Special Complex Autonomous Payload
GAS	Get Away Special
GC	Ground Stations Cost
GCR	Galactic Cosmic Radiation
GDP	Gross Domestic Product
GEO	Geostationary Earth Orbit
GM	General Motors
GNC	Guidance, Navigation and Control
GNP	Gross National Product
GPS	Global Positioning Satellites
GRS	Ground Receiving Station
GTO	Geostationary Transfer Orbit
H10	Upper stage of Ariane
HALOE	Halogen Occultation Experiment
HLLV	Heavy Lift Launch Vehicle
HRDI	High Resolution Doppler Imager
HT	High Tension
I/O	Input/Output
IC	Integrated Circuit
ILI	International Lunar Initiative
INMARSAT	International Maritime Satellite
INTELSAT	International Telecommunications Satellite Organization
IOTV	Intra Orbital Transfer Vehicle
IR	Infrared
IRDB	International Resources and Development Bank
IRSU	Insitu/Indigenous Resource Utilization
ISAS	Institute for Space and Astronautical Sciences (Japan)
ISLAMS	Improved Stratospheric And Mesospheric Sounder
ISPO	International Solar Power Organization
ISRO	Indian Space Research Organization
ISRU	Indigenous Space Resources Utilization
ISTP	International Solar Terrestrial Physics
ISU	International Space University
ITU	International Telecommunications Union
IU	Instrument Unit
IUS	Inertial Upper Stage
IVA	Intravehicular Activity
JERS	Japanese Earth Resources Satellite
LANDSAT	Land Satellite
LB	Lunar Bus
LCH4	Liquid Methane
LDC	Less Developed Countries
LDR	Liquid Droplet Radiator
LEO	Low Earth Orbit

LET	Linear Energy Transfer
LEV	Lunar Excursion Vehicle
LH2	Liquid Hydrogen
LLO	Low Lunar Orbit
LLP	Light weight Lattice Panel
LMF	Lunar Manufacturing Facility
LO2	Liquid Oxygen
LOX	Liquid Oxygen
LSS	Large Space Structures
LSSCD	Lunar Storm Shelter Concept Design
LTV	Lunar Transfer Vehicle
MBB	Messerschmidt Bölkow Blohm
MDAC	McDonald Douglas Aircraft Company
METS	Microwave Energy Transmission in Space
MIC	Microwave Integrated Circuit
MIL STD 1553B	Military Standardized data bus architecture
MLI	Multi Layer Insulation
MLS	Microwave Limb Sounder
MMC	Metal Matrix Composite
MMH	Mono-Methyl Hydrazine
MMIC	Monolithic Microwave Integrated Circuits
MON	Mixed Oxides of Nitrogen
MPD	Magneto-Plasma Dynamic
MS	Micro Strip
NAS	National Academy of Science (USA)
NASA	National Aeronautics and Space Administration (USA)
NASDA	National Space Development Agency (Japan)
NASP	National Aerospace Plane
NATO	North Atlantic Treaty Organization
NERVA	Nuclear Engine for Rocket Vehicle Applications
NIR	Near infrared
NLS	National Launch System
NPV	Net Present Value
NRC	National Research Council (USA)
NTM	Non-Terrestrial Materials
OC	Operating Costs
OECD	Organization for Economic Cooperation and Development
OMV	Orbital Maneuvering Vehicle
ORU	Orbital Replaceable Unit
OSC	Orbital Sciences Corporation
OTV	Orbital Transfer Vehicle
P & W	Pratt & Whitney
PAA	Phased Array Antenna
PAM	Payload Assist Module
PCU	Power Conversion Unit
PEL	Public Emergency Limit
PEM	Particle Environment Monitor
P/F	Platform
P/L	Payload
PLSS	Portable Life Support System
PLV	Personnel Launch Vehicle
PM	Personnel Module
POTV	Personnel Orbit Transfer Vehicle
PPU	Power Processing Unit
PRC	People's Republic of China
PV	Photovoltaic
PV	Present Value
QAJ	Quick Attachment Joints
RCS	Reaction Control System
RAPUNZEL	Piggy back System (Russia)
RF	Radio Frequency
RFI	Radio Frequency Interference
RMF	Residual Mode Filters

ROI	Return on Investment
ROM	Reduced Order Models
RPM	Revolutions Per Minute
RTG	Radioisotope Thermal Generator
RW	Reaction Wheel
SA	Solar Array
SAA	South Atlantic Anomaly
SAR	Synthetic Aperture Radar
SDS	Solar Dynamic System
SERI	Solar Energy Research Institute
SFU	Space Flyer Unit
SGD	Space to Ground Demonstration 1
S/L	Satellite
SME	Society of Mechanical Engineers
SOLSTICE	Solar/Stellar Irradiance Comparison
SPAS	Shuttle Pallet Satellite
SPDE	Space Power Demonstrator engine
SPELDA	<i>Structure Porteuse Externe Lancement Double Ariane</i>
SPS	Solar Power Satellite
SQ	Space Qualified
SRB	Solid Rocket Booster
SRM	Solid Rocket Motor
SSA	Space Suit Assembly
SSF	Space Station Freedom
SSLV	Standard Small Launch Vehicle
SSME	Space Shuttle Main Engine
SSO	Sun Synchronous Orbit
SSPP	Space Solar Power Program
SSTO	Single Stage to Orbit
STAR	Commercial solid upper stage engine
STPL	Short Term Public Limit
STS	Space Transportation System
SU	Space Unqualified
SUSIM	Solar Ultraviolet Spectral Irradiance Monitor
TBC	To Be Confirmed
TBD	To Be Defined
TCS	Thermal Control System
TDRSS	Tracking and Data Relay Satellite Systems
TELEC	Thermoelectric laser energy converter
TFU	Theoretical First Unit cost
TOS	Commercial upper stage
TPS	Thermal Protection System
TPV	Thermophotovoltaic
TSTO	Two Stage to Orbit
TT&C	Telemetry, Telecommand and Control System
TTL	Transistor Transistor Logic
TV	Television
UARS	Upper Atmosphere Research Satellite
UN	United Nations
US	United States
USA	United States of America
USAF	United States Air Force
USS	Ultra Short Spelda
USSR	Union of Soviet Socialist Republics
VEB	Vehicle Equipment Bay
VOC	Value of combination
VSWR	Voltage Standing Wave Ratio
WDE	Wheel Drive Electronics
WINDII	Wind Imaging Interferometer
WSF	Wake Shield Field
XLR-132	Experimental Liquid Rocket -132

Executive Summary

I. Problem Statement

A little over a decade ago, the concept of space solar power for Earth effectively died after a National Academy of Sciences critique of the landmark 20 Million US\$ NASA/DOE study of a Solar Power Satellite (SPS) reference system recommended against implementation due to high costs and uncertainties. In the present work we do not set out to resurrect the five gigawatt-level point design of the NASA/DOE study, but instead attempt to reincarnate the "spirit" of space solar power into a new and improved body.

The concept of space solar power as envisioned by Peter Glaser in 1968 was to provide for the Earth's energy needs through the use of satellites in geosynchronous orbit. These satellites would be equipped with solar arrays to capture the Sun's energy and transmitters to beam this energy down to the Earth in the form of microwaves. The rationale for undertaking this formidable program was to provide a solution to an even greater problem: namely, the coupling of the projected increase in the world's energy demand with the destructive effects of their continued use, on the global environment. The energy demand increase seems unavoidable: the developed world can only marginally reduce its actual usage rate by conservation, if it is to maintain present living standards, and the developing world will require a large increase in its energy consumption if it is ever to achieve industrialization and a better life. This dilemma is compounded by two factors: the vast majority of the projected doubling of the world's population is expected to take place in these developing countries, effectively increasing demand; and the reserves of these nonrenewable fossil fuels are steadily decreasing, absolutely limiting supply. Thus the energy problem can be characterized by both global and local resource availability, environmental effects, and cost impacts of energy allocation.

It would be unethical for the developed world to place restrictions on increased energy usage by developing countries, particularly considering the fact that to date, the "developed" countries are responsible for the largest part of the damage inflicted upon the global environment. It is also irrational to expect the developing countries themselves to forego their own development for the sake of the preservation of the world's environment. Hence, if their inevitable development is achieved though the use of fossil fuels, the entire global environment will suffer. Consequently it is in the developed countries' own best interests to create new environmentally safe energy sources capable of meeting future global needs.

Therefore what is desperately needed is an alternative energy source that is both cost-effective and "clean." Although there are several possible solutions, one which has tremendous potential to serve as the energy source of the future is space solar power. It is effectively inexhaustible, relying as it does on the Sun's energy; it has the capability to deliver energy directly to the users who need it most; also, unlike terrestrial solar power, which is limited by nighttime, weather, land use, and storage considerations, space solar power has the potential to deliver energy continuously. What is of paramount importance is the projection that space solar power minimally affects the environment, especially with regard to the problems of global warming and pollution. If this hypothesis is confirmed and the effects are indeed minimal, then space solar power would become increasingly attractive in the future. We feel that both its environmental benefits and potential side-effects deserve full and early investigation.

But before continuing, we should explain who "we" are. We are 97 students from 22 countries who attended the fifth International Space University (ISU) summer session, held in Kitakyushu, Japan, from June 16th to August 26th, 1992, in part to study space solar power. We were assisted by a diverse faculty having both general and solar-power-specific space expertise. ISU is an emerging multidisciplinary institution attended not only by engineers and scientists, but also by architects, business people, medical doctors, lawyers, and a variety of professionals brought together by their common interest in space development. Since one of the founding philosophies of ISU is to promote international endeavors into space, our specified task has been to serve as analysts for a hypothetical client: an international consortium of governments and/or industries interested in space solar power. Specifically, our assignment has been to

"produce an overall development program plan for the demonstration, testing and early commercial development of space beamed power systems up to and including

initial space to ground tests . . . the program plan will include, but will not be limited to, a presentation of two distinct design examples to demonstrate to the client what systems are possible and useful during this phase of activity . . . *Design Example #1* should be a space to space power demonstration/application (which will convince decision makers to fund the next level) which can be completed within 5 years from now with a total budget not to exceed \$80 Million (10^{10} yen) . . . *Design Example #2* should be a space to ground demonstration or application which can be completed within 10 years from now with the total budget not to exceed \$800M (10^{11} yen) . . . The client has made it clear that it is biased in favor of early and low-cost demonstrations.”

Also, in the longer term, we were asked to consider in general the five following long-term questions concerning space to ground power systems:

- “Q1. Under what conditions will such systems be economically viable?
- Q2. What must be learned before such systems can be created?
- Q3. What investigations and experiments should be undertaken to accomplish (Q2)
- Q4. What are the priorities for (Q3) above?
- Q5. Are there any “high-leverage” issues that would greatly impact (Q1)?”

In order to best answer this wide array of tasks, we divided ourselves, mainly but not entirely by discipline, into 10 task groups:

- Assumptions, Intentions, and External Relations
- Scheduling
- Legal and International Relations
- Business Planning
- Environment and Safety
- Space Transportation
- Manufacturing, Construction, and Operations
- Spacecraft
- Power Collection, Conversion and Distribution
- Technical Trade Identification

In addition, an Animation Group was created to produce a video presentation (which can be obtained from ISU Headquarters). Formation of a Report Group and a weekly-rotating Coordinating Interface Group, both consisting of members of each of the ten main task groups, was needed to put together the report and coordinate the groups’ work, respectively. Also, so-called “tiger teams,” represented by many but not necessarily all of the groups, were created in order to address the specific design examples.

What is new in our contribution? We do not presume to outdo the advanced scientific and engineering work undertaken by industry and agency laboratories throughout the world. What we have attempted to offer is a structured outlook at the circumstances under which space solar power for the Earth and elsewhere would be viable, as well as a program to advance towards this goal, beginning with early, practical, well-defined demonstrations. Our strength comes from the very characteristics that make ISU unique: our multidisciplinary and multinational composition. The community undertaking the effort of research and development in space solar power is largely made up of scientists and engineers, so a fresh look at problems from different viewpoints, including policy and business matters, may give a new perspective on what are the critical issues governing implementation of their scientific and engineering efforts. Similarly, the approach resulting from our wide mixture of nationalities is bound to be sensitive to the needs of international cooperation, as will surely be required by the scope and size of future worldwide space solar power. New, more active roles for developing countries, and changing relations between established economic powers thus come to shape the program herein proposed, and reflect the trends of the coming global era in which solar power from space could become a reality.

II. Space Solar Power Program Development Plan

In this section we will present a system-level view of the space solar power program, the technology development plan, the overall development plan, and the overall program schedule.

From a *systems engineering* viewpoint, we examine the flow from requirements to design options and choices in the presence of constraints. The top-level requirements include technical feasibility, business viability and environmental, safety, political, and social acceptability and have different degrees of impact on the program. The market is a major driver, followed by finance and cost competitiveness. Also, social and political constraints decisively affect the flow and the trade-offs to be made. The following figure shows how certain requirements drive other requirements and design choices, under the influence of constraints such as state of technology and regulatory issues.

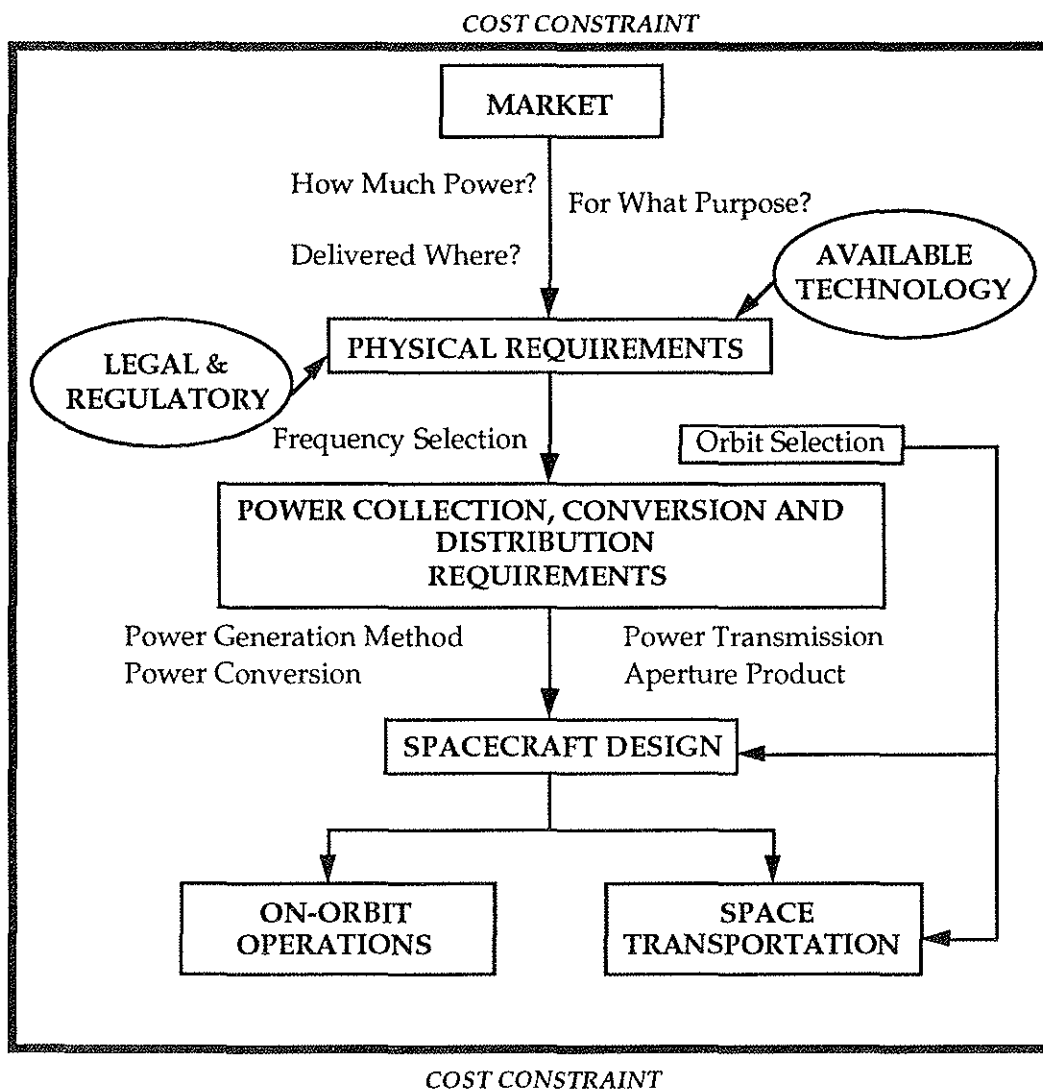

Figure 1 Driving Requirements for Space Solar Power Program

In this context, it must be noted that while technological developments are of primary importance to the viability and success of space solar power, many of the fundamental problems to be solved have been widely recognized to be of a social, political and economic nature. The "non-technical" requirements appear to be the more stringent .

Among the most important design options are those for power conversion (photovoltaic or solar dynamic power) and transmission (microwave or laser beaming). A discussion of these issues is presented in section IV.

The *technology development plan* presented in this section is derived from an examination of the program requirements, technology options and schedule. This plan is a guide to the development of technologies that support the necessary projects and demonstrations leading to a fully operational space solar power program.

High priority issues and timing issues have been identified for each discipline involved in the program as a result of the present work. Though the complete study addresses three levels of priority and three timeline levels (short, mid and long term), only the high priority issues and the short term schedule (i.e. next 5 years) are included in the present Executive Summary (see Table 1).

From this technology development plan, it can be seen that significant efforts will be required in order to make the program commercially and socially acceptable. In particular, substantial reductions in launching costs will be needed to initiate the full-scale project.

The *overall development plan* as envisioned now consists of five distinct steps or projects intended to demonstrate technologies, address crucial development issues, and progressively evolve towards full commercial implementation of space solar power. Each project must serve to support the next project or step in the terraced plan, and aid in making cost estimates for the following phase. In addition, long-term research and issues must be conducted in parallel in the disciplines of physical and life sciences, among others, in order to support the final goal.

Each of the projects within the plan represents a step towards the ultimate goal of large scale power production. A major critical challenge for this phased approach is to envisage significant and independent goals for each of the steps, that are also to be carried in a timely manner. The program's evolution can be portrayed as a series of steps, the last of which is the operational space solar power program system (See Figure 2), and which is not tied to a pre-specified "goal date". The representation of the development plan as a terrace is attributed to Peter Glaser who described terracing as "small projects that have progressive and continuing benefits". Thus the emphasis is on "program" rather than "project".

Also, this overall program plan acknowledges the existence of other major independent space programs and plans input from them at two major "decision-to-proceed" points in time, located between the near-term and mid-term programs, and between the mid-term and far-term programs. It is foreseen that the evolution and future of the program will ultimately be linked to general worldwide trends in space development, even if its final goal addresses the fundamental and earthly future energy needs of our planet.

Table 1 Priority and timing issues

	Highest priority issues	Short-term issues (5 years)
Space transportation	reduction of Earth-to-orbit (ETO) launch costs	improvement in availability and operations costs for current vehicles preliminary studies for future space transportation vehicles
Spacecraft	attitude and orbit control and vibration control of large space structures (LSS) efficient radiator systems	structural and electrical interfaces for the space-to space antenna and rectenna. development of a deployable phased array structure
Power collection conversion and distribution	development of more efficient power conversion systems	development of high accuracy phase shifter and solid state power amplifier development of both 2.45 and 35 GHz phased arrays
Environment, physical, and life sciences	determination of beam effects on biota and the atmosphere on Earth	determination of effects of beam on electronics and astronomic observations determination of the risks to astronauts performing experiments
Social and Political	creation of an international group to manage a space solar power project insure security of satellite and beam	creation of an international organization and obtain signatory contributions initiate lobbying at International Telecommunications Union (ITU) for frequency allocation
Manufacturing and assembly	development of advanced assembly techniques in robotics and Extra Vehicular Activity (EVA)	initiate lab studies for in-situ resource utilization (ISRU) development of improved assembly techniques using Space Station Freedom and/or Mir experience
Business and other	achieve business feasibility for program search for long-term funding achieve scientific acceptance public awareness	ensure credibility of organization to perform programs promotion of the space solar power concept raise funding for short and mid term needs gather a core of interested scientist and engineers educate people about energy demand, pollution and alternative source of energy

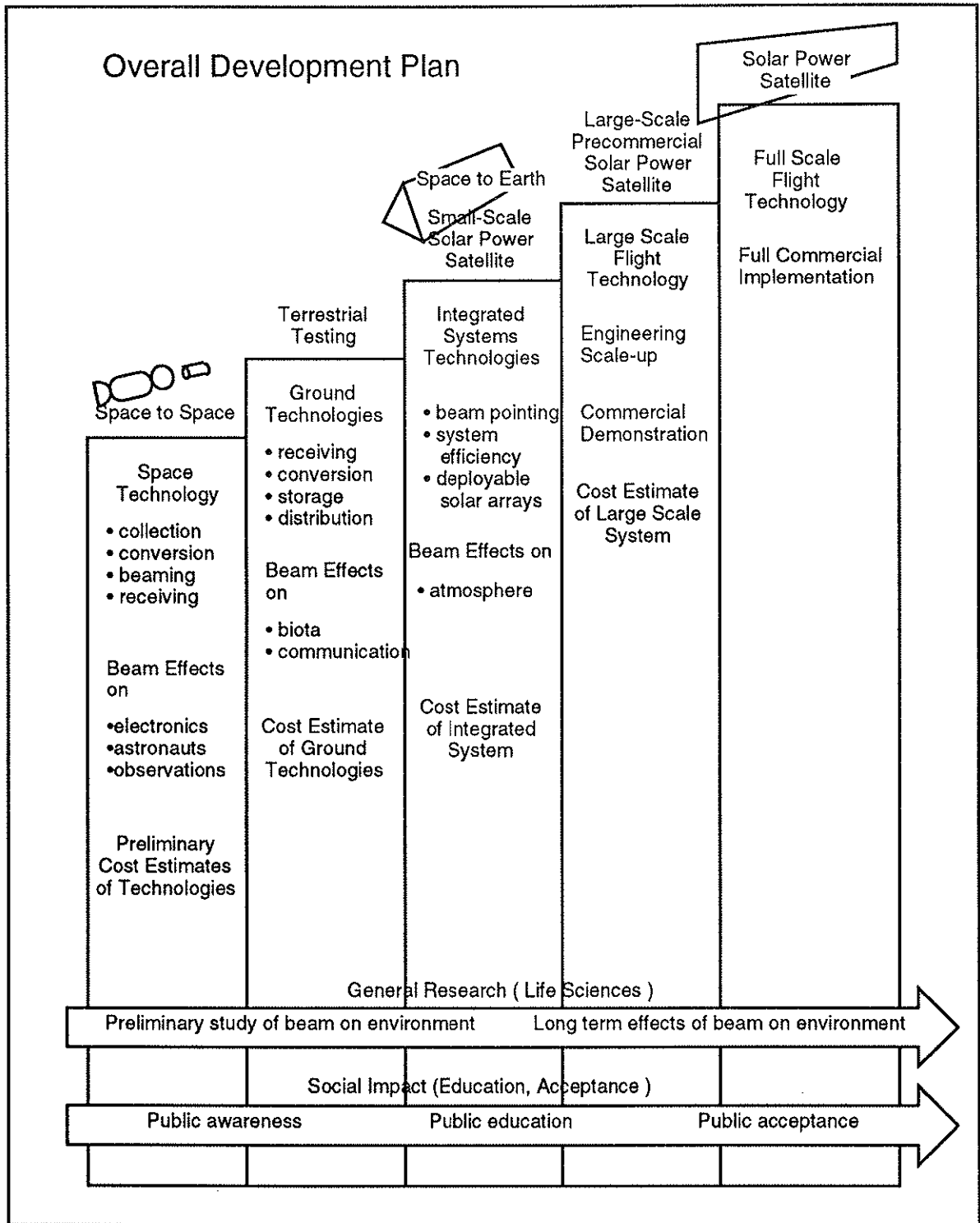

Figure 2 Overall Development Plan

The *overall schedule* for the Solar Space Power Program is shown in Figure 3. The program is somewhat arbitrarily scheduled to start in September 1992. In principle the schedule is separated into four major tasklines :

- Business and Management Aspects
- Political and Legal Aspects
- Environmental and Safety Aspects
- Technological Aspects

The rectangular boxes represent the several subprograms. The rounded boxes represent major milestones in the program. The Technology Aspects taskline is further separated into other tasklines, the most important of which is the Spacecraft Development taskline. This line includes several demonstration programs that have been proposed in our work and their launch dates, which represent phases in the overall development directly correlated to the tasks in the overall schedule.

Because of the long duration of the whole space solar power program, it is difficult to schedule the duration of the long-term phases. Therefore the near-term phases are better defined and have a more reliable basis.

The schedule represents a best-case scenario. It assumes that technological progress will proceed at a reasonable pace, and that the major financial and political problems involved can be solved.

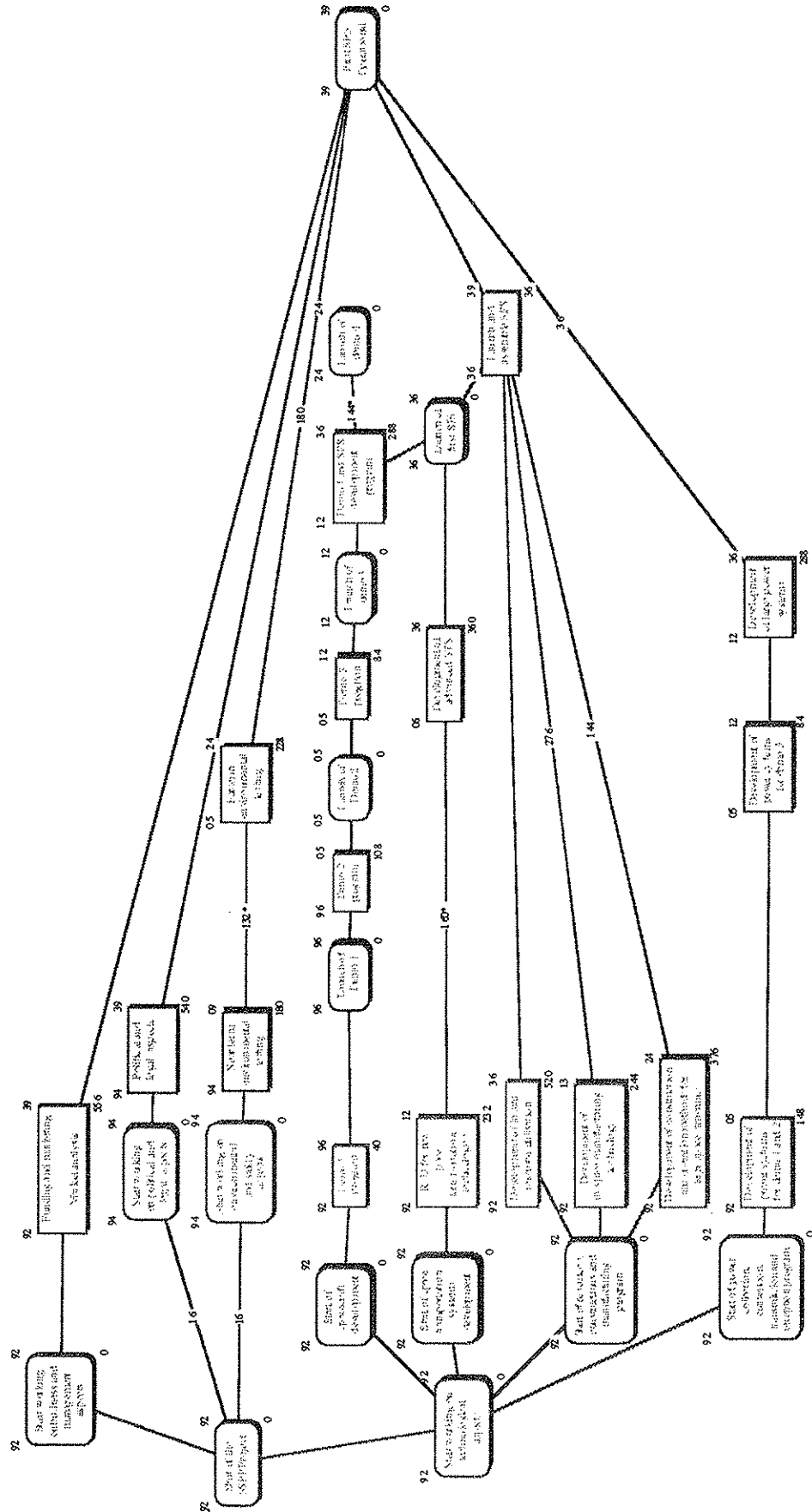

Figure 3 Overall Space Solar Power Program Task Schedule

III. Program Framework: Business Opportunities, Environmental Concerns & Organizational Issues

The program herein proposed encompasses a variety of important non-engineering issues, ranging from market/business opportunities to the requirements and constraints that are going to shape its development, be they environmental concerns or political, legal and organizational matters. It is important to recognize that this combined framework may dominate the evolution of the proposed program more profoundly than technology developments and engineering needs. We now briefly review our approach and more important results concerning this "non-engineering" framework.

We have identified markets for near-term (around 2000 - 2020 time frame), mid term (2020 - 2040) and long term (2040 - 2100), and have found that the main segmentation will be between space-based and earth-based markets.

In the near term there does not appear to be a viable market for space-based beamed power to serve existing communication satellites, mainly due to the state of laser technology and the extraordinary levels of reliability demanded by a risk-averse space industry. The mid-term picture is better, because in this period it is thought that the power beaming concept might be well-proven enough that clients would design their spacecraft with the intent of receiving power from an outside source. Also, power servicing during eclipse periods for satellites and platforms could eliminate the need for heavy batteries, and result in mass or payload savings. The potential market value of eclipse servicing is fairly high, but a high level of market penetration would be necessary for profitability. Were this and related markets (such as beaming from space to future space stations or microgravity processing space facilities) to be successful, very large construction and development costs could be offset by revenues, generating multi-billion dollar profit over a 20-year period.

Four earth-based market segments have been identified:

- i) remote locations with a developed energy demand,
- ii) locations that use little power now and that are not connected to any grid, like villages in developing nations,
- iii) power relay from energy-rich areas on earth to an area with high power demands,
- iv) large scale electricity grids.

The first category includes towns or villages in Alaska or Siberia, research centers in Antarctica and small islands or groups of islands. Reasonable price levels may be in the range \$0.20 - 0.60 /kWh (with higher prices for polar regions). This market segment will be relatively stable in the future.

Remote locations with a developing energy demand are mainly found in developing countries at low latitudes. Providing even small amounts of energy to these locations gives direct and substantial benefits to the population and the environment. A problem is the lack of hard currency in these locations to pay for this energy, so it is proposed that alternative financing mechanisms be found, such as reallocation of aid funds from energy generation to provision of electricity. Much of the growth in world energy demand is predicted in these regions, so this segment is expected to grow in the near term, and stabilize in the mid term.

Relaying power from one location on earth to another is another segment. As long as there exist locations with large natural energy resources but with a low local demand, the energy could be generated and transported to high demand areas. The users of relayed power would be the electricity companies operating the power grid. For the near term, these markets are roughly located in North America, Europe and Japan, but will start to spread in the developing world as well.

Large grid operating companies are the major customers, especially in the long term. In the near term, delivering additional power during peak load times (about 6 hours a day) is interesting. For the long term, power delivery both for base and peak load seems sensible. High reliability will be required in this segment.

A financial plan for ground to space solar power based on the phased approach explained in the previous section, has been studied. The initial (two) development steps would not generate revenues, but should give credibility for the space solar power organization. Subsequent commercial enterprises could generate yearly profits of up to 0.2, 100, and 2000 M\$ / year, and a partial privatization of this organization could be arranged after the success of the second of these ventures. Throughout the length of this plan the space solar power organization would evolve from being mainly publicly

funded towards increasing commercialization. Operation costs could be privatized first, and launch and manufacturing costs next.

While several of the explored markets are encouraging, it is important to acknowledge that future space solar power businesses entail major financial risks: high production costs, unproven technologies, uncertainties that may cause project delays and large cost overruns, unassured public support and funding, and component development delays. Clearly, creating and maintaining financial investors' confidence should be seriously addressed and monitored throughout program development.

Major constraints for technology tradeoffs will arise from environmental and safety considerations. We enumerate the major concerns:

- Atmospheric effects due to energy dissipation (such as heating and scattering), mainly for 2.45 GHz microwaves, as 35 GHz microwaves produce much less ionospheric heating.
- Limitation of power densities of 2.45 GHz microwaves and visible lasers to prevent biological injuries. Further investigation is needed for 35 GHz microwaves.
- Impact of large number of launches: pollution, perturbations on the ionosphere and magnetosphere resulting in communication interference, among others.
- Potential health impact of extended exposure to space or lunar environment. Needs for new Extra-Vehicular Activity (EVA) and Intra-Vehicular Activity (IVA) life-support structures and new EVA suit designs.
- Rectenna construction and operation: social and environmental issues.

Clearly, basic research experiments will have to be designed and implemented in order to give a satisfactory answer to some of these concerns.

Finally, the importance of legal, political and regulatory issues for space solar power development must not be underestimated. In particular, the space solar power program, being international in character, benefits from the recent major changes in the international political regime. The renewed focus on economic rather than military issues offers more opportunities for meaningful international cooperation.

Nevertheless, especially at the initial stages of the program, national interests should be carefully taken into consideration. Also, due to concerns of international industrial competitiveness, technology transfer remains a significant issue. In order to maximize the practical chances of success of the program, technology transfer will be minimized to a "need to know" basis, and technical interfaces across different participating countries will be kept as simple as possible.

The proposed space solar power organization intends to be an international, flexible entity which can evolve as the program progresses, and it is intended to concentrate on achieving commercial rather than political objectives. Full voting representation for all contributing governments and private entities would be achieved at a future Assembly of Signatories, that would set general policy. This policy would be implemented, and the appropriate executive body appointed, through a Board of Governors, where representation would be proportional to members' contribution.

Legal implications of the implementation of space solar power systems will include: the compatibility between the principle of non appropriation of outer space and the installation of lunar bases to manufacture the satellites, the utilization of the Moon's resources, the use of power beams, the occupation of geostationary orbit slots, and the need to guarantee that the power systems will be used solely for peaceful purposes. As to the problem of orbit and frequency allocation, we consider that the International Telecommunications' Union (ITU) has competence in this matter. One point of interest is that allocation of 35 GHz may be easier than for 2.45 GHz, due to the proliferation of mobile phone users at frequencies in the vicinity of the latter. Our appreciation is that a high-level political decision will be necessary for system operation due to the fact that there exists a keen competition with other services such as telecommunications for both frequency and orbit allocation problems. Finally, since the setup of the system implies a number of risks (collision, environmental damages, etc.) and it remains very difficult to include some categories of damages in the existing rules of international law relating to responsibility, there is a clear need for the elaboration of new international space legislation and, in particular, an agreement on exposure standards for microwave and laser beams.

IV. Program Engineering: Space Power & Infrastructure

Power

A space solar power system can consist of four subsystems: collection, conversion, transmission and reception. Current plans call for collection subsystems that are either photovoltaic or solar dynamic. Similarly, planned conversion, transmission, and reception subsystems for space solar power tend to employ either microwaves or lasers. In both cases the major trade-off to consider is power output vs. mass. Recent technology developments in space solar power systems have focused on improving these subsystems by changing the method of incorporating microwaves and lasers into the total space solar power system. New studies integrate sub-system level components into one unit, such as the combination of a transmitter and a solar cell. The advantages of integrated systems for space systems applications include: reductions in mass, size, and thermal losses; an increase in efficiency; and most importantly, a significant decrease in the size of solar power satellites.

Traditionally, microwave beaming at 2.45 GHz has been the power transmission frequency chosen for space solar power systems; this frequency was extensively studied as part of the NASA/DOE SPS reference system. Consequently, power beaming technology is most developed at 2.45 GHz. However, it may be wise to consider space solar power transmission at 35 GHz instead. Aside from the non-technical advantages discussed earlier, beaming at 35 GHz allows the delivery of power to a rectenna approximately 200 times smaller in area than the one required by 2.45 GHz beaming, assuming the same power level, antenna size, and transmitting distance (alternatively, one can reduce the size of the antenna, increase the distance of transmission, or any combination thereof). Also, beaming at 35 GHz only heats the ionosphere to 1/200th the level of 2.45 GHz beaming. Therefore, by using 35 GHz instead, one can transmit with power densities substantially greater than the 23 mW/cm² limit on 2.45 GHz beaming used by the NASA/DOE study. Of course, there is the problem of increased atmospheric attenuation at higher frequencies, which is indeed quite serious since not just precipitation but even the mere presence of cumulus clouds will attenuate 35 GHz transmissions. But for space to space applications, for which there are no atmospheric losses, higher frequencies such as 35 GHz are preferable.

Therefore, we recommend research and development target improvements at 35 GHz beaming technology, and in particular the development of high-power 35 GHz phased array transmitters. Phased array transmitters, which utilize electronic as opposed to mechanical "steering," are superior to ordinary reflector transmitters because of new advances in solid state electronic amplifiers which permit the use of high efficiency, low mass and high power antennas for high precision beam pointing and control. Thus, we strongly suggest the space-based testing of phased array antennas and the ground-based fabrication of larger, more powerful phased arrays, especially at 35 GHz. For this reason, three of the design examples that we have considered in depth incorporate phased arrays, and two of these three operate at 35 GHz.

In principle, lasers are an even more attractive technology than 35 GHz for power beaming. The divergence of laser beams is minimal, only about a few arc seconds, and theoretically requires much smaller transmitters and receivers, allowing for greater power densities. However, the efficiency of state of the art laser technology is actually quite low. Additionally, the atmospheric attenuation for available laser wavelengths causes a problem for space to earth power transmission. Also, the mass and volume of available lasers need to be reduced by at least two orders of magnitude before this beaming technology can become viable for space solar power. However, when these reductions do occur, the ramifications for space solar power will be immense. Hence we have identified the advent of affordable laser technology as one of the "high leverage" issues raised in question Q5 (see Section I), and it will be more fully discussed in Section VI.

Presently, silicon photovoltaic cells are widely used to collect and convert solar energy in orbit with about 15% efficiency. These cells will probably be replaced soon for certain missions by more efficient (close to theoretical limit of 30%) GaAs or InP cells. However, it is our view that Solar Dynamic Systems (SDS) hold considerable promise for the future of power generation, offering potentially higher overall efficiencies in the range of 20-30% at reduced mass and cost when compared to photovoltaic systems. But before SDS can be incorporated into a space solar power system, they need to be space-qualified. In order to solve this problem, we recommend the launch of a solar dynamic power demonstration mission. Towards this end, the successful proposed installation

of an SDS on Space Station Freedom would represent a major milestone for space-based power generation. Other novel types of power collection offering competitive efficiencies include thermoelectric and thermophotovoltaic systems. Development of new radiators, such as the liquid droplet radiator which can be up to 10 times lighter than conventional radiators, will also increase the overall competitiveness of SDS.

Transportation

Space transportation is usually the single greatest expense of a space project. Considering that about 25 to 40% of the cost for a mission that lasts several years is spent on the provision of a service that may take as little as ten minutes, it is clear that special attention must be given to this topic when considering a project on the scale of space solar power. The high cost of space transportation has been a stumbling block for previous studies of space solar power, such as the NASA/DOE study, and those studies have in fact been overly optimistic about future launch costs.

Space transportation will affect the development of space solar power in both the demonstration and final system phase. Early demonstrations can easily be delivered to orbit by current launchers, and some may in fact be launched via "piggyback" options. One such scenario is the proposed Arecibo Earth to space US \$5 Million design example, which plans to make use of the Ariane Structure for Auxiliary Payloads (ASAP) ring on Ariane 4. On the other hand, demonstrations scheduled for the next ten to twenty years which are larger in size— 1 MW or more— would profit from the use of systems presently under development or updated versions of current launchers.

The long-term space transportation needs of a large space solar power system have been considered. A basic scenario has been presented which assumes that different types of payloads will have different criteria for selecting launch services, depending on how they prioritize such factors as cost, reliability, availability and resiliency. Hence we conclude that a system of solar power satellites is likely to require a fleet consisting of at least three classes of vehicles: personnel, priority cargo, and bulk cargo. For Earth to orbit delivery: the personnel transports developed will be highly reliable Single-Stage-To-Orbit vehicles; the priority cargo vehicles will be Heavy Lift Launch Vehicles; and the extremely low cost bulk cargo vehicles may be either electrical mass drivers or chemical accelerators. For inter-orbit transfers, the personnel and priority cargo transports developed may be LOX/LH₂-fueled Orbital Transfer Vehicles (OTV). Bulk will likely be handled by low thrust electrical propulsion OTV. Since certain solar power satellite construction scenarios involve lunar resource utilization, lunar transports are also considered. Because most of the technology is now available, a cislunar transportation system based on chemical propulsion could be realized in less than a decade. However, in the future it may be beneficial to make use of electric propulsion, nuclear thermal propulsion, and especially electromagnetic mass drivers.

The central question concerning future space transportation, though, is not its type but its cost. Though difficult to predict, an overall one order of magnitude cost reductions seems reasonable, particularly when taking into account the effects of scale. On the order of 20,000 tonnes payload mass have to be launched for every 1 GW of power delivered to Earth. This is hundreds of times more than the current global annual launch rate. Therefore significant price reduction can be expected as the launch rate increases. We believe that the reduction in transportation costs that a space solar power program would bring about beneficial side-effects to all global space-related activities.

Lastly, we recognize the importance of developing alternatives to traditional chemical propulsion. One such alternative that may be of particular relevance to space solar power is the development of electric propulsion, which is in fact one of the "high leverage" issues discussed in Section I. Not only can electric propulsion reduce the transportation cost of space solar power satellites (as in the 1 MW class design example) but it represents a possible market for beamed power. Electric propulsion Orbital Transfer Vehicles are potentially made more effective by using beamed power. Utilization of a remote power source would increase the mass efficiency of electric propulsion relative to competing technologies and would significantly reduce vehicle trip times compared to standard electric vehicles. Consequently, it might be worthwhile to attempt a power beaming demonstration to an electric propulsion vehicle as soon as this is technologically feasible.

Manufacturing, Construction, & Operations

The most daunting technical obstacle facing space solar power will probably be the assembly and maintenance of the large space structures which they require. We found that even in a best case scenario, where the satellite is transmitting 500 MW and is converting solar energy to electricity at an efficiency of 60%, the satellite will still be well over 100 times the size and 10 times the mass of

Space Station Freedom. Freedom, which is planned to be the largest object yet put in orbit, will take NASA several years to construct. After analyzing deployable and erectable technologies with regard to large space structures, we conclude that the assembly and maintenance of solar power satellites will be of sufficient complexity to absolutely require an assembly and maintenance oriented demonstration before any system of solar power satellites can be installed. The primary purpose of this last prototype would be to show not only the ability to build the solar power satellite, but also the related but yet quite different ability to maintain it, for a period of about 5 years (based upon a desired 30-year satellite lifetime). In addition, many experiments of deployable and erectable technologies need to be performed. These can range from small scale demonstrations, like the proposed Earth to space design example that plans to use an inflatable rectenna, to larger scale experiments such as the proposed 1 MW design example, which requires manned assembly, and SPS-2000, which the Institute for Space and Astronautical Science (ISAS) of Japan plans to assemble telerobotically.

Using the figure of 20,000 tonnes per GW for solar power satellite mentioned earlier, this means that one solar power satellite will have a mass of 100,000 tonnes. To put this truly tremendous amount of material into perspective, one has to realize that since the launch of Sputnik 1 in 1957, only 30,000 tonnes of payload have been placed in orbit. Also consider that if a few solar power satellites are constructed simultaneously, then both global launch rates need to increase *and* launch costs need to decrease by at least two orders of magnitude. Furthermore, it will have to be shown that the environmental effects of this greatly increased launch rate are minimal. Because of these assorted potential technical, financial, and environmental "showstoppers" to the building of large solar power satellites with only terrestrial materials, the use of nonterrestrial resources for space solar power has been seriously considered.

Contemporaneous to the NASA/DOE studies, Gerard K. O'Neill, to whom this report is dedicated, first proposed the use of lunar materials for the construction of solar power satellites. O'Neill argued that the raw materials needed for construction of these satellites could be delivered to GEO from the lunar surface at one-twentieth the transport cost of their delivery from the Earth. This argument is based on both the Moon's substantially lower gravity well and its lack of an atmosphere, which allows the use of electromagnetic launchers called mass drivers, whose viability O'Neill also helped demonstrate. This argument, though, overlooks the problem of establishing the necessary cislunar infrastructure and the required orbital manufacturing facilities. But after examining lunar resources, and comparing them to other nonterrestrial resource options like asteroidal materials and such objects as Shuttle External Tanks and Energia Cores, we conclude that the Moon is of particular significance to space solar power and is in fact another "high leverage" issue (see Section I).

The establishment of a lunar base constitutes a high-leverage issue because a lunar base represents not only a future supply of resources for satellite construction, but also a potential market for beamed power. This concept is actually the synthesis of two of O'Neill's ideas: lunar-derived solar power satellites and "bootstrapping." Space solar power systems can benefit from "bootstrapping" by initially providing beamed power to a lunar base, which in turn could provide the system with the materials needed to build more solar power satellites. This power could be implemented in a staged way by first providing kilowatts of energy to a lunar rover from lunar orbit, and subsequently providing up to the approximately 1 MW required by a manned lunar base. A preliminary analysis of a lunar rover demonstration suggests that it might be feasible for approximately US \$1 Billion. Considering the dearth of near-term Earth-based markets, beaming power to the lunar surface may be the best way to convincingly demonstrate space solar power while simultaneously enhancing its long-term economic viability

V. Program Design Examples

Space to Space

Part of our assignment was to investigate a space to space demonstration that could be completed within five years and cost less than US \$80 Million. The near-term demonstration we propose is to beam microwave power from the Mir space station to the unmanned servicing spacecraft Progress. Keeping logistics as its primary mission, Progress will carry the hardware for the beaming experiment (phased array antenna, rectenna, structures, control equipment, etc.) to the Mir space station. While Progress is docked to Mir, the rectenna will be deployed automatically and the antenna will be installed on Mir by a cosmonaut EVA. The beaming experiment will then be carried out after separation of Progress from Mir (see Figure 4, located at the end of Section VI).

The mission will cover a variety of technical and scientific objectives such as demonstrating the functionality of a phased array in space, target acquisition, and beam control. This will be an important step towards possible larger scale application of space solar power systems. Beaming power to Progress could demonstrate the feasibility of a future free-flying high quality microgravity laboratory without solar arrays in the vicinity of a space station. Finally the associated plasma diagnostics could give important scientific information on plasma composition, plasma energy dispersion, plasma waves, and microwave-plasma interactions.

This design example proposes an antenna and rectenna size both equal to 2m x 2m, a beaming distance of about 80 m, and a frequency of 2.45 GHz. With this configuration the overall DC to DC transmission efficiency would be better than 3.7 %, with the antenna transmitting 5 kW and the rectenna receiving 186 W of usable power on the Progress vehicle. Scheduling and costing analysis show that the demonstration project is feasible within 3 years and a total budget of approximately US \$78M.

Projects like this are extremely useful to a general program for space solar power, because they produce valuable data at reasonable costs. Other space to space examples that we considered, though not to the same level of detail, included a Space Station Freedom to Space Shuttle demonstration, which would be of particular use in ascertaining the difficulty of maintaining beam control on large space structures, and a Mir to Shuttle demonstration, which, aside from its technical worth, could be of great public relations value.

Space to Earth

We were also assigned the task of investigating a space to Earth demonstration, achievable in ten years, and budgeted for no more than US \$800 Million. We decided that this second design example should be a demonstration of the ability to provide power from space to remote sites on Earth. Specifically, the concept originated as a plan to provide power to remote scientific research sites in Antarctica. The current cost of power for these sites is higher here than for anywhere else on Earth since fairly inefficient diesel generators are used which require fuel flown in by cargo aircraft at great expense. Non-financial considerations of this mission include measuring the environmental impact of small-scale space solar power with scientific instruments already in place in Antarctica and with Earth Observing Satellites that monitor atmospheric conditions over Antarctica. Since there is already a basis for international cooperation, a need for an environmentally more benign energy source, and a moderate power demand which might be economically achievable by space solar power in the foreseeable future, this mid-term project seemed reasonable to undertake.

The time and cost constraints are major drivers of the satellite design. The relatively short time frame precludes the inclusion of revolutionary technological breakthroughs into the design of the satellite. In addition, the cost allocation quickly leads to the conclusion that a simple and straightforward system shall be built for the baseline system. This means one automatic satellite of limited size, deployment by a single launcher (no manned or robotic assembly in space), and placement into low Earth orbit for purposes of power maximization. The frequency of 35 GHz was chosen instead of 2.45 GHz for reasons of power maximization as well.

The envisaged baseline system includes one 10 ton satellite deployed in a 1000 km, sun-synchronous orbit, with a period of 6h-18h local hours, beaming over a 1 km² rectenna. As can be seen in Figure 5, the satellite makes use of a foldable 1000 m² solar array and a 100 m² phased array antenna operating at 35 GHz. A 35 GHz phased array of this size does not yet exist and would require

substantial development in the next few years, but we feel that this development is warranted given the possible benefits of 35 GHz and phased array technologies to space solar power. The satellite can also carry scientific payload as warranted. This system transmits 150 kW and can supply between 30 kW and 60 kW on the ground. However, the extremely low power flux density, which is less than one-thousandth the activation energy of the rectenna, requires the use of concentrating tracking dishes prior to rectification on the ground. But these concentrators are fixed and limit the time the rectenna can receive energy to less than 6 seconds. If a tracking system is installed on the ground to circumvent this problem, not only is the need for a phased array antenna eliminated, but more power will be needed on ground to perform satellite tracking than can be delivered to the satellite. This limits the purpose of the demonstration to technological and scientific purposes only, and at US \$800 Million it becomes a very expensive research tool, which actually doesn't even perform very much science since by atmospheric standards 150 kW is a paltry amount of power. Therefore the idea of sending this little power at so much cost seems seriously flawed.

More specifically, our analysis revealed that the mission concept of transmitting space solar power to Antarctica is also problematic. We find that even in an absolute best case scenario, where the amount and price of kilowatt-hours are maximized, only on the order of a few hundred million dollars can be collected from a single base over a ten year period, even though the cost of building and launching such a system will be on the order of a few billions of dollars. Therefore, we strongly recommend against a US \$800 Million demonstration to beam power to Antarctica, since all that will be demonstrated is the ability to eventually lose billions of dollars.

Furthermore, we also suggest that a space to Earth demonstration at the level of US \$800 Million not be attempted at all, since the low power densities extremely limit the scope and hence the value of such a demonstration. Instead, we propose alternative ways that our client might better spend its money. The first is to fund research and development into more powerful transmitters and more sensitive rectennae that will help to make demonstrations of this scale more worthwhile. Secondly, finance a more varied assortment of space to space demonstrations at the US \$80 Million level. A third option involves potentially even cheaper Earth to space experiments. A proposal for one such experiment is detailed below.

Earth to Space

The basic plan of this very near-term and very cheap (less than US \$5 Million) design example is to use existing facilities to conduct a trans-atmospheric power beaming test. The technologies demonstrated would be high-power beaming through the atmosphere at long distances, power reception using rectennae in the space environment, degradation of said rectennae with long exposure to radiation and other space environmental factors, and deployment of large inflatable reflectors. Measurements would be taken of spatial and frequency dispersion effects, side-lobes, rectenna efficiency, and power reception as a function of both weather and position within the beam.

Power would be transmitted from the 305 m diameter Arecibo dish at two frequencies. Power levels would be 400 kW from the 2.38 GHz transmitter and 2 MW from the 430 MHz transmitter. Power would be received in a satellite at about 780 km altitude sun-synchronous orbit and would be on the order of 60 W for the 2.38 GHz transmitter. This power would only be received for a short time (1/10th to 1/2 of a second) and might be used to power a flash to illuminate a logo on the reflector for a picture to be transmitted back to Earth, along with the recorded scientific measurements.

The receiving satellite will weigh about 100 kg, and we propose that it be launched on two positions of the European ASAP ring. A 10-m diameter inflatable reflector will be used to concentrate the incident microwaves onto a small rectenna at the focus about 12 m away (see Figure 7). The craft will be gravity-gradient stabilized. Total program costs are estimated to be under \$5 million, with launch within 5 years and mission duration of about 2 years, for 120 measurements.

Further consideration should be given to the possibilities of either using a large military radar system, for which data was not available, or conducting a larger experiment using a dedicated Pegasus (or other system) launch to put a 100 m diameter receiver capable of receiving kilowatts into a higher orbit.

By comparing the amount of technical information they produce to their expense, it can be seen that ground to space demonstrations like this one are extremely practical. For example, almost as much scientific information can be learned in ground to space experiments as can be gathered in space to ground demonstrations. In addition to ground to space demos, it may also be wise to pursue ground to ground applications of beamed technology. Given the large potential market for relayed power,

such experiments may come the closest in the near term to demonstrating commercial applicability (that is to say, they would have to be subsidized the least). But more importantly, a series of ground-based demonstrations and applications would both reduce the high costs of beaming technology and establish an infrastructure that can then be utilized in space-based experiments. If this plan is adopted now, then eventually, perhaps as soon as 10 years, space to Earth demonstrations on the US \$800 Million level can be justified. An example of such a technology-improvement dependent demonstration is proposed below.

Mid term 1 MW Class Space to Earth

We have considered a 1 MW class commercial precursor system in the context of existing or nearly existing construction technology and slightly longer-term beaming technology. The mass of the spacecraft is 80 T at launch and 65 T in operational orbit. The shape (Figure 8) is a triangular prismatic structure built with three square elements 100m x 100m wide, a configuration similar to the SPS 2000 concept proposed by ISAS. After being deployed by an Energia launcher in a 28.5° inclination orbit in LEO, the satellite would be assembled manually by a Space Shuttle crew.

After assembly, the satellite would propel itself to an equatorial orbit. An electric propulsion system is used for both orbital transfer and station keeping, though a conventional cryogenic system might be employed in order to traverse the Van Allen belts at the beginning of the orbital transfer. Since the assembly operations and the final orbit are not in the same plane, there is a mass penalty required to enact this maneuver. Performing this maneuver at final apogee minimizes this penalty, especially when using electric propulsion. Equatorial orbits were found to be desirable because of the extremely poor ground traces of platforms in non-equatorial orbits, particularly at low orbital altitudes

The choice of the altitude of the final orbit has been driven by operational considerations, which are mainly to deliver power for a significant amount of time each day and to provide power density levels on the rectenna compatible with good efficiency. These are actually competing requirements because visibility is maximized in high orbits near GEO and power density is maximized in LEO. Hence we selected a compromise orbit at 20,309 km altitude, which avoids the difficult problem of obtaining an orbital slot in GEO. The orbit is sufficiently high to require concentrating devices at ground level to compensate for the low power densities. The technical and cost considerations lead us to choose static concentrators arranged as parabolic cylinders where the dipole rectifiers are located along the focus line. We believe that this rectenna design would not be much more expensive because the added cost of concentrators is balanced by the smaller number of rectifiers.

We chose the frequency of 35 GHz in order to reduce antenna and rectenna dimensions, since a much larger ground facility some kilometers wide would be needed to accommodate the more conservative 2.45 GHz frequency. A possible alternative to 35 GHz transmitters could be the development of integrated solar array/transmitter 2.45 GHz technology, which could significantly decrease the size and complexity of transmitters required at this frequency. It is important to note that both the mass and particularly the costs of the phased array transmitter utterly dominate the platform design. In order to construct the first platform element for less than US \$1 Billion, it is necessary for the antenna costs to drop a factor of 10-100. To a lesser extent, the solar arrays also contribute significantly to the cost, though their price is expected to drop appreciably within the next decade. Also, advances in electric propulsion technology would significantly reduce the unit costs of each element.

The main conclusion is that from a technical standpoint a conservative demonstration for less than US \$1 Billion is feasible— provided that the necessary phased array antenna and rectenna systems are available in the next 10 to 15 years. While this development may take place of its own accord, we believe that a dedicated ground-based testing program will help to ensure the occurrence of this vitally needed advancement in transmitting technology.

VI. Conclusion: Results & Recommendations

One of our major recommendations is to intensify ongoing research into 35 GHz transmission technology. We feel that this conclusion is exemplary of the ISU philosophy because it was brought about by our multidisciplinary character. This recommendation is based not only on technical and financial rectenna sizing and power considerations but also on such diverse factors as the reduced heating produced by 35 GHz in the ionosphere and the more likely legal availability of this frequency for allocation.

Perhaps an even more important result is what we shall call the US \$800 Million "demo barrier." At this funding level, we feel that space to Earth demonstrations in the next ten years simply do not make financial sense. Instead, we propose that the money be spent on more valuable efforts such as additional space to space demonstrations like the Mir-Progress experiment proposed and ground-based demonstrations such as the proposed Arecibo experiment. Additionally, ground to ground applications should be pursued in order to reduce beaming technology costs for future space to ground demonstrations and to provide such space-based experiments with a much needed ground infrastructure. Furthermore, we feel it makes the most sense to test the environmental and safety effects of beaming through a progressive series of ground to ground and ground to space tests. This step in particular will be pivotal in terms of gaining scientific and public acceptance.

To use a five-step terrace analogy, the "demo barrier" can be thought of as a particularly large step equal in height to any of the other three. The ramifications of this "demo barrier" might be better understood within the context of our proposed program schedule (Figure 3). Both the Mir and Arecibo experiments, as well as others like them, would fit into the level "Demo 1 program" in the technological and spacecraft development lines. Then comes the level "Demo 2 program," which because of the existence of the "demo barrier" will probably not be centered around a single demonstration per se (though the possibility is accounted for) but rather will contain a combination of fundamental research and development, additional "Demo 1 program" type experiments, as well as a thorough series of ground-based experiments. We think that the beaming technology advancements produced by this research-oriented phase will then enable "Demo 3 program" level demonstrations, such as SPS-2000 or our proposed 1 MW class solar power satellite, which we consider to be precursor commercial demonstrations. The first true commercial demonstration would occur at the 100 MW level and is represented by "Demo 4 and SPS development program." The fifth step would be the launch and assembly of a final solar power satellite prototype leading to the final level, "First SPS Operational."

We feel that this 50-year program represents a realistic portrayal of the length of time required to make large-scale space solar power operational, if a reasonable level of technological advancement is assumed. However, we also considered specific technological advances or milestones that might accelerate this schedule by at least 10 and perhaps as much as 20 years, which have been previously identified as "high-leverage" issues.

We believe that perhaps the most important high leverage issue is the advance of laser technology. Lasers offer immense potential for space solar power for numerous reasons, including their high power densities, low divergence, small transmitters and receiver unit size, and potential ability to generate power by means of the illumination of existing solar arrays. However, the technology to do these things affordably does not yet exist. In fact, for the first assigned design example we considered in-depth a laser space to space demonstration for purposes of powering the arrays of an existing satellite, but we determined that the concept was premature. In this sense, the current "demo barrier" is not at US \$800 Million but at US \$80 Million. However, once this initial large step is surpassed, then because of the great potential for more immediate market applications, subsequent steps become much smaller.

As with microwaves, this barrier can be overcome through a combination of intensified research and development and ground-based beaming tests. One interesting application of laser beaming for space solar power is to use a powerful ground-based laser on Earth to transmit power to a remote photovoltaic array. The laser power could be transmitted to ground-based solar arrays, currently existing satellites, or future spacecraft such as Space Station Freedom. In all of these cases the environmental effects of laser beaming should be fully investigated.

Therefore in either the microwave or laser space solar power beaming scenario, we believe it is necessary to conduct extensive ground-based experiments. This leads us to the ironic conclusion that

before we can reap the benefits of power beamed from space to the Earth, we must first effectively beam power from Earth to space.

The complexity of a program on this scale is such that for its implementation, simultaneous progress is needed over a whole range of fields. The environmental and biological safety of power beaming must be scientifically proven and gain public acceptance. New international structures need to be realized to enable real cooperation and collaboration, large-scale funding, and the eventual transition from the public to the private sector.

While none of these obstacles are insurmountable, the big challenge for space solar power is effectively to address all these fields, be they technical or non-technical, in order to become competitive with other energy sources.

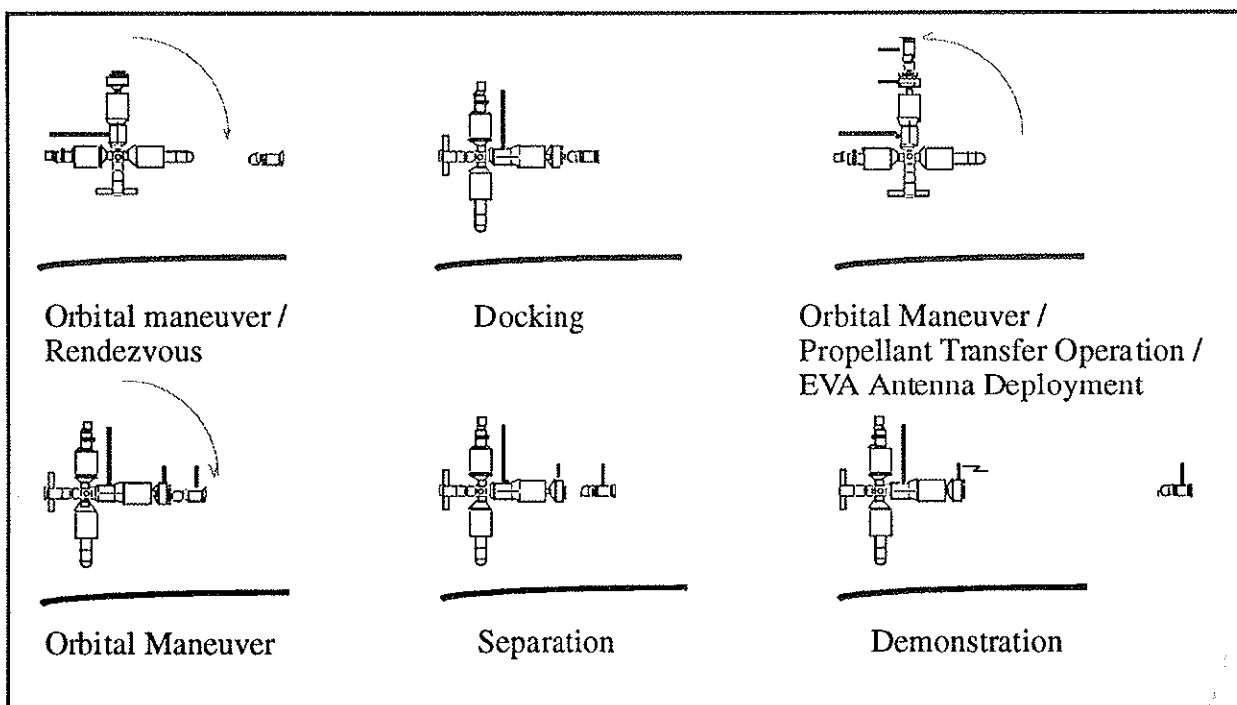
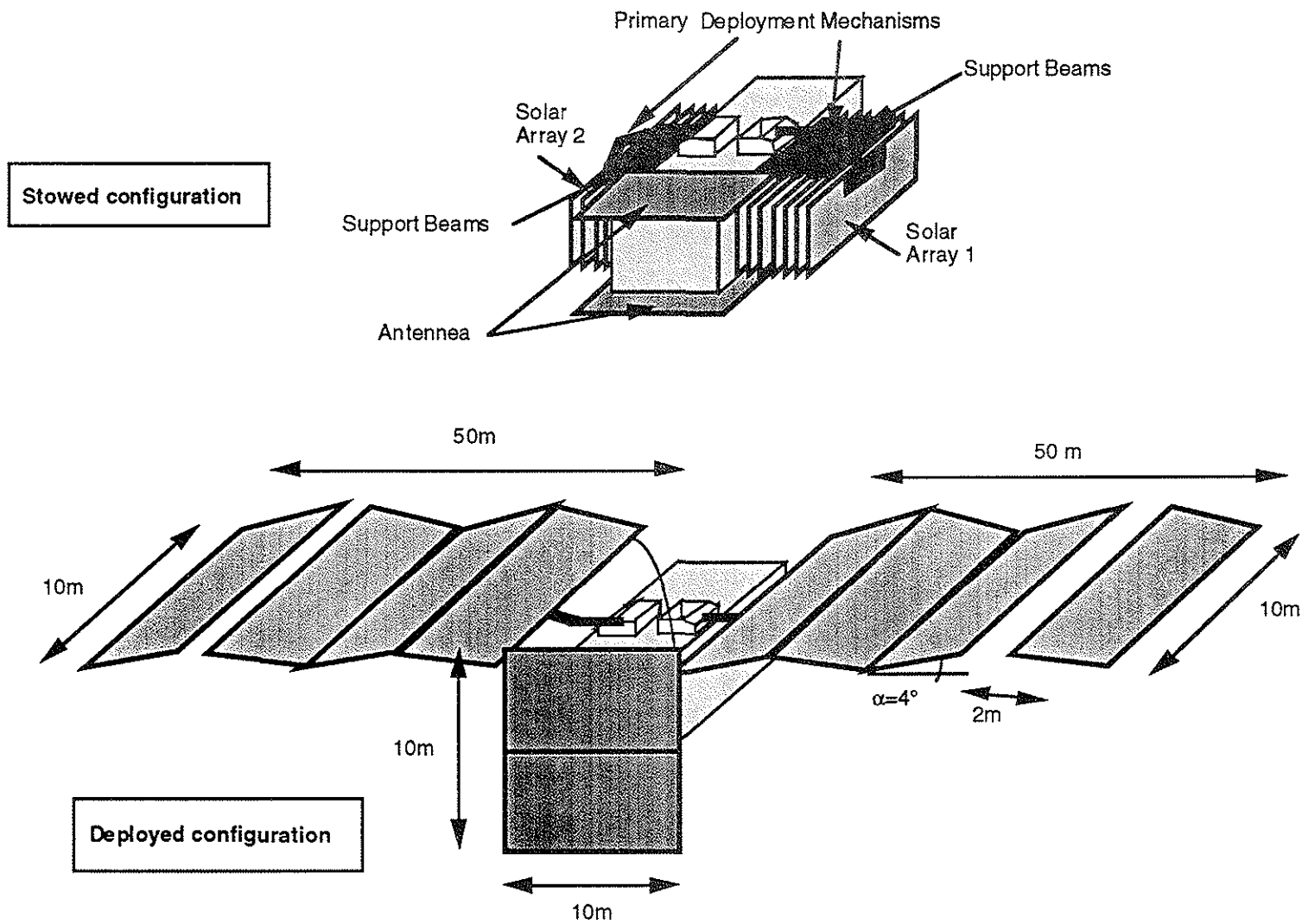

Figure 4 Demonstration Scenario

Figure 5: Space to Earth Satellite Configuration



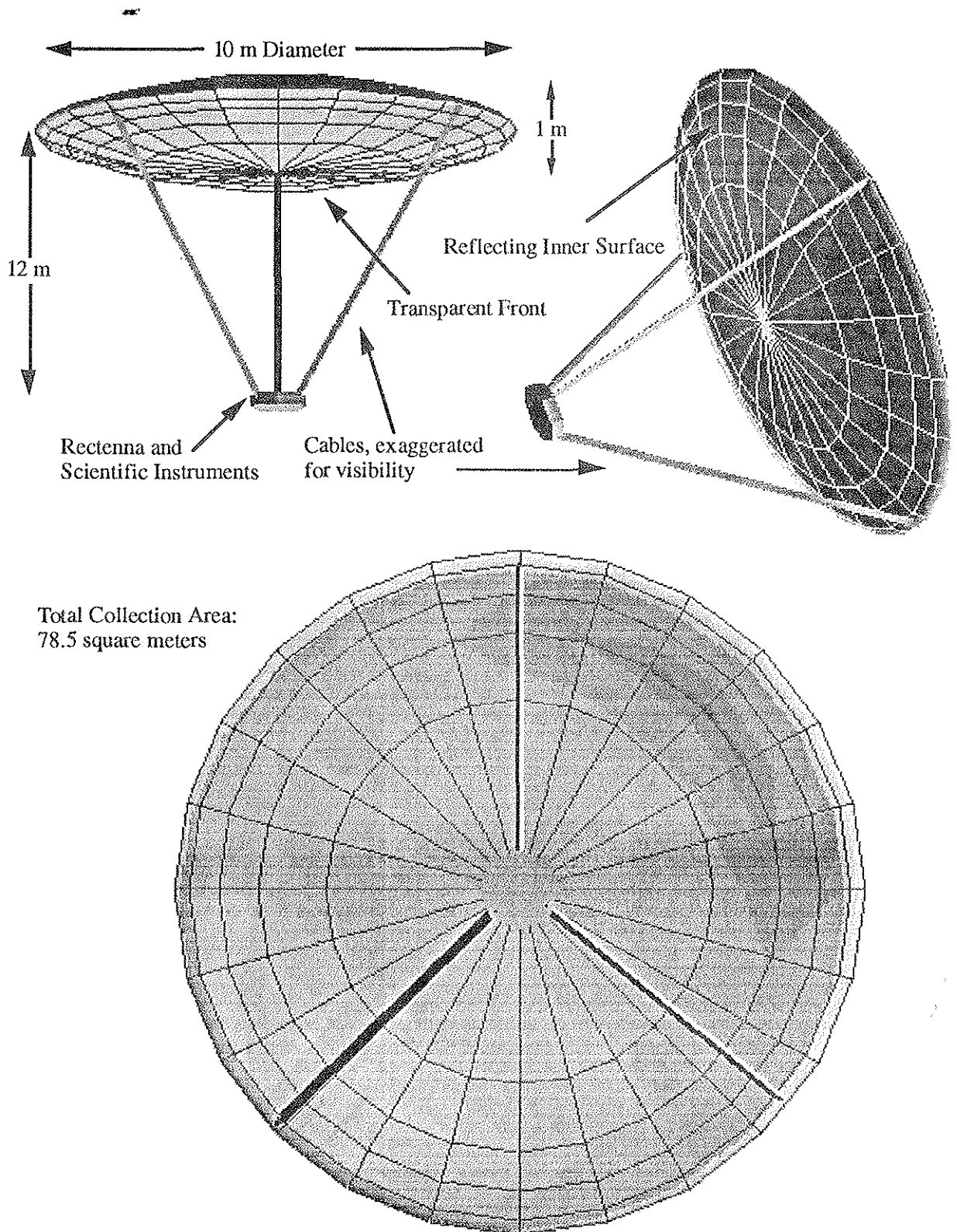

Figure 6 Arecibo Inflatable Receiver Concept

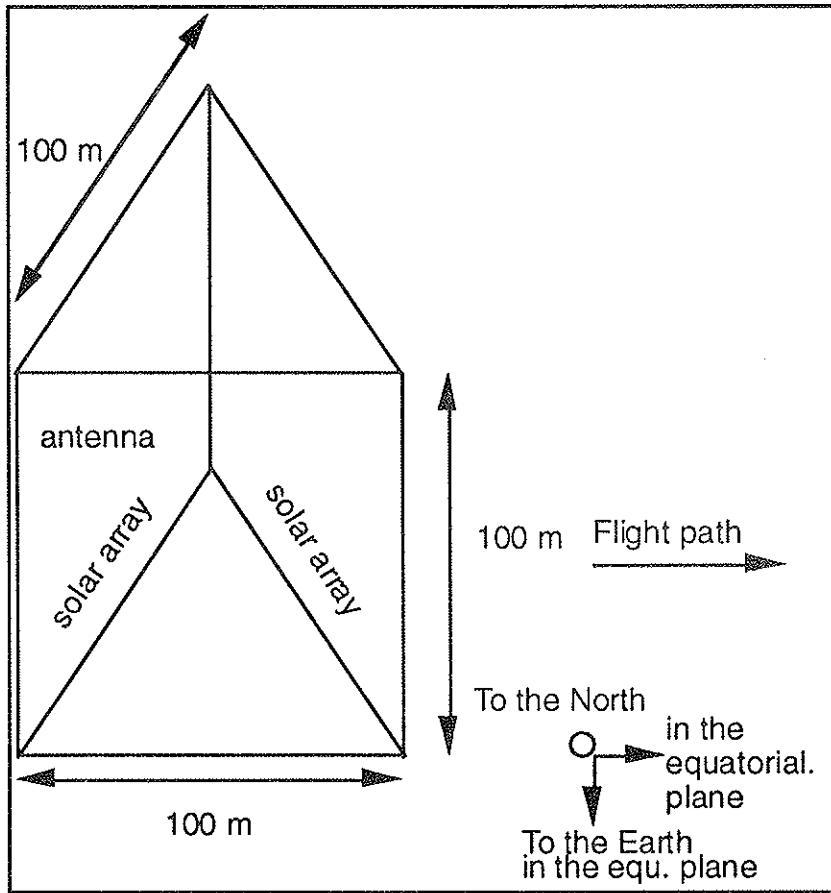

Figure 7 1 MW Class Pre-commercial Demonstrator

1 Introduction

A large international, long-term endeavor such as the development of large-scale space solar power will benefit enormously if it organized around a consistent and well-defined vision. Such a vision serves to unify the many organizations and individuals involved in the project around a common set of goals.

1.1 Vision for the Project

“The Earth is not given to you by your grandparents, it is loaned to you by your grandchildren”
- Traditional saying.

This quote expresses the deep concern that we all should have for our living environment, our biosphere. The biosphere, a vastly complex system comprised of the geosphere, the ecosphere, the atmosphere, and the hydrosphere, is the life support system of our planet. For billions of years it has changed very slowly, shaped by the forces of nature. But recently a new force has evolved within it, a force which has unprecedented power to influence the natural balance of the biosphere. This force is humanity.

As the human population grows exponentially, it rapidly depletes the Earth's resources. Our natural resources are being depleted in two senses: the raw materials used in production cycles are running out and will eventually come to an end, and the waste products of our society are placing an increasing burden on our biosphere.

Among our resources, those which may be used in the production of energy are extremely important, because our ability to harness energy directly affects our standard of living. But, while our present energy resources may last us for another hundred years, they may not last much longer than that, and they are increasingly damaging to our biosphere. Fossil fuels are presently our most important energy source, but their use is a serious burden on our atmosphere. Nuclear fission is expensive and risky and fusion is not yet practical; furthermore, both will always produce radioactive by-products, which at best will be hazardous for over 100 years. Hydro-electric power has a serious environmental impact, and like wind power, it suffers from limited availability. Ground-based solar energy also has limited utility due to varying cloud cover and diurnal cycles.

Clearly, in trying to maintain and increase the global standard of living, humankind is faced with very serious challenges. To make matters worse, the main growth in energy demand will occur in the developing nations which have limited funds and which are therefore likely to adopt inexpensive and pollutive energy systems. Meanwhile, due to the use of fossil fuels, CO₂ levels are dangerously on the rise, air pollution is contributing to acid rain, and oil spills are threatening our oceans and coastlines. We must formulate a global solution to our energy problems, and we must do this as soon as possible.

We are looking for an energy source that will, in a start-up period at least, be used in conjunction with existing sources, but with none of the disadvantages of present sources. Specifically, to be better than existing sources our new energy source should be:

- (1) Long-lasting
- (2) Environmentally safe (the “real cost” of such energy should be minimized)
- (3) Available at all parts of the globe
- (4) Affordable, profitable, and technically feasible in developing nations

The energy source investigated in this report is space-based solar energy. space solar power has the potential to nicely satisfy the criteria for a better energy source. Originally conceived in the early 1900's by the Russian visionary Konstantin Tsiolkovsky, space solar power received a surge of interest in the 1960's when Peter Glaser published a design for space solar power satellites. Glaser proposed that we could provide energy for the Earth using a formation of solar power satellites. Each solar power satellite would be comprised of a large solar array, power conversion equipment, and a microwave antenna with which to beam power to rectifying antennae (“rectennae”) at various locations.

Using such a system, power could be beamed to the surface of the Earth and the moon, and also to other vehicles in the Earth's atmosphere and to space vehicles such as satellites. These applications are very distinct — for example, space to Earth beaming requires very high power delivery, while

space-to-space applications require considerably lower levels of power delivery. The reason for this difference is that in space-to-Earth applications, we must deliver power levels that are competitive with ground-based sources. If we ever hope to replace unsustainable ground-based energy sources with space solar power, we must be able to deliver similar amounts of power to Earth from space. On the other hand, in space-to-space applications, even a low level of power beaming may be able to find a profitable market in the areas of satellite lifetime extension and power delivery to eclipsed objects.

The 1992 summer session of the International Space University (ISU), held in Kitakyushu, Japan brought together 130 students from 30 nations to study all fields related to space. Ranging in experience from university degrees to long-term work backgrounds in the space industry, the ISU '92 student body was multi-disciplinary and multi-cultural, and had an interest in the future of space exploration and development. One facet of the summer session's work was to produce the present design report for a Space Solar Power Program. Unlike many previous studies of space solar power, this study is intended to be comprehensive in its scope — instead of focusing on just one subset of the technical problems related to space solar power, as previous studies have done, this study explores all the aspects of creating a commercially viable space solar power industry. In this way, this broad-spectrum, international analysis may be a useful resource for future research in space solar power.

The Space Solar Power Program will be a grand cultural project of similar scale and importance to other great unifying cultural projects of the past — the Roman aqueducts and roads, the Great Wall of China, the rail systems of various nations, project Apollo, etc. space solar power will help to bring about a sustainable energy ecology on the Earth. Also, through its space to-pace applications, the program will also make an important contribution to humankind's development of space. In the long-term, it will help unite governments, space agencies, industry, environmental groups, and the public behind a common cause of benefit to all. And it will provide safe, accessible, affordable energy to developing nations and to isolated locations, which could be an important contribution to the process of raising the global standard of living on Earth.

However, the task of significantly contributing to the world's energy needs is not easy: with today's global energy demand of 13.5 terawatts (this will be discussed further in section 1.4), a visible solar radiance of 1.3 kW/m², and a power conversion factor from space solar power to usable electric power on the Earth of 10%, we end up requiring a solar radiance collection area of 300 x 300 km². Clearly, such a large solar collection area is presently beyond our capabilities and much work has to be done to enable space solar power to make such a large contribution. However, even though it may be beyond our present means, we should still uphold the goal of eventually making a significant contribution to the world's energy needs with space solar power. For it will be this goal which brings about the motivation and funding necessary to building a future in which such a contribution is feasible.

Depending on the outcome of technological research and design trade-offs, solar power from space may take many forms. For example, it may evolve either as a constellation of large satellites which are visible from the Earth, or as a large moon-based system, or as a combination of both. The trade-offs to be made will be truly multidisciplinary, including political, safety and esthetical arguments, as well as technical and business arguments. But whatever the final system, we recommend that it satisfies the criteria for a better energy source as listed above.

The Space Solar Power Program is, by anyone's standards, an ambitious program. However, we believe that with careful planning and a long-term commitment, such a program can be realized. We envision a future in which space solar power is an important and positive part of the Earth's energy system. We conceive of a future in which humanity has moved into space, not to escape a ruined world, but to broaden the horizons of a thriving home planet, and we hope that space solar power will be a valuable contribution to this future.

1.2 Space Solar Power Program Statement of Work

The task for the 1992 International Space University Space Solar Power Program design project was to consider a full development program from the present state of technology until the point that large international solar power satellites (on the order of gigawatts) are fully commercially operational. This development plan will contain near and far-term milestones. The objective is a global analysis of the program and a more detailed analysis on the near-term milestones. The end-product of the project addresses technical, business, political, environmental, safety, social aspects, and provides a set of recommendations and critical issues.

1.3 An Historical Perspective for Space Solar Power

It is important to consider the development of any project in the context of what has gone before. Here is presented a brief introduction to the history of space power. A more complete list of concepts and references is given in Appendix H.

The utilization of solar power for electrical production on Earth has been proposed by many people. [Brown, 1984] The first important step was to prove that power transmission without wires was possible. Heinrich Hertz first demonstrated the transfer of power between antennae and Nikola Tesla suggested and attempted to implement large scale experiments in 1899. In 1912 Konstantin Tsiolkovski, in "Exploration of the World Territories by Means of Reactive Devices", proposed beaming power to Earth from satellites for the first time.

Significant quantities of power were transferred without wires for the first time in the early 1930s, when H.V.Noble of Westinghouse Laboratory collected power with an antenna separation of 8m.

Little more was said about power beaming for almost 30 years. In 1959 the Raytheon Airborne Microwave Platform (RAMP) was proposed, using microwaves to heat air which drove the rotors of a helicopter, for use as a high altitude surveillance vehicle. In Russia, Nikolai Varvarov talked of "heliostations providing ... electricity in unlimited amount" to Earth, suggesting the use of photovoltaics for the first time, while Kraft Ehrike proposed Earth to Earth power relaying using huge space-borne reflectors to reflect a microwave beam generated on one continent to receiving stations on another.

Isaac Asimov in "Caves of Steel" had future thinkers considering the theoretical notion of beaming power to the Earth from satellites near the orbit of Mercury. [Asimov, 1953]

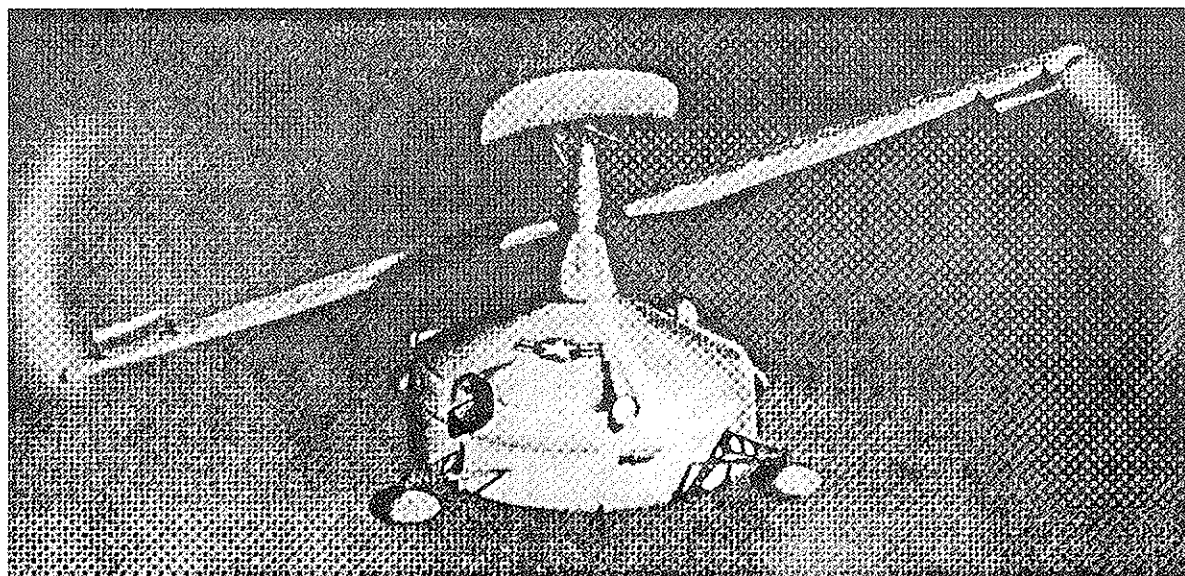

Figure 1.1 Artist's Impression of the RAMP [Brown, 1984]

These proposals were not much more than dreams, as the beaming of power by electro-magnetic radiation had yet to be tested. Practical experiments were successfully carried out for the first time in America. Between 1959 and the 1970's Raytheon demonstrated small-scale laboratory demonstrations of power beaming with DC to DC efficiencies of up to 54%. In 1964 a small tethered helicopter powered by microwaves was demonstrated, followed in 1967 by an untethered model, which flew for up to ten hours. [Brown, 1965, Brown, 1969] These innovations were largely the result of the work of William Brown, who also did a lot of work in developing and improving microwave transmission and reception technologies.

Dr. Peter E. Glaser of ADL Inc. proposed Space Solar Power as a serious concept in 1968. The design involved a geostationary satellite system with photovoltaic arrays transmitting energy at 2.45 GHz to Earth.

In the mid 1970's, when the energy crisis encouraged research into alternative energy sources. Raytheon, in association with JPL, demonstrated power beaming on a large scale in 1975, sending

over 30 kW across one mile with an overall efficiency of 84%. This proved that large-scale power beaming could be a reality.

In a \$20 M study NASA and the US Department of Energy (DOE) examined the problem and proposed a point design for a system of 10 km by 5 km platforms of silicon photovoltaic cells in geostationary orbit beaming to 5 km square rectennas on Earth, the same principles that Glaser had used. Although the study results were positive a National Academy of Sciences overview of the study recommended further study rather than deployment, principally due to unacceptably high launch costs.

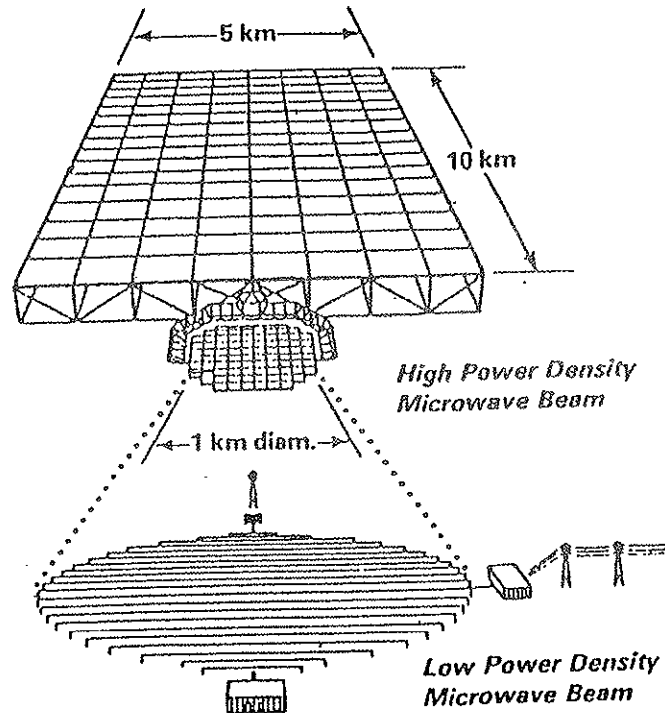

Figure 1.2 The NASA/DOE Reference SPS

In 1985 a proposal was made by David Criswell and Bob Waldron to cover large sections of the moon with solar cells and beam the power from there to Earth.

The potential for utilisation of non-terrestrial materials in satellite manufacture was first observed by Gerard O'Neill in the mid nineteen seventies. The first activity in this area had been two studies examining their utilisation in the reference concept from the NASA/DOE study. General Dynamics and MIT concluded respectively that 90% and 94% lunar material use was possible in solar power satellite construction.

A different approach was used in a study commissioned from Space Research Associates (SRA) by the Space Studies Institute (SSI) in 1985. This study was not limited, as the others had been, to direct substitution of non-terrestrial materials into the NASA reference design concept and considered solar power satellite designs optimised for non terrestrial material use. SRA concluded that solar power satellites could consist of over 99% lunar material, with a significant cost advantage. In a follow-up study in 1989, SRA considered more constrained models for the availability of non-terrestrial materials, with only materials obtained using simple processing techniques available, such as glass and iron.

Since that time there has been renewed interest in space power. In 1987 the Canadian Stationary High Altitude Relay Platform (SHARP) program demonstrated power beaming to an airplane, with the aim of providing a high-altitude communications platform for Canada. Figure 1.3 shows a picture of the test airplane is shown. This program is ongoing, with a larger demonstration in preparation.

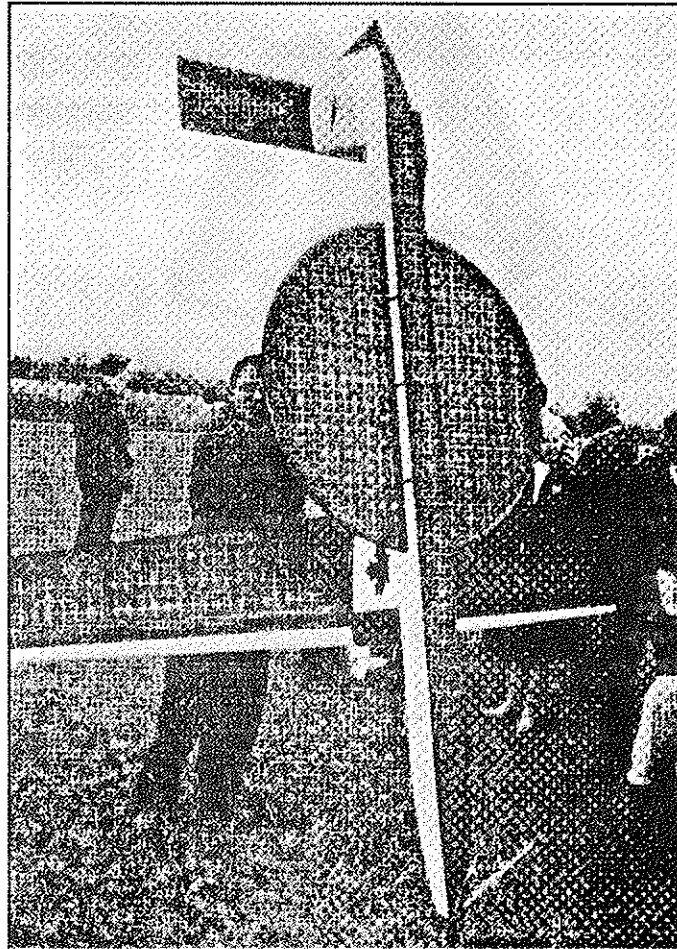

Figure 1.3 The 1987 SHARP test airplane.

In Japan there has been particular interest in space power. The Japanese MINIX sounding rocket experiment demonstrated small-scale beaming over short distances in space in 1983. A more complicated version of MINIX, the Microwave Electric Transmission from Space (METS) involves an experiment to be launched in 1993, to examine power beaming and related areas in plasma physics. The first flight of MILAX, a microwave powered aircraft using a FET phased array transmitter steered with a pilot beam, is imminent.

The ISAS Solar Power Satellite Working Group is using the results of all these studies as a basis for larger scale work. The group has designed SPS2000 as a strawman model for future work. The current design is intended to beam megawatt-level power from an equatorial orbiting satellite to simple rectennas on Earth. A schematic for SPS2000 is shown in Figure 1.4.

Other realistic schemes for testing power beaming on smaller scales have been proposed, notably at SPS '91, a conference in France at which almost 100 papers were presented to an audience of interested scientists and engineers. It now appears certain that there exist markets for which power beaming could be economical, even in the medium term.

While many people have proposed individual designs for hardware, there has yet to be a study outlining a possible evolutionary path to large scale solar power transmission for use on Earth or elsewhere. This is important because a system design that involves massive investment and requires answers to many currently unanswered questions has no hope of being built, whereas a single experimental satellite offers no vision. A more gradual evolutionary approach holds much more interest, and that is what is presented in this report.

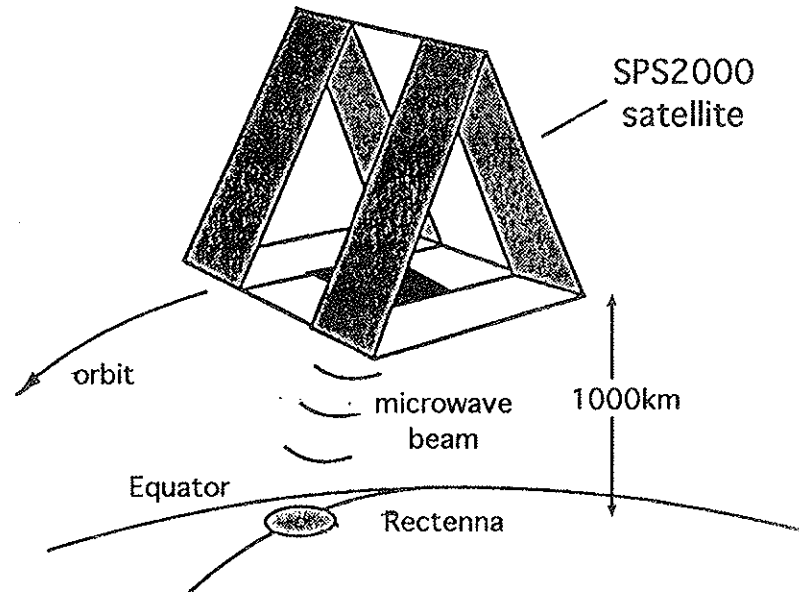

Figure 1.4 Schematic for SPS2000

1.4 General assumptions

This section contains a list of assumptions made while writing this report. These assumptions are important when trying to use the results of the study once some circumstance has changed. However, this section does not contain information which is not, maybe implicitly, present in the rest of the report. Some very detailed assumptions are left out here when addressed in the specific chapters. An attempt has been made to group the assumptions according to specific chapters, but in some cases the same assumption may be shared in different sections without being repeated in all of them. Note that assumptions sometimes directly translate into requirements.

Chapter 1, Introduction

- Humankind has to strive to find a way of living for the complete Earth which is sustainable in the long term.
- A newly developed energy source has to be long-lasting and environmentally more safe than alternatives.

Chapter 2, Energy Analysis

- World population is expected to increase significantly during the 21st century. The UN estimates about 10 -14 billion people living on our planet until 2100.
- It is predicted that the energy consumption will somewhat stabilise or even decline in the developed countries, whereas the consumption in the developing countries will linearly increase.
- Consequently global energy consumption will increase.
- Environmental factors set a limit for energy production from fossil fuels and nuclear energy.
- Application of new technologies and conservation policies will improve the efficiency of energy use.

Chapter 3, Markets

- The cost of conventional energy resources have a stable, present value; at present, the cost for environmental impact is not yet factored in.
- Markets depend on location, level of industrial development and existence of different sources of energy.

- For mid-term applications a time frame is assumed where sufficient experience is gained with power beaming technology to emplace commercially active power in space, but not yet on the scale necessary for commercial power beaming to the Earth.
- Space solar power delivery to the electricity grid is not yet done on a large scale for the mid-term time range.
- Market possibilities for beamed power in the long-term are hard to describe with accuracy but may extend beyond earthly limits.
- Long-term markets for beamed space power in space need to include: orbital manufacturing facilities, space habitats, lunar and planetary bases and transportation networks.
- For long-term applications, power delivery by space solar power to the electricity grid can be done on a large scale; space solar power is seen to be fully capable of replacing currently used energy sources.
- To sell the Space Solar Power Program we need to promote the benefits and rewards of a cleaner, reliable and abundant source of energy.
- It is necessary to target all the possible players: they are different for different cultures and educational background.
- The economic viability of the Space Solar Power Program will be dependent on the costs, the economy and the price of alternative, conventional and other future power systems.

Chapter 4, Overall Development Plan

- The Space Solar Power Program requirements consist of technical feasibility, business viability, environmental and safety acceptability as well as political and social acceptability.
- Developed countries have to provide an alternative, clean energy source for developing countries in order to safeguard environmental properties of the Earth.
- A macro-project like Space Solar Power Program has to find self-sufficient project parts to fulfill stages of development towards a final large scale program goal; staged growth is necessary for success.
- Use of non-terrestrial materials for space construction introduces major uncertainty into the development plan since it introduces interfaces with space exploration programs.

Chapter 5, Organizational Plan

- Science is used as a partial driver for Space Solar Power Program justification and funding.
 - Funding will be from space programs until large scale power is available.
 - There will be no commercial viability until large scale power is available.
 - The Space Solar Power Program will not violate any existing treaties or international laws.
 - A Space Solar Power Program will provide many new jobs, even in the case of the use of robots for system construction.
 - The general public can provide support to a Space Solar Power Program in order to find funds.
 - It is necessary to create a public awareness of the energy and environmental problems of our society.
 - The general public needs to be educated about the Space Solar Power Program: how it works, its benefits and problems.
 - The Space Solar Power Program is for the benefit of the public, not merely a profit-making venture.
 - The Space Solar Power Program is an international project, every involved country shares responsibilities and profits.
 - The public has social and cultural heterogeneity.
 - The mass media play a fundamental role in communication.
 - Establishing a strong and effective public image is a dynamic process.
 - Having an open flow of information is important.
-

Chapter 6, Environment and Safety Issues

- The manufacturing and operational phase of the Space Solar Power Program will not affect safety of spaceflight; other spacecrafts will not be affected.
- Solar power satellites at the end of life or out of control will not be dangerous to the Earth and its inhabitants.
- An evaluation of the perturbations of international communication links is necessary: the effects should be negligible.
- Actual present knowledge about effects on the atmosphere are unsatisfactory.
- Actual present knowledge about effects on biota are unsatisfactory.
- Power beams directed towards the Earth should be limited to specifically designated areas; inside these areas there should be a very low level of impact on biota; outside these areas there should virtually be no effect; this is to avoid damage due to mal-use or mal-functioning.

Chapter 7, Power Systems

- Laser power beaming as compared to microwave power beaming is considered to be less efficient, more susceptible to atmospheric influences but requires smaller receiver areas.
- Receiving areas need a buffer zone to ensure safety of people, both in case of microwave and laser power beaming.

Chapter 8, Space Transportation

- Launch costs are very high and a possible "show-stopper" for large scale solar power application (a show-stopper is a circumstance that makes a project unfeasible).
- It is possible to reduce launch costs by a factor of 10, when design, manufacturing and operation are optimized with regard to launch costs.

Chapter 9, Manufacturing, Operations and Construction

- Space solar power satellites will be of the class 'Large Scale Structures' and require according technology and modelling.
- Utilization of non-terrestrial resources is a means to reduce the amount of mass to be transferred from Earth to space.
- Construction of both in-orbit and non-terrestrial structures require major technological development.
- Manufacturing of the components of the Space Solar Power Program will be done with materials with a high occurrence on Earth, moon, asteroids, etc. and will save important materials (oil, coal,...) for other purposes than power supply.

Chapter 10, Design Examples

Specific assumptions made in the various design examples can be found in the relevant chapter.

Chapter 11, Finance

- Programs for developing/realizing solar power from space should strive for commercial viability.
 - A Space Solar Power Program does not provide return of investment in the early phases
-

References

Asimov, I., The Caves Of Steel, Doubleday and Co Inc, 1953

Brown, W. et. al., "An Experimental Microwave Powered Helicopter", IEEE Int. Convention Records, Vol. 13 part 5, pp. 225-235, 1965

Brown, W., "Experiments Involving a Microwave Beam to Power and Position a Helicopter", IEEE Trans. on Aerospace and Electronic Systems, Vol AES-5 no 5, pp. 692-702, 1969

Brown, W., "The History of Power Transmission by Radio Waves", Trans. on Microwave Theory and Techniques, 1984.

2 Energy Analysis

This chapter provides context and a basis for evaluating the need for the space solar power program which will be developed in this report. First, a need for terrestrial energy is identified. Section 2.1 gives an overview of the actual energy demand and breakdown of energy consumption in the different economic developed regions of the world. Furthermore it provides information about future demand projections, including modeling for different demand and population growth scenarios. The actual amount of energy actually provided will depend on a variety of factors including production cost, available supply, and other market related issues. Then section 2.2 will address the question of *how* these energy needs might be provided. Discussion includes a description of the various sources of energy and their characteristics, the conversion processes for the major uses of energy, and the cost (present and future projections) of providing energy from each source. For Earth applications, a cost target is established to help determine the circumstances under which space solar power will be cost effective. Section 2.3 addresses energy supply and demand for space applications.

2.1 Terrestrial Energy Demand and Models

According to United Nations estimations the population of the world is expected to increase significantly during the 21st century, with the largest percentage in the developing countries. Currently these countries are using one order of magnitude less energy per capita than developed countries. While the energy consumption in the industrialized countries might somewhat decline due to conservation policies and new technologies, the increase in world population and improvements of the living standard in the developing countries will necessitate a factor of 2-5 more energy production for the world. As energy production itself is responsible for more than half of the environmental problems facing humankind, we have to think about alternate energy forms which reconcile both: enough energy for the world and protection of our biosphere.

2.1.1 Current Energy Consumption

It is common practice to divide the global economy into three distinct groups. This division is based on the fact that countries within these blocks have broadly similar economic structures, growth patterns and energy consumption. Thus it is a more fundamental breakdown than a regional one.

- Organization for Economic Cooperation and Development (OECD) Countries
- Less Developed Countries (LDC)
- Former Eastern Block (FEB)

In the OECD countries there is currently a large amount of energy use, but the potential for efficiencies and conservation is strong. The former eastern block is undergoing a major transition which will require a further increase in energy usage until market adaptations and application of new technologies have been completed. Less developed countries are currently at a low level of energy consumption, but they will require a substantial growth in energy usage in order to achieve an economic status similar to either of the other two blocks. In order to realize a future which enables the less developed countries to reach a higher standard of living an increase in their energy use will occur. To guarantee a sufficient supply without having to compromise global environmental goals such as reducing CO₂ emissions, we have to look for new sources of energy.

Energy Breakdown

In this section the breakdown of energy consumption for the different regions of development in the world (so far as there are data available) is described, according to the following divisions:

- transportation
- manufacturing
- residential
- commercial (public, services).

There has been a very rapid growth of energy use in the past century. Regarding the last 10-20 years developed countries made important progress in halting energy growth, but energy consumption is growing again in some of these countries, such as the USA mainly due to personal transportation and

heating/cooling of residential and commercial buildings. As the amount of energy used per capita is mainly influenced by how efficient energy is used and by the effectiveness of energy conservation, this growth is not expected to continue at the same rate because of factors like improvements of technology standard, availability of resources and environmental problems involving pollution, safety and hazards. OECD countries use approximately 48% of global primary energy whereas LCD countries use 16%. [Mayur, 1991] For example an average farmer in Asia uses less than 1% of the energy consumed by an average American.

The current energy needs are about 12 TWy/year (note that 1 TWy/year = 8760 TWh/year) [Dechamps, 1991]. Per capita use varies from about 52560 to 65700 kWh/year for OECD countries to about 8760 kWh/year for developing countries. [Martin, 1991]

Due to limited data energy consumption breakdown for OECD countries in this context includes only energy generated from fossil fuels. The energy use is divided in four different categories: residential, commercial, industrial and transportation. The definitions for these terms are as follows: Residential means energy consumption in private households, commercial includes public buildings, offices, stores, schools, hospitals, and others. Industry and manufacturing include primary metals, chemicals, petroleum and coal products, paper and allied products, food products, stone, clay and glass, agriculture, mining and construction, and petrochemical feedstocks. Transportation includes all vehicles such as cars, buses, trucks, ships and air transport.

Breakdown Results for OECD

Energy intensity is defined as the ratio of energy consumption per capita per year to the capita gross domestic product per capita per year. Thus energy intensity reflects the combination of energy consumption and the economic development of a country. Energy intensity is not only affected by factors such as geographical location, climate and consumer behavior, but also by the structure of the available primary energy sources, technical and economic standards of energy production and consumption. [Levai, Jaszay, 1991] The so-called energy intensity showed a decline between 1973-1986 both in Europe and USA at an average rate of 2.2% and 2.4% per year respectively, due to improved efficiency in energy use. [Goldemberg, 1991] The energy breakdown as shown in Figures 2.1. and 2.2. contains only fossil fuels use in the USA, but we assume that the consumption pattern in the other developed countries is similar to that of USA. Fuels in this context are raw natural resources such as oil, natural gas and coal.

These graphs indicate that the relative percentage of energy consumption did not change significantly during a time span of 13 years, although the absolute energy use is still increasing. We could not find data for similar energy end use breakdown for developing countries, but it is assumed that the overall energy consumption behavior in relative terms is very similar to that of developed countries (see below).

Breakdown Results for LDC

Energy consumption has been increasing linearly in developing countries for the last decades. Regarding the growing population and the development goal to be achieved - reduction of poverty - increased use in energy and raw materials will be required. Developed countries are asked to help in this situation mainly by bringing new technologies to these countries and hence improve efficiency in energy production, end use, conservation and resource development. The data we present here are from Brazil, which can be used as a model for a developing country. [Reddy, Goldemberg, 1990] The end-use breakdown is only related to electricity use in typical household and is compared to USA household energy use. The data indicate that the energy use habits of the non industrialized world have a generally similar pattern, although their levels of total energy consumption are much lower in absolute terms.

- Brazil residential energy consumption: 1460 kWh/year
- USA residential energy consumption: 7345 kWh/year

Note that these values compared to the total energy consumption values given on the previous paragraph (energy breakdown) match to those shown in Figure 2.2. If the present trend continues, in about 25 years the LDC's energy consumption will reach the present state of consumption in the industrialized countries. [Goldemberg, 1990] Assuming that the population growth is mainly located in these regions, a great increase in energy demand will occur. Hopefully developing countries will be able to use energy saving techniques created by richer ones and hence have a benefit in terms of more

efficient energy usage, resulting in a smaller increase than expected from the population growth increase.

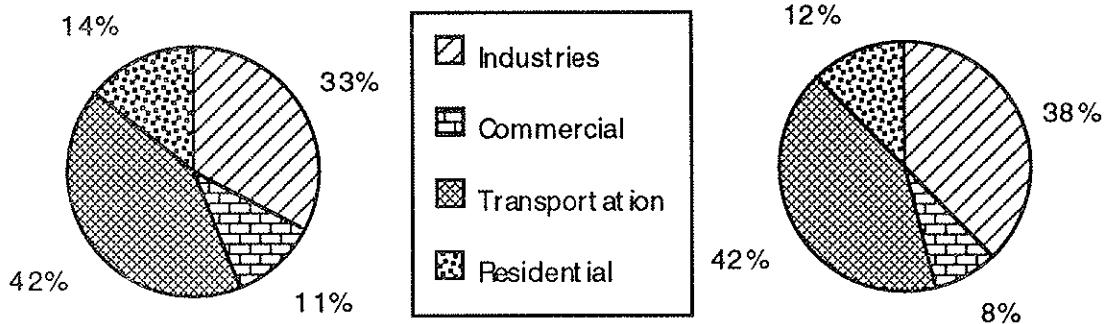

Fig. 2.1
U.S. Energy breakdown
for 1978

Fig. 2.2
U.S. Energy breakdown
for 1991

Figure 2.1 and 2.2 Energy Breakdown Results for the Years 1978 and 1991

Breakdown Results for FEB

The events of 1989 changed the political and economic situation in Eastern Europe; it is not a single unit any more, but from an energy standpoint of view, these countries can still be treated as an unique entity. No precise data for a usage breakdown in terms of residential, commercial, transportation and industry were found. In this section we point out more general comments on the situation in the former eastern block countries. Energy consumption in Eastern Europe has been growing linearly for a long time and shows no tendency to saturate. The efficiency in energy use in FEB countries at the moment seems to be still very low due to former political and economical situation, but there is a great potential for efficiency. Current trends would increase energy demand by almost 50% by 2025. In general the per capita energy consumption per year is very high and the per capita gross domestic product per year is very small, resulting in a 3 times higher energy intensity than in OECD countries. [Levai, Jaszay, 1991] Regarding the residential sector in Russia, the per capita consumption is low but the efficiency is not very high. Hence energy demand for the residential sector in Russia would more than double by 2025 in the absence of national energy policies. [Chandler, 1991] Without economic reforms, the Polish economy also would double its energy consumption by 2025. Also the transportation sector shows great inefficiency in FEB countries. As an example, the cars need relatively more gasoline than western cars, comparing the transportation capacity and horsepower. It is assumed that people in these countries will improve their standard of living, the energy consumption will increase enormously. So the energy demand could only stabilize or decline in Eastern Europe if there are economic reforms introducing the best technologies available at the moment.

The reduction of energy demand in the industrial sector could come from structural shifts combined with standard energy conservation measures incorporating new standards which are available in the OECD countries. These reforms have the potential to reduce the energy demand by one-sixth over the next twenty years. The environmental situation in these countries will require these reforms have to be done soon. The combination of economic reform and the introduction of energy efficient technologies could hold energy demand virtually constant, or as predicted in very optimistic scenarios the total energy use goes down, as is the case in OECD countries. The success will depend in part on the cooperation of the western nations with the former eastern block countries.

Conservation

In the past twenty years the OECD countries have made important progress in energy saving policies. This decrease in energy growth could be attributed to factors such as: steady advances in technology,

recycling, conservation policies, etc. Industrial processes are much more effective nowadays, because of improved equipment and new technologies. Many of them were developed during and after the oil shock of the 70's. Another important impact on efficiency concerning the raw materials is recycling. For example, just 5% as much energy is needed to recycle aluminum as to produce it from bauxite, the original raw material. Therefore recycling materials can lower the total energy consumption.

Other studies show that the energy efficiency of buildings could double by 2010 by using new technologies such as advanced technology windows, compact fluorescent lights, shade trees and light colored buildings. [Bevington, Rosenfeld, 1990] Also we should keep in mind an early technology transfer to the FEB and LDC countries to avoid the same mistakes which were made in the western world in the past decades.

Extracted Trends

This section describes a trend analysis for world energy use in the sectors of residential, public, industry and transportation. Residential and public buildings data were available for USA only.

Residential and Public / Commercial Buildings

Buildings use 36% of total USA energy supply and commercial buildings alone had an annual energy bill of \$200 billion. During the time of oil crisis in the 70's, the energy use in homes and buildings fell some 30%. Although building improvements continue, energy use in the building sector is growing at the rate of 3.3% per year in the USA. [Bevington, Rosenfeld, 1990]

Industry and Manufacturing

Industries consume 2/5 of the developed world's energy. Output has risen but total energy consumption has gone down, due to making industrial processes more productive by investing in conservation. The amount of fuel consumed by USA industry overall per unit of output has declined by 50 percent during the past 30 years. This decline is due to improved efficiencies of equipment, recycling of scrap material, continuous process improvements, and new technological breakthroughs. The most energy intensive step of manufacturing is the initial conversion of raw materials. More than half of energy consumption is converting ores and feed stocks to basic commodities such as metals, glass, plastics, and paper. The remaining energy use is agriculture, mining, construction, and manufacturing of intermediate and finished products such as food cans, newspapers, magazines and vehicles. Currently, companies recycle most scrapped materials, but once items are passed to consumers, recycling will significantly drop. For example, about 40 percent of inputs to steel making consist of recyclable materials from outside the mill. [Ross, Steinberger, 1990]

Transportation

One half of the world's oil is consumed by 500 million road vehicles. Currently, the number of vehicles is growing faster than the human population. The growth of vehicle use is 4.7% per year for cars and 5.1% per year for buses and trucks. By 2030, studies project that there may be 1 billion vehicles on the world's roads. The growth of vehicle use is 4.7% per year for cars and 5.1% per year for buses and trucks. [Bleviss, Walzer, 1990]

2.1.2 Future Energy Consumption

More than 12 billions humans in the next century could populate this planet without having severe physical constraints on raw material, food and environment. [Gaudin, 1991] Regarding energy, some constraints appear: consumption of fossil fuels will be limited for environmental reasons, use of atomic energy will be restricted to those countries which accept its risk and can acquire technology, and hydroelectric power is limited by geographical reasons. The energy needs per year are now about 12 TWy/year (note that 1 TWy/year = 8760 TWh/year) computed for a world population of 5.4 billion inhabitants. Depending on the model assumptions the projected energy needs for 2020 are in a range of 11-28 TWy/year for a population of about 7.4-7.8 billion people and, for 2100 the energy needs will be in a range of 17-50 TWy/year for a world population of 10-14 billion. [Deschamps, 1992] In this section the model assumptions will be examined.

Predictions

What can be predicted from today's energy consumption behavior related to the different economic blocks: OECD, LDC and FEB. A first scenario for future demand could be that energy usage per

person in OECD remained at the same level as now. If newly industrialized countries also used this same amount of energy, the total annual requirements would increase by about five times the current amount by 2100. More optimistic scenario predicts that industrialized countries and newly industrialized countries halve their per capita energy usage by the end of the next century, whereas the developing countries increase their energy consumption. These calculations lead to an usage less than 2.5 times the current level, a detailed description of these different assumptions will follow in section 2.1.3.

The total world energy demand for the year 2100 will be, depending on the model, 2.5-5 times the current value, but the large predicted population increase over the period would result in a minor fall in worldwide per capita energy use over the period. With economic growth much stronger in the developing world than the developed world, much of this reduction in per capita usage must be met in the developed world. Current trends suggest that the increase in energy demand could be much larger than the available supply. Extra demand for energy does not mean that extra supply will become available. *Thus energy supply limits economic growth.* There was no net per capita decrease in world energy usage between 1980 and 1987. If this trend continues for the developed world there would be a large gap between available energy and required energy by 2100. The gap would be even larger if it is assumed that the per capita energy use in the developed world continued to grow even at a moderate rate. In the case of such an 'energy gap' appearing, it would become necessary to fill it with new sources of energy. These could be anything from nuclear fusion to safer second-generation fission plants, solar terrestrial power and space solar power. Even if there is only a small increase in energy needs, a cheaper and cleaner energy supply is economically helpful and makes the world's standard of living increase. The main criteria for selecting new sources will be based on cost, reliability and public acceptance of these new solutions.

2.1.3 Population Growth and Energy Demand Models

The first step in estimating future energy needs of the world is to estimate world population levels. The historical record shows that population growth is intimately related to patterns of energy use and advances in technology and by extension to patterns of environmental degradation. Population variables and projections are used as inputs in energy models and, more recently, in models of CO₂ emissions. There will be a description of four models in this section:

- UN Population Growth Model with Extended Version of the World Bank.
- Future Energy Usage Projection Model by Lomer
- New Options for Energy Model by Dessus and Pharabod
- Oak Ridge Long Term Global Energy CO₂ Model by Emonds and Reilly.

UN Population Growth Model with Extended World Bank Version

The United Nations carried out a demographic analysis for the world population growth until the year 2020. [UN population study, 1986] The actual world population now is about 5.0-5.4 billion people, 75% living in developing countries. In numbers that is 1.25-1.35 billion people in developed countries and 4.75-4.05 billion in developing countries.

Since the history rate of population growth in the developing countries is higher than in developed countries the assumptions for the future were:

- 3-4% growth rate per year in developing countries, with population doubling times of 20-40 years.
- Less than 1% growth rate per year in developed countries.

The growth rates from the beginning of this century until now were taken for the computations. In the years 1965-70 the world population peak annual growth rate was 2.04% per year, whereas in 1985 the growth rate went down to 1.65%. This number was taken for the High Growth Model, indicating a population of 10 billion people in 2020. The next UN projection was a Medium Growth Model, with a growth rate of 1% per year, resulting in a population of 7.8 billion by 2020. A Low Growth Model was calculated with a growth rate of 0.5% per year, estimating 5.5 billion people in 2020. The most reasonable view seems to be a world population of 7.8 billion, with 1.4 billion living in the developed countries and 6.4 billion living in the developing countries.

A further demographical analysis was carried out until 2075 and 2100 from the UN and the World Bank. [Choucri, 1990] The medium growth rate model was again taken for the projection until 2020.

The growth rate for the calculation from 2020 to the year 2100 was assumed to be 0.5%, resulting in a population of about 10-12 billion. In Figure 2.3, the UN and World Bank projections are shown.

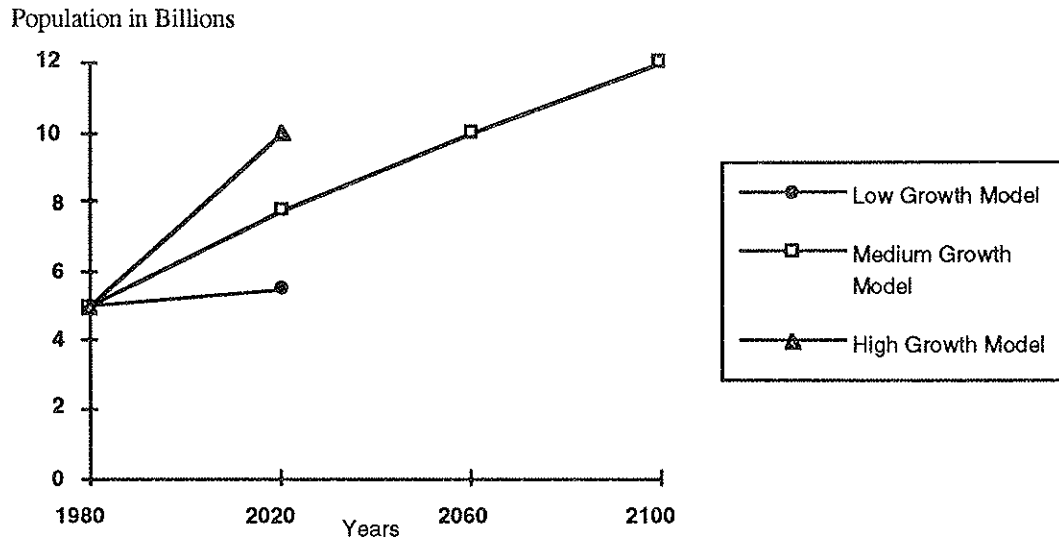

Figure 2.3 Projected World Population until 2100

Future Energy Usage Projection Model by Lomer

This model provides three different scenarios for future energy demand as shown in figure 2.4. The assumptions are as follows. For *scenario one* the case of industrialization of one third of the developing countries in each 40 year period is given, for *scenario two* an industrialization of two thirds of the developing countries in each 40 year period is presumed. For both it is assumed to halve the energy consumption in the industrialized and newly industrialized countries at the end of the next century.

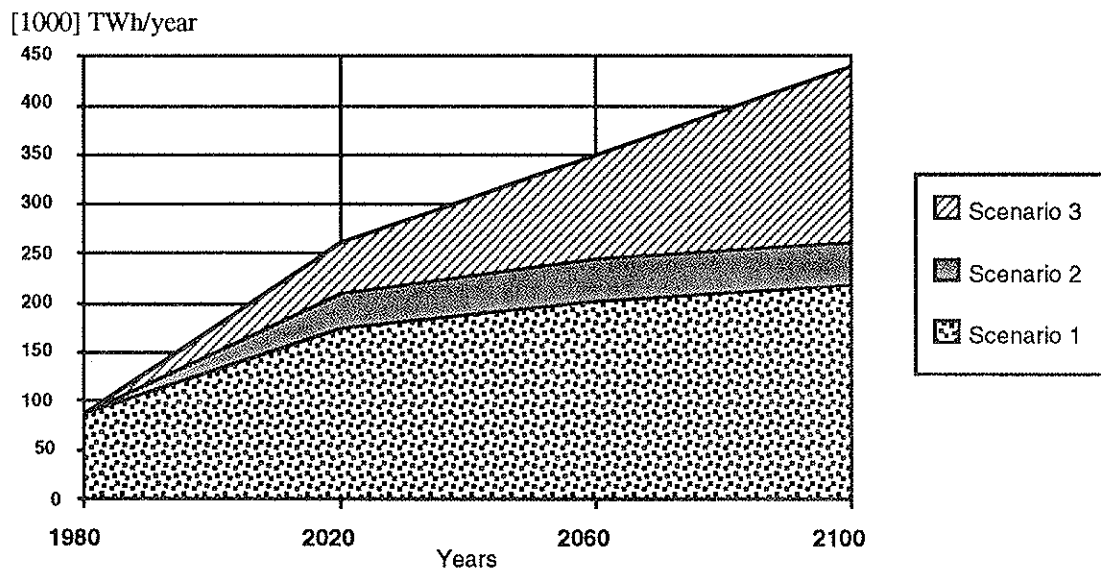

Figure 2.4 Future Energy Demand for Different Growth and Energy Consumption Scenarios.

The calculation for the first scenario leads to an energy usage of about 2.5 times the current level of 10-12 TWy/year. The second one predicts an energy use which is about 3 times higher than the present value. [Lomer, 1991] But these two projections are very optimistic in terms of decreasing energy consumption in the developed countries. It seems to be more likely that the energy use per capita will remain at the same amount consumed now in the industrialized countries and that the

newly industrialized countries will also use the same amount. These are the assumptions for the *third scenario* showing a five fold increase of the current energy need until 2100. [Martin, 1991]

It is clear that the sources of energy are inadequate to meet these future energy needs, even if we look at the assumption made for scenario 1 and scenario 2 of halving the energy consumption in the industrialized countries and in developing countries staying at the present low level of consumption. Unless all energy conservation policies will be effective to have less than the double energy usage of the current rate, these projections seem to constrain the development of the non industrialized countries. The third scenario, predicting a stabilized energy consumption in the developed countries at the current level and an increase of consumption to the same level in the developing countries, seems to be realistic.

New Options for Energy Model by Dessus and Pharabod

This model examines a possible evolution for energy demand assuming no sudden shifts in energy production or introduction of new energy sources. It reflects the major environmental concern facing the world while allowing for the structure of developed societies to reach a per capita energy usage approximately half of that in the currently developed countries by 2050. [Dessus, Pharabod, 1991] It is also a low economic growth model with emphasis on sustainability in economic and environmental terms. The increasing importance of environmental impact into energy costs leads to the need for alternative sources which should be also more economically attractive. According to most environmental forecasts continuation of the current emphasis on worldwide economic growth and ever-increasing industrial output levels would lead to an unsustainable buildup in greenhouse gas levels and depletion of fossil energy stocks. Thus the assumptions are the following:

- Stabilization of CO₂ emissions by 2100 to levels that the atmosphere can absorb.
- Population growth to 11 billion, taken from the UN estimates (UN Pop. Bull. 1982).
- Reduction in per capita energy demand of 50% in the developed world by 2050.
- No nuclear fission power beyond 2100, and no new capacity beyond 2070.
- Evolutionary development of currently-existing alternative energy sources.
- Renewable energy sources in substitution for fossil fuel resources.

This model comes up with a very small increase of future energy needs in 2100 which are far behind the estimated values in the other models. It seems to be too restrictive in terms of environmental issues and economic growth.

Oak Ridge Long Term Global Energy CO₂ Model by Edmonds and Reilly

The Oak Ridge Long Term Global Energy CO₂ model was developed by Edmonds and Reilly 1983-85 and provides future energy demand and CO₂ balances to 2100. [Edmonds, Reilly, 1985] This model calculates the change in atmospheric CO₂ concentration that results from the emission of CO₂ into the atmosphere from fossil fuel combustion. By imposing the greenhouse constraint a limit is set on the allowable fossil fuel use for energy production. Out of this model it is possible to determine to which extent fossil fuel alternatives should be developed and deployed. The energy demand was calculated out of information as population growth and technology improvement parameters, to forecast the regional and global gross national product and therefore energy demand, using the correlation between energy consumption per capita and GNP per capita. The allowable energy production from fossil fuel was determined by the need to prevent the global greenhouse warming and is shown in Figure 2.5. A shortfall in energy becomes apparent and this shortfall will be the reason for using non fossil fuel energy sources. In order to hold the globally averaged temperature to its 1990 value, fossil fuel energy production must be cut down immediately by two thirds. If we allow a 1 degree Celsius per century global warming the fossil fuel energy production must be reduced by one third. [Hoffert, 1991]

This figure shows a projected world energy shortfall, determined by subtracting allowable fossil fuel energy production (based on a 1% annual decrease in fossil fuel energy production from 1990 on) from the projected annual fossil fuel energy demand. The allowable production was determined by the need to prevent the global greenhouse warming. [Hoffert, Potter, 91] The energy demand for 2100 in this model is also predicted to be at the same level like in the third scenario given in the model of Lomer. Note that $1e+12$ Gigajoules /year = 32 TWy/year.

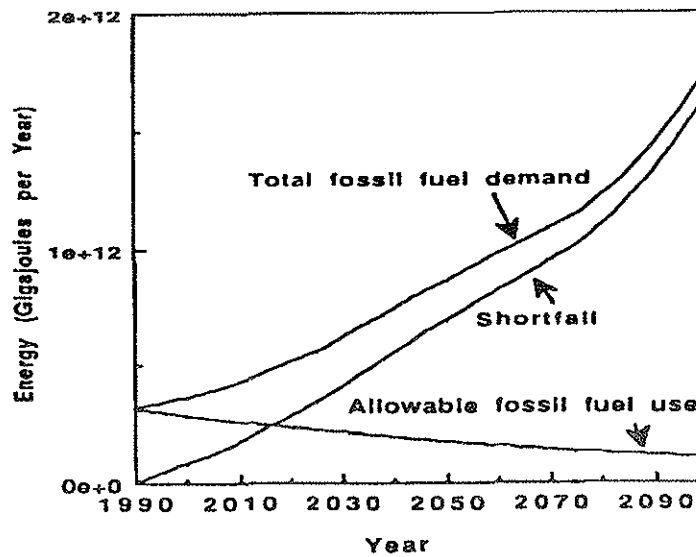

Figure 2.5 Projected World Energy Shortfall

2.1.4 Conclusion

The level of growth in future energy needs as shown in the different models will cause severe problems in terms of finances, resources and pollution. The energy available is inadequate for the projected needs, even in the low growth scenarios. It is difficult to foresee terrestrial renewable energy sources that can provide enough energy without causing serious environmental problems. One alternative technology could be space based solar power which is an inexhaustible source of clean and safe energy. Solar space power could probably eliminate all restrictions and limits of future growth.

In our opinion the future energy usage model by Lomer seems to be a realistic projection. It gives a high and low case for future energy consumption until 2100. The assumptions for this model are not restrictive in terms of economic growth with respect to the developing and developed countries. This model comes to the conclusion that there will be a 2.5 to 5 fold increase of the current energy consumption by 2100.

The model of Dessus and Pharabod is in fact very optimistic. Compared to the different scenarios described in the energy demand model by Lomer, the projections for future energy demand by 2100 in the Dessus/Pharabod model are even below the estimated range of 17-50 TWy/year predicted in the previous model. [Lomer 91, Deschamps, 1992] Hence this model does not seem to be very reasonable to us.

The carbon cycle model of Edmonds and Reilly shows also a high future energy demand in 2100 and clearly indicates the need for other energy sources than fossil fuel or atomic energy. Power from space could be one of the options for safe and clean energy. From the environmental standpoint of view space solar power seems to be a very reasonable energy form for covering the increasing future energy needs of the world.

2.2 Terrestrial Energy Supply

The previous section addressed the question of how much energy may be needed in the future and what it will be used for. The actual amount of energy actually provided will depend on a variety of factors including production cost, available supply, and other market related issues. Section 3.2.4 will address the relationship between supply and demand and will discuss market characteristics that influence pricing and energy availability. This section will be concerned with the question of *how* energy needs will be provided. The following subsections include a description of the various sources of energy and their characteristics, the conversion processes for the major uses of energy, and the cost (present and future projections) of providing energy from each source. The major goals of this section are to provide a realistic basis for evaluation of future energy sources and to establish a cost target for the space solar power program to determine the circumstances under which it will be cost effective.

2.2.1 Energy Sources

A brief definition of terminology that will be used throughout this section will help the reader understand the ensuing discussions. Primary energy refers to energy that is used and converted directly by an end user. Secondary energy refers to energy that has gone through a previous conversion process before it reaches the end user (e.g. electricity generated at a power plant that then goes to your house). Three categories are used for classification of primary energy sources.

- (1) Fossil Fuels (oil, coal, gas): organic matter subjected to high temperature and pressure were formed by natural processes on a geological time scale. Energy contained in fossil fuels is usually released by burning.
- (2) Nuclear (fission, fusion): when atomic nuclei decay or combine they produce high energy particles which can sustain a chain reaction. Heat produced by these processes is captured and used to produce electricity.
- (3) Renewable (solar, biomass, wind, tidal, river, geothermal): the forces of nature can be harnessed as energy sources. Radiation from the sun can be a heat source or can drive photovoltaic energy conversion. Biomass accumulates solar energy in the form of plant matter using photosynthesis. Plants can provide several different sources of energy; oil produced by plants such as sunflowers or soybeans, alcohol produced by fermentation of plant material, or simply the plant material itself which can be burned. The heating and cooling of the global atmosphere generates wind that can be used to drive a wind turbine. Interactions with the moon, sun and other planets cause movement of the liquid surface of our planet. This kinetic energy, as well as that of flowing rivers, can be used to drive generators. And lastly, the internal energy of the Earth's magma comes close enough to the surface in places so that we can tap this natural heat source.

The current world energy supplied by each category is: Fossil Fuels provide 90% (coal; 30%, oil; 40%, gas; 20%), Nuclear 5%, and Renewables about 5% (hydroelectric provides most of this with a negligible contribution from solar, wind, etc.). [Sci. Amer., 1990]

Characteristics of primary energy sources vary greatly and can have a significant effect on suitability for satisfying particular energy needs. Two broad categories of characteristics will be discussed. The first are inherent properties of the energy source and include physical properties (e.g. energy density), storability and future availability. Table 2.1 summarizes the inherent characteristics of primary energy sources. The future availability estimates are for depletable (fossil fuel and nuclear) and continuous (renewable) supplies. [Scientific American Inc., 1971] Depletable reserves are an estimate of the quantities available at no more than twice present costs. In general, fossil fuels have high energy density, are easily stored and have finite reserves which will be exhausted at some point in the future depending upon use rates. Nuclear power has the highest energy density per mass, is storable with special handling requirements and also has finite, exhaustible reserves. Renewable energy sources are usually low density, are dynamic sources and therefore not storable, but are inexhaustible as long as the sun continues to shine and the Earth continues to exist. The value given in the table for solar energy, which is an enormous amount of energy, is only for the fraction that falls on land. If the solar energy falling on a few percent of the land area in the U.S. was converted to electricity at an efficiency of 12%, it would satisfy most of the countries energy needs in the year 2000.

The second category includes those characteristics which are related to energy production, such as resource location compared to point of use location and potential environmental impact. Fossil fuels are found in discrete locations and require transportation to use point locations. It is significant that resource locations are within national boundaries and are therefore available to outsiders at the discretion of the controlling country. Since energy is released from fossil fuels by burning, there are corresponding environmental consequences. Also, the mining and transportation of fossil fuels can have a serious impact on the environment. Nuclear fuel is found in discrete locations, must be transported to processing and use point locations, requires very controlled and complete processing to be useful, and has potential environmental impact which has caused significant public concern. Safety regulations and strict adherence to established operating procedures minimize the potential of nuclear accidents, but the question of safe disposal of radioactive waste is still unresolved. All of the renewable energy sources, except solar, have restricted appropriate locations which are often not near population (and therefore energy use) areas. Environmental impact tends to be a disruption of natural ecosystems rather than atmosphere contamination. Table 2.2 provides a summary of characteristics which will influence choice of energy source, operation of energy production facilities, and ultimately the cost of energy.

Table 2.1 Inherent Characteristics of Primary Energy Sources

ENERGY SOURCE	PHYSICAL PROPERTIES	STORABILITY	FUTURE AVAILABILITY
Fossil Fuels:			
Oil	<ul style="list-style-type: none"> • liquid form with different grades • refining required to separate grades • heat of combustion = 4.3×10^7 J/kg 	<ul style="list-style-type: none"> • easily stored, • infrastructure (tanks) needed • monitoring required 	<ul style="list-style-type: none"> • finite resources; 100-200 (10^{12} Watt-Yrs) • recovery from shale oil and tars increasingly expensive
Gas	<ul style="list-style-type: none"> • low density gas • energy content similar to oil 	<ul style="list-style-type: none"> • easily stored • large volume tanks with safety monitoring (esp. for leaks) 	<ul style="list-style-type: none"> • finite reserves ; 70-170 (10^{12} Watt-Yrs)
Coal	<ul style="list-style-type: none"> • solid with variable composition (esp. sulfur content) • heat of combustion = 3.0×10^7 J/kg 	<ul style="list-style-type: none"> • easily stored with little infrastructure (it can be stored in piles outdoors) 	<ul style="list-style-type: none"> • large reserves of varying quality; 670-1000 (10^{12} Watt-Yrs)
Nuclear:			
Fission	<ul style="list-style-type: none"> • Heat production from Uranium₂₃₈ = 8.1×10^{13} J/kg 	<ul style="list-style-type: none"> • special handling and storage procedures 	<ul style="list-style-type: none"> • significant quantities in small number of places; 3000 (10^{12} Watt-Yrs)
Fusion	<ul style="list-style-type: none"> • very high energy content 	<ul style="list-style-type: none"> • prepared fuel easily stored in tanks 	<ul style="list-style-type: none"> • technology currently unavailable • possibly long duration source
Renewable:			
Solar	<ul style="list-style-type: none"> • approx. 1.0 kW/m^2 at sea level during clear days • clouds seriously reduce availability 	<ul style="list-style-type: none"> • not storable, external devices (e.g. batteries) needed, usually with significant reduction in efficiency 	<ul style="list-style-type: none"> • the sun will continue to burn for 5-10 billion years • solar radiation falling continuously on Earth's land area; 28,000 (10^{12} Watts)
Biomass	<ul style="list-style-type: none"> • variable composition and energy content (oil, alcohol, plant material) • low energy density 	<ul style="list-style-type: none"> • infrastructure required • oil and alcohol stored in tanks, dry plant matter in bins or silos with monitoring 	<ul style="list-style-type: none"> • indefinite as long as land, water, and sun are available; world max. supply; 13 (10^{12} Watts)

Table 2.1 (continued) Inherent Characteristics of Primary Energy Sources

ENERGY SOURCE	PHYSICAL PROPERTIES	STORABILITY	FUTURE AVAILABILITY
Biomass	<ul style="list-style-type: none"> • variable composition and energy content (oil, alcohol, plant material) • low energy density 	<ul style="list-style-type: none"> • infrastructure required • oil and alcohol stored in tanks, dry plant matter in bins or silos with monitoring 	<ul style="list-style-type: none"> • indefinite as long as land, water, and sun are available; world max. supply; 13 (10^{12} Watts)
Water (tidal,hydro)	<ul style="list-style-type: none"> • energy content depends on kinetic or potential energy content 	<ul style="list-style-type: none"> • reservoirs can be used to store energy for release later 	<ul style="list-style-type: none"> • finite suitable locations limit potential; world max. supply; 4.0 (10^{12} Watts)
Geothermal	<ul style="list-style-type: none"> • energy content determined by temperature and pressure 	<ul style="list-style-type: none"> • continuous supply available at resource site 	<ul style="list-style-type: none"> • finite suitable locations limit potential; world max. supply; 0.06 (10^{12} Watts)
Wind	<ul style="list-style-type: none"> • energy content and availability function of wind velocity 	<ul style="list-style-type: none"> • not storable, external devices (e.g. batteries) needed, usually with significant reduction in efficiency 	<ul style="list-style-type: none"> • finite suitable locations limit potential; world max supply; 0.1 (10^{12} Watts) • major technical difficulties with large scale applications

Table 2.2 Operational Considerations Imposed by Different Energy Sources

ENERGY SOURCES	LOCATION	ENVIRONMENTAL IMPACT
Fossil Fuels:		
Oil	<ul style="list-style-type: none"> • discrete source locations, • transportation to use point is required, usually by tanker or pipeline 	<ul style="list-style-type: none"> • burning produces air contaminants, especially carbon dioxide which contribute to the greenhouse effect • transportation by sea may result in oil spills • pipeline construction disturbs natural ecosystems and can interfere with migration • fire hazard at production and storage sites with resulting loss of property and land and air pollution
Gas	<ul style="list-style-type: none"> • discrete source locations, • transportation to use point is required, usually by pipeline 	<ul style="list-style-type: none"> • fairly "clean" energy source, burning produces mainly carbon dioxide and water • pipeline construction disturbs natural ecosystems and can interfere with migration • serious fire hazard at production and storage sites with resulting loss of property and land and air pollution
Coal	<ul style="list-style-type: none"> • discrete source locations, • transportation to use point is required, usually by railroad or boat 	<ul style="list-style-type: none"> • burning produces air contaminants (carbon dioxide and sulfur) which contribute to the greenhouse effect and acid rain • concentration of heavy metals in ash • mining disturbs natural ecosystems (especially strip mining) and can produce hazardous conditions for workers and surrounding communities
Nuclear:		
Fission	<ul style="list-style-type: none"> • fuel found at discrete locations • requires transportation to use point and special handling for worker safety as well as security reasons 	<ul style="list-style-type: none"> • risk of accidental release of radioactivity to atmosphere during electricity production • waste material is highly radioactive and must be contained for decades • risk of diversion of fissile material to bombs
Fusion	<ul style="list-style-type: none"> • fuel can be produced near use point 	<ul style="list-style-type: none"> • radioactive equipment due to operation will need special storage
Renewable:		
Solar	<ul style="list-style-type: none"> • everywhere on Earth, source and use location are usually the same • low density distribution not well correlated to area of use; may require distribution 	<ul style="list-style-type: none"> • large arrays may effect natural ecosystems • no impact on atmosphere • manufacturing of solar cells produces toxic waste

Table 2.2 (continued) Operational Considerations Imposed by Different Energy Sources

ENERGY SOURCES	LOCATION	ENVIRONMENTAL IMPACT
Biomass	<ul style="list-style-type: none"> • anywhere land, water and sun are available (in competition with wildlife and people) • requires transportation to use point 	<ul style="list-style-type: none"> • burning produces air contaminants (especially carbon dioxide) • no net production of carbon dioxide (amount released during energy production is equal to amount absorbed during plant growth) • fire hazard at storage sites with resulting loss of property and air pollution
Water (tidal,river)	<ul style="list-style-type: none"> • discrete locations, often far away from population areas • may require distribution 	<ul style="list-style-type: none"> • very clean, no effect on atmosphere • damming or diverting rivers and interfering with tidal flow may alter or destroy ecosystems • risk of collapse of dams resulting in loss of life (human, livestock, wildlife) and property
Geothermal	<ul style="list-style-type: none"> • easily accessible at discrete locations, often far away from population areas • may require distribution 	<ul style="list-style-type: none"> • very clean, minor effect on atmosphere (release of sulfur?)
Wind	<ul style="list-style-type: none"> • discrete locations, often far away from population areas • may require distribution 	<ul style="list-style-type: none"> • very clean, no effect on atmosphere • local noise • unsightly ("eyesore")

It is clear that each energy source has its advantages and disadvantages. Fossil fuels have high energy density and good storage characteristics. However, their future availability is uncertain (partly because of finite resources but also because of resource location) and their environmental impact is becoming more and more of a global concern. Nuclear fuel energy density is very high but safety and environmental impact considerations (both real and perceived) may be prohibitive. Renewable energy sources are attractive because of their low environmental impact (at least for humans, if not for wildlife) and continually available supply. However, the restricted availability of suitable locations for hydroelectric, geothermal, and wind imposes a severe limit to their future contribution. Also, low energy density and difficulty with storage make them impractical for certain applications. These characteristics and the inconvenient location of some renewable energy sources (i.e. far away from heavy use areas) may provide a market for Earth to Earth relay satellites to distribute power to areas that need it. Of all the energy sources, solar energy is the most attractive option in terms of general availability since it is accessible anywhere on Earth (depending on variation in cloud cover) has the lowest potential environmental impact, and a virtually inexhaustible supply.

The major conclusion of this section is that energy sources have markedly different characteristics both physical and operational. Because of these differences they may not be readily interchangeable. It is not enough to determine the amount of energy needed and then to allocate a certain percentage of the energy requirement to a particular energy source based on its energy content. The best example of non-interchangeability is fuel for transportation. Current types of automobiles use varying grades of oil. It is true that other sources of energy can be used to power cars but significant changes in automobile technology would be required to accommodate them. Another aspect of differences in characteristics is the variable cost of collection, transportation, environmental cleanup and storage requirements. For example, when considering biomass as an energy source, the energy and labor cost of collection and transport to use location must be weighed against its inherent energy content. Section 2.2.2 will discuss the different types of conversion and will help illustrate why certain types of energy sources are more appropriate for specific conversion processes. Section 2.2.3 will provide current energy costs and projected costs (where available), and a discussion of how the characteristics described in this section contribute to the cost of energy. In the final analysis, economics will dictate which types of energy sources, and also how much energy, will be used in the future.

2.2.2 Major Uses and Conversion of Primary Energy

The section above described the different energy sources. Their energy has to be transformed into the service needed. Usually there are several possibilities to deliver a certain service (e.g., electric heating versus coal heating). A possible subdivision of the different services (transportation, electricity production and direct heat production) is done in the following three subsections with a special emphasis is on the different transformation processes. This section describes how primary energy is transformed into secondary energy. Secondary energy (in contrast to primary energy) is defined as energy in such a state that it can be transformed easily (without big conversion losses) into the energy form required. The two most important forms of secondary energy dealt with here are electric energy and mechanical energy.

Transportation

In 1991, transportation accounted for 42% of the fossil fuel consumption in USA (Figure 2.2). For all transportation systems, energy is mainly required to generate movement. This form of energy is called kinetic energy or mechanical energy. Other forms of energy that are employed on board the vehicle (light, cooling, heating ...) are usually small compared to the kinetic energy demand and will be neglected here.

A major feature of mobile systems is that all (or most) parts of the energy system are moving with the vehicle. That requires them to have certain limitations in terms of weight, size, security in case of accidents, mechanical stability, etc.

For many means of transportation the energy supply is the limiting factor. Therefore this section will be subdivided further into three forms of energy supply: vehicles with external energy supply, vehicles with direct conversion and vehicles with internal energy storage.

Vehicles with External Energy Supply

Such vehicles do not carry their internal energy source. Usually the energy is delivered from a stationary facility. There are different principles used to deliver different forms of energy to the vehicle like:

- Electric energy can be delivered using power lines or electrified rails (e.g. at trains, subways, streetcars, power line busses).
- Electric energy might be delivered using microwave transmission (future applications might be airplanes and electric propelled rockets/satellites).
- Mechanical energy can be delivered using transmission strings (cable cars, cable boats).
- Mechanical energy can be delivered by magnetic fields (e.g. for future magnetic levitation subways and trains).

The conversion process at the above vehicles will not be discussed in further detail because they use already secondary energy as input. The conversion therefore is dealt with in the section Electricity Production.

Variations in the market shares of vehicles with external power source influence the overall energy structure. Since these vehicles are primarily used in public transportation, the development of the market shares in public transportation (versus individual transportation) is an essential figure. This figure therefore has influence on the form of energy used and on the amount of energy. For the time being, the development of market shares is different in different geographic areas. Generally the market share in urban areas of industrialized countries is rising, whereas it is dropping in threshold countries and remains on its current level in developing countries.

Vehicles with Direct Conversion

These vehicles do not have an energy storage system because they transfer energy collected from outside (= external energy) into the required kinetic energy. Since nowadays market share is limited and does not seem to increase significantly in future, only a short description of wind and solar energy use will be given.

Wind powered vehicles have a long tradition. Examples are sailing boats, balloons and gliders. For about 30 years there have been research projects to develop big wind powered freight ships (based on the Magnus effect). Also research projects deal with new forms of application of wind gradients for freight airplanes (albatross flight).

Solar powered vehicles usually use solar cells to generate electric power from sunlight. Typical applications are solar powered cars, boats, satellites and airplanes. Since solar powered cars, usually can not be operated without sunlight it appears to be more a sports toy (electric powered cars will be described later). For airplanes that have to stay for a long time at a high altitude (e.g., for broadcasting and for remote sensing) solar power supply is an interesting option.

It is also possible to convert the photons' impulse directly into the propelling force or to use the solar wind in space. Due to limited application, these options will not be discussed further.

Vehicles with their Own Internal Energy Storage

This section describes the most common present transportation systems. As mentioned before the most important features of the energy storage systems are their weight and volume. Also the recharging (or refueling) process should be easy and fast. The vehicles' energy sources are subdivided here into chemical, electrical and nuclear.

Chemical storage is mostly done by liquid fuel. Cars for individual transportation contribute most to the overall traffic use. Nowadays they are usually propelled by petrol (and sometimes diesel). Petrol has a high energy content, is (in case of an accident) relatively safe and is easy to handle. Also the petrol distribution system is very well developed.

The engine technology is well developed and is usually based on a combustion process inside a cylinder. A moveable piston is transferring the combustion process energy into mechanical energy. Since many dynamic processes take place simultaneously inside the cylinder, not all performance parameters of the engine can be optimized independently. This is especially a problem in terms of the reduction of the various exhaust gases. This makes the environmental issue quite challenging (especially in urban areas). In many industrialized countries there is therefore a strong political

pressure towards exhaust reduction (like nitrogen oxide, sulfur, carbon monoxide, carbon hydrogen and lead). Also the problem of overall energy consumption is being addressed.

Modern technology such as electronic motor management and catalytic converters so far achieved major improvements. In terms of carbon dioxide generation, however no good solutions have been found.

The usage of petrol is becoming more difficult. Therefore much effort is underway to replace petrol with the following liquid fuels:

- **Liquid gas:** it is mainly considered because natural gas supply is more abundant than oil.
- **Regenerative fuel (biological alcohol and gas):** regenerative fuel is a renewable form of energy. Therefore it can not run out ever though the total amount of power is limited by the available production area. Regenerative fuels also produce exhaust, but it is not increasing the amount of carbon dioxide in the atmosphere.
- **Liquid hydrogen:** since it is mainly produced by electrolyzing water, the future availability is limited by the availability of electric energy. This fuel does not increase the amount of carbon dioxide in the atmosphere. Hydrogen can be used to generate electric power directly by fuel cells. Since hydrogen is difficult to store and transport, its use is subject to many research projects. A special focus is in generating hydrogen from solar electric power collected at remote sites around the equator. Major problems are the limited efficiency rate of the electrolysis (70%) and its price.

Solid fuel like coal and wood are another form of chemical storage. Because it is difficult to handle, solid fuels are not used for smaller vehicles. Traditionally they are used for trains and ships. The uses of solid fuel for transportation seem to become less important.

Electric energy storage in batteries is another form of chemical storage. At the beginning of the automobile age, battery powered cars had an important market share. Until now, attempts to bring them back to the market have not been very successful. With the increasing importance of energy saving and environmental protection this might change. So far the main problem to build electric cars with acceptable performance is the low energy content of batteries in respect to its weight. This limits the driving range of cars to about 100 km. Also much time needed to recharge an empty battery, so it might be better to exchange the battery as a whole. So far the near term market might be limited to small cars ("city cars"). To overcome the above limitations, the so called hybrid car is under development. It uses a combination of an electric and a petrol engine. While the electric engine is sufficient for short and slow trips (city traffic), the petrol engine improves the range and (horse)power performance of the car.

Nuclear power offers an excellent ratio between mass and power density. However because of system size, security reasons and costs such systems are confined to ships, submarines and space vehicles. Plans to build nuclear powered airplanes have been abandoned. Additionally to the military ships and air carriers there are also civil examples of nuclear powered freighters and icebreakers. However the future development in the civil sector seems to be uncertain.

Electricity Production

Electric energy is form of energy that can be transformed best into most other forms of energy. It is for example possible to transform it with very low loss into mechanical or heat energy. Moreover its market share in future seems to increase. Therefore electric energy systems can be used as a reference for the comparison of different energy systems.

In this chapter the different principles of electric generation will be discussed first, then the typical features of generators will be evaluated.

Most of nowadays electric power stations first transform the primary energy into mechanical energy (= rotation). Using electric generators the rotation is finally transformed into electric power.

Dynamic Electric Conversion (Electric Generator)

The technology of generators is well developed and is already existing for about 100 years. Generally in a generator a magnetic field generates electricity in rotating coils that are mounted on the generator's axis. Big generators deliver up to 1 GW of electric power and have a conversion rate of up to 99.5%. Also small generators that generate only a few kW of power have efficiency rates of more than 90%.

The mechanical rotation can be generated directly from the primary energy (e.g. hydroelectric, windmill) or by using a thermodynamic conversion (e.g., turbine). In the following the different principles of rotation generation are described (direct dynamic conversion, thermodynamic conversion, direct conversion).

Direct dynamic conversion uses primary energy that is already available in the kinetic form. Normally the direct conversion process into rotation is usually chosen. The following sources are mainly used:

- **Wind energy:** usually horizontal or vertical wind propellers are used. Horizontal propellers have a higher efficiency rate, but they have to be oriented into the changing wind direction. Since this is not necessary for vertical axis rotators their design is much simpler. Therefore they are used more and more despite their lower efficiency. Main problems with wind generation are the high investment per installed power and the variations of wind speed. Moreover only certain areas have sufficient wind speed. However wind electricity generation is considered to have a large future potential.
- **Hydroelectric power (hydraulic turbine):** dependent on the water pressure and volume different principles are used. Usually a water stream or ray is used to propel shovels that are mounted on the turbine's axis. Efficiency rates are about 90%. Hydroelectricity can be subdivided into reservoir power stations and river water power stations. Whereas the later delivers energy on a constant basis (dependent on the season), reservoir stations can deliver power on request. This makes them an interesting part of a power grid. Moreover hydroelectric power stations are used to a great extent to store of superfluous electric energy by pumping water uphill. Hydroelectric energy is regarded to be a very clean energy. However its use can not be expanded much further because the majority of its potentials is already used. The potentials that have not used yet are mainly located in remote areas (northern Canada and Russia, South America). Improvements in electric energy transportation (high voltage DC transmission, power relay satellites, super conductive power lines, hydrogen) could change that situation.

Thermo dynamic conversion is the process that converts thermal energy into kinematic energy (movement). All major processes use gas expansion. The two main conversion processes are the combustion engine and the gas turbine. The combustion engine is only used in small power stations and was already described in the section "Energy Use in Transportation". The gas turbine transfers the expansion of heated gas (usually water vapor) into kinetic energy. In contrast to the combustion engine the combustion process and the kinetic transformation are locally separated. This allows more control on the burning process. Therefore the efficiency rate is higher and less undesired exhaust is produced. In many countries laws enforce the additional treatment of the exhaust by filters and spray washing. In 1990 an exhaust reduction of sulfur and nitrogen oxide down to 20% and more can be achieved. Since the additional investment for the coal power station accounts for about 30% of the overall costs, exhaust treatment might not be implemented in threshold and developing countries.

The efficiency rate of thermodynamic processes depends on the temperature difference the gas is undergoing in the expansion process and is theoretically limited by the law of Carnot. In modern power stations rates of 40% are achieved. The remaining 60% of the fuel energy is transferred into heat that warms up the area surrounding the power station (especially the river). The impact of a big power station on micro climate can be considerable. It is possible to use the abundant heat for remote heating of buildings. Due to the high cost this is usually not done yet. Also the heat can be used for industrial processes. Unfortunately the high temperature usually required reduces the efficiency rate of the electric conversion.

Thermodynamic generation of electric energy can be used in combination with fossil energy (oil, coal, gas), nuclear energy, geothermal energy and solar energy. While fossil energy is limited and the political future of nuclear energy is unclear, a main difficulty in the usage of geothermal and solar energy is the small temperature difference. Instead of using the turbine principle, the Stirling motor (or similar devices) is applied. Energy generation is more costly for systems based on small temperature differences since less power is produced for a given amount of equipment. This makes geothermal energy production cost effective at only a few locations. To reach high temperature differences with solar energy, effective concentrators (mirrors, etc.) need to be used. This requires a mechanism to follow the changing elevation and azimuth of the sun. This mechanism is the main cost driver in current experimental thermodynamic solar power stations.

Direct conversion principles are now under development to overcome the main problems of thermodynamic conversion. Principles discussed here are photovoltaic, thermoelectric conversion, magneto-hydraulic and chemo-electric:

- Photovoltaic conversion: it is usually based on semiconductive crystals (silicon, gallium arsenide, cadmium sulfide, etc.) that convert sunlight directly into electricity. Since they are one major component of space solar power stations they are described in the power chapter of this report. Main problem of photovoltaic conversion is the high price for the solar cells. However a potential of significant cost reduction exists.
- Thermoelectric conversion: it is based on the different velocities of charge carriers at a junction between two different metals or semiconductors (the Seebeck effect, also known as inverse Peltier-Effect). With current materials the efficiency rates achieved are lower than for thermodynamic conversion. Since the converter is quite simple, it is often applied for small nuclear power generators in space.
- Magneto hydraulic generator: it transforms the kinetic energy of a fluid or gas into electricity without using mechanical parts. Its principle is based on the induction of voltage in the fast gas flow under the presence of a strong magnetic field. To get the maximum amount of electric power, the gas must have a high velocity (generated by thermal expansion) and a low electrical resistance. In combination with gas turbines efficiency rates of 50% and more are reached at Russian experimental plants. Even though this technology is expensive it is likely that it will be used in future thermodynamic power stations.
- Chemo-electric (fuel cells): they are built quite similar to an electric battery. They transfer the chemical energy of the fuel directly into electricity. The technology to convert hydrogen and oxygen into water and electric energy is most developed, but it is also demonstrated that oil products can be used. Nowadays fuel cells are mainly used to generate electricity for vehicles (also in space). A future application is the usage of hydrogen for transportation and storage of energy.

Features of Electric Generators

To describe a whole energy supply system, many features of the power source have to be taken into account. These features are often dependent on daytime, season, locations of the power sources, etc. Moreover the way the different power sources in a power grid fit together might be a non-linear function. This means that a power grid should be described in terms of a non-linear equation system. Based on this the optimal combination of power sources can be derived. Due to the complexity of such an approach, a much simpler model is being used here. It is based on the following three assumptions:

- The cost of the power source is not included (this factor is described in the financing chapter).
- The 3 main features we have taken into account are: Peak power performance (**P**), Local availability (**L**) and Mobility (**M**). The parameter **P** describes how well the power source can provide additional power on request and how predictable its delivery is.
- A number between 0 and 10 is allocated to all the above features. Larger numbers represent advantages.

Only two power sources are compared with each other to keep the complexity low. However, for a more precise evaluation the interaction of all power sources used must be considered.

A measure for how good two power sources complement each other has been established. We have called it "Value of Combination" (**VOC**). This factor compares two different power sources. It is a combination of the aforementioned features (its value is between 0 and 10). Higher values indicate bigger differences between the power sources that corresponds to a better combination. The formula for **VOC** is arbitrarily defined as a linear combination of **P**, **L** & **M**. The formula is based on the assumption that the highest priority for the combination lies in **P**. The weighting of the different factors depends of the type of power grid. The numbers chosen here might be typical for a large power grid. Figure 2.6 shows the features for different classes of power generators and the **VOC** between them. A possible feature (that needs to be evaluated further) of a geostationary solar power satellite is its high mobility in terms of power delivery. A few hours after a distress (e.g., a typhoon) a deployable rectenna could be brought to the location and set up for medium size emergency power (e.g., for a hospital). To get the power to the site, only the power satellite's microwave beam must be directed towards the location. If a higher power demand has to be fulfilled, a large rectenna can be installed (the installation of a large rectenna requires much less time than the construction of a power plant). The figure below demonstrates the big differences in the way different power sources complement each other. Under the above assumptions the figure shows that fossil fuel, hydroelectric and biomass power complements best with a solar power station in an equatorial low earth orbit. A

solar power station in an inclined low earth orbit can be complemented best with hydroelectric energy. For a solar power station in geostationary orbit again hydroelectric energy fits best.

$$VOC = 0.6 \times |P1-P2| + 0.3 \times |L1-L2| + 0.1 \times |M1-M2|$$

	P Peak perf.	L Local Avail.	M Mo- bilty	SSP in equ. LEO	SSP in incl LEO	SSP in Geostat Orbit	Fossil Fuels	Nuc. Fiss. Fus.	Hydro Electr.	Tidal	Wind + Wave	Earth Solar	Bio- mass	Geo- ther- mal
SSP in equatorial LEO	1	0	1	-	2	4	6	4	6	0	1	1	6	2
SSP in inclined LEO	1	6	7	2	-	2	5	3	8	3	2	2	5	3
SSP in GEO	3	7	10	4	2	-	4	2	7	4	4	4	3	3
Fossil Fuels	7	0	5	6	5	4	-	3	5	7	7	7	2	5
Nuc. (Fission+Fusion)	3	10	0	4	3	2	3	-	6	4	6	5	3	3
Hydroelectric	10	1	0	6	8	7	5	6	-	6	6	7	4	4
Tidal energy	1	0	0	0	3	4	7	4	6	-	1	2	6	2
Wind + Wave Energy	0	1	3	1	2	4	7	6	6	1	-	0	6	2
Earth Solar Energy	0	2	3	1	2	4	7	5	7	2	0	-	6	2
Biomass	7	7	1	6	5	3	2	3	4	6	6	6	-	4
Geothermal	3	1	0	2	3	3	5	3	4	2	2	2	4	-

Figure 2.6 Assessment of Mix of Power Sources

Direct Heat Production (Non Electric)

Traditionally heat generation is the major and most important use of energy in many regions. In this section only the direct conversion of primary energy into heat is regarded (e.g. not electric heating). Heat energy can be subdivided into room heating and heat for industrial processes. Physically spoken heat is a "low value energy" therefore it can be generated from every form of energy at an efficiency rate of practically 100%. Therefore it is effective to generate heat directly from the primary source instead of conversion with a low efficiency rate in-between. This is the reason it is mainly generated by burning processes of fossil fuels like coal, gas or oil. Solar collectors are finding increasing use for direct heat production. They are water (or liquid) cooled systems and are usually installed on rooftops. Since the output temperatures do not have to be very high for room heating, it is a simple and inexpensive system. This might become the first economical application of solar energy.

The heat conversion can take place at the individual user (house) or centralized. Centralized heating has the following advantages:

- More effort can be put into optimization of the burning process, maintenance of the system and into cleaning of exhaust gasses.
- Expensive technologies can be used like geothermal energy, garbage burning, coupling with electricity production or even decentralized nuclear heat production.

Remote heating systems use thermal insulated pipe systems to distribute the heat to the user. The disadvantages of remote heat stem are the high cost of the pipe system and its high energy losses for long pipes (in East Germany these losses accounted to 40% to 50%). In regions where electric power is available in abundance electric heating for houses is used to a large extent.

2.2.3 Cost of Terrestrial Energy

This section provides a cost target for evaluating the economic viability of the space solar power program. It will be a moving target because the price of energy will change as energy resources become depleted, world energy demand increases, and world politics change. The absolute upper bound to terrestrial energy costs can be determined by estimating the cost of energy in a hydrogen energy economy with virtually unlimited supply. This scenario assumes hydrogen is produced by steam refining of methane, electrolysis of water, or refining methanol using solar energy. Current cost of 70,000 standard cubic feet of gaseous hydrogen is \$15k using conventional energy sources for production. Solar energy is currently about twice as expensive so a projected cost of \$30k per 70,000

standard cubic feet is used. An order of magnitude estimate of this upper limit based on solar powered production costs and energy content of gaseous hydrogen (342 BTU/standard cubic feet) yields a cost of \$4.28/kWh. [Brandhorst, 1992] If future energy sources ever come close to the hydrogen cost limit, they will cease to be used unless other factors make them more appropriate than hydrogen for a particular application. The lower end of the energy cost range can be approximated by current energy sources. For example, the current cost of electricity using coal is approximately \$0.07/kWh, which is roughly two orders of magnitude below this upper limit. Having established the upper and lower bounds for energy costs, the following paragraphs will present an overview of current and projected energy costs (where available) and a brief discussion of the factors which may influence the cost of energy in the future.

A considerable amount of work has been done in past solar power projects to try to estimate future energy costs. Table 2.3 gives quantitative projected costs for the *delivered* cost of fossil fuels in a future scenario considered as "the most probable case" in a report prepared by Argonne National Laboratory. [ANL/EES-TM-120, 1980] These results show the cost of coal, oil, and gas rising two to four times in the next 40 years.

Recent trends for photovoltaic energy production show the opposite with costs decreasing from \$60.00 in 1970, to \$1.00 in 1980, and to the current cost of \$0.30/kWh. [Sci. Am, 1990, pp147] Other current cost estimates for renewable energy sources are wind at \$0.07-0.12/kWh and hydroelectric at \$0.05-0.10/kWh. Because of their limited contribution to supplying future energy demand, cost projections for these sources are not discussed here. Predicting the cost of future energy must consider production cost as well as market conditions. This section will discuss, in some detail, the factors which contribute to production cost. There is also a brief mention of supply and demand relationships which will be developed further in Chapter 3.

The major factors that influence production cost are mining, transportation, type of conversion process, and environmental constraints (including nuclear safety considerations). As easily accessible resources are depleted, the cost of mining other available sources (e.g. oil from shale or tar) will increase. The technologies for transportation and energy conversion are well established and costs should remain fairly stable. However, since mining, transportation, and energy conversion all require a power source, as energy costs increase it will also become more expensive to produce.

Table 2.3 Delivered Fossil Fuel Prices, 1978\$/kWh

Year	Oil	Gas	Coal
1980	\$0.02	\$0.008	\$0.004
1985	\$0.022	\$0.012	\$0.005
1990	\$0.022	\$0.016	\$0.006
2000	\$0.025	\$0.022	\$0.007
2010	\$0.028	\$0.024	\$0.009
2025	\$0.033	\$0.027	\$0.012
2030	\$0.034	\$0.028	\$0.013

Figure 2.7 shows the sequence of operations between the discovery of an energy source and conversion. [Scientific american, Inc. 1971] The type of conversion can be any of those discussed in the previous section and allows comparison between the various energy sources. In the figure, "preliminary conversion" refers to production of intermediate products (such as various grades of fuel from crude oil) which are usually more easily stored or transported for final use. The energy forms indicated are Latent (L) for nuclear and fossil fuel sources, Potential (P) and Kinetic (K) for water sources, including tidal and hydroelectric, Radiant (R) for solar energy, and both Latent and Thermal (T) for geothermal energy. The presence or absence of a dot in each of the "operation" boxes illustrates the impact of some of the characteristics described in Table 2.1 (storability) and Table 2.2 (location). The number of steps to a particular operation, such as "store" or "transport", provides information about how easily adaptable a particular energy source is to a given application. As mentioned earlier, because of their different characteristics, energy sources may not be readily interchangeable. Each of the operational sequences represented in this figure requires supporting

infrastructure peculiar to that sequence and fuel type. Switching from one fuel type to another implies discontinuing use of one set of infrastructure and increased load on the alternative, with associated cost impact.

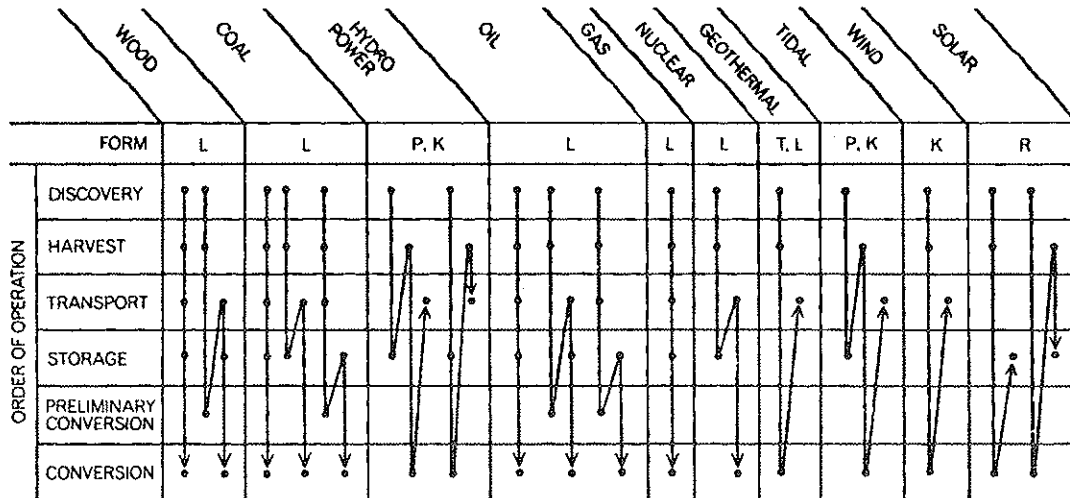

Figure 2.7 Sequence of Operations for Primary Energy Sources

Environmental considerations will become increasingly important, especially in light of today's concern about the effect of carbon dioxide emissions on the Earth's climate. A reasonable and sustainable objective is to limit all forms of pollution and injury to the environment to a level that the biosphere can absorb. Regulations which require restoration of mining sites to their original state, restrict quantities and types of allowed air and water contaminants, and make cleanup of accidents mandatory will reveal the true cost of energy. Some energy sources will be more affected than others and there will be a corresponding shift in cost effectiveness.

The other equally important element, which ultimately determines energy cost, is market supply and demand. The projected costs in Table 2.3 showed increases as a function of time based on a single future demand scenario. Changing assumptions about demand will effect these cost estimates. Figure 2.8 gives an example of the relationship between fuel cost and demand, which shows as the energy demand increases, the corresponding cost will also increase. [Scientific American Inc., 1971] The important point is that energy cost is a function of multiple variables. The relevant, qualitative future trends developed so far in this chapter which will need to be considered in the marketing analysis are the following;

- (1) As discussed in 2.2.1, the world demand for energy is expected to continue to rise with the only questions being how fast and in what part of the world.
- (2) estimates of the worlds energy supply are meaningful only as long as they are accessible to those needing energy, but because of the nature of all energy sources (except solar) supply is under the control of the country in which it resides.

Market analysis provides the link between energy demand (developed in section 2.1), availability of energy sources, suitability for particular needs (described in sections 2.2.1 and 2.2.2), and energy cost. This subject is addressed further in Chapter 3.

In conclusion, the major factors which will influence future energy costs are resource accessibility (from both production and international stand points) and environmental constraints. Of course, unpredictable circumstances, such as a major breakthrough in fusion technology or a major nuclear disaster, would also have a significant effect on the direction and cost of future energy development. Random events aside, as accessibility decreases and the pressure for environmental responsibility increases, the cost of conventional energy will continue to rise.

Given expected trends, the characteristics of solar energy will become increasingly attractive: it is equally accessible everywhere on Earth and not subject to international conflicts, the sun is a continuous and reliable source, and environmental impact is minimal. For these reasons, the question regarding the cost effectiveness of solar power is not if, but *when*. As the cost estimates for the space solar power program become more well defined, they can be compared to values developed in this

section. If initial results are not favorable for today's environment, factors effecting energy cost have been identified which may change this outcome in the not so distant future.

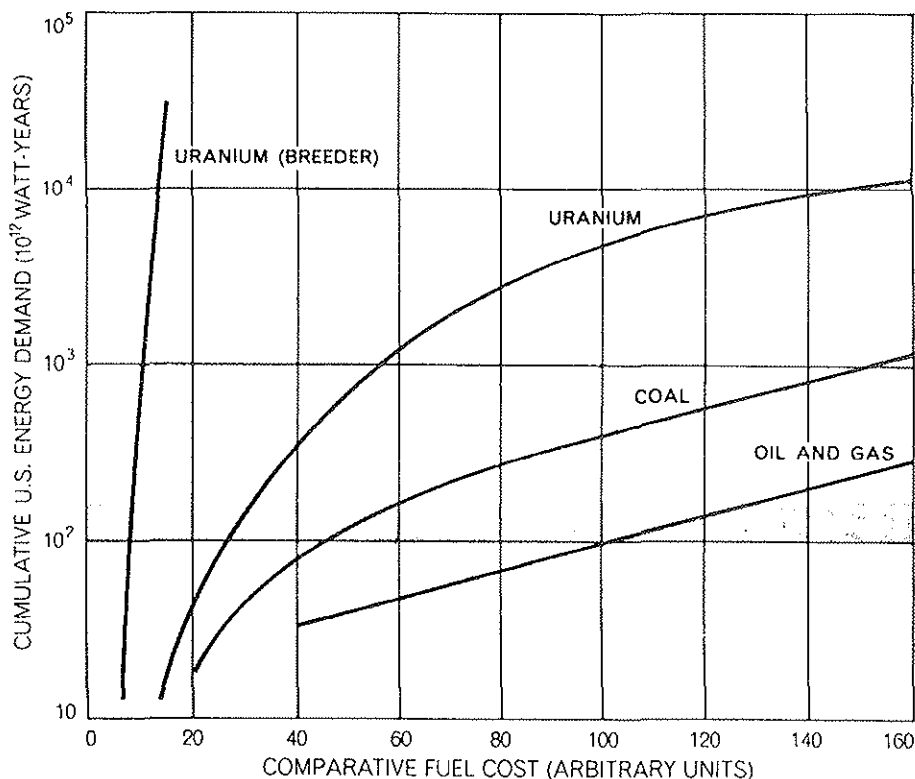

Figure 2.8 Comparative Fuel Costs for Cumulative U.S. Energy Demand

2.3 Space Energy

To fully characterize the status of space power today, we must know what the power is used for, the places where the power is used, and the types of power available to satisfy space energy needs. This includes not only electrical power, but also chemical, thermal and mechanical power. Major uses for space power are for transportation and satellite station keeping. Using typical examples, energy use rates are established for communication and other-purpose satellites. The current populations of satellites are estimated and multiplied by these rates to establish total energy demand in space. And finally, a general discussion of types of space power available to satisfy these needs is presented.

Uses of Energy in Space

In space as on Earth, transportation, or propulsion systems account for the greatest part of energy usage. The vast majority of the space propulsion energy is used in ascending from the Earth's surface to Low Earth Orbit. After this, the propulsion energy used for orbital transfer from LEO to GEO and beyond is the next greatest consumer, and is still an order of magnitude greater than the remaining propulsion needs of present-day spacecraft. For example, the ΔV required for transfer from 200 km LEO at an inclination of 28° is 5.42 km/sec, which means that even when using high- I_{sp} LOX-LH₂ engines 70% of the spacecraft's LEO mass must be devoted to propellant for the transfer. By contrast, a typical satellite might use about 400 m/sec of ΔV over the rest of its lifetime. [Chetty, 1991] Even using a lower I_{sp} monopropellant to provide this energy, only about 5% of the final spacecraft mass need be devoted to propellant for non-launch, non-transfer purposes. This final portion of propellant usage serves several purposes. It is used to make fine corrections to the orbit injection provided by the launch vehicle or transfer stage, for station keeping, for attitude control, and for stability. It also includes extra propellant for contingencies and an additional margin, usually on the order of 10%. Figure 2.9 below shows the propellant usage breakdown for a sample satellite in a 900 km orbit. The values in the pie chart representing the velocity budget (ft/sec) required to maintain a 3000 pound satellite in an 850 km orbit.

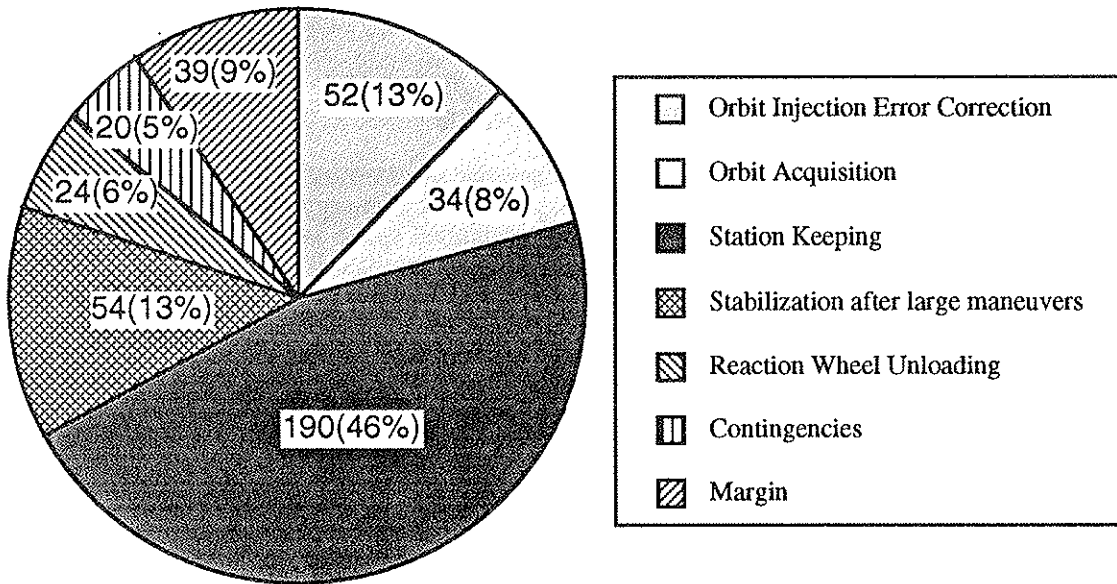

Figure 2.9 Propellant Usage Breakdown for a Sample Satellite in a 900 km Orbit

Power needs in space include command circuitry, thermal control, and general spacecraft maintenance tasks on both manned and unmanned spacecraft. Specific areas include the wiring harness, or power distribution system; mechanisms such as deployment systems for antennae or solar panels; thermal control, both heating and cooling; and TT&C, which includes data storage and transmission as well as command electronics. For manned spacecraft, power usage for life support would also fall into this category. Life support systems introduce additional demands for climate control, lighting, and cleaning and recycling of air and water. On Mir, the only operating manned space station, life support consumes about 1kW of power per crew member out of a total power system of around 25 kW. Figure 2.10 shows the power breakdown for a typical satellite. [Chetty, 1991]

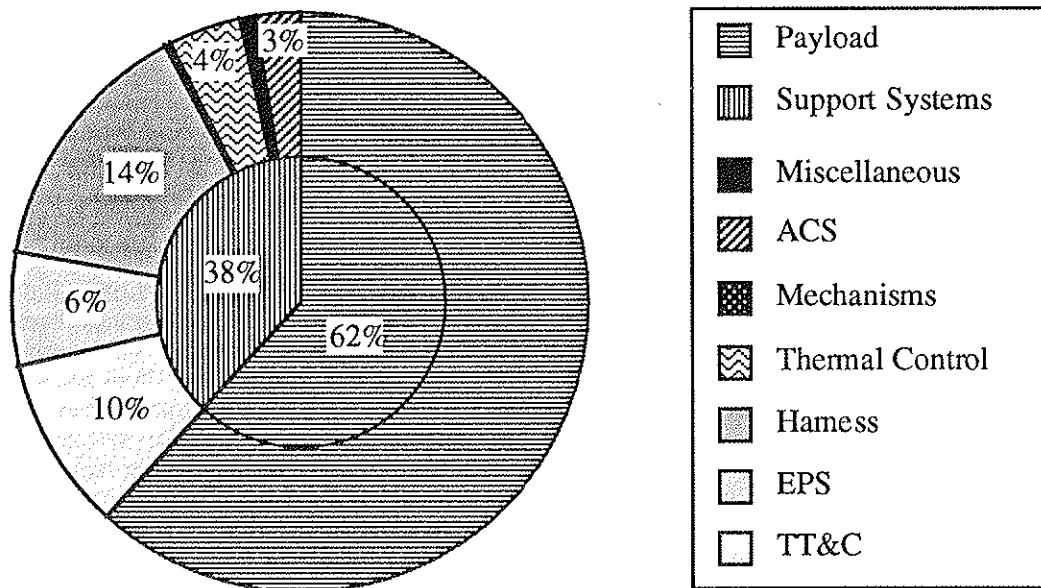

Figure 2.10 Power Breakdown for a Typical Satellite

Satellites, interplanetary probes and information systems applications have similar energy needs. Power is required for sensors and experimental packages, as well as data transmission systems, whether point-to-point, broadcast, or relay. For a small satellite producing a total of about 1 kW of power, experimental payloads might take up 350 W while communications would take up about 100 W. A greater proportion of power would be used for the data transmission systems for commercial communications satellites, where the payload is largely made up of more communications systems.

For unmanned spacecraft in general, power requirements for subsystems of all types come to about twice the power needs of the payload.

Locations of Energy Demand in Space

For the geographical energy demand in space, the number of satellites or other space vehicles at a particular location are counted and then a multiplier for typical energy demand is applied. For the estimation of energy demand of satellites or other unmanned space vehicles, roughly 1.5 kW per communication satellite and 1 kW per each other-purpose satellite is assumed. So daily energy demand becomes 36 kWh per 1 communication satellite and 24 kWh per 1 other-purpose satellite. In the case of manned vehicles, we have to add 1 kW per person for his or her life support. But currently, very few persons are on satellites or vehicles, so we may neglect them.

Trans-atmospheric

In this area, the main energy demands are propulsion. For the estimation of propulsion energy, we calculate the energy of launching a two ton satellite to 1000 km altitude orbit. The initial vehicle has fuel and the total mass is about 100 tons. The velocity of exhaust gas is about 4500 m/s. We can calculate the kinetic energy of the exhaust gas. The kinetic energy of the vehicle is negligible. From this rough estimation, the energy is about 250 MWh. Considering the 350 satellites in operation and the typical mission time (10 years), the energy demand becomes 25 MWh/day. As energies are necessarily concentrated on propulsion, a more meaningful estimate might be based on a typical first stage burn rather than on average energy.

Earth Orbit

Defining low altitude orbit as less than about 5000 km, over 100 satellites are on missions in this orbit. So energy demand is about 2500 kWh/day. Higher altitude orbits currently contain about 200 satellites (140 communications satellites and 60 other purpose satellites) generating an energy demand of about 6500 kWh/day.

Interplanetary

Three satellites are on interplanetary missions. One is Magellan, another is Galileo. Each satellite uses about 600 W so in a 24 hour day the total energy demand is roughly 30 kWh/day.

Interstellar

At this time, 3 spacecraft are on interstellar missions: Voyager 1, Voyager 2, and Pioneer 10. These spacecraft use only about 300 W with a cumulative energy demands of about 22 kWh/day.

Providing Space Power

There are many sources of electrical power available that have flown in space. Photovoltaic arrays, batteries, fuel cells, radioisotope thermoelectric generators (RTG) and nuclear reactors represent the systems used in space. Each of these technologies have been used on many space missions. A photovoltaic array intercepts light from the Sun and converts it to electricity. This array typically consists of many individual solar cells that are wired together to produce the total power needed for the satellite or spacecraft. In Earth Orbit, a battery system is often needed for storage of energy during the period when the vehicle is in shadow. The solar array will charge the battery while in sunlight and the battery will be used during the shadowed part of the orbit. On each successive orbit, the battery is recharged. Batteries are typically not used exclusively on satellites unless their lifetime is very, very short: several hours or days. The total mass of batteries is very, very high for missions that last longer than this short period. Fuel cells are also an option for energy storage. These cells would use solar array power to electrolyze water (H_2O) into O_2 and H_2 . The O_2 and H_2 would then be recombined and release energy during the shadow period of the orbit. Water is produced again as the O_2 and H_2 recombine. On the next orbit, the cycle of electrolysis and recombination would repeat.

For missions that require flight far from the Sun or are in shadow for long periods, nuclear power may be preferred. Examples of these missions would be flights beyond Mars or powering a lunar base during the long 354 hour lunar night. Both radioisotope thermoelectric generators (RTG) and nuclear reactors have been used on Earth orbiting and planetary spacecraft. However, current international

agreements limit the use of nuclear systems to orbits above 600 km. The Pioneer missions to Jupiter and Saturn, the Viking landers on Mars and Voyager spacecraft to the gas giants in the outer solar system all used RTG's. Nuclear-electric reactors have been tested in orbit by the U.S.A. and used operationally by Russia in ocean surveillance satellites. These reactors may be an integral part of a lunar or Mars base and will be instrumental in the propulsion systems development for future missions to the outer solar system, for example in the exploration of Pluto.

One topic that is as important as the power generation technology is the technology for power conditioning. These systems take the power produced by a solar array or reactor and process it and distribute it to the different subsystems of the space vehicle. These systems are very important because their masses can be comparable to the power system itself and may be a large fraction of the mass of the satellite or spacecraft.

In summary, there are a variety of ways to satisfy space energy needs. Choosing the right system is based on amount and type of power needed, location, and especially optimization of mass.

References

- Bevington R., and Rosenfeld A. H., "Energy for Buildings and Homes", Scientific American, special issue: Energy for the Planet Earth, pp 77 • 86, September 1990.
- Bleviss D. L., and Walzer P., "Energy for Motor Vehicles", Scientific American, special issue: Energy for the Planet Earth, pp 103 • 109, September 1990.
- Brandhorst, H., personal communication at International space University, summer session, 1992.
- Chandler W. U., Makarov A. A., and Dadi Z., "Energy for Motor Vehicles" Scientific American, special issue: Energy for the Planet Earth, pp 121 • 127, September 1990.
- Chetty, P. R. K., Satellite Technology and Its Applications, McGraw Hill, Inc., 1991.
- Choucri N., "Population and the Global Environment", pp 91 • 101, Energy and the Environment in the 21st Century, Eds.: Tester J. W., Wood D. O., and Ferrari N. A., 1991.
- Deschamps M. L., "Space Power Systems for the Global Environment Age", pp 17. Proceedings of the 3rd International Symposium on Space Power Systems and Environment in the 21 st Century, Rio de Janeiro, 1992.
- Dessus B. and Pharabod F., "Energy Development and Environment: What about solar energy in a long term perspective?" pp 99 • 108. Proceedings of the 2nd International Symposium SPS 91 Power from Space, Paris, 1991.
- Edmonds, J., and Reilly, J. M., "Global Energy: Assessing the Future." Oxford University Press, Oxford, 1985.
- Gaudin, T., SPS and the next century. Proceedings of the 2nd International Symposium SPS 91 Power from Space, Paris, 1991.
- Goldemberg, J. , Energy and Environmental Policies in Developed and Developing Countries. pp 79 • 89, Energy and the Environment in the 21st Century. Eds.: Tester J. W., Wood D. O., and Ferrari N. A., 1991.
- Hoffert, M. I. , Potter S. D., Kadiramangalam M. N., and Tubiello F., Solar Power Satellites: Energy Source for the Greenhouse Century? pp 82 • 90, Proceedings of the 2nd International Symposium SPS 91 Power from Space, Paris, 1991.
- Levai, A., and Jaszay T., "Present and Future Electric Power Systems in Eastern Europe: The Possibilities of a Broader Cooperation" pp 595 • 600, Energy and the Environment in the 21st Century. Eds.: Tester J. W., Wood D. O., and Ferrari N. A., 1991.
- Lomer, W. M., *Nuclear Energy in the 21st Century*, pp 7, Atom 396, October 1989.
- Martin, A. R., "Satellite Power Systems • Promise and Perspective", pp 65 • 70, Proceedings of the International Symposium SPS 91 Power from Space, Paris, 1991.
- Mayur, R., "Energy Crisis and SPS for the Third World Future", pp 48 • 53, Proceedings of the 2nd International Symposium SPS 91 Power from Space, Paris, 1991.
- New York Times, Sunday 8 March 1992
- Reddy, A. K. N., and Goldemberg J., "Energy for the Developing World" pp110 • 120. Scientific American, special issue: Energy for the Planet Earth, September 1990.
- Ross, M. H. and Steinmeyer D., "Energy for Industry", pp 88 • 102. Scientific American, special issue: Energy for the Planet Earth, September 1990.
- Scientific American, Inc., *Energy and Power*, W.H. Freeman and Company, 1971.
- UN Population Study No 98. World Population Prospects, Estimates and Projections as assessed in 1984, UN 1986.
- UN Population Bulletin of the United Nations No 14, 1982.

3 Markets

This section on markets comprises two main subsections, 3.1 on market identification and 3.2 on marketing. In the first section the market for solar power is segmented primarily into near term (2000-2020), mid term (2020-2040) and long term (2040-2100), with a second subdivision of space based and Earth based markets. Further segmentation of these markets is given, and for each of the segments the basic questions will be answered: who are the users, where are they located, what quantity of power they require, what price level would be competitive and what is the present size of this segment. The predicted growth of the market segments is also discussed, and the overall trends can be traced by reading the three subsections of near, mid and long term. The section on marketing will describe what the actual product of the International Solar Power Organization (ISPO) can be, who are the players in the market, what are potential spin-offs, what is the proposed pricing strategy seen in light of forces of supply and demand, and finally, promotion and publicity. Here, the image of ISPO and its role as player in the global market will be addressed.

3.1 Market Analysis

The first step in examining any potential program is to determine the market for the proposed product. For business ventures this market is expressed in terms of potential revenues, while for government projects it is assessed in terms of tax dollars and going to the public. A thorough market analysis can reveal any project show-stoppers or can provide a strong force to drive it forward toward completion.

For the Space Solar Power Program the product is power, but it is power of a special type. Markets for power exist everywhere that people live or work, but markets for *beamed* power may be different from markets for power generated on site. The following sections will examine those markets as they are likely to take shape, in the near term and far, both on Earth and in space.

3.1.1 Near-Term Applications

Near-term applications of space beamed power can most conveniently be categorized in terms of the end user: we consider below first space based and then earth based end users.

Space

In the near term, we consider only market scenarios where a customer satellite can make use of beamed power without any modification to the satellite hardware; thus it is possible to provide power to satellites already in orbit under this scheme. This serves as a definition for "near term". The only power transmission technology that can achieve this is near optical or higher frequency EM (light), which can be converted into electric energy by the satellites solar arrays (the maximum wavelength for a Silicon array to generate power is around 1 micrometer).

In general, a laser is the only practical means of generating high intensity, high power collimated light. Thus only laser based power beaming is considered below. The laser may in theory be located on the ground or in earth orbit. It is important, however, to consider the state of the art in laser technology, for the near term time scale leaves little potential for extensive research and development.

Significant technological advance is necessary before high power lasers may be launched into space for reliable autonomous operation. State of the art lasers of required output (tens of kilowatt level) in the necessary frequency bands are extremely massive (of order many tons), inefficient and largely unproven machines that require skilled maintenance after every firing test. However, promising technologies are under development, particularly for example, the semiconductor diode phased array. Many developments may have been made during the US Strategic Defense Initiative, but are not yet in the public domain. A technical account of laser technologies may be found in section 7.2.2, but it is clear that a space based laser beaming power station is not viable in the near term. The emphasis of this section is therefore on ground based laser power beaming, which still poses some challenges in adaptive optics, power output and heat rejection.

It should be noted at this point that by tuning the laser frequency to the quantum band gap of the solar array, significantly increased array efficiencies are achieved over normal solar radiation (approximately 50% as opposed to 10-15% [Brauch et al 91]).

Since poor weather will interrupt ground based lasing, a continuous supply of power to the client could not be ensured. Ground laser stations could be based in areas with excellent weather conditions, such as the Sahara Desert or south western Arizona, or more than one ground station in different locations could further reduce the risk of the power supply being "weathered out". However, uninterrupted power beaming cannot be guaranteed, and this is an important feature of ground based laser power beaming.

Power Beaming for Geostationary Based End Users

The majority of geostationary satellites are for communications. These satellites have design lifetimes of typically 10 to 15 years. Meteorological satellites and some other proposed earth observation platforms are also geostationary orbit users. It has been proposed that geostationary satellites' lifetimes could be extended by power beaming to degraded satellite power systems. This can be analyzed as follows:

Geostationary satellites become unusable for one of the following reasons:

1. Malfunction of payload or satellite bus
2. Exhaustion of on board propellant for station keeping and attitude control
3. Degradation of batteries to the degree that operation in eclipse is no longer possible or degradation of solar arrays to a degree that they are unable to power the payload and charge the batteries after eclipse.

Cases 1 and 2 are clearly not power system issues. Case 3 might be alleviated by providing the spacecraft with beamed laser power which could prevent deep battery discharge during eclipse, since battery deep cycling is the main contribution to their degradation, or by boosting degraded solar array output in general. Received power levels should be of order 1 kW to be useful. This application scenario is one that is popular with researchers working on space beamed power, and is often vaunted as one of the viable space power missions.

Geostationary Market Size and Value

However, there is no significant market for power beaming to existing communications satellites for life extension purposes, and the optimism of some in the field is misplaced. Satellite design attempts to balance the life limiting factors so that they reach life expiration simultaneously. Solar arrays are sized to give operational power at end of life, and battery systems are massive enough that they, likewise, provide sufficient performance throughout the satellite lifetime. The end of the satellite's useful life is almost always brought about by propellant exhaustion. To our knowledge, there are no documented cases of battery or solar array degradation alone ending the productive service of a satellite. [conversation with Brandhorst, Lewis Research Center] In some cases, hardware failure of one power subsystem has increased the demands on the remaining subsystems (such as failure of one battery pack), and in these cases, beamed power could be of use. The incidence of such failures, however, numbers one or two cases out of 200 or so geostationary satellites launched.

The market value of such a small number of potential clients can be established: information from the US organization Comsat indicates that revenue from regenerating a spent satellite would total US\$10M per year, and the organization would be willing to spend 20 % of this total to keep the satellite in operation. [Muelenberg, Comsat, via Brandhorst] The market value is therefore \$2M per year for each satellite. Alternatively, if a hardware failure occurs early in the satellite's life that can be aided by beamed power, the value of this can be judged by considering the savings derived from a delay in procuring a replacement satellite. If this cost (including launch) is \$400M, and assuming a 10% discount rate, a year's life extension is worth a nominal \$40M. However, one must factor the increased complexity and capacity that the new satellite will have: possibly as much as twice the capability (though more likely less than this). This effectively reduces the value of life extension to \$20M per year. The cost of establishing ground based laser systems in the near term is, however, of the order of billions of US dollars (see section 11.1.1).

Such revenue, which is possible on a very occasional basis (when these very uncommon hardware failures occur), does not render this application a viable market for space beamed power, despite the optimism of some in the field.

Low Equatorial and Polar and Other Orbit Markets

The market for power in LEO will be driven by systems such as space stations and other free-flying platforms for commercial and government activities. Past plans for these systems were very ambitious and many vehicles were envisioned. The power hungry environment needed to conduct all of these diverse missions could be augmented by beamed power.

However, since a ground based laser is in practice limited to beaming within 60° of zenith [Landis 92], providing coverage over all longitudes for low earth orbit satellites would require many ground stations along the orbital ground track. A 500 km altitude orbit reaches an azimuth of 60° with respect to a point on the ground when only 900 km away laterally, and around 40 ground stations would be required for continuous illumination of an equatorial orbit at this altitude. For the Space Station Freedom orbit, however, (or any inclined orbit spacecraft) the 28° orbital inclination renders totally impractical the supply of ground based laser energy on a continuous basis, since the ground track of the orbit is so varied. The region between 28° north and 28° south would have to be populated with ground stations every 1800 km around the entire circumference of the world for continuous coverage, and even during direct overflight of a ground facility, the space station would remain within 60° azimuth for less than 3 minutes.

Therefore, the servicing of inclined orbit LEO spacecraft must wait for the medium term, when space based laser power stations may become viable (see below). Shuttle tended payloads fall into this category, as do polar orbiting customers whose orbital inclination is even higher.

Small satellites may also be a potential market for beamed energy. The most significant limitation on small satellite capabilities is the power they are able to generate, which is normally of the order of 100W or less (100kg class spacecraft) due to the limited surface area on which to mount photovoltaic (PV) cells. Power beaming to small satellites in higher equatorial orbits could more than double their power supply since with body mounted PV cells they could receive solar as well as laser energy simultaneously (heat rejection problems will limit the amount of power that can be received). This would significantly increase the range of missions and applications such cheap satellites could undertake. Many small satellite applications involve high inclination orbits however, and the total market for power to small satellites is likely to remain limited to a handful of such space-craft, even if greater numbers were launched to take advantage of such a power supply system.

Summary of Market Analysis for Near Term Applications in Space

The market in the near term is essentially limited to aiding an occasional malfunctioning high value satellite in geostationary orbit, and few limited high equatorial orbit missions, such as small satellite power boosting. The net value of this market is unlikely to be large, but the commercial viability of a near term ground to space power beaming system is analyzed in section 11.1.1.

Earth Applications

Identifying the near term Earth applications of space solar power for Earth use, we consider the time frame unto 2020. It is our assumption that Space Solar Power delivery to the electricity grid will not yet be done on a large scale. As a consequence, we tried to identify market niches which could facilitate the gradual establishment of solar based power systems. A basic assumption for this analysis is that the cost of conventional energy resources will have a stable present value, and that cost for environmental impact is not yet included.

The following market cases meet this profile:

- remote locations with a developed energy demand, that have generator power now and could use solar power as an alternative
 - locations that use little power now and that are not connected to any grid, like villages in developing nations
 - power relay from resource-rich areas on Earth (in stead of in space) to an area with high power demands
 - electricity grids with high peak power demands.
-

We discuss each of these market segments discussed hereafter, first summarizing the main characteristics, and then giving the supporting analyses if needed. Data on world energy demand and future growth has been extensively used in this section (see Chapter 2).

Remote Locations

In the category of remote locations with a developed energy demand are towns or villages in Alaska or Siberia, research centers in Antarctica and small islands or groups of islands. Except for the islands, this category is located at high latitudes with harsh environmental conditions. The power demand per location ranges from 100 through 1200 kW (or more) or from 600,000 through 7.5 million kWh per year. As reasonable price level we found \$0.22/kWh for remote locations, but for Arctic regions the price is estimated at \$0.58/kWh due to higher transportation costs to these regions. Both delivering continuous and dis-continuous power seems sensible, since both take equal fuel resources at the remote location. We think of melting ice for drinking water, heating water in a boiler for later use, etc. This market segment will be relatively stable, since a certain amount of people will always live in these places, while a strong growth is unlikely by the character of the location. A specific argument for abandoning conventional fuel at the high latitude locations is that biodegradation is very slow due to the low temperatures, and hence pollution of the environment with spilled fuel can cause longer lasting damage than in lower latitude areas.

It is assumed that 100 kW is the minimum power demand for these cases, since this corresponds to a practical generator size. In the US settlement in Antarctica there are presently about 200 researchers, with four 600 kW generators installed of which two are nominally used. The electric power demand in this case equals 1200 kW, with heating likely not being included (fuel can be directly used for this). For villages and islands the demand depends on the population size and could be higher, but since we have no data available on this we take 1200 kW as practical upper limit for this analysis. To evaluate the yearly energy demand, we assume a 70% time loading of a generator and get 613,200 kWh/year for each 100 kW generator (100 kW x 70% x 8760 hours/year). So the energy demand for a remote location ranges from 600,000 through 7.5 million kWh per year. No reference has been found about the number of these locations.

Since diesel fueled generators are mostly used at present to generate electricity at these places, we use the corresponding cost to assess the competitive price range for delivering electrical power to their local system. Costs of electricity from diesel electric generators depend on the size of the generator, and are given below [Leonard, 1991]:

- \$0.57/kWh for 10 kW generator size
- \$0.22/kWh for 50 - 100 k generator size
- \$0.10/kWh for 250 kW generator size.

ranging from a high level of \$0.57/kWh through \$0.10/kWh. The bottom end is equal to the average end user cost of grid electricity, and we therefore assume this to be as low as it can get. We would like to know the costs both at a remote and an Arctic location, and the cost of transportation for fuel and maintenance is obviously much higher for the latter. Since it is not clear what level of transportation costs are included in the above quoted figures, we have made a second assessment. In Biosphere2, the closed ecological experiment facility near Tucson, Arizona in the US, 4500 kW of diesel/gas fueled generators are installed. When running on diesel, fuel costs are \$0.07/kWh. Another \$0.02/kWh should be added if we assess capital cost, depreciation and maintenance based on further Biosphere 2 data [private communication with B. Zabel, 1992], giving a total of \$0.09/kWh. This corresponds well to the above quoted low end value (250 kW size). Since we consider Biosphere 2 to be close to an urban area, the remote and Arctic locations should have a higher price. Fuel cost in Antarctica are said to be about a factor of 8 more expensive than in the US, which would give a cost level of \$0.58/kWh which is near the high end of the above listed range ($\$0.07/\text{kWh}$ fuel costs x 8 + $\$0.02/\text{kWh}$ operations = $\$0.58/\text{kWh}$). Considering this, we assume a price of \$0.58/kWh for Arctic and other high latitude regions; if environmental cost would be factored in we assume that the price could be as high as a few dollars per kWh. A medium level of \$0.22/kWh is a reasonable value for locations far from urban areas which have a rather high transportation costs (but not of the level of Arctic locations).

Developing Remote Locations

Remote locations with a developing energy demand are found primarily in developing countries at low latitudes. The present energy use as well as availability is small. Providing small amounts of

energy to these locations seems to give direct and substantial benefits to the population: basics like drinking water, cooking, irrigation and telecommunication. As well, the environmental benefits are important, since using wood as main fuel resource leads to deforestation. Availability of power for this user segment seems the priority rather than high reliability or continuous delivery, and no competing systems are yet largely installed. This market segment is therefore suited for relatively new technologies of which the long term reliability still needs to be demonstrated. As far as price is concerned, developing locations are similar to developed remote locations and we think the value of \$0.22/kWh can be used. The power demand per location can range from 10 kW to 10,000 kW, or an energy demand ranging from 60,000 through 60 million kWh per year. The total market size is estimated at 350 billion kWh or an equivalent \$77 billion per year. Much of the world energy demand growth is predicted in developing regions, and since we do not expect immediate large installation of grids, the segment of remote developing locations should grow in the near term. Quantitatively, this segment could grow to 1000 billion kWh per year.

For estimation of the power demand we again use the comparison with the generator alternative. Delivering power at 10 kW seems a reasonable low end, since no electrical energy could be available now, while providing more than 10,000 kW (or 10 MW) seems no longer to justify the relatively high price of \$0.22/kWh. In energy this evaluates from 60,000 through 60 million kWh per year for one location. The total market size is estimated as follows. Electrical energy use for all developing countries is currently estimated at $3.5 \cdot 10^{12}$ kWh yearly [Chapter 2], and let assume that 10% of that could be used in remote locations, giving a demand of 350 billion kWh for this market segment. With the previously mentioned demands per location, this would mean in the order of 10,000 to 1,000,000 locations. In the time frame unto 2020, the energy demand in the developing world is currently predicted to grow by a factor of 3, hence this market segment is also expected to grow by a factor of 3 in this period, growing to 1000 billion kWh per year. At a price of \$0.22/kWh, the yearly monetary market size grows from \$77 billion to about \$230 billion.

Although the present market size should be as large as \$77 billion a year, a problem is the lack of hard currencies in these locations and it is questionable whether this amount of money is available there. But the benefits are large: a large number of people would have direct improvements of their standard of living, and we expect substantial benefit to the sensitive tropical environment, which is of global concern. Even though the end-users probably can not pay directly for the power, it seems worthwhile to develop this segment and look for alternative financing mechanisms, for instance reallocating aid funding to generate electricity and donate electrical energy instead.

Since these areas are found at low latitudes, Earth based solar power could be a good first step, provided that the climate is not too cloudy. The area that is allocated to become the rectenna site could first be covered by low-cost solar cells, and deliver discontinuous power e.g. for heating water boilers. In a next step, the area could be transformed to rectenna for space based power. This could be helpful to phase the implementation of solar power.

Power Relay

Relaying power from one location on Earth to another is another segment. As long as there exist locations with large natural energy resources but with a low demand, the energy could be generated and transported to high demand areas. This is especially useful for clean renewable resources like wind and water. For cases where this approach is presently not viable because of transportation losses of the electricity, relay of power via a microwave beam reflected by a satellite in orbit may be considered. As an example: supplying power generated in the Amazon region in Brazil to cities like Boston or New York in the USA 4000 miles away. [Brown, 1992] The users of relayed power would be the electricity companies operating the power grid, typically requiring a high reliability. For the near term, these markets are roughly located between 40 and 55 degree latitudes, basically North America, Europe and Japan, but start to spread in the developing world as well. The market size is in the order of 2400 billion kWh, showing near term growth to a maximum of 3600 billion kWh especially in the developing world. A price level for energy transfer over 3000 miles is in the order of \$0.01/kWh; this does not account for costs of the energy itself nor of the installed capital for the transmission system.

Estimating the market size of this segment, we refer to the total yearly generated electricity in these places, roughly equivalent to 16,000 billion kWh (30% of $54 \cdot 10^{12}$ kWh, refer to Chapter 2),

or an equivalent power level of 1850 GW ($30\% \times 54 \cdot 10^{12}$ kWh / 8760 hours/year = 1850 GW). Assuming that upto 15% could be generated better and/or cheaper at a distant location, the market size for relay power is estimated at 2400 billion kWh or 275 GW yearly. Growth in market size: since the developed world's energy will be stable, growth is in the developing world. In the period to 2020 about 13,000 billion kWh grid demand will be added (30% of $50 \cdot 10^{12}$ kWh), almost doubling the grid market size. Since the spread of grids will give fewer suitable 'distant' locations, relay market will not show such a large growth, we assume the maximum size to range between 2600 and 3600 billion kWh.

Calculation of the power loss for a 400 kV high voltage transmission line [SME Mining Engineering Handbook, 1973] transferring 1 GWatt over 3000 miles gives a total energy loss of 1.62 billion kWh a year, or \$81 million yearly, on a total value of \$440 million transferred power, that is a loss of 18%. This evaluates to \$0.01/kWh powerloss for our example. In order to assess total cost of transfer over this distance, the capital cost, depreciation and maintenance of the high voltage power lines themselves should be added. Since we have no data available on the costs of such a system, we will roughly assume the power loss value of \$0.01/kWh.

Peak Power

Similar in characteristics to the above segment is that of supplying additional power during peak loading times. Users will be the electricity companies operating the grid in currently developed locations, which will require high reliability that the energy source is available when the need it. The amount of power required is 500 MWatt or more per location, with at present a global yearly demand as high as 3200 billion kWh. The market will grow to 6000 billion kWh especially in the developing countries. With a price of \$0.10/kWh the monetary value is around \$320 billion per year at present.

In order evaluate the size and price of this segment we make the following assumptions:

- predictions for world population and global energy demand are as per Chapter 2
- 30% of the total energy currently produced is generated as electricity ; this percentage is expected to remain constant
- as average present end-user price for electricity we use \$0.10/kWh in '92 economic conditions; lower in the USA and higher in most European countries
- delivering one kWh baseload power to the electricity grid will yield 50% of the end user price, i.e. \$0.05
- the price of peak power is double that of baseload power, i.e. \$0.10/kWh. We assume here that peakload is from 07:00 to 10:00 (a.m.) and 17:00 - 21:00 (p.m.)
- approximately 50% of the total installed power capacity is baseload, the other 50% being peakload power.

The total yearly generated electricity in developed locations is roughly equivalent to 16,000 billion kWh (30% of $54 \cdot 10^{12}$ kWh, refer to Chapter 2). If 50% of the capacity is operating for 6 of the 24 hours per day, it is providing 20% of the total electricity. Hence 3200 billion kWh electricity should roughly be the peak power demand, equivalent to a global market of \$320 billion per year. About growth: grids installed in developing countries will let the global electricity demand grow to about 30,000 billion kWh, almost doubling it; the peak power market will consequently also roughly double over this time period. Taking the larger electricity grids where power is generated at the GW level, the quantity demanded at a single location can be 500 MW or more.

3.1.2 Mid-Term Applications

Defining the markets for space solar power for the mid term is an interesting problem, as the time period in question is one of transition and can only be vaguely defined. It is believed that there may be a time frame where sufficient experience has been gained with power beaming technology to emplace commercially active power satellites in the 100 kW to 1 MW range—big enough to provide useful power in space, but not yet on the scale necessary for commercial power beaming to Earth. Because the power levels involved are likely to still be small on a terrestrial scale during this period, the market for beamed power on Earth is unlikely to be significantly different from that described in section 3.1.1 above. Thus most of this section is

devoted to space-based applications, with only the differences from the near-term market presented for Earth applications.

Space Applications

As transmission technologies improve and experience with beamed power grows, new markets will be opened up for commercial beamed power. From a business perspective, the main road block to commercial usage of beamed power in space is the conservative nature of the space industry. Lead times between development of a technology and the first real use of it can be extremely long, as few designers are willing to risk their spacecraft with unproven technologies. An excellent example of this comes from the electric propulsion field. The first space testing of ion engines, SERT 1 (Space Electric Rocket Test), was conducted in 1962 from a sounding rocket. Only now, 30 years after the first space tests were conducted are spacecraft being launched which use this technology, despite the large savings in propellant it can offer.

Mid-term markets in space will appear when transmission technologies have been shown to be reliable enough so that spacecraft designers are willing to base their power system designs on receiving power rather than generating it themselves. Reaching this state of technology development will be quite a big step. To convince businesses and governments to risk their satellites on an outside power source, a fully tested, fully redundant system will have to be in place. This implies a constellation of satellites such that at least two power generating satellites would be in view of a client satellite at all times. The time frame for entering into this mid-term phase is highly dependent on the degree to which the near-term market is exploited. Optimistically, if the first application of power beaming for satellite lifetime extension occurs within the next decade and power transmission technologies are actively pursued, this mid-term market could conceivably begin to appear by about 2010. This is further complicated by the currently immature state of space laser technology. A more cautious estimate would predict this sort of market appearing by 2020 or 2030.

So taking the "mid term" to be start 30 years from now, we need to try to predict the markets and technologies which will exist. There are several possible markets for beamed power in space: one could sell satellite lifetime extension; eclipse power for satellites or space stations, allowing a reduction in battery weight; baseload power for the same; or power for OTV's moving between LEO, GEO, and LLO using electric propulsion. Each of these potential markets has distinct advantages and disadvantages; trying to predict their relative weights for a market decades in the future is a difficult task.

Satellites

Extension of satellite lifetime was examined above as a possible near-term market, but did not appear to be a source of sufficient revenue to support a power satellite. For the mid-term, however, it may be a viable market, and could take on several different forms. Even though some satellites may be designed to be dependent on beamed power in this period, it is likely that most will continue to rely on their own power systems. With this in mind, and predicting a moderate increase in satellite cost in the next decade, one can make some guesses about the potential value of this market. Taking a satellite costing about \$300 million with a 20 year life span which might be launched 10 years from now, each year of life extension would be worth about \$15 million. If such a satellite's life could be extended for about 4 years, this would give a total value of about \$60 million for extension of one satellite's life. Noting that maximum eclipse time in GEO is 1.2 hours/day, at most 20 satellites could be serviced using a single transmitter for a total value of \$1.2 billion.

Figure 3.1 below shows the results of a simulation run for Intelsat VI over the period around the vernal equinox. As can be seen from the graph, the dark time for the satellite drops off sharply at either end of the eclipse season. Average dark time is about 3.7% over the eclipse season, so that in the case of a constellation of satellites, duty cycles will allow each satellite to service about 27 satellites over the relevant period. Using this figure instead of the individual peak duty cycle yields a potential market worth of about \$1.6 billion.

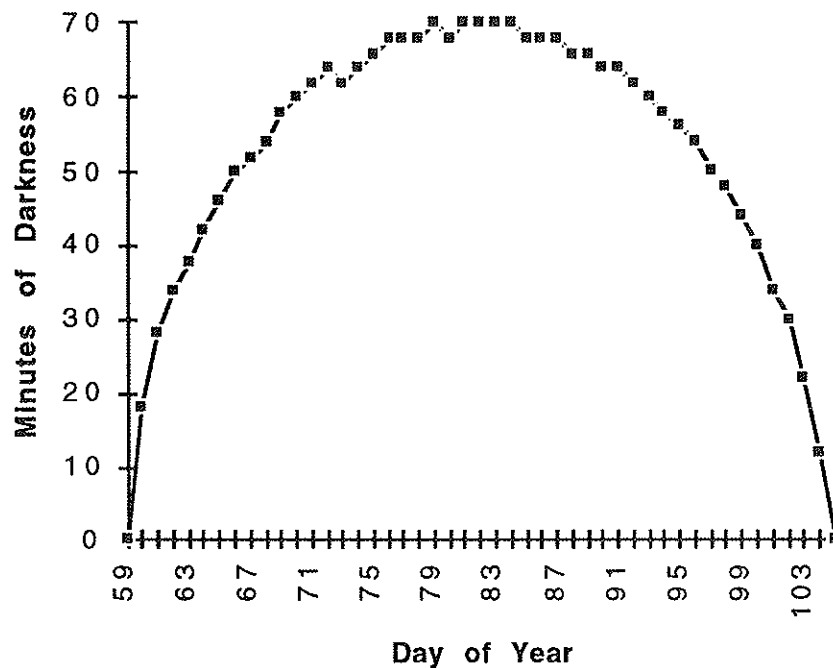

Figure 3.1 Eclipse Lengths in Geostationary Orbit During Eclipse Season

Of course, several things must be considered when examining the simple calculation above. First of all, the power satellite itself will be in eclipse for some portion of this time and will be unable to transmit, though for a constellation this factor may be ignored as presumably one power satellite would always be in view. Secondly, it should be noted that geostationary communications satellites tend to orbit in clusters over strategic areas of the globe. As satellites in groups of this sort would sometimes be in eclipse at the same time, the 27 satellites serviced would have to be relatively spread out. Also it should be noted that the 1.2 hour maximum eclipse occurs only twice each year. For the majority of the time eclipse servicing would not take up a power satellite's full duty cycle.

The question of capacity is quite important in assessing the real worth of this market. The above calculations assumed a constellation of satellites each servicing on average 27 other satellites. Taking a minimum constellation size of three power satellites, it would take *at least* 81 satellites expiring due to battery failure to fill the market for those three power satellites. As the number of communications satellites failing for this reason in the last decade could be counted on the fingers of one hand, it seems that this market would be extremely unlikely to fill, even when one considers the rapidly growing communications network enveloping the world. At best this market could provide a profitable sideline for satellites already in place and serving another market of larger volume.

Another important question to answer concerning this calculation is whether or not the communications company will need the extra satellite lifetime. Table 3.1 shows something of the recent trends in communications satellite mass, power, capacity, and lifetime. Clearly we can expect that communications satellites may reach lifetimes of 20 years by the year 2000. When extending the lifetime of a satellite which has been working for 20 years, one must wonder how outmoded that satellite has become. Will it have the capacity and bandwidth to compete in the market of 25-30 years after it was developed?

**Table 3.1 Recent Intelsat Communications Satellites
[Madry, 1992]**

	Intelsat V (1980)	Intelsat VI (1989)	Intelsat VII (1992)
Weight (kg)	1,012	2,251	1890
Electric Power (W)	1288	2100	3500
Capacity (Channels)	15,000	35,000	21,000
Design Life (Years)	7	10	15

The same operational time-period of eclipse servicing might be of interest for satellites other than those at the end of their lives. By designing satellites to take advantage of beamed power rather than relying on batteries during an eclipse, significant mass savings might be achieved. Figure 3.2 shows the relationships between power needed during eclipse and battery masses for current levels of technology. Keeping in mind that nickel-hydrogen batteries are likely to replace nickel cadmium within the near future and that in the next three decades power levels are likely to increase substantially, one might optimistically guess that a mass savings of about 150 kg per satellite could be achieved. If one makes the rather conservative assumption that transponder mass remains the same over the mid term to balance the above optimistic assumption, and assumes the current transponder earning potential of \$5 million/year remains constant, one can calculate the potential market value. Taking 150 kg at 20 kg/transponder, the additional earning potential comes to \$37.5 million/satellite. Multiplying as before by 20 satellites, the market comes out to be about \$750 million/satellite, or \$1 billion for the constellation case where each power satellite services on average 27 clients.

The same 150 kg of mass savings could be used to add propellant to the satellite and extend its possible lifetime in orbit. The problem with this, however, is that unlike the lifetime extension market described above, these satellites would require servicing throughout their lifetimes, instead of just at the end. A communications company would by no means be assured that the satellite would live long enough in orbit to benefit from this extra propellant, so any revenues would either be small relative to the former lifetime extension case or would come 20 years after the servicing began, if at all. Also, the total worth of the extension would have to be divided by the whole satellite lifetime instead of just the added years.

As with the life-extension market described above, several factors must be considered when examining the numbers above. The first thing to be noted is that servicing this market segment takes up only a small portion of the satellite's total yearly capacity. Power not needed for eclipse operations of GEO satellites could conceivably be used for reducing or eliminating dependence on batteries for satellites in lower orbits. Mass savings in batteries are more difficult to assess in terms of monetary value for such satellites, however, so any numbers generated here would probably be next to meaningless. Qualitatively, however, one can note that lower orbiting satellites are much more dependent on batteries so that potential weight savings are greater, but also that lower satellites are harder to track and have longer eclipse duty cycles so that the number of clients which could be serviced by a single power satellite would be significantly reduced.

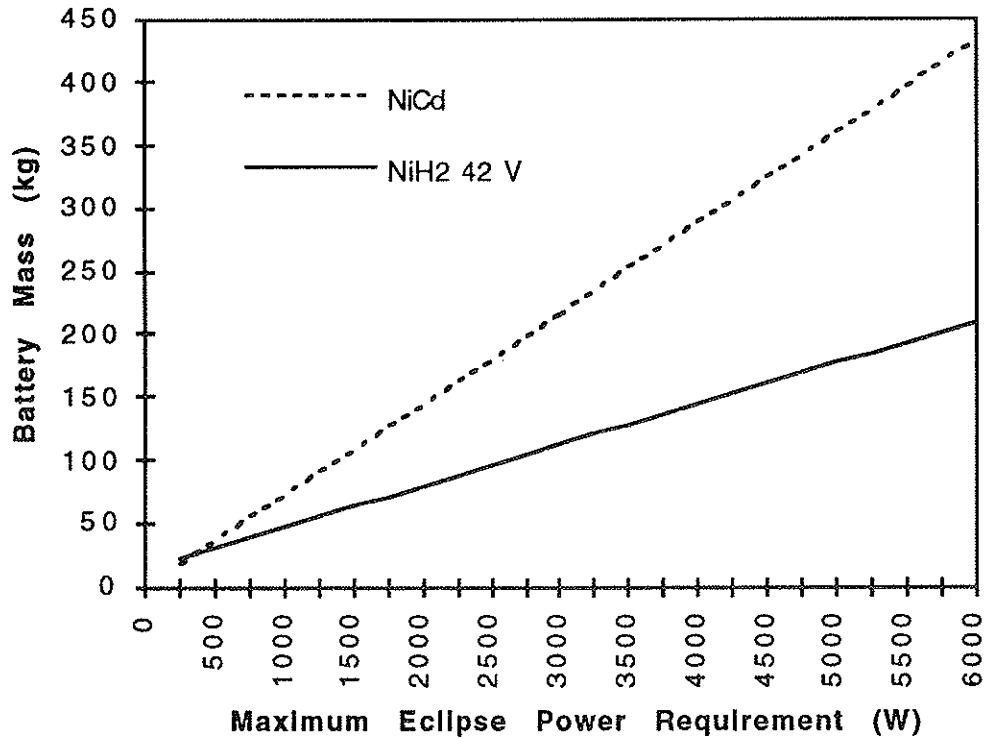

Figure 3.2 Battery Masses for Communications Satellites
[Pidgeon, 1991]

As an example of a potential LEO client, let's look at Space Station Freedom. Though Freedom is not currently in flight, one might expect that it would be in orbit in the time frame considered here, and good data is available concerning its orbit and battery power system. To supply the station's 56 kW of power during an eclipse the station uses 24 ORU's, each containing 36 nickel-hydrogen cells for a total mass of almost 4 metric tons. Taking the launch cost per kilogram as \$12,000, the savings gained by a battery-independent design would be \$48 million. As these batteries would have to be replaced every 10 years or so years, one can calculate a market worth of about \$5 million/year.

As \$5 million/year does not seem to be an adequate market to support a single power satellite, much less a constellation, one might look at the possibility of providing a space platform with a power increase. Here the savings would not come from replacing the weight of the solar panels, but from the fuel savings which would result from the reduced drag of the platform by eliminating the need to add new panels. By using beamed power, the platform gains the benefit of being able to place its most bulky components where the drag penalty due to their size is minimal while keeping the accessibility of the LEO location. Using Space Station Freedom as a baseline design for calculating this market, it has been estimated that the possible revenues from fuel savings would be on the order of \$150-300 million/year if an Ariane type launcher was used for fuel resupply. [Eurosace, 1992] One must remember, however, that such a power increase would require a dedicated power satellite.

Another possible market which has been suggested for the mid term is providing baseline power to satellites. The reduced mass required for laser-receiving photovoltaics or rectennas for microwave power reception is pointed to as a potential revenue source. The main problem with this concept, however, is that each power satellite, or rather each transmitter on a power satellite, would be fully occupied with providing power to the client satellite, instead of servicing 20 or more satellites as in the eclipse servicing case. With current transmission technology, it seems unlikely that the revenues from support of only a single satellite would be adequate to pay for a separate power satellite. This may change with technology, however; it may be that within 30 years transmitters will improve enough so that a single satellite could beam power to one or two

dozen satellites simultaneously. At the present, however, this market route seems unlikely to lead to commercial viability.

One other is to illuminate solar arrays which have degraded due to the adverse effects of radiation. It is thought that perhaps this treatment could extend the life of a satellite or allow weight savings in solar panels. Solar panels are now sized to take degradation into account and are hence larger than necessary at the beginning of life so as to generate adequate power levels at the end of life. If this extra panel area was not needed, perhaps the weight savings would be enough to provide a market for beamed power.

Table 3.2 presents the statistics for a hypothetical satellite in GEO making use of this service. The satellite is assumed to consume 10 kW of power, a number much higher than the consumption of current communications satellites, but may be reasonable for satellites launched 20 to 30 years from now. Mass savings are calculated as the mass necessary to generate the 10 kW at the beginning of life subtracted from the mass of solar panels necessary to generate the same power at the end of the number of years shown in the left column. The mass and degradation models used were for solar arrays of the type used on the European satellite Olympus. [Pidgeon, 1991] The duty cycle, or percentage of time which the laser must be focused on the client's solar panels, was calculated assuming laser intensity of 5 Suns producing 8 times the array's normal power level. It was also assumed that the client satellite had batteries for power storage, so that the necessary energy could be imparted in a short burst instead of a continuous beam.

The maximum mass savings possible with current technologies seems to be about 35 kg for a satellite with life expectancy of 20 years. Using the figures presented above of \$5 million/year of revenue for each transponder and 20 kg/transponder, it seems that the weight savings for each satellite would amount to a value of \$8.75 million. Since a single client requires on average about 2.5% of a power satellite's time, at most 40 clients may be served by a single power satellite giving a total saturated market worth of \$350 million/year.

Unfortunately, as with the other potential markets described above, there are problems which reduce the attractiveness of the market. First of all, the case described above assumed no significant advances in solar cell technology. No solar cell weight reductions or increases in efficiency were considered, nor was the possible introduction of radiation-resistant indium phosphide cells. It is conceivable that for structural and vibrational reasons large flimsy arrays of lightweight solar cells will not come into widespread use over the next two decades, but some advance in the state of the art should be expected. However, given present trends in the photovoltaic industry it seems likely that indium phosphide solar cell costs will drop substantially and that they will come into widespread use on geostationary satellites. Such a development would preclude exploitation of this market niche.

Table 3.2 Duty Cycle and Mass Savings for Servicing of Degraded Solar Panels

Years in Orbit	Degradation Factor	Duty Cycle	Mass Savings (kg)
1	0.96	0.006	5.55
2	0.92	0.013	12.23
3	0.90	0.017	16.21
4	0.88	0.020	19.06
5	0.87	0.023	21.29
6	0.86	0.025	23.13
7	0.85	0.026	24.69
8	0.84	0.028	26.05
9	0.83	0.029	27.25
10	0.83	0.031	28.33
11	0.82	0.032	29.31
12	0.82	0.033	30.21
13	0.81	0.034	31.04
14	0.81	0.035	31.81
15	0.81	0.036	32.53
17	0.80	0.037	33.83
18	0.80	0.038	34.43
19	0.79	0.039	35.00
20	0.79	0.039	35.53

Electric Propulsion Systems

In the near-future, the demand for satellites in Earth orbit will continue to increase. The programs of Earth resources and environmental monitoring will require many new systems in LEO, intermediate high orbits, polar orbits and GEO will need power systems. Many instruments will be on these vehicles and they will require higher power levels than that of current spacecraft: tens to hundreds of kilowatts (kW) versus only several kW typically used by current systems. The advent of these higher power levels will allow the consideration of more-advanced on-board propulsion and power technologies for satellites. These would include electric propulsion and also other power systems to augment the solar arrays of planned vehicles.

Future satellite systems will likely demand higher payloads for more extensive and more economical commercial activities. One of the most powerful ways to improve the cost effectiveness of satellites is to use high performance propulsion systems. Current propulsion systems have a relatively-low specific impulse and even small improvements can allow substantial increases in the usable payload.

The potential of electric propulsion also depends greatly on the mission length, mission type and total spacecraft mass. The markets for beamed power electric propulsion systems for applications in OTV's, Lunar operations, and interplanetary travel will be considered below.

Over the past several decades, NASA and other space agencies have conducted market analyses of the traffic from LEO to GEO and other orbits. The traffic models were assuming many different missions, including a manned presence in GEO. If these models were accurate, there would be a very high demand for an OTV. The current budget projections, however, do not appear optimistic for the OTV market.

One potential scenario using electric propulsion for LEO-GEO transfer may be used as an example of an optimistic market for beamed energy transportation. [Palaszewski, 1987] In this analysis, there were 256 missions over a 16 year period. To deliver these payloads from LEO to GEO, a number of OTV's are needed. This "fleet" of electric OTV's used either a 100 kW solar array or 1 MW nuclear reactor. The largest number of xenon ion propulsion vehicles that were needed is 11 for a 1-MW power level and 21 for a 100 kW power level. The round trip times for the 100 kW OTV's (LEO-GEO-LEO trip) is 400 days for the 100 kW OTV's and 200 days for

the 1 MW OTV's; this is the longest trip time for the OTV's. The payload for these missions is 11,400 kg.

Lunar transportation may also represent a potential mid-term market for beamed power. With the potential of the Space Exploration Initiative, there will be a transportation system established between the Earth and the Moon. Initially, the missions to the Moon will be infrequent, with several robotic probes being sent to survey the mineral and topographical distributions on the lunar surface. This will help identify the best site for the lunar base.

Beamed power may be able to supply power for orbital transfer vehicles from LEO to Low Lunar orbit (LLO). A lunar base construction program would have to deliver up to several hundred metric tons in LLO. This mass would include the lander masses for the descent to and ascent from the lunar surface. There will be potentially up to several missions per year to LLO using electric propulsion vehicles. These vehicles could use beamed energy from either laser or microwave sources.

During the construction of a lunar base, there will be an opportunity to use electric propulsion for cargo delivery. [Palaszewski, 1988] An analysis of the transportation requirements from LEO to Low Lunar Orbit (LLO) has shown that 78 flights are required to deliver mass to LLO over a 19 year period. By using electric propulsion, there may be a potential market for power beaming. The analysis considered three power levels of OTVs: 100 kW, 300 kW and 1 MW. The predicted fleet sizes for these three power levels were 7 for a 1-MW power level, 18 for a 300-kW power level and 47 for a 100-kW power level. The longest round trip time required to travel from LEO-LLO-LEO was 257 days for the 1 MW system, and 770 days for the 300 kW OTV. The 100 kW OTV was not considered viable because of the extremely long trip time. The largest payload masses carried were 35,000 kg.

It is difficult to imagine that an interplanetary spacecraft will use beamed energy for primary propulsion to get to a planet. The transmission distances are so long and there is the small problem of the Sun obscuring the Earth line of site for a beamed energy system. A more likely application is the use of beamed energy to provide power to the surface of a planet from an orbiting spacecraft. Interplanetary missions may also use high power solar arrays or nuclear reactors to conduct detailed measurements of the surface and atmospheres of planets and their moons, as well as comets and asteroids.

Typical power levels that would be available for power beaming or experiments would be 10's of kilowatts for small planetary missions to dozens of megawatts for Mars missions carrying either humans or cargo. These vehicles would have an onboard power supply to power an electric propulsion system to get the vehicle to its destination. After its primary propulsion task is completed, the power supply would have much auxiliary or idle power to employ in other tasks.

Assessment for Mid Term

Of the space-based markets described above, none seem adequate to support the necessary constellation of power satellites by themselves. However, it does seem possible that a power satellite system servicing a mix of markets has some potential in the mid term. Because the eclipse power market is unlikely to saturate, servicing it would take only a small fraction of a power satellite's time each year. It is possible that this market could be filled while providing service to a LEO platform using the same satellites. For the small portion of time the satellite would provide power to the communications satellites the platform could survive on batteries if not in view of another power satellite. Conceivably, both of these markets could be exploited while also providing power for an orbital transfer service powered by satellites not in view of the platform. Note that this sort of market mixing could probably only be accomplished using a laser transmission system, as each satellite would have to be capable of sending power to a variety of locations.

Earth Applications

Identifying the mid-term applications of space solar power for Earth use, we considered the 2020-2040 time frame and assumed that space solar power delivery to the electricity grid will not yet be done on a large scale. Energy demand in the developing world has been growing in the preceding 3 decades, and more and more large scale grids are installed there. Still, the mid-term market is highly similar to the near term one, with the same basic assumption holding, that the

cost of conventional energy resources have a stable present value, and that cost for environmental impact is not yet factored in.

Below only the changes with respect to the near-term characteristics are described. The near term market and the underlying analyses being described in paragraph 3.1.1.

Remote Locations

As stated before in 3.1.1, we expect the segment of remote locations with developed energy demand to be relatively stable, since a certain number of people will always live in these places, while a strong growth is unlikely by the character of the location. Summarizing, this category comprises towns or villages in Alaska or Siberia, research centers in Antarctica and small islands or groups of islands. The power demand per location ranges from 600,000 through 7.5 million kWh per year, with \$0.22/kWh as a unit price for general remote locations and \$0.58/kWh for Arctic regions. Both delivering continuous and dis-continuous power seems sensible. The argument to abandon conventional fuel at the high latitude locations to prevent pollution of the delicate environment remains valid also in this time frame.

Developing Remote Locations

The segment of remote locations with a developing energy demand has shown growth in the preceding time period, but in this time frame it is expected that larger energy demands justify the installation of large scale electricity grids. It is likely that further growth of this segment comes to halt, since increased demand by population growth in the remote areas and increasing development (extension of the grid) cancel out growth of the 'remote' developing market. Price per unit remains \$0.22/kWh at present value, with power demands for one location ranging from 10 through 10,000 kW or from 60,000 through 600 million kWh per year. The total market size is estimated to remain stable at 1000 billion kWh or an equivalent \$220 billion per year.

Market size can be assessed as follows. The energy demand for all developing countries in this time frame is currently estimated at some $70 \cdot 10^{12}$ kWh yearly (by 2040), with 30% of that being electricity, so $21 \cdot 10^{12}$ kWh of electrical energy. Taking again 10% of this electricity demanded in sizes of 10 kW would give 33 million small villages, with a population of about one billion people. This seems not very realistic, and taking into account that grids are spreading more widely in these regions we assume that after growth in the near term time frame the percentage drops to 5% so that the demand of this segment remains stable at about 1000 billion kWh per year. At a price of \$0.22/kWh, the yearly monetary market size is equivalent to \$220 billion. The availability of hard currency in these regions is still expected to be a problem.

Power Relay

For mid term, a decrease is foreseen for the power relay segment. Since more grids will be installed by this time frame, the demand will spread over the Earth and less suitable "remote" locations will be available. The market size is reduced to the order of 1550 billion kWh, with the price level for energy transferred over 3000 miles being in the order of \$0.01/kWh.

Estimating market size of this segment, we have to assess global energy demand by power grids. The developed world shows a small decrease to $40 \cdot 10^{12}$ kWh, while the developing world shows an increased demand of $70 \cdot 10^{12}$ kWh. With 30% of these values being electricity the global grid demand is as high as $31 \cdot 10^{12}$ kWh ($40 \cdot 10^{12} \times 30\% + 70 \cdot 10^{12} \times 30\% \times 90\%$). Since the grids have spread around the world, the number of 'relay' opportunities will have decreased since the demand is in general high everywhere, so let us assume 5% instead of the previous value of 15%. Hence, the market size for relay power is estimated to reduce to 1550 billion kWh yearly.

Peak Power

The market for power during peak loading times has great similarity with that of power relay. The users are the electricity companies operating the grid in currently developed locations, and they will require high reliability that the energy source is available when they need it. The amount of power required is 500 MWatt or more per location, with an estimated global yearly demand as high as 6000 billion kWh. With a price of \$0.10/kWh the monetary size is around \$600 billion per year.

In order to evaluate the size and price of this segment the assumptions of paragraph 3.1.1 (peak power segment) still apply. Similar to the analysis of power relay, we assess the market based on Chapter 2 data. The total yearly demanded electricity by the grids is roughly equivalent to $31 \cdot 10^{12}$ kWh. With the peak demand being again 20% of the total, the peak load market size would be 6000 billion kWh, equivalent to a global market of \$600 billion per year. The quantity demanded at a single location is still 500 MW or more.

3.1.3 Long Term Markets

The market possibilities for beamed power in the long term are almost limitless. Unfortunately, as with most limitless things, they are hard to describe with any accuracy. Because of this difficulty, the following descriptions will be exceedingly general in nature and will almost certainly miss some of the markets which may eventually exist.

Space

The shape of mankind's future in space is a question many people have been trying to answer for hundreds of years. Just how far we will advance into space and how fast are questions which cannot be answered from the present perspective. We can, however, make some guesses about some of the steps which may be taken in the next few centuries and what the energy needs will be to take those steps. Possible long-term markets for beamed power in space include orbital manufacturing facilities, space habitats, lunar and planetary bases, and the transportation networks needed to connect them.

Orbital manufacturing facilities in the future will probably be the platforms for production of high precision materials, electronic equipment, and biotechnology. To produce their commodities in large quantities, these facilities will need large quantities of power. However, these platforms will also need an environment as free from outside disturbances as possible. Dynamic systems used to generate large quantities of power are generally noisy, disruptive devices unsuitable for use in a high-precision environment. On the other hand, solar panels large enough to supply the desired power levels would be highly vibration prone and would again be disruptive to microgravity processes. Reception of power generated elsewhere might allow these orbital factories to consume large quantities of power without contaminating the purity of the microgravity environment.

Orbital habitats may have similar problems with in situ power production. Consider, for instance, the solar arrays used to power Skylab. Even though the arrays were not incredibly large, whenever a spacecraft approached to dock with the space station they would sway back and forth as if in a strong wind. The high rate of transportation activity likely in the vicinity of a larger future habitat might prove disruptive to large solar arrays and hence make them impractical. Keeping large structures of this sort in a relatively undisturbed area and beaming the power elsewhere might prove to be the best way to overcome such problems.

Large lunar bases of the future (as well as bases on other planets) might also have a need for beamed power. Though abundant materials for fabrication of solar cells are available on the lunar surface, power is only available from a given array for 14 days out of every 28. It may be that to provide consistent power to a base even during the lunar night, orbiting power stations may be the cheapest solution. Another possibility might be that power generated during the lunar day could be sent to the opposite side of the moon via an orbital relay.

The last long-term market of note for space would be in space transportation. It may be that the solution to low payload ratios for interplanetary journeys and even to launch from planetary bodies is to avoid carrying around a useless energy source. If beamed power can make moving around the solar system more economical, by whatever methods, the potential market would be immense.

All this is just so much speculation, however. It is difficult to guess what the potential markets for beamed power will be even 50 years from now. Predicting the markets over a hundred years in advance is well-nigh impossible. Predicting the markets for Earth may not be quite so hard, however; at least there we have several thousand years of experience to draw on.

Long Term Earth Applications

For long term Earth applications of space solar power, we consider the 2040 through 2100 time frame and assume that power delivery by space solar power to the electricity grid can be done on a large scale, typically gigawatts. In these cases space solar power is fully replacing currently used resources, and meeting both baseload and peakload demands should be assessed. For data on the future predictions used in this section we refer to Chapter 2.

Segmentation of the long term market shows two main elements:

- remote developed locations
- electricity grids with baseload and peak power

In the long term, we assume energy use is more evenly spread over the globe than today and relaying from one location to another will be less possible, since power is largely used everywhere and "remote" locations with cheap energy resources would be scarce. Electricity grids are installed everywhere, except for the remote locations in Arctic or polar regions: these are still expected to be inhabited by few people. Also the remote developing locations near the equator are expected to vanish in the longer term, with grids being installed in these places. We describe these segments hereafter, at first summarizing the results of our analysis and then giving justifications as applicable.

Remote Developed Locations

The remote developed locations maintain their characteristics of short/mid term, that is power demands are from 600,000 through 7.5 million kWh per location per year, with a price (at present value) of \$0.22/kWh in general and \$0.58/kWh for Arctic regions. The total number of these locations is expected to remain quite stable.

Large Scale Power Delivery

The large market in this case are the electricity companies which operate the electricity grids, which presumably have been gradually established in the presently developing countries as well as in they are established in the developed ones. Prices are \$0.05/kWh for baseload and \$0.10/kWh for peak load. Market size will be within the range of $40 \cdot 10^{12}$ kWh through $150 \cdot 10^{12}$ kWh per year. Further, this market requires a very high reliability of the power source, both in availability and performance.

Predictions are given for the development of the market size, and because long term predictions can easily be unrealistic, ours will be based on a low and a high scenario. The actual market size should fall within the high and low estimates. To assess the long term market for electricity the following assumptions apply:

- predictions for world population and global energy demand are as per section 2.1, with the total energy demand for 2100 being $120 \cdot 10^{12}$ kWh for the low scenario and $300 \cdot 10^{12}$ kWh for the high scenario
- basically 30% of the total energy currently produced is generated electricity (refer to Chapter 2); this percentage is expected to remain constant for the low scenario; for the high scenario this could grow to 50%
- as average present end-user price for electricity we use \$0.10/kWh at 1992 economic conditions; lower in the USA and higher in most European countries
- delivering one kWh baseload power to the electricity grid gives 50% of the end user price, i.e. \$0.05
- for peak power the price is double that of baseload power, i.e. \$0.10/kWh. We assume here that peakload is from 07:00 to 10:00 (a.m.) and 17:00 - 21:00 (p.m.)
- approximately 50% of the total installed power capacity is baseload, the other 50% being peakload power. Hence, 20% of the total electric energy demand (in kWh) is during peak load.

The result is the figure below, showing low and high scenarios of the global electricity market from present to the year 2100.

In the low scenario, global electricity demand grows to $40 \cdot 10^{12}$ kWh (30% of the total predicted $120 \cdot 10^{12}$ kWh), roughly double the present size. In the high scenario the global energy demand grows to $300 \cdot 10^{12}$ kWh, with electricity growing to a 50% market share giving a global yearly market of $150 \cdot 10^{12}$ kWh (7 times the current size). Of this 20% is for peakload times. It is unlikely that the actual value will be outside these limits. In monetary value, the total electricity market by the year 2100 would be within the range of \$2400 billion through \$6300 billion (baseload and peakload accounted for).

The constellation of 120 solar power satellites of 5 GW SPSs each will deliver a maximum power of 600 GW to the power grid, with a yearly total of $5 \cdot 10^{12}$ kWh (600 GW x 95% loading x 8760 hrs/year). This would give a market share for space solar power ranging from 3.3% to 12.5% by the year 2100, which seems reasonable if such a large system would be established.

Future Global Electricity Market

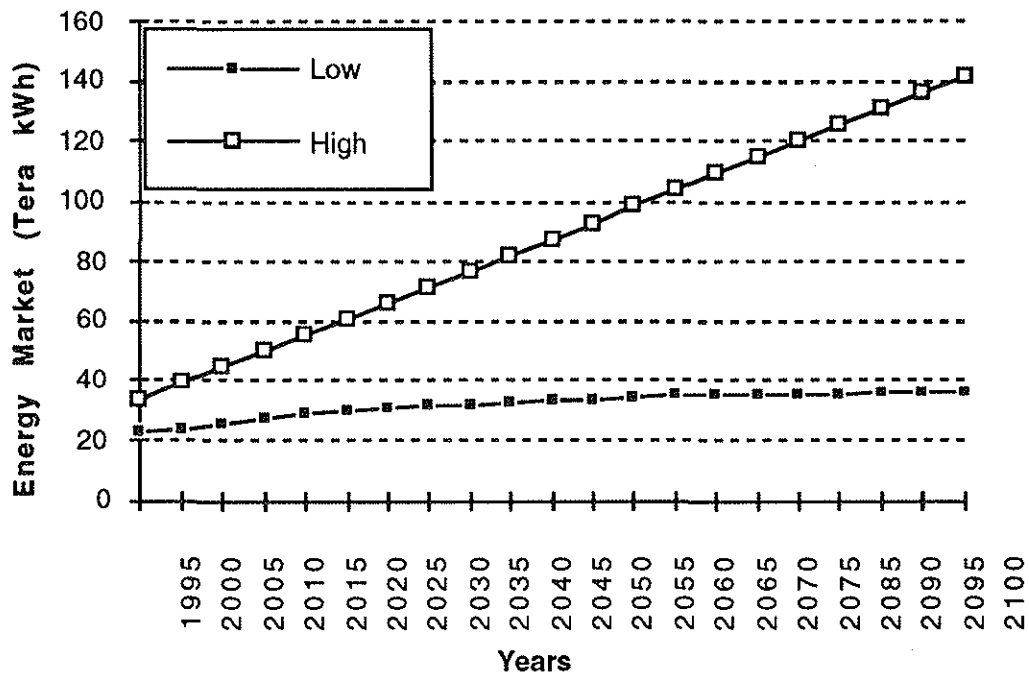

Figure 3.3 High and Low Predictions of Global Electricity Market

3.2 Marketing

The marketing strategy for the space solar power program will be applied to both the near term demonstration application, and mid- and long term commercial applications. This strategy will be based on the following five elements and their implementation:

1. Product identification
2. Players involved
3. Potential/spin-off determination
4. Pricing strategy
5. Publicity/promotion implementation

Each of the above five elements and their approaches are discussed below:

3.2.1 Product identification

The first stage of the space solar power program marketing strategy is to achieve understanding of the product to be marketed or the types of products to be marketed. There can be three distinct possibilities for the product to be marketed from the space solar power program:

- a. a microwave beam generated by a GEO orbiting solar power satellite aimed towards a customer's rectenna for their consumption
- b. electric power generated as an output from a terrestrial rectenna
- c. managed, transmitted and distributed electric power to end users

The first of the above products would result from a demonstration of microwave beamed space-to-space power for powering the solar arrays of existing communication satellites. A market exists for rejuvenating the life of expired satellites or providing additional power to communication satellites during the eclipse period of their orbits. This is the product which will be available from the smaller solar power satellite resulting from the near term demonstrations.

This would be a product possibly available in the short term within ten years. As pointed out above, since this a space based application, potential users are communication satellite companies, government space agencies and scientific organizations requiring the benefit of solar power for space research.

This second type of product would be that available from a mid-term application. It would enable space power satellite technology to develop a market niche in order to prove itself and secure the time needed to achieve the economies of a larger space solar power program. Given that this type of product would be available close to the end user, such as in the Antarctic, such a market niche would include the economic benefit of having higher cost per kilowatt-hour for conventional generation thus making satellite power economically competitive early in its development phase.

The development time for this product is in the thirty to forty year time period. Potential customers for this product include organizations requiring large amounts of localized electric power for which a power distribution network is not required. A requirement of the application of this power would be that the users would have to be willing to locate large rectennas on or near their property and land for localized usage. These customers will probably include large manufacturing companies, heavy specific users like aluminum smelting companies, and remote residential locations in third world countries.

This third type of large-scale power distribution would involve building the necessary power management and distribution networks with its inherent high costs. This would be long term development of solar power in the fifty year or greater time period.

Any new product, technology or new energy source requires a way to enter the market place. Energy from space is no different than the copier, the railroad or the oil industry in this regard. The question is what should be the market strategy for space solar power program given the entrenched and vested interests of the various "conventional" energy sources such as oil, coal and nuclear in the industrial nations and advocacy groups. The marketing strategy for the terrestrial use of a space based solar power demonstration could be targeted to highlight benefits obtained from space. Some of these are:

- The need to limit hard currency expenditures for diesel fuel for generators to Antarctic.
- The technology is capable of being scaled in a modular fashion and can thus be fit to needs (above a certain power density)
- The use of energy from space would provide a socially acceptable alternative to diesel thus greatly limiting the environmental damage.
- Low maintenance costs.
- No fuel requirements.
- High reliability due to fewer moving parts.
- Long lifetime of power systems.
- Lower life cycle system costs (to be calculated)

What are the competitive technologies? Currently, oil, gas, coal, hydroelectric and nuclear power all compete in the power generation market. Within the rural markets of the third world, there is competition from biomass which is rapidly being exhausted. For remote, isolated sites, diesel

generation is being replaced by terrestrial photovoltaics and wind. The last two choices are highly dependent upon the climate.

Burning fossil fuels for power generation has a very adverse impact on the environment. Fossil fuels also require a never ending source of hard currency.

It is doubtful that nuclear power can either be scaled up or will be allowed to completely replace fossil fuels given public concerns about safety and waste disposal. In addition, the technology required to build and operate nuclear plants along with the foreign exchange needed to purchase them probably precludes many of the developing nations from utilizing nuclear energy as an alternative to fossil fuels.

Conversion to energy from space, if we can overcome the hurdles, will become economic since oil reserves are being depleted, acid rain from coal continues to poison lakes and oceans, and global warming from CO₂ buildup is increasing. There are no easy choices but space solar power program appears to be one of the better ones.

3.2.2 Players Involved

The cost and lack of a market niche defeated previous proposals to build satellite power systems. The solar power satellite of the 70's may have been a victim of its gigantism. Since it was huge in scale, it may have posed a direct and immediate threat to special interests such as coal, nuclear power and private utilities. Given the developing public distrust of huge government programs, like the Vietnam war and nuclear power during the 1970's, the lack of support, almost resistance, from competing interests doomed the 5 to 10 gigawatt systems and a \$100 billion R&D effort proposed by the aerospace industry in the late 70's.

In order for satellite power systems to become a viable energy option, an appropriate market strategy would have to be found where it does not directly threaten vested interests or overly alarm the population and provides humanitarian and environmental benefits. The market strategy must also allow or demand tangible, visible successes every few years.

There is a great deal of similarity in the problems facing market penetration by solar power satellites and terrestrial photovoltaic technology. There is a perception that PV technology is a technology of the future and is too expensive. This is the same perception which plagues the space power satellite concept. However, at least terrestrial solar electric occasionally gets mentioned in the popular press as an energy alternative. We have a long way to go to create public awareness of the space power satellite energy option.

If advocates of solar power satellites continue to insist upon \$100 billion research programs, 5 gigawatt satellites and multi-billion dollar lunar power systems without offering the public a path of gradual steps, the public will not finance their technological fantasies. This unwillingness on the part of advocates to begin small and drive to the successful completion of a small, perhaps even technically primitive and non-optimum demonstration is perhaps the biggest hurdle facing space power satellite. If we cannot overcome our desire for technological gigantism, space power satellite will once again have to fight a tough battle for funding.

The companies and personnel needed to develop satellite power systems are for the most part the same as those needed to build defense products and facilities. However, any new major space program, in order to have the support of the public and politicians, will have to reach beyond the space agencies and aerospace companies. New coalitions will have to be formed with other industrial partners, the scientific community and government agencies. Some of these new partners may even have to be given the lead if the concept is to win through the maze of special interest groups.

3.2.3 Potential/Spin-off Determination

Large scale projects are usually not carried out by one but by many companies. This will have a social, technological and economic impact to these suppliers like electrical, electronic and designing companies. An entire second infrastructure of enterprise (service or equipment providers) is needed. These companies will benefit from taking part in our project.

As an example let us focus on labor requirements of various technologies. There is an estimated average number of people on site (rectenna) during construction and operation time required. For a long term project (5 GW) we assume that we need 3000 persons/year for about 2 years for

construction and then about 450 persons/year for operating and manufacturing. Families would be relocated with some of the workers, which increases the population of the surrounding area. This results in a higher amount of services (e.g., water, food, housing, schools) being needed.

The development of technologies to carry out the large scale project will provide new aspects to different fields. These spin-offs can be either technical or social.

With more ingenious technology and knowledge, several of the Earth's problems that have defied solutions for centuries will now be solved. Developments in the areas of transportation of energy and large-scale construction will provide us with technological spin-offs like the production of new materials necessary for construction. Materials with less weight, more strength, and non-corrosive, highly resistant, virtually unbreakable, thin-walled materials will have a great value for industry. The knowledge how to produce such things can be sold, what may reduce the price of energy coming from space power program. Such materials produced en mass can provide for example a solution to the housing problem in developing countries.

The improvement of solar cells and photovoltaics in general will give us the opportunity to use solar energy on Earth in a more efficient way. In order to store the energy converted from the power beam we may have to look for better energy storage means. The improvement in storing energy in an efficient way can be used in many other areas, for example stronger batteries for electric cars.

A social spin-off is the improvement of people's life style, through the easy availability of energy in developing countries. Another potential of carrying out space solar power program will be a general social improvement in the life-style of mankind. Some of the benefits will be: trans-national development through carrying out the project in an international group. People's common interests and goals and will learn to understand each other. An increase in communication and remote sensing will provide, in developing countries, basic and better information for the population, necessary for their survival and development concerning health, family planning and technological breakthrough. Already a great number of medical applications of space industrialization are finding their way into our lives, such as lasers or automated body-monitoring devices. In the future this will increase and will provide us more benefits.

3.2.4 Pricing

The economic viability of the Space Solar Power Program will be dependent upon the costs, the economy and the price of alternative conventional and other future power systems. The price of electrical energy is composed of many elements. In order to realize the factors creating the price of electrical energy, let us take the New York State Electricity + Gas Corporation in 1990 [Leaflet, 1990]. They spent their revenue as follows:

Table 3.3 Revenue of New York State Electricity and Gas Corporation Spent, 1990

Fuel to generate electricity	18%
Taxes	16%
Materials and services	15%
Interest payment	12%
Depreciation	10%
Employee wages and benefits	10%
Natural gas purchased	8%
Common stock dividends	8%
Retained in business	2%
Preferred stock dividends	1%

A big amount of their revenues are used for the financial area. The price of electricity largely depends on wages, interests and taxes. For marketing our product successfully it is necessary to take each possibility influencing the price into consideration.

If government owns the power providing facility it can influence the price of energy and so may encourage a certain development (environmental aspects). Government may use monopolistic the position and fix the price itself according to the intended policy. This of course prohibits fair competition and a health development of the market. On the other hand government is able to

stimulate and control the market or push the economics. The reason for this influence can be educational, when unattractive steps are necessary for development.

Another great influence on the price is the bias between producer and customer. This fact has to be evaluated and calculated. The price is not objective and can be set lower as it is supposed to be. The remote sensing industry is a good example for it. The US government has transferred the LANDSAT system to EOSAT in order to "commercialize" the LANDSAT system. EOSAT is a joint venture of GM/Hughes and General Electric Corporation. [US Department of Commerce, 1988] This system is heavily subsidized by the US government, which is also the major consumer of EOSAT data. The reason for the support by government is to expand the market and raise interest in data for private industry. Through this support the price can be reduced and the data are more reasonable. The influence of politics on the price is obvious.

The main factors which may cause the price of energy are supply, demand and economic factors. The balancing mechanism is illustrated schematically in the Figure 3.4. [DOE/ER-0099, 1981]

The demand curve shows the basic relationship between price and quantity of demand. If the price is high, only a few ask for energy, but when the price is low the quantity of demanded energy increases rapidly. The demand is also influenced by the economic activity of the country and by the energy intensity of its economy (elasticity of demand).

The supply curve expresses that there are only a few suppliers when the price of energy is low. When the price rises, the number of suppliers increases. This curve is influenced by supply constraint due to health, safety, environmental and other limitations.

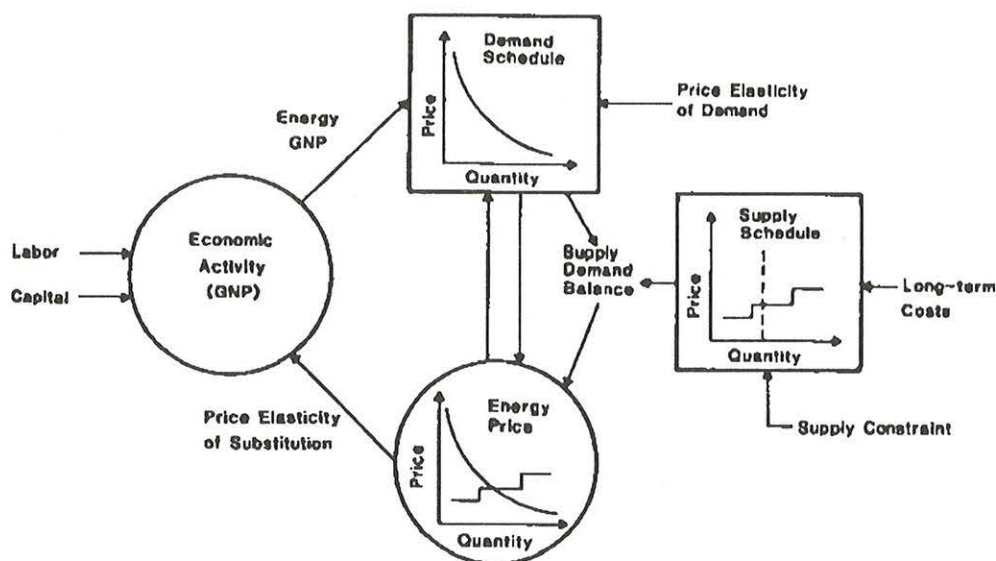

Figure 3. 4 Simplified Macroeconomics Model of the Interaction between Energy and the Economy

When we fit these two curves together we can see the relationship between price, supply and demand. When the price of energy rises, the expected response in a market economy is a further decrease in demand, together with increased supplies. The demand for energy also decreases when price increases, especially if there are less costly alternative ways to acquire energy. The number and kind of available alternatives depend on the rate of technological progress. New products and technologies tend to displace current products and producers, for example power generating companies, oil and gas selling companies. Assuming that there are many other suppliers the competition among them might be aggressive. This influences the price and it might result in a ruinous dumping. The optimum for the price is where the demand and supply curve intersect.

Price Estimation

In order to estimate the price of energy there are several mid- and long-term energy/economic models which have an optimizing scheme to project prices into the future depending on capital

investment, future energy demand, assumed GNP growth rate and other parameters of the economy. For example let us mention the price elasticity of demand, the degree of effective constrain on energy imposed for health and safety, and the price for energy from other alternatives. With these models it is possible to compare projection for different energy prices. Through it is not possible to predict the correct price, higher, nominal and lower levels are predicted in which the price may range.

Figure 3.5 below shows the price estimation for the time range between the years 2000 and 2030. Prices for current available energy alternatives can be predicted quite good. They will be about 25 to 40 million dollars (1978)/kWh. If we assume an inflationrate of 5% per year we get the prices in 1992 mills/kWh. Therefor the prices will be between 50 and 80 million dollars (1992)/kWh.

To predict the prices for future energy sources like fusion and terrestrial photovoltaic is more difficult . A high level of uncertainty creates a wide range for its possible price. The price might be in the timeperiod of the years 2000 to 2030 between 30 and 200 million dollars (1978)/kWh (1978).

It is very difficult to give exact figures for the development, because the price depends on many factors which cannot be exactly estimated or are even unpredictable. In order to be competitive, the price of energy used on Earth coming from solar space power program should be in an range which is close to the available alternatives.

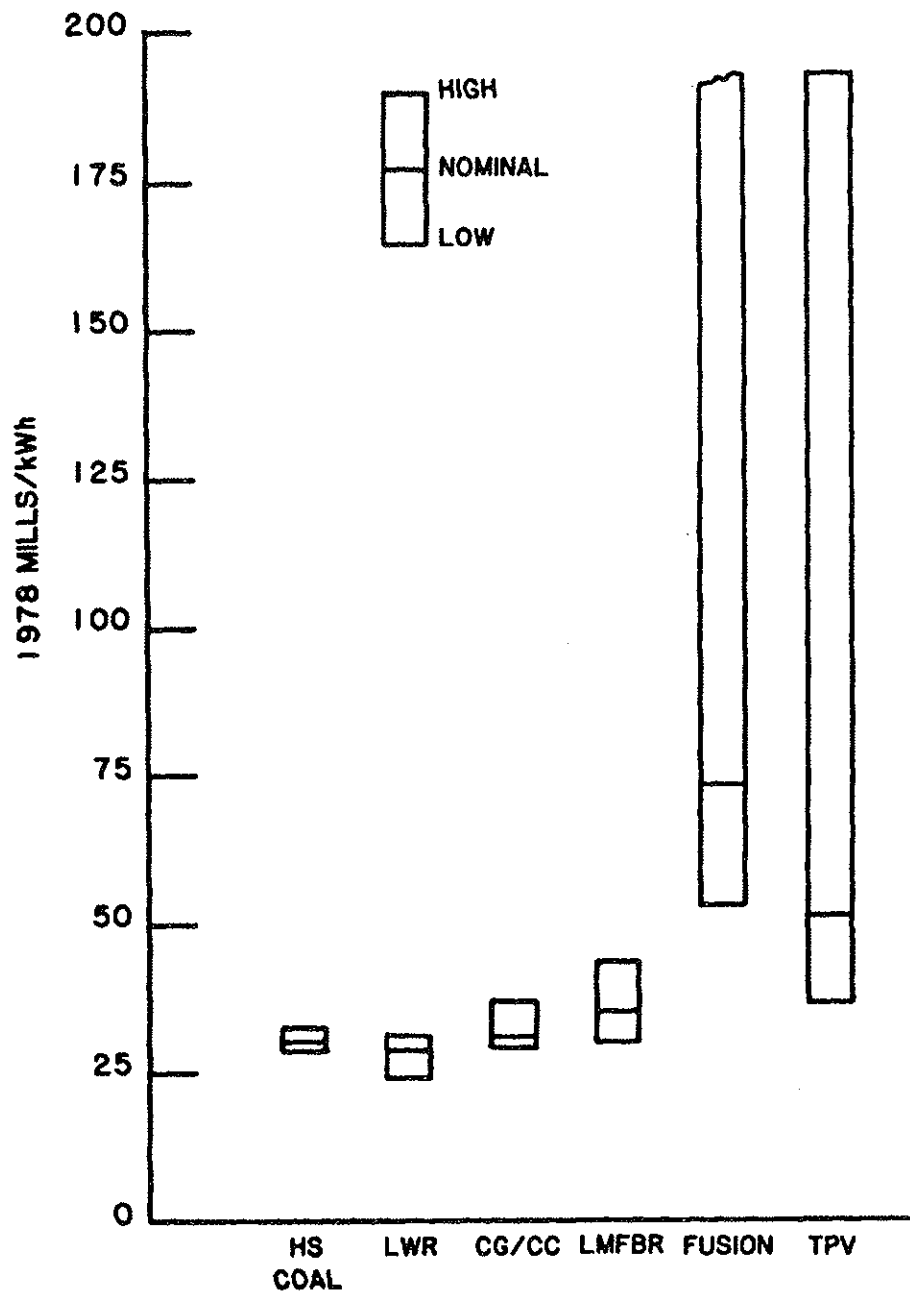

Figure 3.5 Energy Cost Ranges for Different Power Generation Processes [DOE/ER-0099]

3.2.5 Promotion & Publicity

To sell the Space Solar Power Program we need to create a win-win situation. We need to emphasize the social and environmental impacts. These include the benefits and rewards of a cleaner, reliable, and abundant source of energy. We must introduce and enhance visibility and acceptance of the Space Solar Power Program. And we need to target all the players; the general consumer, the scientist, the engineer, the financier and the policy maker.

The general consumer is the largest group and also the most conservative of the players. Because of the diverse cultures and education of individuals in the group, the promotion must be treated in a similar to selling a refrigerator, a can of coke or a lottery ticket. It must be simple and moreover rewarding in use, taste or benefits.

For the scientist and engineer, the promotion must be more specific and in line with advocating advances in science and technology. They are technically educated and as such most often introduce skepticism in their thoughts. The program should not only be dedicated with a defined budget but must be approached successively with milestones to measure of the progress. These milestones should be marked with demonstrations and not paper studies. Demonstrations are more tangible and encourages support from individuals.

For the financier and the politician, the promotion must be towards the potential rewards to their shareholders and constituents. They must answer for their actions and therefore must be convinced of the potential benefits. The process of reaching the results is not as important to them as the product/result.

The first step in the promotion of a space solar power program to project an image. A win-win image for the space solar power program should be instilled and graphically advertised. Even in the infancy of the program, small successes or rewards must be presented. The milestones should be short, frequent and strategically predictable. These will help serve to build a strong relationship between the players and space solar power program. Positive successes will eventually lead in establishing a track record. Frequent and predictable successes will help gain public support. Take the example of Apple, the increased use of their computers has been from their image of user-friendliness and competitive price. The mouse and icon format has made a complicated system easy to use. In the price, the initial development cost was absorbed through high unit production and the cost spread out over time.

Product identification through logo's, design, colors, etc. provides a tool for the program to network with the public. This enhances the exposure and recognition of space solar power program. As people begin to see advertisements and billboards carrying the insignia, people will begin to communicate and exchange their feelings of the product. As dialogue about the product develops, a communication chain reaction (domino-effect) may ultimately achieved. This mode of transmittal is the most effective in that it reaches the household more directly and more personally.

The partnership must be universal and all-embracing with the players. As with all partnership, it will be a process of give and take. The ideas must be flexible and non-offensive to anyone. We must not take for granted any of the players. They are all part of the space solar power program as we would like space solar power program to be a part of them.

We must enhance awareness not only through advertisement but also through dialogue in classrooms, workshops, and hotlines. Education stimulates, encourages and brings greater acceptance and moreover proponents. The support structure can only become stronger when the level of understanding is high.

3.3 Marketing and Financing Schedule

The activities concerning marketing and financing have to be prepared over a rather long period in the future. This section deals with how these activities have been scheduled and how they link to the overall program.

The explanation for the figures of this section and the symbols used in them is given in Appendix G. This explanation is required to understand the following. The only addition to this is that the finance resource of each of the funding stages is mentioned in the lower left corner of the marketing boxes of Figure 3.6a.

Figure 3.6a presents a task schedule with tasks, milestones, dependency lines and durations. There are six phases to be seen in this schedule. Each phase has a certain amount of subtasks which are more or less the same. In order to keep the overview understandable these have been put in

Figure 3.6b. The phases themselves fit together with the terraced schedule which is presented in Chapter 4.

The division in phases is such that they have no very clear end or beginnings, but merely flow over in each other and as such many activities are conducted in parallel. The reason for this is to increase the efficiency of the overall program and to maintain the experience that is built up during the several phases. The reasons for the specific durations are explained in the according chapters. The duration of the final stages is explained in the overall schedule in Chapter 4.

During all the phases a continuing fund raising and marketing analysis will be conducted. This is required to fulfill the tasks for the Space Solar Power Program. Their peak activities however will lie within the boxes in Figure 3.6a, especially assigned to these activities. This means that during the specific design phases of the demonstrations, the fundraising activities will increase. They are related to the technology and development demonstrations, and are split in two parts as shown in Figure 3.6b. The initial fundraising with the help of a first created proposal will enable pre phase A studies, which are the least expensive parts of a design project. The second part of the fund raising will take place after the initial feedback of the previous demonstration phase. This will give the fund seekers more credibility and a better basis to convince potential funders and to supply the program with funding recourses. This special fundraising will continue during the entire phase of the demonstration. After launch these activities will decrease drastically, although they still have to fund the operation of the spacecraft involved and the evaluation. In the end they will have to continue at a constant level when the large demonstrations begin, culminating in the fully commercial system.

The first two phases form the near term demonstration phase where space to space and a space to Earth demonstrations will be present. There will be no commercial viability or business applications in this stage of the project. The funding therefor depends on governmental institutions. The next stage is the phase where a one megawatt demonstration is scheduled. Here the first business application is expected, although there will be no return of investment. In the fourth step a demonstration in the order of 500 megawatt is expected. This will enable a commercial return and the investors will shift from the governmental institutions to industry. Table 3.4 gives the source for funding which is referred to in Figure 3.6a, in the lower left corner of every box. During the fifth stage where the first large solar power station will provide gigawatts, the program will evolve into a commercially feasible one. In the sixth stage there will be mass production and maintenance, controlled by industry and long duration investors. This is explained in more detail in Chapter 10.

Table 3.4 Funding Sources for the Space Solar Power Program

1. Space funds	9. Public Energy Companies
2. EEA/EPA	10. Shares in Space Power
3. Advertising	11. Bonds
4. Developing World Aid Funds	12. Venture Capital
5. IMF	13. Banks
6. UN	14. Life Insurance
7. Futures in kWhrs	15. Pension Funds
8. Oil Industry	

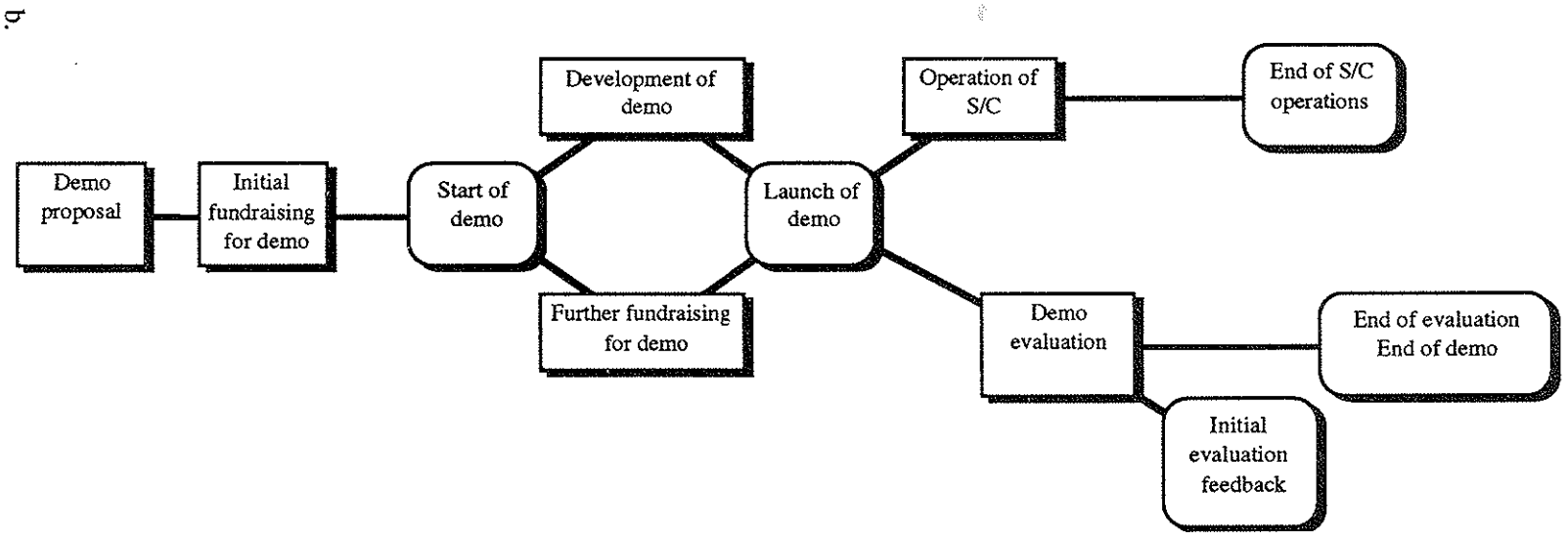
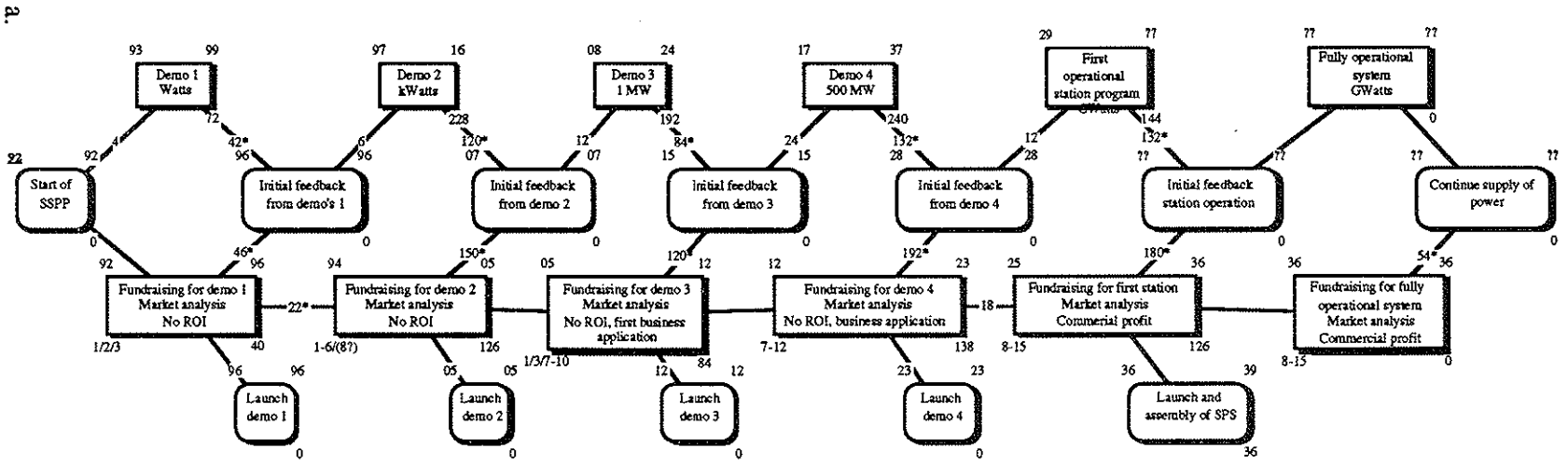

Figure 3.6 a.) Marketing Schedule b.) Marketing Subschedule Tasks

References

- Brauch et al, U, "Solar Pumped Solid State Lasers for Space", Space 91 Proceedings, 1991.
- Landis, Geoffrey A, "Photovoltaic Receivers for Laser Beamed Power in Space" Preprint 1992.
- Leonard, R.S., A different race: Global Rural Electrification, Market Niches, the Third World as a starting place for SPS, Proceedings of Second International Symposium 'SPS '91 Power from Space', Paris, p. 114, August 1991.
- Brown, A.M., Center for Space Power, Wireless Power Transmission, The Technology and Its Applications, International Space University Summer Session 1992.
- Cummins, A.B., SME Mining Engineering Handbook, edited by I.A. Given, v.2, section 23.8, pages 23-40 through 23-45, Port City Press, Baltimore Maryland, 1973.
- Brandhorst, Henry, NASA Lewis Research Center, personal communication, 1992.
- Chetty, P.R.K., Satellite technology and its Applications, 2nd Ed., TPR, Blue Ridge Summit, PA, 1991.
- Eurospace, Powersat Study, ESA Contract N° 9390/91/F, 1992.
- Hertzberg, Abraham, and Kenneth Sun, "Laser Aircraft Propulsion", Radiation Energy Conversion in Space, Prog. Ast. Aero., vol 61, AIAA, NY, 1978.
- Madry, Scott, ISU 'Satellite Applications Lecture Notes, 7.06 & 7.07, "Introduction to Satellite Communications, Space Segments and Payloads", 1992.
- O'Donnel, Patricia NASA Lewis Research Center, personal communication, 1992.
- Palaszewski, B., "Geosynchronous Earth Orbit Base Propulsion Options," AIAA paper 87-2022, May 1987.
- Palaszewski, B., "Electric Propulsion for Lunar Exploration and Lunar base Development," Symposium on Lunar Bases and Space Activities in the 21st Century, LBS-005, April 1988.
- Pidgeon, David, et. al., "Mass and Power Modeling of Communications Satellites," NASA Contractor Report 189186, 1991.
- US Department of Energy, An Assessment of the Satellite Power System and Six Alternative Technologies, April 1986, DOE/ER-0099.
- Verity, C. William ,US Department of Commerce, Space Commerce an Industry Assessment, May 1988.
- Zabel, Bernd, Biosphere 2, personal communication, 1992.
-

4 Overall Development Plan

This chapter presents a program development plan for understanding and managing the overall space solar power program. An attempt was made to compile both technical and non-technical issues that need to be addressed in a phased program in order to make a space solar power program a reality. This chapter links previous background and marketing chapters with subsequent discussions of environment & safety, external relations, organization, technology development and design project examples. A program schedule which addresses all aspects of a space solar power program is also presented.

4.1 Program Requirements

Figure 4.1 shows the top-level requirements for successfully implementing a space solar power program. These requirements are derived from the need to answer basic questions about the program's technical feasibility, eventual business viability and its public, political and social acceptability. To be successful, the program must meet all of these requirements.

The program requirements shown in Figure 4.1 are taken to the next level of detail in Table 4.1. This process of refining program requirements can be successively applied until very detailed and specific requirements are defined. Both technical and non-technical program requirements (i.e., business, environment & safety and political & social) are developed further in subsequent chapters of the report.

Program scheduling transforms requirements into identifiable tasks, milestones, etc.. In the case of a space solar power program, extreme care must be taken to insure that both technical and non-technical issues are addressed together in a phased manner so that program resources can be allocated in an efficient and timely manner. Program scheduling is addressed in detail in section 4.6.

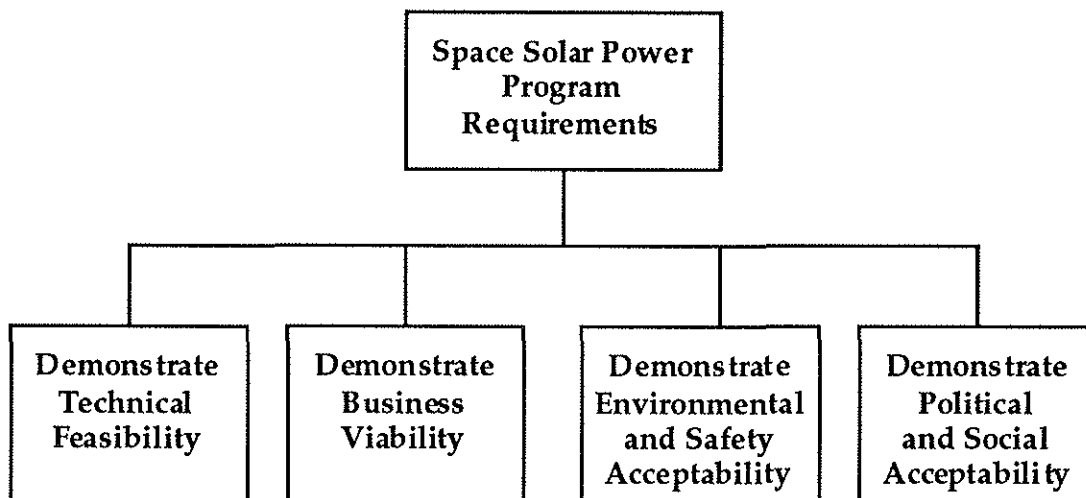

Figure 4.1 Top-Level Space Solar Power Program Requirements

4.2 Identification of System Drivers

The requirements introduced are not equal in their potential impact on the program. This section of the report identifies technical and non-technical requirements that drive the program. In section 4.2.4, these driving requirements are linked together to show the flow of the requirements from the program level to the hardware level.

Table 4.1 Space Solar Power Program Demonstration Requirements

<ul style="list-style-type: none"> • Demonstrate Technical Feasibility <ul style="list-style-type: none"> •• Demonstrate Spacecraft Technologies <ul style="list-style-type: none"> ••• Demonstrate Spacecraft Bus Technologies <ul style="list-style-type: none"> - Demonstrate Engineering Scale Up - Demonstrate Controllability <ul style="list-style-type: none"> -- Guidance, Navigation & Control (Attitude and Vibration Control) -- Thermal Control - Demonstrate Deployability/Assembly/Constructability - Demonstrate Maintainability and Damage Control ••• Demonstrate Power Collection & Conversion Technologies <ul style="list-style-type: none"> - Demonstrate Collection of Power - Demonstrate Conversion of Power - Demonstrate Remote Transmission of Power <ul style="list-style-type: none"> -- Quantify Beaming Losses -- Verify Beam Accuracy •• Demonstrate Distribution Technologies <ul style="list-style-type: none"> ••• Demonstrate Rectenna Operation ••• Demonstrate Integration with Existing Power Grids ••• Demonstrate Reception from Multiple Transmission Antennae • Demonstrate Business Viability <ul style="list-style-type: none"> •• Demonstrate Marketability <ul style="list-style-type: none"> ••• Niche and Emerging Markets ••• Alternative to Existing Energy Options •• Demonstrate Ability to Secure Financing <ul style="list-style-type: none"> ••• International & Governmental Funding ••• International & Governmental Loan Guarantees ••• Private and Institutional Investors •• Demonstrate Cost Competitiveness <ul style="list-style-type: none"> ••• Reasonable Development Costs ••• Reduced Transportation Costs ••• Reduced Construction Costs ••• Minimal Operational Costs ••• Overall competitive pricing with existing power options • Demonstrate Environmental and Safety Acceptability <ul style="list-style-type: none"> •• Verify Environmental Impact •• Demonstrate the Safety of Power Beaming <ul style="list-style-type: none"> ••• Power Beaming Accuracy ••• Effects on Humans and other Biota • Demonstrate Political and Social Acceptability <ul style="list-style-type: none"> •• Demonstrate Public Acceptance •• Demonstrate Political Acceptance <ul style="list-style-type: none"> ••• Develop Infrastructure for International Cooperation ••• Develop a Mechanism for Handling Technology Transfer Issues ••• Provide Assurance for Non-military Use ••• Obtain Frequency and/or Orbit Slot Allocations ••• Consider Lunar Resource Utilization ••• Address Orbital Debris Issues
--

4.2.1 Political and Social

The political changes in the world during the last few years (breakdown of the former east European socialist societies, political changes in other communistic influenced countries) may be considered as one of the main system drivers for the Space Solar Power Program. The main political conflict of this century, the confrontation between the democracies and the socialist societies, has been ended and so the most important driver of the political development does no longer exist. With this development, the governments in all countries begin to spend less money for the military sections of the industries which results in the beginning of a recession of this sector. The military complex of the industry has to reduce its effort for the development of new systems and the conversion of the military to a

peaceful production becomes the alternative for their future activities. Beside the environmental research the space research is one of the most promising activity for the highly educated and motivated scientists and engineers working in the military research sector. Such a long term program like the Space Solar Power Program ensures employment and profit over a long period.

As the former East-West conflict changes into an East-West cooperation the North-South conflict between the developed countries in the northern hemisphere and the poor countries in the southern hemisphere will get much more interest in the political arena of the world. The growing problems in the developed countries due to immigration and refugees force them to deliver much more help (political and financial) to the undeveloped countries in order to give them more possibilities for the solution of their problems within their countries. As most problems arise from the low standard of living in these countries one promising possibility of the developed countries and the Space Solar Power Program is to create jobs with the growing industry on the basis of the delivered electrical power and for the personnel maintaining the power receiving stations in the undeveloped countries. Employment increases the standard of living in these countries and protects them from emigration.

As most of the developed countries have no great resources for energy production (oil, coal) they depend on the continuous supply. The oil crisis during the seventies showed, that this dependence can generate problems, if the delivering countries use the energy sources for political and economic pressure. In order to overcome such problems in the future, the Space Solar Power Program can prevent such a dependence and can therefore get great support by the governments of the developed countries.

In spite of the fact, that we don't know how long the energy demand of the Earth can be satisfied by the traditional energy sources (oil, gas, coal etc.), we know, that the total amount of these materials is limited on Earth. Most of these raw materials can also be used for very useful purposes, like the chemical industry producing plastics. Any effort to use the solar energy and to protect the raw materials will be supported by the public and the governments as long as the price for the energy will not change. In addition the price of the raw material will rise as soon as the continuous supply will not be secured, leading to a higher price for the energy produced from it (section 4.2.3).

4.2.2 Environmental and Safety

The actual way to produce energy has to be changed for the future due to the environmental problems which are connected with the production of carbon dioxide or nuclear waste. The general public directs much more interest on the way of energy production. The development of the ozone hole in Antarctica, the Greenhouse Effect, and the Chernobyl accident lead to a much stronger environmental consciousness of the people. Governments and the industry in the developed countries have to intensify their environmental efforts and have to look for new and clean energy sources. As the clean energy sources on the Earth are limited (Chapter 2), solar energy beamed down from space is a very promising alternative which will be well supported by the general public as soon as the environmental safety is demonstrated.

The Chernobyl accident showed the possible risks of energy production, especially if nuclear power is used. The safety standard of all nuclear power plants had to be increased since then and caused higher costs for the energy production (section 4.2.3). The need of safe ways to produce large amounts of energy is one system driver for the development of all alternative energy sources. Due to the limited number of other safe energy sources the Space Solar Power Program will profit from any higher safety standard compared to other energy sources.

The growth of the world population causes a higher demand for food and energy. Many people in the less developed countries cut the trees and the rain forest in order to get wood for energy production and land for agriculture in spite of the destruction of the oxygen production and of the soil erosion. As the large rain forests are located in the undeveloped countries of the equatorial region of the Earth, the developed countries have to provide alternative clean energy sources in order to protect the rain forest and to protect the continuous oxygen production for the whole world.

Even if there are other energy sources available (fusion) there may be some places on Earth that are difficult to reach by cables or by coal/oil supply (Antarctica). In that case, beaming of energy is also the cleaner solution for power supply and the knowledge of all environmental effects might become important.

4.2.3 Business

Market. The concept of power from space has been around for over twenty years and various *potential* markets have been identified, for example orbiting platforms and large-scale power for Earth. However, because solar power satellites are only at the conceptual stage, paying customers will not emerge until these satellites move from concept to reality. Therefore, the market requires seeding through a series of hardware demonstrations. (This terraced approach to the development of a space solar power program is discussed in the next section). The "markets" in the terrace of program development will most likely progress from government/international subsidizing supporters to commercial, paying customers. The evolution of the market drives the evolution of the spacecraft, infrastructure, etc. required to meet market needs. In the next section, the market will be shown to be the most critical driving factor for projects within the overall program.

Finance. Financing is essential for the development of a new product, such as power from space. If financing cannot be secured at every step in the terrace of overall program development, then space solar power will continue to be a dream forever locked in the prison of paper studies.

Cost competitiveness. If all of the technologies for a space solar power program were available, if government and public support were strong, and even if several steps in the terrace of program development were successfully completed, the program would still fail if the power provided was not cost competitive with other energy alternatives. However, when comparing space solar power with these alternatives, the real cost of energy, as discussed in Chapter 2, must be taken into consideration, including the cost to the environment. Also, the fact that most of the currently used energy resources are limited must be acknowledged when planning for the future. All models say that energy demand is increasing and continued use of limited energy resources implies that supply is decreasing. Therefore, a long-term view for supply and demand is required when assessing the current and future cost competitiveness of energy from space.

4.2.4 Technical

The identification of technical driving requirements in a terraced space solar power program requires the consideration of non-technical driving requirements and program constraints, such as cost. At the hardware level, i.e. the lowest technical level of a program, it is essential to understand the relationship between all of the program's elements, the program's sensitivity to changes in these elements and the effects of changes on technical aspects of the program. This type of approach is required since the magnitude of projects within the space solar power program is expected to increase with time and this increase will have significant effects on hardware design. Therefore, to get to the hardware level of the program the main drivers for the design of a solar power satellite are identified. The result is shown in Figure 4.2.

The key system driver shown in Figure 4.2 is the market, which has previously been categorized as near-term, mid-term and long-term. The market requirements will vary according to category and can be found by answering the questions of:

- *How much* power is to be delivered?
- *Where* is it to be delivered?
- What is the *purpose*? (demonstration; large-scale orbital power supply, etc.)

From the market requirements one can derive the physical requirements of the system, such as orbit and frequency selection. Note that the physical requirements are also influenced by legal and regulatory constraints as well as available technology. From the physical and market requirements (frequency, amount of delivered power, and orbit) one can derive the power collection, conversion and distribution (PCCD) requirements. These requirements will drive the selection of the power generation method (solar photovoltaic, solar dynamic, etc.) and the selection of the power conversion devices. PCCD requirements will also fix the aperture product of the system, which is a function of wavelength and distance of transmission. Selection of PCCD elements, along with orbit selection, will drive the spacecraft design requirements. And finally, spacecraft design and orbit selection will drive the requirements for space transportation and on-orbit operations. Note that the process of flowing down system requirements is constrained by cost and that it is an iterative process due to uncertainty and the changing nature of the projects within the terraced program.

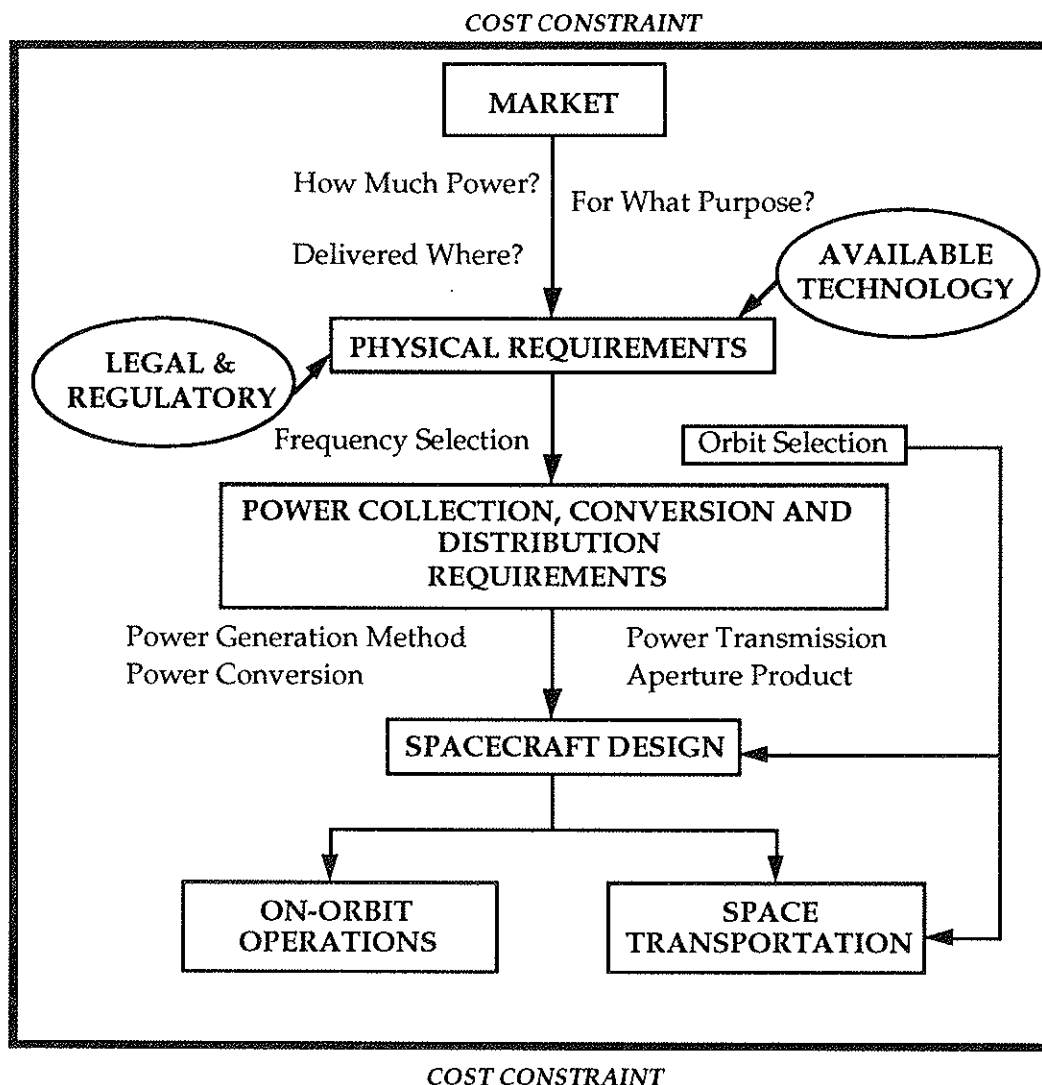

Figure 4.2 Driving Requirements for Space Solar Power Program System Design

4.3 Technology Options

4.3.1 Power Options

First a comparison of photovoltaic and solar dynamic power is made [Hamakawa, 1981]. Advantages of photovoltaics are the following

- No moving parts
- High reliability
- Long life
- No vibrations

Vibrations add an extra burden on the attitude control system. Reduction of these is significant.

Photovoltaics generate direct electrical power with constant efficiency regardless of the scale of the system and it is suitable for mass production. A disadvantage of photovoltaics is that the solar cell cost is high. Solar dynamics have the advantage of high efficiency for large scale systems, while a disadvantage is the presence of moving parts. These lead to low reliability, short life and vibrations.

It is difficult to find unbiased information about trades between photovoltaics and solar dynamics. The trade is often colored by it being made by a proponent of the one or the other system. Figure 4.3

shows a diagram which compares the cost of photovoltaic and solar dynamic systems for providing additional power to Space Station Freedom. The trade looks at the whole life cycle cost of the two systems and takes into account also the quantity of propellant that is required to compensate for the atmospheric drag. It is predicted that there will be a cross-over point in favor of solar dynamic power in 2003 [Fordyce, 1992].

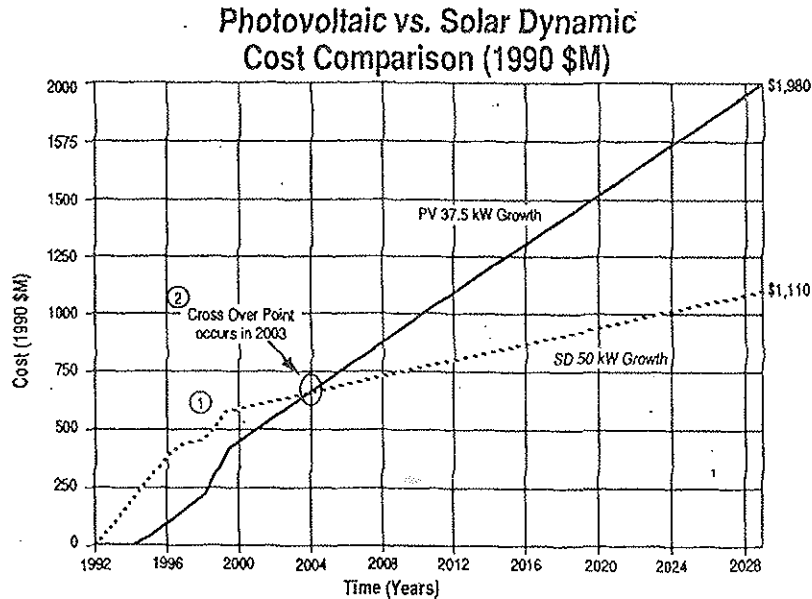

Figure 4.3 Cost of Using Photovoltaic versus Solar Dynamic Power [Fordyce, 1992].

However, another trade that was made for Space Station Freedom indicated that by taking into consideration state-of-the-art solar cell technology the result would be in favor of photovoltaics [Bailey & Landis, 1990]. The trade assumes that the Si cells, which have an efficiency of 14.2%, are replaced by GaAs/Ge cells with an efficiency of 22%. It is also assumed in the trade that the NiH batteries are replaced by NaS batteries. The result is shown in Table 4.2, where Space Station 21 refers to the GaAs/Ge-cell design.

Table 4.2 Trade between using photovoltaic and solar dynamic power for Space Station Freedom [Bailey & Landis, 1990].

Power System	W/kg	W/m ²	Technology Readiness & Issues
SP-100 (150 kW)	6.5	495	TB flight tested in 2000
Solar Dynamic (25 kW)	4.0	120	Pointing accuracy $\pm 0.1^\circ$ No flight data
Space Station Freedom (75 kW)	2.4 (4-year point)	70	Flight tested 1984
Space Station 21 (75 kW)	10.5	165	2000 production

Microwave and laser beaming are the two options for power transmission in space. The trade between microwave and laser transmission is determined by the characteristics of each particular application. Microwave transmission generally has higher efficiency than laser transmission, but in many cases, such as when beaming power to spacecraft, the large-size rectenna, which is required for receiving the microwave beam, may make it more favorable to use laser transmission despite its lower efficiency.

Microwave transmission is a mature technology and has high efficiency, up to 60%, but the long wavelength makes it necessary to go to large transmitter and receiver diameters in order to achieve efficient power transmission. Going up in frequency has the drawback of increasing attenuation of the beam in the atmosphere. Environmental and safety aspects with regard to microwave radiation put an upper limit to the power density. The availability of suitable rectenna sites, which will need to have a

diameter of 10 km or more for large-scale power transmission, will be a potential problem in densely populated regions.

Microwave beaming is challenged by laser as method for wireless power transmission. Laser transmission has the advantage of being able to achieve high power density and it is therefore possible to use much more compact receivers. The drawbacks of laser transmission is the low conversion efficiency, less than 20%, and the attenuation of the laser beam in the atmosphere. For CO₂ lasers with a laser wavelength of 10.6 μm the attenuation is 20%. The transmission is also highly dependent on the weather conditions. For receiving the laser beam, there are several possibilities, such as photovoltaics, heat engines, energy exchangers and thermoelectric laser energy converters.

For laser to become competitive with microwave transmission it would probably be necessary to greatly improve the efficiency. A breakthrough might be the development of free-electron lasers, which would have an efficiency of 50% or more. For the near future microwave transmission will in most cases remain the preferred method of power beaming, but it is advisable to continue to watch the development of laser technology as it with time may become an increasingly attractive alternative.

4.3.2 Engineering Space Technologies

Control of Space Structures

Presently, design of space structures have been limited to simple satellite designs and a few very complex design cases such as Space Station Freedom (SSF). In the future, any solar power satellite project will require a very good understanding of the vibration characteristics and the successful control of these unwanted effects. Current work in this area, such as the modeling of the vibration characteristics, use of robust control, and the Reduced Order Model (ROM)/Residual Mode Filter (RMF) design for large space structure control, have been, theoretically, successful. Research has primarily been limited to mathematical, both theoretic and computational, and terrestrial experiments, although a number of in-space experiments have been proposed and will probably be completed by the time space solar power becomes commercially viable.

Space Construction

Due to the sheer size of Space Solar Power Program, in-space construction will be necessary. This will be done either with the use of erectable systems such as truss bay assembly, or through the use of large deployable systems. Currently, erectable systems have shown considerable promise in the EASE/ACCESS experiment, but the rescue of the INTELSAT satellite on STS-61B demonstrated that the dynamics of berthing and docking might be an issue. In contracts, other areas in erectable systems such as configuration design and methods of joining have shown their maturity and have been successfully used. System maturity also has been shown in deployable systems. It is quite common in almost every satellite, to see deployable solar panels being used. Unfortunately, complex deployable structures such as antennas have not fared as well. The unsuccessful deployment of the Galileo high gain antenna, a deployable mesh type structure, demonstrated that complex deployable structures still are not up to where they need to be, although they will continue to be examined because of their many advantages. Also, new systems with new techniques and different advantages are being developed almost yearly. With all these choices, all with different advantages and disadvantages, space construction should be ready for the Space Solar Power Program.

Resources

In the near-term, it is difficult to propose a viable role for on-orbit construction, in-space manufacturing, or non-terrestrial materials within the program. However, several studies have concluded that, longer term, solar power satellites are unfeasible with only Earth-launched material and have suggested the use of non-terrestrial resources to provide material for construction. These resources could include materials indigenous to the moon, asteroids, or even refined material such as empty external tanks brought to orbit by the U.S. Space Shuttle. Analysis of the support required for such a scheme emphasizes technology development and infrastructure on the Moon. A program for developing these technologies is necessary so that we have the capability to realize the larger systems in the long term. An indigenous space resources utilization (ISRU) program can be envisioned which will be evolutionary, justify itself at each step, and demonstrate the necessary technologies for the next step. This can all be done with an eye towards developing technology to support a satellite construction project in the long term.

Longer range, it might be reasonable to consider the use of asteroids to provide material for construction. Man-made material which is currently discarded in space, such as Space Shuttle external tanks, is another source of resources in space. No matter where the non-terrestrial resources come from - the moon, discarded launch vehicles, or asteroids - there is an interaction of its use with the assembly node for the big satellites to come later. If we use non-terrestrial materials, then we probably should not transfer the material to LEO for assembly of the satellite only to have to raise the mass to a higher orbit again. However, if you are using astronauts in the construction process, the radiation protection in LEO is preferred, even if this approach is more expensive.

4.3.3 Space Transportation

The advancement of space transportation is critical to the realization of the Space Solar Power Program in going from demonstration of the technology to commercialization. Depending on the perspective, the trades for propulsion and transportation fall into three different categories.

The first category focuses on the next 10-year period and includes incremental improvements of existing technology, such as lighter-weight upper stages and higher-temperature engines. It is also foreseen that low-power electric propulsion, at levels of a few tenths of kW, will be employed.

When looking at the second category, the perspective is that of the period between 10 and 20 years from today. To the second category belong developments such as metallized propellants, technique for using aerobrake and aerocapture and reduction of propellant volume by using slush hydrogen. There are several different types of launchers which could become available during this period

- SSTO – single-stage-to-orbit, e.g. Delta Clipper
- TSTO – two-stage-to-orbit
- NASP – National Aerospace Plane
- HLLV – heavy lift launch vehicle, e.g. pressure-fed booster, so called Big Dumb Booster

It is also possible that by then high-power solar electric propulsion of more than 100 kW could have become developed.

The third category includes the developments which are considered as lying more than 20 years ahead. High energy density propellants and high-power nuclear electric propulsion of more than 100 kW belong to the third category. In the far future other types of propulsion, e.g. gun propulsion, mass drivers and laser propulsion, may become interesting alternatives.

Examples of future trades that would relate to the Space Solar Power Program are

- electric Orbital Transfer Vehicle (OTV) versus aerobrake OTV for transportation from LEO to GEO
- use of mass drivers for transportation of materials from the lunar surface

4.4 Technology Development Plan

The technology development plan presented in this section is derived from an examination of the program requirements, technology options and schedule. This plan is a chronological guide to the development of technologies that support the necessary projects and demonstrations which lead to a fully operational space solar power program (Figure 4.4).

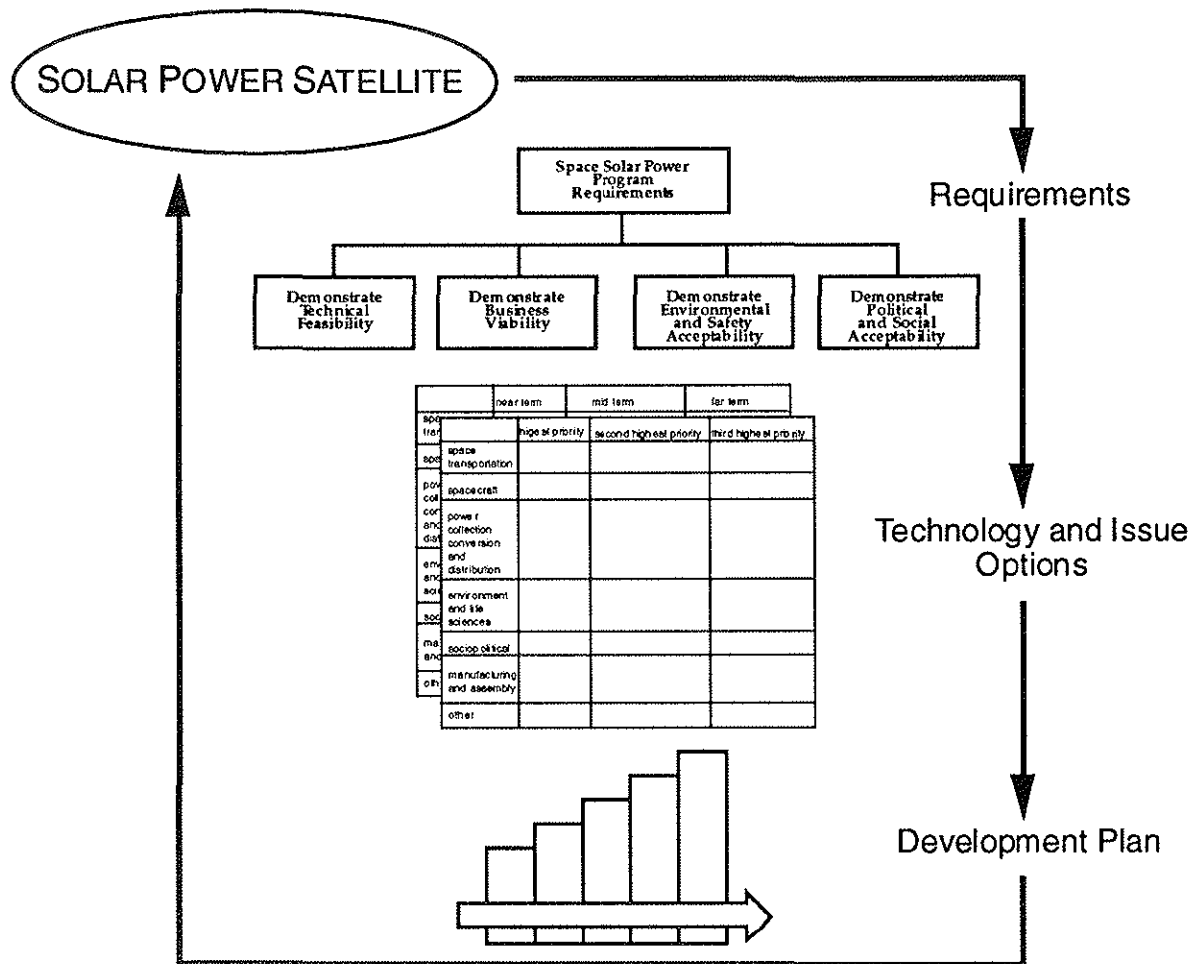

Figure 4.4 Space Solar Power Program

An operational space solar power program will deliver approximately 1 GW. The space solar power program must, besides being technically feasible, prove to be viable from a business standpoint, be accepted both socially and politically, and provide safe service whether the criteria be environmental or physiological. Tables 4.3 and 4.4 show a compilation of the technologies and main issues required for a successful completion of the space solar power program. In both tables, main issues are presented per discipline: Space transportation, spacecraft, power collection conversion and distribution, environment and life science, socio-political, manufacturing and assembly and others.

In Table 4.3 each specific issue is shown by its priority level: highest, second highest, third highest. The highest priority represents the areas where efforts are absolutely mandatory for the completion of the program. Second highest priority characterizes the issues that are highly desirable. A lack of effort in these areas will seriously complicate the implementation of the program. Finally the third highest priority depicts issues that should be investigated since they may provide significant benefits.

For Table 4.4 issues are presented as a function of time of their implementation: short term, mid-term, far term. Short term represents issues that will need to start within the next five years either to implement the first steps of the program or as the beginning of long term efforts required for the final steps of the program. Mid-term issues are the ones needed for the intermediate steps in the overall program implementation or issues that requires to be studied early before the final implementation steps (Figure 4.4). Table 4.4 is a complement to Table 4.3 since it indicates when the research and/or efforts needed to be performed.

Table 4.3 Issue Priorities

	highest priority	second highest priority	third highest priority
space transportation	reduction of ETO launch costs <ul style="list-style-type: none"> •design towards improved maintainability and operability •aircraft -type operations •improve materials and propulsion systems •develop more efficient OTV propulsion systems 	develop environmentally safe propulsion systems	minimize space debris
spacecraft	attitude and orbit control of large structures efficient radiator systems large structure resonance control	large capacity power storage high pointing accuracy (beams/antenna) maintainability over long term	large deployable structure technology
power collection conversion and distribution	development of more efficient power conversion system (phased array, efficient high-frequency, high-power transmitter, etc)	development of more efficient power collection system (photovoltaic or solar dynamics) development of efficient and affordable beam collection system	improvement in lifetime of collection system
environment and life sciences	determination of beam effects on biota (including study of different frequencies on biota) determination of beam effects on atmosphere of Earth	determination of effects of increased number of launches on atmosphere and biota determination of interference of beam (including harmonics / sidebands) on existing and future users determination of rectenna construction and operation effects on environment (habitat destruction, waste heat, etc.)	development of in-orbit/lunar crew habitation and medical facilities development of safe large-scale space construction methods (EVA suit, robotics etc.)
sociopolitical	creation of an international group to manage a space solar power project insure security of satellite and beam (accuracy pointing, remove terrorist threat)	obtainability of desired frequency from ITU	creation of international consensus on the beneficial aspects of space solar power project
manufacturing and assembly	development of advanced assembly techniques (robotics/program/EVA)	extraterrestrial resources processing and transportation techniques development of advanced vibration controlled technique during assembly phase	development of a lunar resource utilization program development of space manufacturing using space power satellite power understanding of the choice of subassembly size (EVA/EVR versus number of launches)
other	achieve business feasibility for program obtain reliable long-term funding sources achieve scientific acceptance public awareness	public acceptance development of effective plan to get a reliable share of the energy market	improvement of the standard of living (overall population)

Table 4.4 Issue Timing

	short term	mid term	far term
space transportation	improvement in operational efficiency and costs for current vehicles preliminary studies for future space transportation vehicles	improvement in operational efficiency and costs for current vehicles detailed studies and engineering tests for future space transportation vehicles	development of improved material for propulsion system development of new propulsion system development of new Earth-to-orbit transportation system (reduced cost, increased rates, mass and volume) improvement in operability and maintainability
spacecraft	structural and electrical interfaces for the Space-to-space antenna and rectenna. development of a deployable phased array structure	beam pointing tracking and accuracy (platform and antenna) computer loads for beam pointing development of large deployable solar arrays and phased array antennas development of more efficient solar cells	attitude and orbit control of large/very large structures improved maintainability of large structures improve large radiator design
power collection conversion and distribution	development of high accuracy phase shifter and solid state power amplifier development of a 2.5 GHz phased array	development of a 35 GHz large phased array and electronic hardware technology development of affordable low power density rectennae	development of more efficient power collection and conversion system improved lifetime of conversion system
environment and life sciences	determination of effects of beam on electronics determination of the risks to astronauts performing experiments determination of effect of beam on astronomical observation	determination of beam on atmosphere and biota (different frequencies) determination of the effects of the beam on communication rectenna effects (construction/habitat destruction, waste heat, etc.) security and maintenance	launch effects on biota and atmosphere danger/effects/possibility of space debris comparison of impact of space solar power with other available energy sources at the time of operation determination of large scale and long-term effects on biota and atmosphere determination of large scale effect on communication and astronomy experiments
sociopolitical	creation of an international organization initiate lobbying of ITU for frequency allocation obtain signatory contributions to space solar power	draft environmental impact statement selection of ground station location (negotiation)	establishment of a commercial organization power allocation and distribution

Table 4.4 Issue Timing continued

manufacturing and assembly	initiate lab studies for in-situ/indigenous resource utilization (IRSU) development of improved assembly techniques using Space Station Freedom and/or Mir experience	engineering scale up of ISRU in space experimental manufacturing (semiconductor, optics, thin-film substrate) initiate mapping of lunar surface development of control and disturbances model of large structure using Space Station Freedom and/or Mir results	development of lunar resource processing (regolith: Al, Si, Fe, O ₂ ; glass, composites) vibration control during assembly understanding of the choice of subassembly sizes (EVA/AVR versus number of launches) ISRU and low orbit space debris utilization
business and other	ensure credibility of ISPO to perform programs promotion of the space solar power concept raise funding for short-term needs raise funding for mid-term needs gather a core of interested scientist and engineers educate people about energy demand, pollution and alternative source of energy	demonstration of space-to-Earth potential benefits assess costing with better accuracy promote space solar power idea, raise funding for far-term needs reassessment of market for the long term development of long-term marketing strategy prove basic scientific feasibility public education about space solar power (technology, effect of microwaves, legal/economic aspects)	marketing of product obtain public acceptance assessment of space solar power cost attain cost effective space solar power

As shown in both tables, significant efforts will be required in making the program commercially and socially acceptable. In particular, significant reduction of launch cost will be needed to initiate the full scale project. Several key technologies will also require to be investigated as well as the environmental impact of space solar power program.

The technology and issue needs summary tables (4.3 and 4.4) serve as a guide in the creation of the technology development plan and assures that the most urgent are developed and demonstrated early. The program builds upon this by developing the next most critical item at each stage.

Each of the projects within the plan represents a goal, a step, to this ultimate goal of an "electric utility". Each of the steps deals with a subset of the requirements and the technologies that are necessary. A step has a significant outcome that supports subsequent steps and is carried out in a timely manner. The relationship between each of these can be portrayed as a series of terraces, the last of which is the operational space solar power program system (Figure 4.5). The representation of the development plan as a terrace is attributed to Peter Glaser. Terracing is "Small projects that have progressive and continuing benefits".

The technology development plan as described earlier consists of five distinct steps or projects, intended to demonstrate technologies and address issues. Each project must serve to support the next project or step in the terraced plan. In addition, long term research and issues must be conducted in parallel in the disciplines of life sciences and sociopolitical in order to support the final goal.

The first step of the development plan is to demonstrate basic space solar power program technologies. The primary technologies to be demonstrated are the collection, conversion, beaming and receiving techniques. A space-to-space demonstration could satisfy the basic demonstrations, while avoiding Earth surface and atmospheric ecological concerns. Additional concerns will be addressed on the determination of the effects of the beam on electronics, the astro/cosmonauts and astronomic observations. This step will also require the establishment of an international organization, and lobbying of ITU for the frequency allocation. Several options exist for this demonstration.

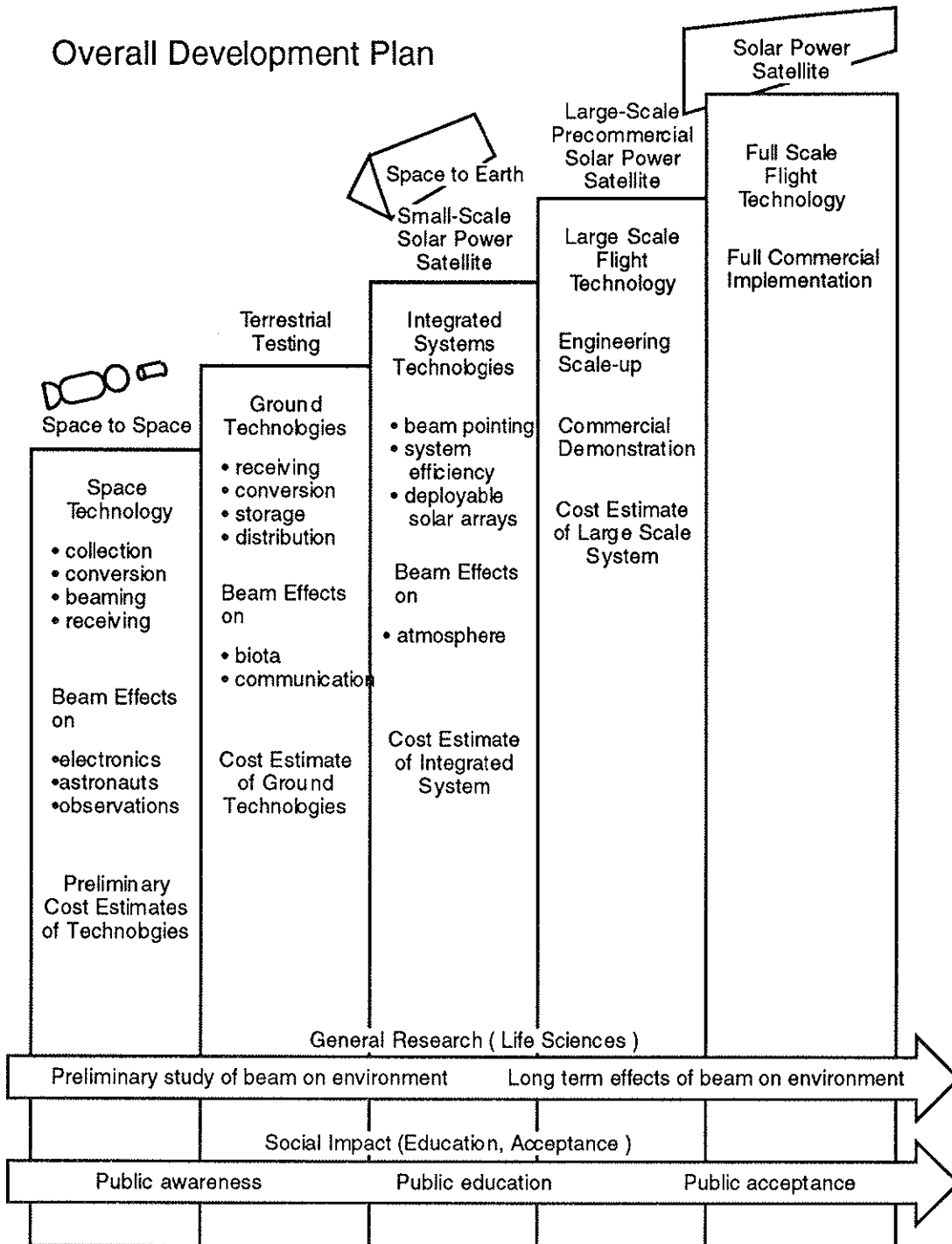

Figure 4.5 Overall Development Plan

Preliminary cost estimates of these technologies for use in a full scale space power satellite can be established based on the demonstrations. Space Station Freedom and Mir could serve as the collection, conversion and beaming site. Progress or other spacecraft could serve as the receiving site. A design example using a Mir-Progress system is described in Chapter 10.

The second step of the technology development plan is to demonstrate the primary ground operations necessary to support a space power satellite. The primary operations include the receiving, conversion, storage and distribution. The effects of beaming on the biota, and communications will be demonstrated. Cost estimates of these technologies for a full scale solar power satellite can be established from these demonstrations.

The third step of the technology development plan is to accomplish a small scale demonstration of a fully operable space-to-Earth solar power satellite. This would serve to demonstrate a fully integrated operational solar power satellite system. Technologies demonstrated would be beam pointing, tracking and accuracy, and computer loads for pointing. Development of large deployable solar arrays, more efficient solar cells, and low power density rectenna will be achieved. The effects of beaming on the atmosphere will be demonstrated. Preliminary cost estimates for an integrated system will be established.

The fourth step of the technology development plan is to accomplish a large-scale demonstration of a fully operable space-to-Earth solar power satellite. Technical feasibility will be accomplished at this step. The primary demonstrations will be of engineering scale-up issues and commercial success. Specific concerns include attitude and orbit control of very large structures, maintainability, and reduced ETO transportation costs. Successful commercial and technical demonstration of the fourth step will be used to finance the final full scale project.

The final step is to achieve a fully operational 1 GW scale solar power satellite. This would merely be a scaled version of step four that besides being technically feasible, satisfies the other original program requirements (Figure 4.1) of business viability, environmental and safety acceptability and social and political acceptability.

Long term efforts in life sciences and social impacts will stretch over the length of the project and continue to progress along with the future enhancements of a solar power satellite. General research should be conducted on the effects of beaming on the atmosphere, the Earth, mankind and other living organisms. Social issues should be introduced in the order of public awareness, public education and public acceptance.

4.5 Non-technical versus Technical Interaction

The main goals of this section are to examine how non-technical issues affect overall project development, and to understand how non-technical factors affect otherwise purely technical tradeoffs. While other chapters of the present report treat non technical issues in far more detail, the intent here is to achieve the "big picture" about how they affect development, and how they get in the way of technical issues.

The importance of these considerations lies in the fact that while technological developments are of primary importance to the viability and success of space solar power, the fundamental problems to be solved have been widely recognized to be of a socio-political and economic nature.

The present study favors the *program*- instead of the *project*-approach. There are abundant reasons to do this: space solar power has suffered from the "megaproject syndrome" since its inception (including critical review of the NASA/DOE study), which has helped little in getting wider support from governments . Also, public opinion is in general not too favorable to "gigantic projects". This has stimulated the presentation of phased programs. For example, space power satellite inventor P. Glaser has recently proposed a "terraced" approach where self-sufficient projects fulfill stages of development towards a final objective of large-scale solar power, which is not fixed to a pre-specified future date[Glaser,1991a]. The comparison is found with the U.S. Interstate Highway System (total cost of more than \$150 billion to date) and others which may well be unwarranted, as a highway system is by its nature an incremental development and can immediately begin to be fully used to serve local needs as soon as new routes are finished (in fact, it provided tangible benefits after 1 year). The question that naturally arises then is : would the U.S. government and public have supported the program had they had to wait 40 years to use the highways[Leonard,1991a]. The economical viewpoint is that it is at least questionable to make detailed economic plans on life cycles as long as 30+ years when "life cycle cost" is brought up as the consideration of choice for tradeoffs in the face of highly uncertain usage rates, among other major uncertainties. The positive side of these considerations is that they help clarify the major critical challenge for the phased approach: to envisage meaningful independent goals for each of the phases, in such a way that they contribute effectively to the final goal (it has to be recognized that the contribution of each stage may be sub-optimal in terms of time, when compared to the *megaproject* approach). A closer consideration of the issues to be found below suggests that for large-scale space solar power the *program* approach is also partly a *scenario* approach: several major developments of wide implication and scope have to occur to render the program viable, that are not in full control of even the most powerful decision-making bodies of today. In this setting, the program can hardly be conceived in any usual fashion regarding management issues. This is the most far-reaching instance in which the non-technical

context of the program affects a hypothetical "well-planned", technically and economically driven development.

Back to basics. If the *energy* question was at the origin of the invention of the solar power satellite concept, and if the largest past funding for studies (NASA/DOE study) began and ended exactly when the energy crisis of the 70's did, can governments' decided support for large-scale space power be expected before a future energy crisis begins to show its first clear symptoms? It is difficult to make forecasts in this matter, and there is not much that can be done about it anyway. Wise as it is to act in advance before a problem comes, past experience shows that political thinking is tied (at least largely in democratic regimes) to not-too-distant time horizons. But there is some constructive thinking to do about energy problems: how to enforce the so-called "real cost of energy", an environmentally beneficial step that would help solar energy to be competitive in the energy market. Solar power advocacy is then aligned with the environmental concerns in favor of a renewable, clean energy source that also avoids further global warming. Additionally, an encouraging idea is found in the literature: space solar power could be used as foreign aid, while the space infrastructure gets built in the process [Leonard,1991b]. It must be stressed that addressing the energy problem is *the* side of the Space Solar Power Program capable of getting the general public interested, as it does not rely on space "justification". (Compare with the claim that the major proportion of the so-called economic "spin-offs" of space projects are other space-related activities [Cohendet,1992]).

Frequency allocation and *geostationary slot allocation* issues show how fundamental technical system drivers (frequency of power transmission, choice of orbit) are greatly affected by non-technical considerations, mainly the *de facto* situation in past allocations. Interference problems also add technical constraints. The importance of this issue cannot be underestimated, as has been widely recognized by space solar power proponents. A constructive view calls for early action in the appropriate forums and that the necessary lead times involved be investigated.

Liability issues appear in various areas (among them frequency interference, health hazards, space debris generation, effect on other aircraft) and are a major driver influencing various technical tradeoffs at all system and subsystem levels. A matter which is not sufficiently explored in the literature, to our knowledge, is the cost of insurance for EVA activities. It is clear that the large construction times needed will call for EVA time in an unprecedented scale, and an increased possibility of accidents. A realistic estimate of risks after more space construction experience is available, and an investigation on how to cope with them will in the near future be called for. The bottom line is that a new perspective from governments regarding space activities is needed, shifting from one of invested national pride to an industrial perception of space and thus avoiding the paralyzing effects of extreme risk aversion.

Construction and Transportation in space are major cost drivers. There is uncertainty about the possibility of bringing them down, and technology challenges ahead. Many large-scale Space Solar Power Program development scenarios call for space infrastructure to be already in place, so the program is here again dependent on the fate of other efforts of size and scope comparable to its own, which clearly encompasses major non-technical issues.

Use of Non-Terrestrial Materials (NTM) has been frequently regarded as the better chance for economically sensible large-scale space solar power. This introduces uncertainty and a significant dependence in the Space Solar Power Program, as it makes it rely on the progress of Moon exploration (in other words, the whole infrastructure needed is not expected to be sustained by the program bill). Some authors readily recognize this fact and suggest that all space solar power supporters should be equally Space Exploration Initiative (SEI) supporters, and developers of a joint space technology [Poher,1991]. The point is again that in its fullest scope, SEI is an endeavor potentially as considerable as the Space Solar Power Program. In turn, the progress of SEI/NTM usage depends on some technologies still to be developed and on societal and political issues underlying its funding needs (e.g. existing and future Moon treaties could restrict the use of large amounts of lunar material). Also, experience shows that funding and schedule for a space project is very sensitive to other space projects' incidents or failures. Thus, Space Solar Power Program evolution and future will ultimately be linked to worldwide, very general trends in space development.

For historic reasons, key players and decision-makers in the space community normally hold a cost philosophy which does not favor space economies of scale. A change in the *aerospace culture* is needed, shifting from extreme risk aversion and the unwillingness to invest up front significant amounts to a low-cost life-cycle, "industrial" and entrepreneurial perspective [Simon, 1992].

Public acceptance is another cornerstone of a successful space solar power program. It has been noted that the issues of environmental effects and public reaction should be explored much before space solar power is made known to the general public, and that its proponents should get involved in educating people, much as this is seen as difficult and costly by the technical community. Fears of military use, vulnerability and biological effects of solar power satellites by the public can jeopardize the success of the program. For this reason, a large lead-time and a substantial investment in environmental studies and public education is to be expected [Lehman and Canough, 1991]. Additionally, tangible successes of the program each 2-4 years have been suggested to be crucial to a sustained public interest [Leonard, 1991a].

In summary, Space Solar Power Program may be understood as a scenario-based program, and its success be linked to general future trends in space development, even if its final goal addresses the fundamental (and Earthly) future energy needs of our planet. Non-technical regulatory and public acceptance issues will dominate its development and greatly influence technical choices.

4.6 Overall Schedule

The overall schedule for the Solar Space Power Program is shown in Figure 4.6. The program is scheduled to start in September 1992. In principle the schedule is separated into four major tasklines :

- Business and Management Aspects (Start: 1992)
- Political and Legal Aspects (Start: 1994)
- Environmental and Safety Aspects (Start: 1994)
- Technological Aspects (Start: 1992)

In Figure 4.7 the bars represent the several subprograms of the Solar Space Power Program. The schedules for these subprograms can be found in the relating chapters of this report. The rounded boxes represent major milestones of the program. The subprograms and milestones are basically arranged in a timeline starting at the left in 1992 until the first Space Power Station is operational in 2039 at the right. The numbers at the upper left of the boxes indicate the starting dates, the numbers at the upper right the finish dates and those at the lower right the duration of the several subprograms. Additional information is contained in Appendix G.

The Technology Aspects taskline is separated again into four tasklines:

- Spacecraft Development
- Transportation Systems Development
- Resources, Construction and Manufacturing Development
- Power Collection, Conversion, Transmission and Reception Development

The most important taskline is the Spacecraft Development taskline. It lists the several demonstration programs that are introduced within this report and their launching dates :

- Demo 1 (Space to space demo; Launch 1996)
- Demo 2 (Space to Earth demo; Launch 2005)
- Demo 3 (1 MW space to Earth; Launch 2012)
- Demo 4 (100 MW space to Earth; First launch 2024)
- First operational 5 GW Space Power Station (First Launch 2036)

The whole overall schedule is basically coordinated around this timeline for the demonstrations. To keep this chart readable not all of the connections between the several tasklines could be illustrated. The schedules for the several subprograms are referring to the demonstration programs timeline and this chart.

This schedule tries to describe a way to realize a space power satellites within a reasonable amount of time. It is orienting on the terrace concept introduced by P. Glaser as shown in Figure 4.5. The near-term programs of the schedule are described in much more detail in other chapters. A major difficulty in designing an overall schedule for such a huge project is to estimate the duration of the far-term programs. It is unpredictable whether major new technologies that may be applied to this program are developed in the coming decades or whether any "showstopper" is found while developing this program. This schedule is basically assuming that especially the political and financial problems that such a program is facing can be solved. Also, it is assumed that a reasonable technological progress

takes place in the following decades and that crucial technologies especially cheaper launch vehicles will be available. Anyway, one has to be well aware that this schedule can only be matched if no major difficulties occur. It is a *best case scenario*.

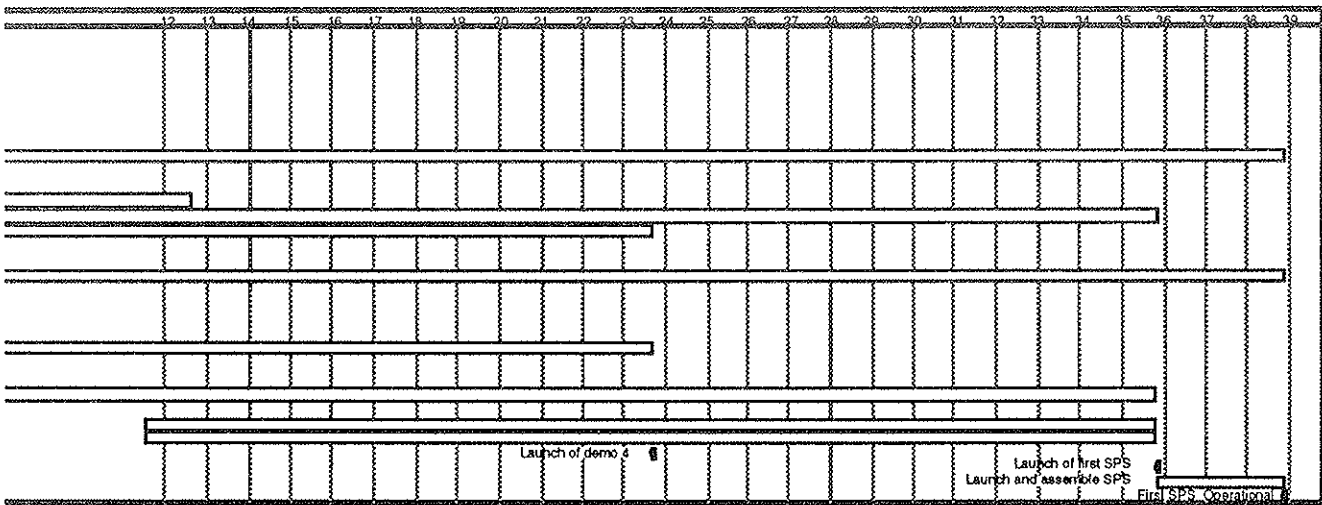
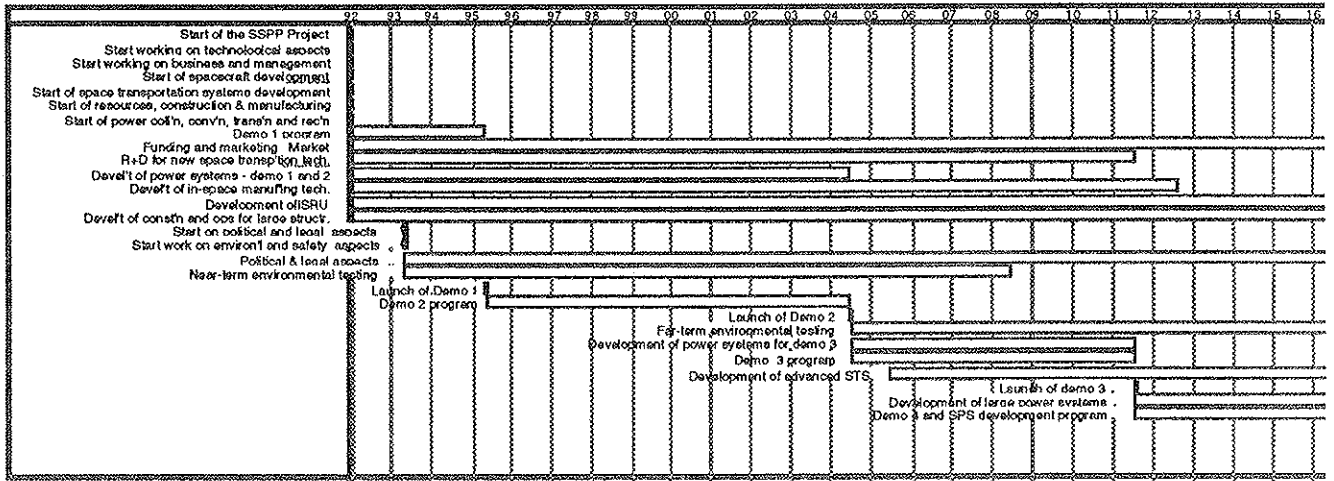

Figure 4.7 Timeline for Overall Space Solar Power Program

References

- Hamakawa, 1981, A guide of solar photovoltaics (Taiyoukouhatuden Nyumon), Hamakawa Y., publisher OHM, in Japanese, June, 1981
- Fordyce, 1992, Lecture on Thermal to Electric Space Power Systems, Fordyce J., NASA Lewis Research Center, OH, USA, for International Space University, Kitakyushu, Japan, July, 1992
- Bailey & Landis, 1990, Photovoltaic Superiority for Space Station Freedom Power in the 21st Century, Bailey S.G., Landis G.A., Conference Record of the IEEE Photovoltaic Specialists Conference, Vol. 2 (IEEE, NY), Kissimee, FL, USA, pp. 1356-1361, May, 1990
- Glaser P., "The Solar Power Satellites Option Reexamined", 2nd International Symposium SPS 91 "Power from Space", Paris / Gif-sur-Yvette, August 1991, pp 59-64.
- Leonard, R., "A different race: Global Rural Electrification, Market Niches, the Third World as a starting place for SPS", 2nd International Symposium SPS 91 "Power from Space", Paris / Gif-sur-Yvette, August 1991, pp 109-116.
- Leonard, R., "Economic impact of using lunar resources to build SPS systems", 2nd International Symposium SPS 91 "Power from Space", Paris / Gif-sur-Yvette, August 1991, pp 154-163.
- Cohendet, P., from Core Lectures of Business & Management Dept., International Space University, '92 Summer Session, Kitakyushu, Japan, July 1992
- Poher, C., "SPS technology development strategy in the context of the Space Exploration Initiative", 2nd International Symposium SPS 91 "Power from Space", Paris / Gif-sur-Yvette, August 1991.
- Simon, C., "Management of space systems to reduce costs", Presentation at International Space University, Kitakyushu, Japan, August 1992
- Lehman, L. and Canough, G., "The environmental impact of SPS: a social view", 2nd International Symposium SPS 91 "Power from Space", Paris / Gif-sur-Yvette, August 1991, pp 195-200.
-

5 Organizational Plan

While technological and economic feasibility studies are key factors in determining whether a scientific and/or technological project will succeed, certainly an understanding of the international, organizational, management, legal, political, and external factors is critical to a program's success or failure. This chapter address such issues as they relate to a space solar satellite system and to the International Space Power Organization (ISPO) in particular.

5.1 International Cooperation

The end of the Cold War had varying effects on space programs in many nations. Both the United States and the former Soviet Union, which had been justifying their large projects in space by emphasizing the threat posed by the other, are now experiencing budgetary problems to the extent that space programs need to be justified based on other benefits. The situation in other spacefaring nations, in terms of political support and financial resources is no better than that of these two major spacefaring nations. Budgets for space are still limited, and no nation at this moment seems to have clear objectives in space.

The world is progressing toward an acceptance of greater cooperation for large-scale technical and scientific programs. To expand or even to maintain the sphere of space activities, international cooperation is considered necessary by many nations. More importantly, international cooperation is considered a requirement in some areas. The recent discoveries on the effects of CO₂ emission and the depletion of ozone layers has raised the level of public concern for the protection of the Earth's environment. Such protection requires cooperation among all nations of the world. Opportunities for cooperation are increasing as new opportunities exist for cooperation between the Western and the Eastern blocs.

In terms of international cooperation, a space solar power program can be said to enjoy more favorable circumstances than previous international space efforts, as we will demonstrate. Nonetheless, there are still persistent obstacles. The objectives of this section are to examine the effects of current changes in the world order and to analyze the political implications on the space solar power program.

This part is divided into three sections. The first section examines new factors in international space cooperation. How the current changes in the world order affected international cooperation is the subject of concern. Then some of the new objectives in space are discussed in the next section. In this section, not only positive factors for cooperation are presented but also negative factors which can prevent successful international cooperative projects. Finally, in the third section, the political implications of a cooperative space solar power program are discussed.

5.1.1 New Factors in International Space Cooperation

Space policies of major spacefaring nations now seem to be at a turning point. During the last few years, there have been some radical changes and some visible consequences of the gradually accumulating small changes in the international political regime. There are at least three major changes affecting space cooperation.

One is the decline of U.S. economic power and eroding U.S. technological leadership. Recently the United States is a debtor country facing "twin-deficits," a trade deficit and a federal budget deficit. It has become difficult to justify U.S. leadership from an economic point of view. Regarding technological leadership, the United States is suffering a loss of industrial competitiveness in some high-technology industries, especially to Japan. There is much concern for the loss of technological leadership, and for the necessity of limiting technology transfer to other nations.

Another change concerns the enhanced opportunity for cooperation with Russia. Due to chaotic economic situations, higher priority in Russia has been placed on accepting financial aid rather than maintaining military power. The financial problems are, indeed, so serious that even the military is struggling to secure a decent budget for itself. If an international cooperative project included some kind of financial contribution to the Russian society, the military, which has up to now been controlling the entire society, would likely be willing to participate, even if such participation required them to conduct that program from a civilian, as opposed to military, context.

Finally, the integration of European nations effects space cooperation. What is new here is the integration of Western and Eastern European nations. Due to their geographical location, Western European nations are more serious than any other nations in supporting Eastern European countries. Financial crisis in the latter will directly effect the social and economic order of the former. An example of this would be the movement of unemployed Eastern Bloc laborers into Western Europe, affecting their unemployment rate. The financial burden for Western European nations to support Eastern Europe is enormous.

5.1.2 Objectives in Space Under the New Regime

When facing such severe budgetary constraints, nations make decisions about whether to start a new program in space based on very specific objectives. In this section, three prevailing objectives under the new regime are discussed.

One is the demonstration of national pride through development of advanced technology. Since World War II, national power has been measured by the progress of technology development. Even as the relative importance of military technology has decreased, the development of advanced technology is still considered crucial for industrial competitiveness, which directly impacts a nation's economic power.

Secondly, the commercialization of space is a clear motivation for beginning new space programs within any of the large spacefaring nations. The development of commercially viable technologies then becomes crucial. Common strategies through international cooperative efforts in space have been successful in basic and applied research. This reduces each nation's total share of the total cost of doing such research and allows scientific information to be more widely disseminated. Then when a program reaches the commercial stage, each nation can pursue its own interests. It should be noted, however, that when commercial interests are clearly envisioned in the near-term, it often becomes difficult to carry out effective and meaningful cooperative projects.

The third objective concerns the benefits for mankind. Due to increasing concerns for the global environment, the necessity to save the Earth through the application of space technologies is strongly sensed by some nations. Partially due to intense discussions on causes of green-house effects and current status of depletion of ozone layers, space programs designed to help save the global environment seem to win public support. Those programs can not be undertaken by only one nation. Therefore international cooperation becomes imperative.

5.1.3 International Political Implications of the Space Solar Power Program

The space solar power program will be carried out through international cooperative efforts. Under the new international political regime, the space solar power program will be affected by all the changes previously discussed. If the space solar power program turns out to be successful, it will be a model for future international cooperative efforts. However, before considering the chances of success, one should analyze whether the space solar power program is attractive enough for potential participating nations from the international political aspect.

It can be said that the space solar power program is a unique international cooperative project which will meet those three objectives discussed in the previous part. First of all, the space solar power program provides good opportunities to demonstrate a nation's technological potential. New technologies such as power beaming technology will be developed through the program, increasing the technological level of participating nations. Moreover, some of the advanced technologies of the space solar power program will be visible from the Earth. Particularly in the long-term phase, not only its ground facilities but also technologies used in outer space will be visible on the ground due to the magnitude of the program.

Secondly, there is commercial potential in this program. It is highly unlikely that the total global energy demand will decline. Considering the limited supply of petroleum, on which a large portion of present human activities depends, nations should seek an unlimited energy source. Solar power is a good solution. If the cost of production decreases significantly in the long-term phase, as the technological development progresses, participants in this program can expect a substantial amount of commercial profit.

Finally, this program would assist in saving the Earth to some extent. The space solar power program provides an alternative energy source, thus, preventing the continuation of the serious energy crisis

due to depletion of fossil fuel and the negative effects of emission of CO₂. Even if most of the nations in the world can agree on taking some effective measures to prevent emissions of burning fossil fuels, there must be alternatives to replace petroleum use. Initiation of the space solar power program can provide good supporting ground to lead the nations toward meaningful and necessary agreements to protect the global environment. Indeed, the space solar power program can be an international cooperative test case to prove whether the nations can get together to save the Earth.

What should be noted here is that the space solar power program is politically complicated. This is a program in which objectives by participating nations may well contradict each other. While commercial interests in this program will be pursued by each individual nation, benefits to the global society as a whole must be achieved. By providing an alternative energy source, which has been a long-term interest and need of mankind, nations can unite to benefit the many. The ISPO structure is crucial to achieve each of these objectives at a satisfactory level. In the following section, the most suitable organizational structure is discussed in detail.

5.2 Organizational Structure

The ISPO has been created to be a flexible structure which can evolve as the space solar power program progresses through its three-phased development process:

- Phase I: \$80 million space to space feasibility demonstration
- Phase II: \$800 million space to ground feasibility demonstration
- Phase III: Development of a large-scale commercial system from space to terrestrial power grids.

The philosophy of the organization will be to focus on technical and commercial objectives rather than political goals. Therefore, commercial management techniques will be utilized, and procurement contracts will be awarded principally through an open bidding process as opposed to a system of "Juste Retour", where contracts are awarded to organization members based on their overall contribution. Additionally, staffing decisions will be made on a merit basis with secondary attention given to equitable geographical distribution. A strict application of commercial principles will be mitigated somewhat by a policy of encouraging broad international inclusion in the ISPO.

Signatories

The organization will be international in scope. It is important at the early formative stages of the organization to include all the major players who are interested in space solar power. These include interested governments, the various space agencies, the utility companies, the scientific community, the manufacturers, the financial institutions and the media. A method well-suited to regroup the players is by means of a founding conference. The founding conference would be responsible to introduce all the members involved, to promote and educate the members on the goals of the Space Solar Power Program and to provide the short- and long-term plans for the project. The conference would conclude with a formal ceremony of the Signatories.

The conference will need initial support, both financial and in kind. This support could come in part from the aforementioned players and from institutions such as the Space Studies Institute whose goal is to promote the peaceful development of space.

Governmental and private entities who contribute a minimum amount of financial or in-kind support will become Signatories of the ISPO. Such a minimum amount will be set forth in the ISPO Charter (hereafter the Charter). All Signatories are members of the Assembly of Signatories. Each Signatory is given an equal vote in the Assembly of Signatories which will meet at least once per year. The function of the Assembly of Signatories is analogous to the role of a stockholder's meeting in a private corporation. They are responsible for setting overall policy and making major strategic decisions. Their role also includes overseeing the Board of Governors, (hereafter, the Board) who report directly to them.

Board of Governors

Each member of the Board is appointed by a Signatory. Each Signatory has the power to appoint Members of the Board in proportion to the Signatory's contribution. The Board functions like the Board of Directors of a private corporation. They are responsible for implementing the policy of the Assembly of Signatories and overseeing management decisions. In order to accomplish the latter

duty, the Board shall retain both an independent auditor and a Scientific and Technical Advisory Panel. Formal Board meetings will be held on a regular basis, as defined in the Charter. Special Meetings of the Board can also be called by Board Members after sufficient notice is given as defined in the Charter. The Board has the authority to make final determinations of the retention of income. All non-retained income shall be distributed in proportion to representation on the Board. After Phase III becomes operational, Signatories will have the option of accepting their share of power (in proportion to their representation on the Board) generated in lieu of the share of non-retained income from the Space Solar Power Program Organization's sale of such power. The Board is also responsible for setting a management plan and appointing the Executive Body.

International Inclusion

In order to insure inclusive national representation in the Space Solar Power Program Organization, a mechanism will be in place to assist developing countries who otherwise would have difficulty participating. Both national and international bodies support developing countries with project-targeted financial assistance. Often, constraints are imposed on the funds which require the receiving nation to purchase goods from the donating body. As a result, these constraints may reduce the potential growth of the developing countries. As an alternative to this scheme, a donor could provide funds on behalf of a developing country to make such recipient country a Signatory of the Space Solar Power Program Organization. The Space Solar Power Program Organization would then make a good faith effort to allocate to the developing country a contract or subcontract roughly equivalent to the amount donated. In this way the donor would both be able to support the creation of technological expertise in developing countries and allow the inclusion of developing nations in the progressive development of the Space Solar Power Program Organization.

To qualify, a country must make an application documenting its fulfillment of United Nations criteria for developing country status. It must further demonstrate areas of technology in which it could make contributions. These applications would then be reviewed by the Scientific and Technical Advisory Panel established by the Board of Governors.

The Executive Body

The Executive Body is responsible for carrying out the day-to-day operations of the organization in accordance with the decisions of the Board. Managers are assigned to each segment that requires the retention of subcontractors.

5.2.2 Management Structure

This section describes the management structure which will be implemented in the Space Solar Power Program.

The assumption was made that the management structure for the different phases of the program should not differ too much but should rather evolve from the Space to Space Beaming demonstrator (\$80M, also refer to section 10.2) project to the Space to Earth Beaming demonstrator (\$800M, also refer to section 10.3) project and further on to the commercial power beaming program. The obvious advantage is that the organization of the demonstrator and its lessons learned will then not be discarded of, but will serve as the basis for the commercial Space Solar Power Program. Therefore a management structure was chosen which could easily grow.

Although the management structure has to be quite large, it should be noted that effort shall be taken with the implementation of the structure, that the bureaucracy will be limited, such that the organization can function effectively and efficiently. This should also ensure that during the Space Solar Power Program, necessary technical or other changes can be implemented in a timely manner.

In the following, the word program is used for all the different program phases, and only where differences are to be seen between the phases, will this be addressed. A detailed description is presented of the responsibilities of the functions in the organization chart of Figure 5.1.

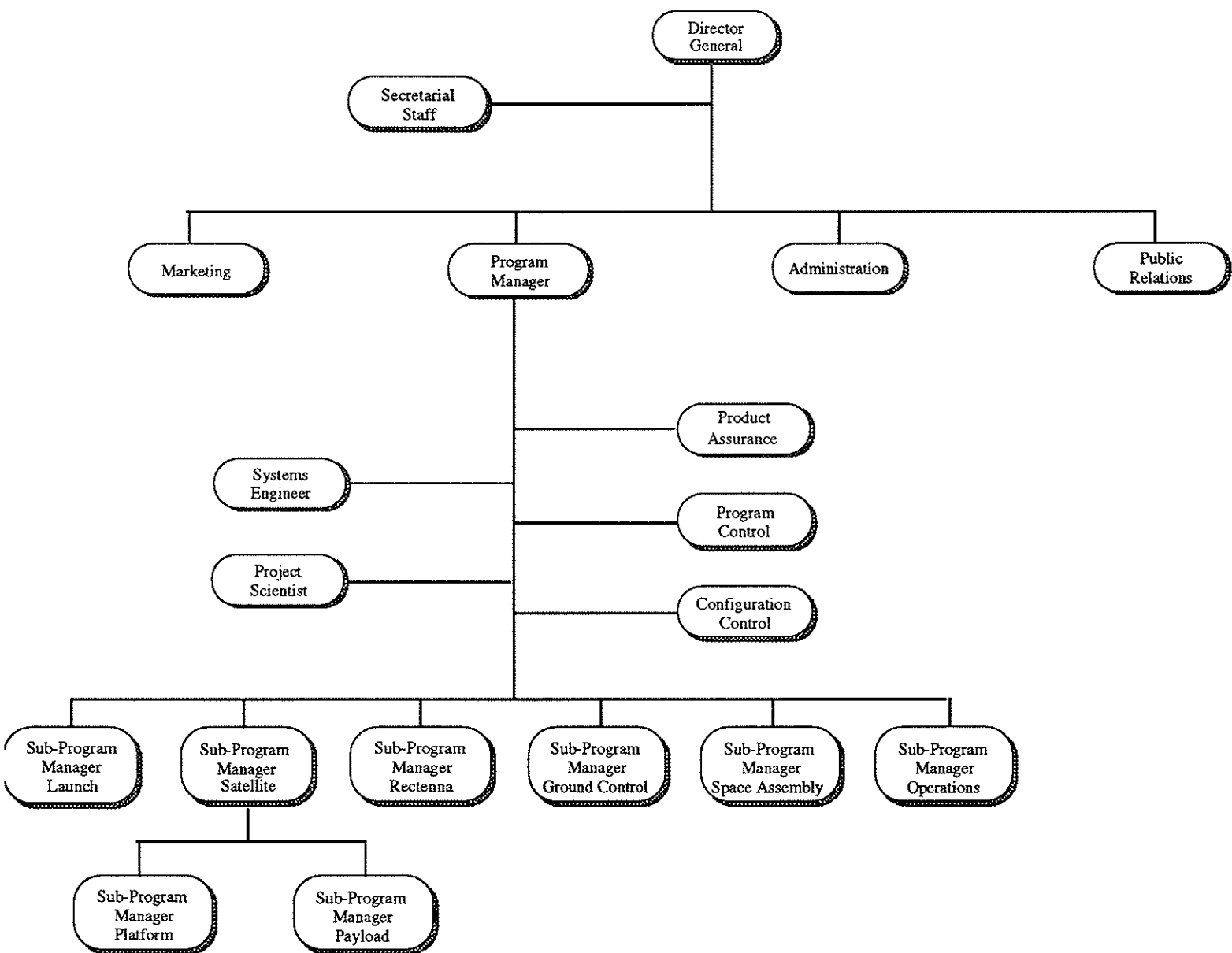

Figure 5.1: Organization Chart of the Management Structure for the Space Solar Power Program

Director General: The Director General (DG) is the person responsible for managing the organization. The DG's task is not only to guide the organization towards meeting its objectives, but also to ensure that this happens in the most efficient way. The DG has the important role of being the interface between the investors and the operational level. The DG will have to report to the Board of Governors on a regular basis. This report shall include, amongst others, the current technical situation and the most current market analysis. The input on the operational level should be limited to observing whether technical decisions are in accordance with the Board's set requirements. The Director General, with the approval of the Board of Governors, has to plan the development of the organization from the first demonstrator program towards the commercial program.

Secretarial Staff: The secretarial staff has the obvious task of supplying the organization with the necessary secretarial support.

Administration: The primary objective of this directorate is to provide the necessary administrative support to the organization. This includes all the matters connected with the contracts, finance/accounting, personnel and legal affairs. The responsibilities of these departments can be described as:

- contracts: coordinate the preparation and issue the Requests for Proposal; negotiate and award the contracts; perform all the administration connected with the contracts
- finance/accounting: evaluate, prepare and monitor the yearly budget; oversee the prime- and sub-contractor's payments; perform the accounting relating to the received contribution (in case of the demonstrator) and the received revenues (in case of the commercial Space Solar Power Program)
- personnel: coordinate personnel recruitment and training; manage personnel benefits such as, e.g., medical insurance, pension funds
- legal affairs: ensure adherence to international treaties and agreements; give support to the contracts department; prepare the legal documents; provide legal advice where necessary and act as counsel in case of disputes.

Marketing: The marketing manager (MM) has the responsibility to search for and develop new markets all over the world. The MM will provide market analyses in regular intervals to the Director General.

Public Relations: The Public Relations directorate (PR) has the responsibility to interface closely with the different governmental agencies, companies and other organizations involved with the Space Solar Power Program. It is the responsibility of PR to inform the general public about the Space Solar Power Program and its evolution by contacting the appropriate media. Another field of responsibility includes education campaign to obtain and maintain public and political support.

Program Manager: The program manager (PM) is responsible for the technical implementation of the program. This manager is appointed by the Board of Directors and will be supported by a staff consisting of the sub program managers, the product assurance manager, the system engineer, the configuration control manager and the program control manager. The PM will report to the Director General. In turn, the staff reports to the PM. The PM has to ensure that the political decisions of the Board of Governors are implemented technically. This will be achieved by coordinating the product assurance, the system engineering, the configuration control, the program control and the sub-program manager's input to the program.

Product Assurance: The Product Assurance Manager (PAM) is responsible for the total quality of the program. The PAM has to assure that the reliability of all program elements meets the requirements, and that the quality is according to the international (and agreed upon) quality standard system. Therefore the PAM will be involved during all phases of the program and has a strong interaction with all the other departments and also with the product assurance departments of the subcontractors. The PAM's responsibility includes the evaluation and qualification of new technologies and procedures, as well as the qualification and acceptance tests for all program elements. Also the (final) quality control will be the responsibility of the PAM. Hierarchically, the PAM is located on the same level as the system engineer, the configuration control manager and the program control manager; working 'under' the Program Manager, but 'above' the sub program managers.

Systems Engineer: The Systems Engineer (SE) is responsible for achieving the most effective technical means to achieve the desired performance of the program. For this, the SE has to define the top-level requirements and the interfaces between the various program elements. The evaluation of

the total design is another very important responsibility of the SE. The SE will coordinate and facilitate any necessary exchange of information (such as concerning the interfaces) between the sub-program managers.

Project Scientist: There will be a team of Project Scientists (PS) for every demonstrator. The PS will be responsible for the science to be performed. The PS are selected by a selection committee which was in turn selected by the Board of Governors for their outstanding scientific accomplishments in their field of research. The PS has to set the scientific objectives of the project and the goals to be achieved. As the main research will be performed in the fields connected with the rectenna and the platform, dedicated Principal Investigators (PI) will be on these fields (see also Figure 5.2). The PS coordinates the research of the PIs.

Configuration Control: The Configuration Control Manager (CCM) is responsible for the identification, accounting and control of the engineering baseline. The baseline, which consists of a set of drawings, specifications and procedures, has to be maintained, and any changes to it have to be managed by the CCM. The CCM has the responsibility to check that the hardware built is according to the baseline plus any changes (also non-conformance).

Program Control: The Program Control Manager (PCM) is responsible for the schedule of the main program. The PCM has to identify and control possible delays and their effect on the main schedule. For this a strong interaction with the project controllers of the various program levels is required.

Sub-Program Manager: Each of the sub-program managers (SPM) is responsible for a specific program element. There will be a SPM for each of the following aspects:

- space transportation / launcher
- rectenna
- ground control (mission control for launches, operation of the platform)
- space assembly (especially for the commercial program: here large solar arrays are necessary to generate the required power, which cannot be deployable anymore, but which will have to be assembled either by robots or humans)
- operations (change of payload configuration for changing client's needs)
- satellite

and the work of the satellite SPM is the coordination of two other SPMs, whose responsibility are the:

- platform (which, amongst others, includes the satellite structure and attitude orbit control system)
- payload (consisting of the solar array, antenna and transmitter)

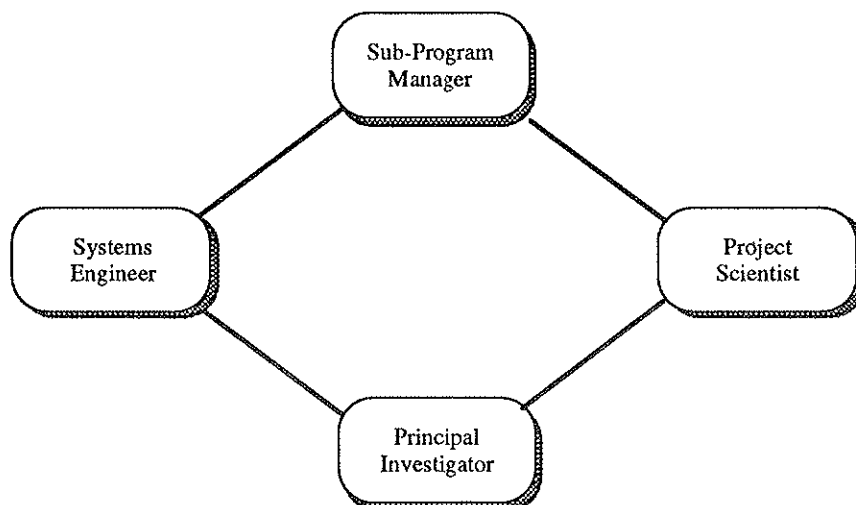

Figure 5.2: Responsibilities of the Scientific Branch

Each SPM is responsible for coordinating the work of the various sub-contractors in the SPM's field of work. Concerning the interfaces with other program elements, the SPMs report to the System Engineer, who will coordinate any necessary exchange of information between SPMs. The SPM shall closely work together with the Product Assurance department.

Principal Investigator: A Principal Investigator (PI) is dedicated to one specific experiment in the area of rectenna or payload research. The PI reports and is responsible to both the project scientist and the sub-program manager. The parameters will be given to the PI by the sub-program manager.

The Space to Space Beaming Demonstrator (\$80M) Management

Specifically about this project, please note that:

The objective of this design example is to beam power by microwaves to a simulated micro gravity laboratory. More specifically, the objective is to beam power from the Russian MIR space station to a PROGRESS transport spacecraft over a distance of about 80m (also refer to section 10.2).

The elements relative to the management structure of the Space to Space beaming design (\$80M) example are as presented below (also refer to Figure 5.3):

The Director General (DG) with the accord of the Board of Governors, will have to plan the development of its organization to permit the management and realization of the Space to Earth project (\$800M).

Public Relations will play a specific role in this project by conducting different lobbying campaigns to insure funding for the activities and to obtain public and political support.

Finally, the Systems Engineering (SE) function will be a task team of Engineers and scientists responsible for performing all classical SE functions such as overall system definition and configuration control. It will create requirements documents that define both functional and interface requirements imposed by the system on each element.

Members of the SE will be responsible for monitoring the development work of the various sub-contractors. They will have to assure that all the elements of the sub-programs meet the requirements specified. They will be responsible for the quality of the products developed and will control the configuration. They will have to perform the necessary tests to verify the quality and functionality of the different elements of the system and to test the complete system. The major systems (and sub-systems associated) to be developed are the antenna, the transmitter, the rectenna, the receiver, the interfaces and other systems. The SE members will be responsible for preparing the system for transport to the launching site and providing the necessary technical support of the launch. The SE will finally have to test and analyze the data obtained following the experiment. System analysis and evaluation is required.

The Space to Earth Beaming Demonstrator (\$800M) Management

The Space to Earth beaming design example specified in section 10.4.6 will demonstrate the feasibility of space to Earth power beaming. Upon successful completion of this demonstrator, a Space Solar Power Program will eventually evolve.

It should be clear that all of the above mentioned responsibilities of the functions/ departments are heavily dependent on the size of the program. In case of the Space to Earth beaming demonstrator, the work will be divided according to the organization chart of Figure 5.1, however, the size of the different departments will be much smaller than it will eventually be for the commercial program.

The function of project scientist is of utmost importance during the demonstrator projects, because the scientific data from the demonstrator will serve as a basis for the commercial program.

As is also described in the previous section, the public relations should already be fully functional at the time of the demonstrator.

It is, for example, not necessary to have a marketing directorate in the beginning of the demonstrator project, whose objective is mostly to serve as a technical and commercial viability demonstration, instead of being a really commercial program. The marketing directorate does of course become more important as time passes and should be fully operational when the commercial program starts.

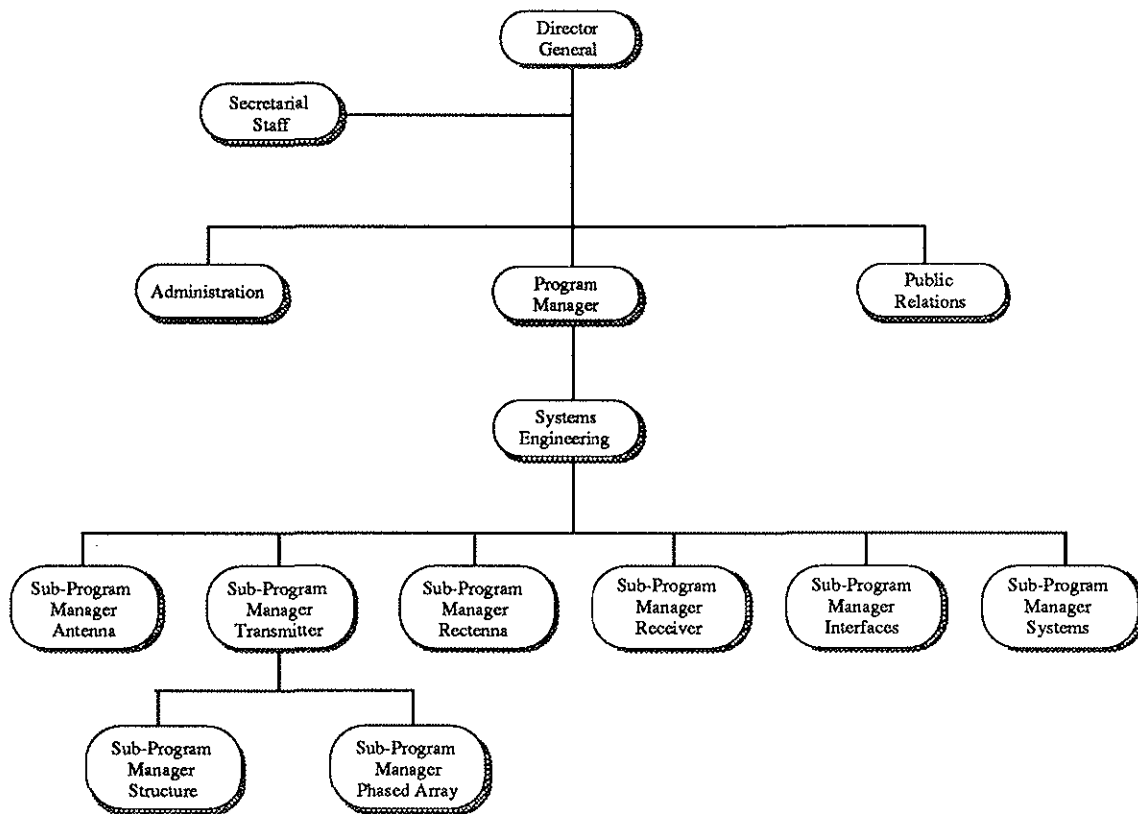

Figure 5.3: The Management Structure for the Space to Space Beaming Demonstrator (\$80M)

5.3 Legal Framework

A space solar power program, with the development and construction of a solar power satellite system would necessarily involve a number of challenges: technological, financial, institutional and legal, among others. The space solar power program has relevance to international law, especially to space law, because the utilization of solar power satellites implies the use of a variety of space resources. In effect, to become operational, solar power satellites will require power from a celestial body, the Sun, the utilization of the geostationary orbit, lower Earth orbits, or Lagrangian points; and the radio frequency spectrum. This is true both for communications purposes and for the transmission of energy to Earth by microwave or laser beams. Placed near the Moon, solar power satellites could also serve as a power station providing energy for a lunar base or for return to Earth. It may be very useful to take lunar materials or other non-terrestrial resources for the manufacture of the satellites, which would have legal implications. Other considerations include protection against the possibility that microwave or laser beams and receiving antenna, built as part of solar power satellites, could be used as strategic weapons, and the generation of some unconventional environmental and health hazards which at present are poorly understood.

The legal implications of the circumstances quoted above are wide ranging. Thus, the presence of jurists is required in the space solar power program. Before the exploitation of solar energy in space can commence, the legal status of activities involving solar power satellites must be clearly established. There is no doubt that the implementation of a space solar power program will be a challenge to the abstract and generic principles prescribed in the existing outer space treaties and other agreements and principles of international law. To be operational, a space solar power program will need legal solutions to very specific problems. Hence, it will facilitate new reflections and developments in general international space law.

5.3.1 Some Legal Aspects Of Outer Space

In this paragraph we are going to cope with various specific issues of outer space law which are relevant to a space solar power program. But, first of all, we have to determine that outer space law is applicable to activities carried on by solar power satellites.

Although, there is not a concrete agreement concerning the definition and delimitation of outer space, it is generally accepted world-wide that the geostationary orbit belongs to outer space. This is evidenced in the practice of States as well as the international space organizations such as Intelsat, Inmarsat, Intersputnik, Eutelsat, Arabsat, and others. It follows that outer space law applies to the use of solar power satellites in geostationary orbit. Therefore, the Outer Space Treaty of 1967 (OST), the Astronaut Agreement of 1969; Liability Convention of 1972; Registration Convention of 1975; Moon Agreement of 1979; and any other rule of international outer space law, are applicable to the activities surrounding the utilization of solar power satellites. Hence, the geostationary orbit (and in our opinion also the lower Earth orbits), the Moon, etc., are affected by the principle of freedom of use, non appropriation, and restriction of use for peaceful purposes, as articulated in the above treaties.

The principle of freedom on use of outer space, including the Moon and other celestial bodies (art. I of OST) is a customary norm of public international law that implies the right of free access, free exploration and free utilization. These rights of States are not absolute but rather relative and limited. The same article I, par.2 of OST establishes that outer space "shall be free for exploration and use by all states without discrimination of any kind, on a basis of equality and in accordance with international law". In reality, only a few States, those that have enough financial and technological capacity, can exercise such freedom. Article I, par.1 of OST, imposes other limitations: the exploration and use of outer space "shall be carried out for the benefit and in the interests of all countries, irrespective of their degree of economic or scientific development, and shall be the province of all mankind". This paragraph was included to satisfy the aspirations of less-developed countries. Since 1989, the Committee on the Peaceful Uses of Outer Space (COPUOS) is studying the legal aspects related to the application of the principle that the exploration and utilization of outer space should be carried out for the benefit and in the interests of all States, taking into particular account the needs of developing countries. Up to now, no agreement has been reached because of the deep differences, especially relating to the legal regime of the geostationary orbit, existing between less developed countries. The latter countries claim that the geostationary orbit has to be considered the common heritage of mankind. Most of the delegations in the COPUOS agree that such a regime must guarantee to all States equitable access to the geostationary orbit, but the discrepancies remain with respect to how such access will be implemented.

Relating to the principle of non appropriation, article II of OST states that "outer space, including the Moon and other celestial bodies, is not subject to national appropriation by claim of sovereignty, by means of use or occupation, or by any other means". Appropriation is understood to include either the exercise of exclusive control or use on a permanent basis.

According to this principle, what about the legality of building lunar bases, for example, to manufacture solar power satellites? There is no clear answer, but we have to take into account that when the OST was negotiated, the overriding concern of article II was to avoid any claim of sovereignty over outer space, including the Moon, not to forbid production activities on the surface of the Moon.

The Moon Agreement, after having reiterated article II of OST in article 11.2, establishes that "neither the surface nor the subsurface of the Moon, nor any part thereof, or natural resources in place, shall become the property of any State, international intergovernmental or non-governmental organization, national organization or non-governmental entity or of any natural person. The placement of personnel, space vehicles, equipment, facilities, stations and installations on or below the surface of the Moon, including structures connected with its surface or subsurface, shall not create a right of ownership over the surface or the subsurface of the Moon or any areas thereof" (art.11.3).

Accordingly, it seems lawful, or at least not forbidden, to establish a lunar base to manufacture solar power satellites because such a base does not imply the extension of rights of ownership or sovereignty over the surface of the Moon. An analog exists with bases established in the Antarctic. Moreover, the legality of lunar bases is corroborated by article 12 of the Moon Agreement.

The Moon's resources, such as metals, glasses, oxygen, etc., appear to provide materials for the construction of the system of solar power satellites. The question then is, would the appropriation of extraterrestrial materials, in particular lunar natural resources, be banned by international space law?. This is a very controversial issue. Article II of OST forbids the appropriation of any part of outer space and celestial bodies, but neither the U.N. General Assembly Resolution 1962 (XVIII) nor the OST address the issue of appropriation of resources existing in outer space or in celestial bodies.

At first glance, the Moon Agreement may give us a solution. After declaring that "the Moon and its natural resources are the common heritage of mankind" (art.11.1), as we have seen *supra*, article 11.3

states that "neither the surface nor the subsurface of the Moon, nor any part thereof or natural resources in place, shall become property of any State" (the underlining is ours). But this solution has some problems. First, the Moon Agreement that entered into force on July 11, 1984, has only been ratified by seven countries (Australia, Austria, Chile, The Netherlands, Pakistan, the Philippines and Venezuela). The Moon treaty is the only space treaty that has not been ratified by the major space powers. Since no major space nation is a signatory, it is not generally accepted as binding space law. The Moon Agreement, to be relevant, needs the participation of the major space powers, in particular, the United States. That represents a huge handicap with respect to the legal relevance of its provisions. Second, according to some scholars, the use of expressions such as "shall" implies that the general character of the obligation prescribed in article 11.3 of Moon Agreement, is practically transformed to a voluntary option.

To safeguard the implementation of "the common heritage of mankind" principle, the States parties to the Moon Agreement, "undertake to establish an international regime, including appropriate procedures, to govern the exploitation of the natural resources of the Moon as such exploitation is about to become feasible" (art.11.5), with the main purpose of guaranteeing "an equitable sharing by all States Parties in the benefits derived from those resources, whereby the interests and needs of the developing countries" are considered (art.11.7, par. d). The problem is that such an "international regime" has not been implemented yet. Then the question is, does the provision for an international regime mean a de facto moratorium regarding the exploitation of natural resources on the Moon until the establishment of such regime?. Whereas many less developed countries, advocating a maximum of common heritage of mankind, would suggest such a moratorium, most others disagree because the OST, the Moon Agreement itself and its travaux préparatoires do not give evidence in law for the existence of a moratorium (again, the main aim of article II was rather to avoid any claim of sovereignty). Furthermore, in light of the preceding controversy on the U.N. General Assembly resolution 2574 D of December 15th 1969, when the moratorium on the exploitation of the resources of the sea bed and ocean floor was proposed, the United States delegates, twice alleged that there was no moratorium regarding the Moon. No other delegation challenged this assertion.

In spite of these circumstances no clear affirmation can be made concerning the existing lege lata. In our view, even in the legal absence of a moratorium, it is not clear that the exploitation of lunar materials does not go against the spirit of the Moon Agreement and specifically of the OST. Such an exploitation by any State will contradict the principles recognized in article I of OST: outer space "shall be free for exploration and use by all States without discrimination on any kind" (par.2), and "for the benefit and in the interest of all countries" (par.1). Furthermore, what is not forbidden is not necessarily allowed from the point of view of public international law. Thus, it is not possible to give a clear answer, legally speaking. However, from a perspective of lege ferenda (close to what is meant by common heritage of mankind), it would be unacceptable to perform any Moon activities on a larger scale.

Another issue related to the principle of non-appropriation is the use of solar beams, since a feature of solar power satellites is the large-scale utilization of the Sun's rays. In regard to this question, it seems suitable to consider the distinction suggested by space scholars between the appropriation of inexhaustible resources, such as cosmic beams or gases, which can be the object of appropriation, and the acquisition of limited resources, which is not permitted by the OST.

Hence, since solar energy is an inexhaustible and renewable resource of the space environment, it would be illogical and contrary to common sense to limit its utilization and appropriation by those able to capture and transmit it to Earth, lunar bases or other satellites. Also, the capture and use of solar energy in space is lawful as a principle of customary international law, since satellites have been making regular use of solar panels without objection from any State.

Regarding the appropriation of resources existing in the space environment, a transcendental question is raised in relation to the orbits, in particular to the geostationary one. As we know, the geostationary orbit offers great advantages for solar power satellites because, on the one hand, a satellite can receive from four to eleven times the amount of solar energy available to areas on Earth, and on the other hand, is available almost continuously except for short periods around the equinoxes. But, unlike solar beams, the geostationary orbit has been recognized as a limited natural resource (art.33 of the 1982 ITU Convention). Thus, according article II of OST, it cannot be "subject to national appropriation by claim of sovereignty, by means of use or occupation, or by any other means", since any contrary solution would imply a fundamental limitation to the principle of freedom of use of outer space.

However, up to now the use of geostationary orbit by numerous satellites, especially for telecommunications, has been a practice accepted by most States, in spite of the fact that such practice

implies theoretically an appropriation de facto contrary to article II of OST. Therefore, in principle and legally speaking, solar power satellites can use the geostationary orbit. We will discuss infra the problems that the use of geostationary orbit by solar power satellites implies.

Finally, we are going to review the principle that outer space is to be used for peaceful purposes. The operation of a solar power satellite system creates two kinds of dangers: the use of solar power satellites for military purposes (jamming of radio communications, heating of other space objects, power supply to military units, etc.) and possible vulnerability to the system since it could be supplying a large portion of a nation's electricity.

Article IV, par.1, of OST obliges States "not to place in orbit around the Earth any objects carrying nuclear weapons or any other kinds of weapons of mass destruction". It mandates the denuclearization of outer space and celestial bodies. This disposition is not too relevant for solar power satellites because, at least for the moment, it seems that the capability of solar power satellites to cause radiation damage (mass destruction) on the ground is small. More important is par.2 of the same article which states that "the Moon and other celestial bodies shall be used by all States parties to the Treaty exclusively for peaceful purposes." This disposition raises two closely linked questions: how is peaceful purposes defined and what about outer space itself?

Peaceful purposes, according to State practice, is interpreted as meaning "non-aggressive" [nonetheless, in some states like Japan, peaceful is understood as "nonmilitary".] A number of states, and particularly the United States, did not want to entirely forbid all military activities in outer space so long as such activities were not specifically for aggressive purposes. Therefore, with regard to the existing *lege lata*, it does not clearly ban the use of solar power satellites for military purposes. Hence, it is necessary to find a new legal formula, possibly in the new treaty, in order to eliminate, or at least to reduce the risk of possible military use of solar power satellites. Before the operational phase, it must be guaranteed that the solar power satellite system can only be used for strictly peaceful purposes.

To prevent the vulnerability of those States relying on the energy supplied by the solar power satellite system, a key question would be, who has effective control over the solar power satellite system in a time of crisis? It seems clear that if the solar power satellite is owned by a national government, the vulnerability of other States' interests is higher than if ISPO is run by a multilateral consortium. This was an incentive to establishing a multinational regime to operate the solar power satellite system.

5.3.2 The Utilization Of Earth Orbits And Radio Frequency Spectrum

The solar power satellite system would use two natural resources, Earth orbits and the radio frequency spectrum. The geostationary satellite orbit, among Earth orbits, is preferred for most services, due to operational and economical advantages. Solar power satellites would make use of the radio frequency spectrum for two purposes, telecommunications and microwave or laser beam transmission.

The allocation of geostationary orbital positions and the radio frequencies cannot be separated from one another if appropriate coordination and regulation are to be achieved for any space services. De facto, ITU has competence to deal with geostationary orbital positions in view of orbit/spectrum inseparability. The main problems for solar power satellites are that the geostationary orbital segment has its physical limitations, which implies the danger of collision with other satellites as well as possible electromagnetic interference with other services using the radio spectrum.

A preliminary crucial issue pertaining to ITU is whether it would have competence to deal with the allocation of solar power satellites and the transmission of solar energy to Earth using microwaves or laser beams. According article 4 of the 1982 ITU Convention, the purposes of the Union are: a) "to maintain and extend international cooperation for the improvements and rational use of telecommunications of all kinds", and b) "to promote the development of technical facilities and their most efficient operation with a view to improving the efficiency of telecommunications services, increasing their usefulness and making them, so far as possible, generally available to the public."

Thus, it is clear that the ITU has the authority to deal with "telecommunications". In article 1 of ITU Radio Regulations, "telecommunications" is defined as "any transmission, emission or reception of signs, signals, writing, images and sounds of intelligence of any nature by wire, radio, optical or other electromagnetic systems." The question is whether the use of microwaves or laser beams for power

transmission involves transmission of "signs, signals, writing, images and/or sound of intelligence." No clear answer can be given.

Nevertheless, it might be pointed out that one of the functions of ITU is to coordinate uses of the radio frequency spectrum in order to avoid harmful interference between radio stations and to coordinate efforts to eliminate such interferences. Since a solar power satellite system would use the radio frequency spectrum, it would be contrary to common sense to hold that ITU does not have competence to deal with microwave or laser frequencies for purposes of power transmission.

An additional political consideration with respect to the ITU is the role of COPUOS in regulating the geostationary orbit. It is possible to foresee that any initiative on the part of COPUOS to regulate solar power satellites will fail, because of a lack of support on behalf of the major space powers. It is well known that major space powers have denied the competence of COPUOS to regulate the use of the geostationary orbit. The only possibility seems to be that the COPUOS could establish criteria for equitable use of the geostationary orbit according to ITU regulations.

The conclusion that emerges with respect to the issue of orbit/frequency allocation for the solar power satellite system is that ITU has competence to deal with such issues. Besides, this conclusion has also been supported by unofficial views of ITU functionaries, especially in the International Frequency Registration Board (IFRB) of 1978, which reviews and records frequencies assignments made by the national administrations. Also, one year later, a 1979 WARC Resolution recommended the same solution.

Up to now, the ITU has been entrusted with the responsibility of working out rules and procedures with a view toward maximizing the geostationary orbit and frequency spectrum's efficient utilization and preventing harmful interference. Harmful interference is defined by ITU as "any emission, radiation or induction which endangers the functioning of a radio-navigation service or of other safety services, or seriously degrades, obstructs or repeatedly interrupts a radio-communication service operating in accordance with the Radio Regulations."

The ITU over the years has reiterated the need for the rational and equitable use of the geostationary orbit and the radio frequency spectrum for space services. Nowadays, article 33.2 of the 1982 ITU Convention (modified, but not yet in force, in the Plenipotentiary Conference of Nice, June 1989) states that "in using frequency bands for space radio services, Members shall bear in mind that radio frequencies and the geostationary satellite orbit are limited natural resources, and must be used efficiently and economically, in conformity with the provisions of the Radio Regulations, so that countries or group of countries may have equitable access to both, taking into account the special needs of the developing countries and the geographical situation of particular countries".

So, specifically with respect to the use of the geostationary orbit, provisions have been made in the WARC (79), RARC (83), WARC-ORB(1) 85 and WARC-ORB(2) 88 to reconcile the principle of efficient and economical utilization with the principle of equitable access for all countries. In any case, ITU provisions do not meet the hopes of the less developed countries in the regulation of the use of the geostationary orbit.

With respect to a solar power satellite system, in the 1979 ITU WARC, it was decided that solar power transmission would fall into "Industrial, Scientific, Medical and other Applications" service, which includes any use of microwave for purposes other than telecommunications (art.1 of ITU Radio Regulations). Nevertheless, it was also decided that solar power satellites as such would not be defined as a new service. Therefore, there are no frequencies bands allocated for power transmission systems. Allocation of a frequency band is defined in article 1 of ITU Radio Regulations as the "entry in the Table of Frequency Allocation of a given frequency band for the purpose of its use by one or more terrestrial or space radio communication services or the radio astronomy service under specified conditions." This means that if a solar power satellite system provider wants to get access to some frequency bands, those responsible would have to initiate the procedure in front of the IFRB to ensure the avoidance of harmful interference. [Concerning the procedural framework, see WITHERS & WEISS, 1984, pp.282-289].

With power transmission systems, there are basically two options, microwave beams and laser beams. The major advantage of laser beams is that they could be operated in low Earth orbit rather than in the geostationary orbit. However, microwave beams are at present the favored option because of their higher conversion efficiency. For microwave power transmission, the frequency of 2.45 GHz or at least one of the so-called ISM bands, is close to optimum because of its higher transmission efficiency. The problem is that these frequency bands are already allocated to other services and are in great demand. It appears that the only frequencies available for a solar power satellite system are

located in the bands surrounding 30 GHz. This played into the final design decision for the ISPO demonstration project. The trouble with the higher frequencies is that they are subject to atmospheric interference. To avoid loss of efficiency, the rectennas should be located in drier areas such as the Sahara desert.

It is obvious that the positioning of solar power satellites in geostationary orbit can imply important hazards of collision and other types of damage including that resulting from the passing of a satellite into the down-link of a microwave beam. Moreover, a solar power satellite system will present keen competition for the orbital slots if such a system is implemented. This is one of the reasons why it is inevitable that solar power satellites policy will be a matter of "high politics." This means that decisions about how to distribute the geostationary orbit between solar power satellites and other kinds of satellites will be made by the political leaders of major nation-states in the context of an international political debate.

5.3.3 Technology Transfer & Intellectual Property

Technology transfer refers to the regime that has been established on both an international and national level to prevent the transfer of technology where such a transfer threatens national security, foreign policy interests, or near-term commercial space interests. On an international level, the Coordinating Committee on Multilateral Export Controls (COCOM) was set up specifically to prevent the transfer of munitions, atomic energy, and industrial commercial technology to Eastern countries. The Missile Control Technology Regime (MCTR) is another international organization established specifically to counter nuclear missile proliferation. Of concern is the conversion of space launchers to nuclear weapons technology capability. However, since the breakdown of Eastern Europe, the continuing role of COCOM has been questioned, and international regulations have been relaxed. At the national level, regulations vary greatly. International industrial competitiveness concerns continue, and as such, export controls remain. Within the United States, as an example, the transfer of technology, which includes hardware, know-how, training information, and engineering specifications, is restricted through export licenses. Individual contractors need to apply for the export license through the Department of State. Such licenses are strictly regulated.

Technological contributions to the ISPO from participating countries can be done in exchange for cash, or can be done in-kind. Specifically, as it relates to Space Solar Power Program, such transfer of technology must be considered on both the organizational level and on the contractor level.

International Solar Power Organization

The best way to work around what might otherwise be a formidable technology transfer roadblock is to require that technical interfaces be kept simple. Moreover organizational access to contractors' technological information will be restricted to those individuals who have a "need to know" such information based on a "common interest" in the ISPO. This further protects contractor proprietary information. Furthermore, organizational participants would be restricted from making contractor technical information available outside the organization.

Individual Contractors

Contractors contributing technology to the ISPO effort would be subjugated to the export controls restrictions found in their own national laws. With the growing international interest in joint programs, such export licenses might be more readily obtained. Certainly securing top level political support at the national level will facilitate the issuance of export licenses. As an example, the U.S. recently agreed to consider issuing an export license to launch an INMARSAT satellite on a Russian Proton launcher. Even one year ago, such an agreement would not have been conceivable. So the opportunities for international cooperative efforts are increasing as national governments adopt policies which encourage international joint ventures.

If more than one country participates in the development of an object provided as a single, in-kind contribution, bilateral agreements will have to be concluded on technology transfers and intellectual property. This can be accomplished through a joint venture agreement.

Intellectual Property

Intellectual property is a generic term consisting of industrial property such as patents, copyrights, know-how, trade secrets, utility models, industrial designs, trademarks and service marks. Where

current technology is used in the space solar power program, the rights to intellectual property will remain vested in the contractor or subcontractor. Where new technology is developed as part of a space solar power program contract, resulting intellectual property rights will be exclusively retained by the ISPO and commercialized where applicable. The proceeds from such technology, when licensed to third parties, or otherwise commercialized by the ISPO, will be distributed to the Signatories, based on their proportional representation on the Board of Governors.

5.3.4 Some Responsibility And Liability Issues Surrounding Solar Power Satellite Activities

Providing energy from space through the use of a solar power satellite implies some risks. First, there are those general hazards involved in practically all space activities. These are the risks to persons or property caused by space objects either in flight or when falling down to the surface of the Earth; and, second, we have the specific risks linked to the production of energy using solar power satellites. In effect, the microwaves or laser beams used to transmit energy to the ground can produce many adverse effects in the environment (ionospheric heating could disrupt telecommunications, tropospheric heating could result in minor weather modifications, damages to ecosystem, potential interference with satellite communications, etc.). However, many of the effects are not well understood and some may have long-term health consequences. Other potential impacts include land despoilment caused by rectenna construction.

With regard to general risks such as collisions, debris that may eventually reach Earth causing terrestrial damages, etc., according to article VII of the OST, each State that launches or procures the launching of an object into outer space, or from whose territory or facilities an object is launched, is internationally liable for damage to another State or to its natural or juridical persons by such object or its component parts on Earth, in airspace or in outer space. This is completed by article VI which provides that it is the State which is to bear international responsibility for national activities in outer space whether such activities are carried on by governmental agencies or by non-governmental entities. States are also obliged to ensure that all space activities of their non-governmental entities are carried out under their authorization and continuing supervision. When activities are carried on in outer space by an international organization, responsibility shall be borne both by the international organization and by the States participating in such organization.

These provisions raise some problems. On the one hand, there is no legal definition of "space object". In reality, this term is only used in the context of the registration issue, pointing out the relevance of registration to determine the jurisdiction and control over a space object and its crew.

Moreover, space treaties cover objects launched into space but no mention is made of objects assembled in space, which could be done in the case of solar power satellites. This shows the inadequacy of the space treaties, in particular of the Registration Convention, with respect to solar power satellites. A solution, possibly similar to the one adopted in article 5 of the Space Station Freedom Agreements is needed. In spite of the fact that a clear answer cannot be provided, since article VII of the OST and article I (d) of Liability Convention defines "space object" as including "component parts", and since the payload of an object is likely to be a component part, it seems possible to support the conclusion that stored materials launched into space are covered by the liability regime of space law. However, if the payload of a satellite is not held to be covered by the definition of space object, or if the solar power satellites are manufactured in space and there is no launching from the Earth, it is arguable that the Liability Convention and article VII of OST would not apply.

The OST is supplemented by the 1975 Registration Convention, which in article II establishes the mandatory registry of any space object launched into Earth orbit or beyond, and in article IV forces the launching State to provide, as soon as practicable, information about the name of the launching State, basic orbital parameters, and its general function, etc.

Besides, the provisions of article VII of OST have been elaborated upon in the Liability Convention. While the OST contains no definition of the term "damage", article I of the Liability Convention defines damage as "loss of life, personal injury or other impairment of health; or loss of or damage to property of States or of persons, natural or juridical, or property of international intergovernmental organizations." Moreover, it establishes two types of liability: absolute for damage caused on the surface of the Earth or to aircraft in flight (art. II), and fault-based for damage caused elsewhere (art. III). Furthermore, whenever two or more States jointly launch a space object, they are jointly and severally liable. Thus, the State claiming damages may obtain full payment from any or all of the launching States (art. V). The principle of joint and several liability also applies to intergovernmental

organizations and their member States when the damage is caused by a space object belonging to such organization (art. XXII).

The application of these rules on liability can raise some problems due to the fact that the orbits of orbiting spacecraft do not remain fixed with respect to the Earth, to each other, or to any system of coordinates. Thus it is difficult to design general rules for establishing responsibility for collision between spacecraft. Furthermore, in the case of damage caused by space debris, the identification of the legal person responsible for each piece can be a complicated task.

Finally, it is necessary to take into account that the Liability Convention is not applicable to damages caused by a space object of a launching State to nationals of such State, and to foreign nationals during such time as they are participating in the operation of the space object (art. VII).

In relation to the specific risks surrounding solar power satellite activities, it becomes clear that it is very difficult to include some categories of risk into the existing *lege lata*. Let us break down such risks contemplating the existing international space law regime. A major problem arises from the fact that the microwaves or laser beams are not a space object. Then, the question is: will the damages produced by microwaves be covered by the liability regime of space law? In this issue, as some scholars suggest, we can make the assumption that microwaves are components of the solar power satellites, or at least of the system, and then any effects of microwave radiation having physical damages would be covered by the liability regime of space law.

Still more problematic is finding out whether such a liability regime extends to interference with communications passing through the beam or to harm caused to the environment, etc. when it does not result in impairment of health or damages to property. It has been argued by space experts that damage caused by transmission of microwaves is not covered by existing space law. Then, it seems that the only recourse for such harms must be through the consultative provisions of article IX of the OST. These establish that States shall pursue studies and conduct exploration of outer space so as to avoid its harmful contamination and any adverse changes in the environment of the Earth resulting from the introduction of extraterrestrial matter. Where States have reason to believe that their activities in outer space would cause harmful interference with activities of other States in outer space, they must undertake appropriate international consultations before proceeding with any such activity. The State to be affected may also request consultations concerning the activity of the State in question. Since the meaning of the term "consultations" in public international law is unclear, the effect of this article is diluted. In any case, it is clear that there is a duty to consult the state which may be affected, but it cannot unilaterally foreclose the activities of other States.

Hence, there is a clear need for the elaboration of space law in this area, since under general international law there is no generally recognized duty to compensate damages caused as a result of lawful activities. Therefore, nowadays, international law does not offer enough guarantees to States. Besides, it is not clear whether the International Law Commission considered such kinds of damage in its Draft of articles 1 to 10 on International liability for injurious consequences arising out of acts not prohibited by international law.

Thus, once again, we have to insist that a progressive development of international law on this matter is necessary. It would be suitable to establish an international agreement in which States will assume absolute international responsibility for all kinds of damages caused by any system providing energy from space. The commercial exploitation of solar energy from space will require an international legal regime that is more comprehensive.

Finally, since there is no international standard for exposure of humans (or other beings) to microwave or laser beam radiation. It is necessary to obtain an appropriate international agreement on microwave exposure standards. Nowadays, standards of maximum permissible exposure for laser beams do not exist and State practice is not uniform with regard to microwave beams. The U.S standard is 1 milliwatt per square centimeter, the Russian standard is 10 microwatts per square centimeter, and most other nations have standards in between. The permissible radiation level has an impact on the size of solar power satellites, on the method of its control and operation, and on the size of buffer zones around rectennas. In establishing such standards, it would be useful to take advantage of the experience of the World Health Organization and studies of the International Atomic Energy Community. The ITU also offers some guidance. The ITU International Radio Consultative Committee (CCIR) has defined the scientific parameters of "free space energy transmission by microwaves" as "the point to point transfer of energy through free space by a highly collimated microwave beam".

5.3.5 Insurance

Space ventures are high risk endeavors. Since the ISPO is international, and will not be incorporated under any national law, the Signatories will not be able to avail themselves of the protection afforded by limited liability. Therefore, exposure to risk, through other instruments, takes on increased importance. The ISPO will purchase insurance, negotiate for liquidated damages and/or manufacturer/contractor/subcontractor warranties in order to cover the following risks:

- inexcusable delays by contractors or launching parties
- nonperformance
- prelaunch storage
- launch procedures up to, but not including, intentional ignition
- intentional ignition to delivery in orbit
- inorbit insurance against system and subsystem failures
- third party liability
- collision of registered space objects with other space objects
- damage to terrestrial objects

Cross-waivers

To control for risks within the membership of the ISPO, each Signatory and the ISPO shall be required to waive all claims against all other Signatories with the following exceptions: death, dismemberment, bodily damage, and willful acts including sabotage. Contractors and subcontractors may also be invited to join this reciprocal regime for those risks not expressly provided for with insurance, liquidated damages, and/or warranties.

5.3.6 Dispute Resolution

Mediation, Litigation, and Arbitration are methods of resolving disputes.

Mediation is an informal means of dispute resolution where the mediator acts as a neutral facilitator to aid the parties in resolving their own dispute. The mediator does not act as a decision-maker but rather as a neutral party who does not render judgments. It is therefore not an assured method of achieving closure of the dispute.

Litigation is pursued by means of the judicial process. It is a formal process which utilizes the courts established by governments. International litigation is especially complex, costly, and time consuming.

Arbitration is pursued by non-governmental private bodies following a process which is similar to litigation. The salient differences between litigation and arbitration are that the parties in an arbitration choose their decision-makers, who are therefore often experts in their fields, thereby relieving the parties of the burden and expense of educating the decision-makers about the technological subject matter of the dispute. Since it is a private contractual matter, the parties are not subject to the docket schedules of the various court systems. By contractual means they can also choose the law that will govern the dispute and the location of the arbitration. These contractual aspects of arbitration can substantially reduce the significant uncertainty usually associated with international dispute resolution. For the reasons stated above, arbitration is recommended for the ISPO, especially due to the complex, technical and international nature of the transactions contemplated. Because of the importance of the dispute resolution mechanism, the following draft is offered for consideration of the Signatories for incorporation in the ISPO Charter at the ISPO Founding Conference:

Arbitration

Unless otherwise settled by the Signatories, all disputes between a Signatory and the ISPO which may arise out of, or in connection with, the ISPO, or for the breach of any contract or agreement to which the ISPO organization is a party, shall be finally settled by arbitration.

Waivers

The waiver of the ISPO or any Signatory of any right or of the failure to perform or breach by another, shall not be deemed a waiver of any other right or of any other breach or failure by said party.

Notices

Any notice, in order to be effective, shall be in writing and shall be deemed served if sent by registered mail, with return receipt requested, addressed to the attention of the President (if a corporation) or Director (if a governmental agency), at its principal office and address or at such other address as may be designated in writing.

Applicability of Supervening Law and Severability of the Arbitration Clause

This Arbitration Clause shall be subject to and construed in accordance with the applicable laws, provided, however, that if any provision of this clause shall contravene the laws of, or require the approval of any governmental authority or agency, the same shall be ineffective to the extent it is in contravention of such laws, or until such approval shall have been obtained, without invalidating the remaining provisions.

Incorporation and Survivability

This Arbitration Clause shall be incorporated in any contract or agreement to which the ISPO organization is a party, and shall survive any breach of such contract or agreement and shall be enforceable after any breach of said contract or agreement.

5.3.7 Schedule

Table 5.1 Legal Questions, Tasks and Durations

Technical Questions	Resulting Tasks	Estimated Duration
Which ITU Service Category Does Space Solar Power Program Fall Into?	File Application Lobby Hard	1 Year Prior To Technology Demo For The ITU Application File Application Lobby Hard
Which Frequencies And Orbit Slots Are Available (Which Are Preferred Based On Engineering Specification)?		
What Legal Format Is Best And Which Parties/Countries Will Participate?	Look To Other Models. Begin Drafting Documents	Begin 1 Year Prior To Formation Of Organization For IGA Or MOU
What Organizational Structure Will Maximize Charter Goals?	Get Top Level Government Approval To Permit Export	At Least 1 Year Prior To Formation Of Organization: JV Profit/Nonprofit
Will Technology Transfer Be Restricted?	Coordinate With All Parties To Best Represent Their Interests	Export Licenses/ /Technology Transfer Approval (As Needed)
Predisposed To Choose Arbitration But Consider Options Of Litigating And Mitigating		Determine Dispute Resolution Form. Part Of Negotiation Process
Just Retour Or Open Bidding	Examine Political Economic Trade Offs Consult JV Agreement And Board Of Directors	Contractor/Sub Request For Proposal And Awards. (As Needed, RFP Take About 9 Months / 1 Year)
What Category / Classification Of Space Object ?	Administrative Effort	Register Space Objects With United Nations 6 Months Before Launch
When Is The Payoff And How Much?	Consult JV And Board Of Directors	Distribute Dividends (Once You Are Commercially Profitable)

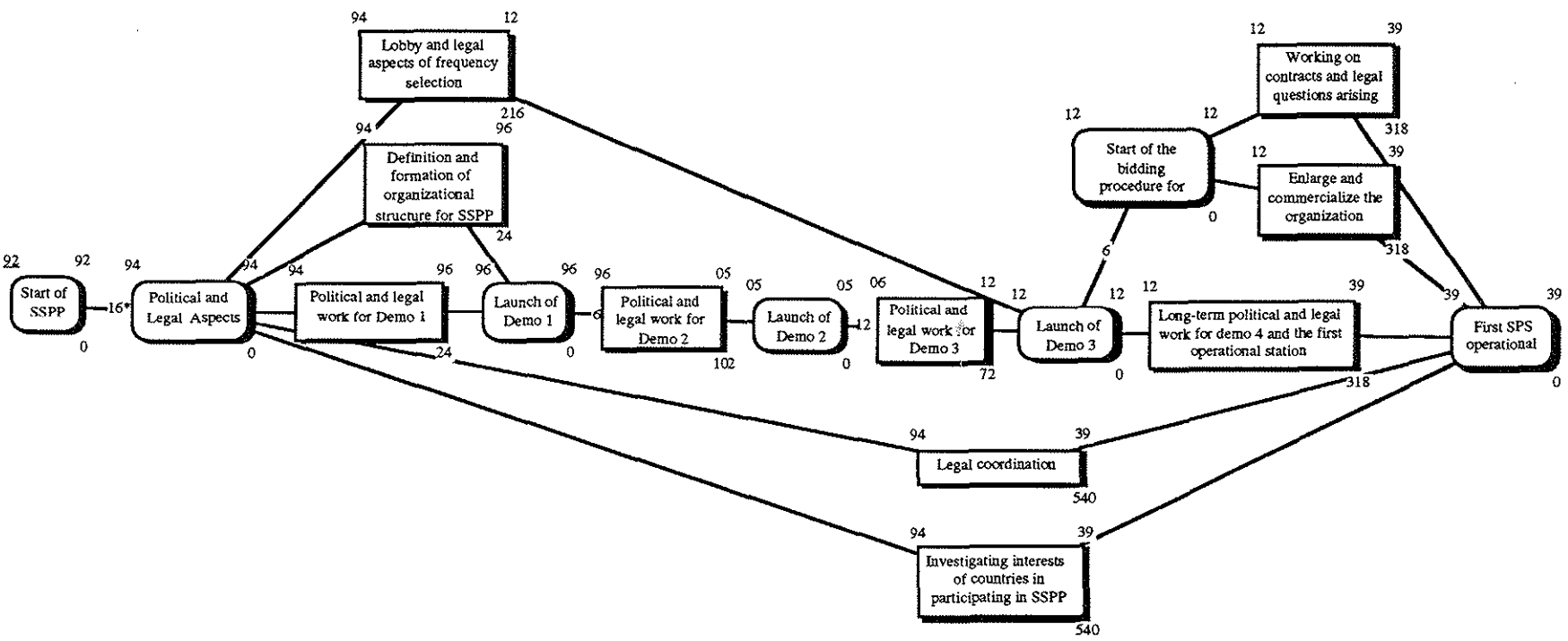

Figure 5.4 Political and Legal Task Schedule

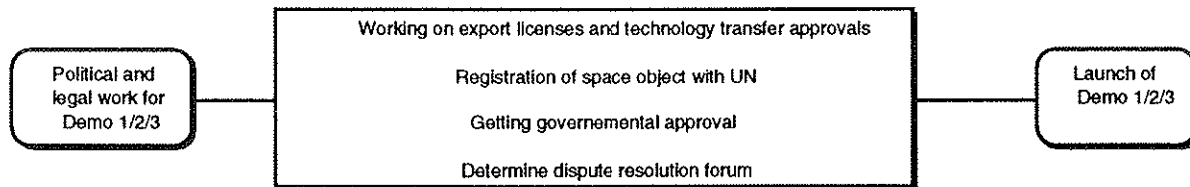

Figure 5.5 Political and Legal Tasks for Demo (1,2,3)

Remarks:

- DEMO1 Earliest start: Jan 1994 Latest finish : Jul 1996
 DEMO2 Earliest start: Jan 1996 Latest finish : Jan 2007
 DEMO3 Earliest start: Jan 2007 Latest finish : Jan 2017

Registration takes place 6 months before each launch.

Top-level governmental approval requested for DEMO3

Orbit selection not requested for DEMO1

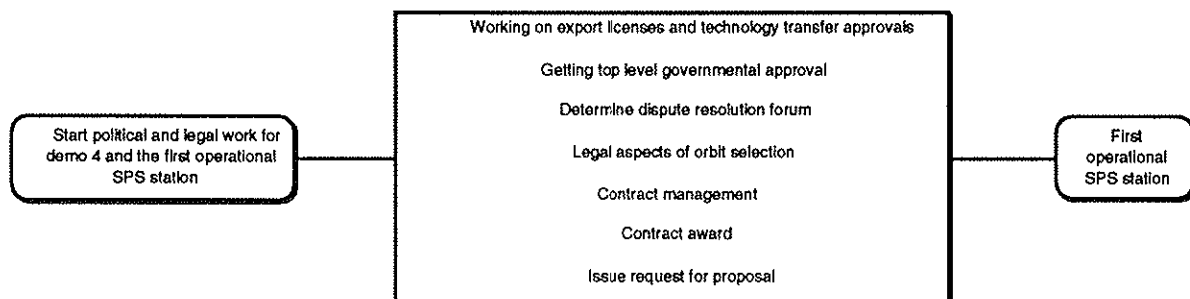

Figure 5.6 Long Term Political and Legal Tasks

Remarks:

- DEMO4 Earliest start: Jan 2019 Latest finish: Jan 2027
 First Space Station Earliest start: Jan 2030 Latest finish: 2039

5.4 Security Issues

According to a Gallup survey taken in the late 1980's, the Japanese economic threat was considered more serious than the Soviet military threat by the American public. As clearly indicated by this example, the end of Cold War has shifted the world focus from military activities to economic concerns, from the arms race to industrial competition. Moreover, in recent years, industrial competitiveness issues have become closely intertwined with remaining national security considerations.

The world's focus in terms of national security has also shifted from the former Soviet Union and Eastern European nations to the politically unstable Middle East. The Gulf War, which was caused by Iraq's invasion of Kuwait in 1990, highlighted the danger of militarily sophisticated, politically unstable governments. Large scale conflicts are giving way to regional conflicts which often involve nations outside the region of conflict. In this respect, the transfer of military technologies to politically unstable nations can be threatening to international security. Besides the clear economic threat and any new military threat, there is also some danger involved in increasing global interdependency through a global technological network.

In this section, security issues associated with a solar space power program are discussed. This part is divided into three sections. The first section is concerned with technology transfer. There are two issues identified under technology transfer through the ISPO. One is the military threat of politically unstable nations. The other is the economic threat of industrial competitors. The second section examines the increased vulnerability and interdependency among participating nations due to the technological characteristics of a space solar power program. Finally the final section provides some tentative solutions for dealing with potential security issues as discussed.

5.4.1 Technology Transfer

Transfer of Military Technology

The investigations by the IAEA missions to Iraq stunned many of the UN officials involved in international security and disarmament. Although Iraq is a member of IAEA, and thus, bound by IAEA regulations not to develop nuclear weapons, it was revealed that Iraq was close to completing production of a hydrogen bomb. All the necessary facilities had already been constructed.

This incident revealed the weakness of international regulations in controlling transfers of military technology as well as the potential danger to international security resulting from the transfer of such technology to politically unstable nations or military states. With the end of the Cold War and the collapse of one of two nuclear superpowers, all-out nuclear wars have become unrealistic. However, this does not mean that there is less of a chance for open military conflicts or isolated attacks. Rather, the probability of all-out nuclear war has been lowered.

It is planned that the technologies developed under the ISPO will not present a significant military potential. However, transfer of technologies that might allow the recipients to increase their own military potential should be avoided at all costs.

In addition, any possibility of the transfer of militarily applicable technologies, even among politically stable and non-aggressive nations, will make the situation difficult for some nations to participate in ISPO. Japan is a good example. At this time, Japan is, in principle, still against the transfer of even dual-use technologies, which can be used for both civilian and military purposes.

Transfer of Critical Technology for Industry

As discussed in the first part of this chapter, the world focus has shifted toward economic competition. Industrial competitiveness has become a crucial factor in determining national security from an economic point of view.

In recent years, there has been much discussion on the correlation between technology transfer and industrial competitiveness. Especially in the United States, which is struggling to regain its industrial competitiveness, the argument of "techno-nationalism" has become prevailing. This argument was once used in the first half of 1980's to criticize Japanese industrial policies which aim to protect target industries through governmental efforts. However, in recent years, it has assumed another meaning, which is governmental efforts to protect critical technologies for industry by limiting technology transfer to other countries. Such a practice by governments is not new. However, the point here is that many nations, especially the United States, have become extremely sensitive to protecting the transfer of any technologies which might convey commercial potentials, especially in the near-term.

Since initial participants of the ISPO are likely to be those nations which are already competing with each other in other areas of economic activity, regulations and arrangements for technology transfer will be crucial for the initial success of the program. Considering the fact that there are relatively high expectations among the decision-makers of the United States and European nations for economic payoffs from space spin-offs, it is not too much to say that the technology transfer issue could determine the success or failure of the program.

5.4.2 Increasing Vulnerability and Interdependency

While transfer of militarily applicable technologies and commercially critical technologies can be effectively prevented for some time, there is some inevitable danger in any kind of global system, i.e., increasing interdependency among nations within the system. The space solar satellite program is expected to develop as a global system of energy production and distribution, with its facilities placed around the world and outer space. But of concern is the fact that the space solar power satellite program could become a target for terrorists. Destruction of critical facilities might cause a global panic, once the program develops to the point that it would affect most of the nations on the Earth. This part is divided into two sections. The first section examines the possible impacts of terrorism on the ISPO. The second section is concerned with the inevitable interdependency in a global system and related national security issues.

Since the ISPO will provide an alternative energy source on which more and more industrial as well as social activities can be dependent in the future, the possibility that the ISPO becomes a target for terrorism cannot be ignored. In addition, social impacts of terrorist attacks on the system can be

enormous. As the dependency on space solar power increases in the long-term phase, insuring against sabotage is very important.

Besides potential open military aggression against a space solar power program, there is also some possibility of political and economic sabotage against the program. Those oil powers, which have been enjoying profits through export of a limited energy source, will feel threatened should they lose their relative control over the global energy market. Especially if the space solar power satellite program is carried out by only industrialized nations, excluding those oil powers, even in the long-term phase, they might decide to impose an oil embargo to raise the price of this commodity in order to secure profits before space solar power becomes operational or commercial. This would induce another oil crisis. Another scenario is that oil powers may form a coalition with developing nations, which have always been making efforts to secure their potential benefits in space, to become active against the space solar power satellite program at an international forum. For example, at the level of United Nations conferences, those developing countries, through the present voting mechanism, can effectively stall the creation of a legal framework favoring space solar power satellites. Power balance between current oil powers and emerging energy powers should be considered along the progress of this program, and inclusion of developing nations in decision-making process at some stage can be crucial for the success of the project in a long time period.

As for economic sabotage, there is also some possibility that some of the participating nations which have critical ground facilities, such as rectennas in their territories, might block access to those facilities. The possibility of such may increase if conflicts between the North and the South intensify. Although those advanced nations, which are likely to have good control over their own space facilities, can take effective counter-measures by stopping the power-beaming from space to those ground facilities. However, the potential problem remains.

In addition to the dangers of potential terrorism and political and economic sabotage, there is also the inevitable danger of increasing interdependency among participants. Needless to say, a space solar power program optimally would not be operated by any one country. Problems surrounding the program in any given participating nation will affect all participants to a certain degree. All the nations involved in this program may suffer if some critical accident occurs in even only one of the participating nations. This becomes more realistic as the program develops in the long term phase, involving more nations and even more dependents on this source of energy. To avoid such a situation, one solution is to create spare systems in case of malfunctions, but this may be financially unacceptable.

5.4.3 Concluding Remarks

Due to the collapse of the bipolar system and the emergence of a multi-polar system as well as a rough power balance between oil powers, developing nations and industrialized nations which are likely to be involved in the ISPO, there are various complicated issues related to national security and industrial competitiveness. Nevertheless, there are two major factors which can effectively control those issues. One is the inclusion of oil powers and developing countries in the decision-making process, at least in the later stages of the program. The other factor is making careful arrangements for technology transfer. While maximum attention should be paid to reduce threats to the industrial competitiveness of the providers of technology, there should also be much concern over the transfer of militarily applicable technologies. Tentative political solutions to control technology transfer would be to create the following two organizations.

One is a watch-dog committee to assure fair commercial competition among the participants utilizing products of a space solar power program. Another possible organization is an IAEA-type committee to watch technology transfer to those countries which lack technological capability to participate in the research and development of the ISPO program. In the instance where new technologies are transferred under a limited use context, a nation should accept regular investigations by such committees to ensure its proper and limited use.

Due to its unprecedented scale in the context of the new international political regime, the space solar power program, in the long-term, certainly creates formidable tasks to successfully manage potential security problems. It is very unlikely that any existing system for national security will successfully manage those problems, and some innovative initiatives may have to be taken in the future.

5.5 External Relations

In 1972, Gerard K. O'Neill experienced an event which would change his life forever. O'Neill was met with strict opposition by the academic publication community in his search to publish his first works on space colonization and manufacturing. Brian O'Leary, a close friend and a space enthusiast, encouraged O'Neill to bypass the traditional process and suggested to "Take it to the people". That simple but eloquent phrase led to the first of many successful lectures given to space enthusiasts throughout the United States. Space conferences soon followed and received considerable attention from the media. Within three years of the first lecture, the idea of space colonization and manufacturing was investigated by top NASA scientists and research in this area has continued ever since. ISU and the space solar power program are indirectly linked to this effort.

Two important points should be noted in this discussion. The first is the power received from approaching the people. The second is the will to search for alternatives. External relations plays a key role in the promotion, education and acceptance of the space solar power program and the following section will discuss these issues in relation to governments, industry, international organizations, the scientific community and the general public.

5.5.1 External Relations with Governments, Industry and International Organizations

The founding conference of the ISPO and ongoing activities thereafter will require a great deal of interaction between the relevant players. It is essential that these groups receive the information required on the goals of the space solar power program and the benefits that it provides. Every group, however, will be approached differently. A strategy must be developed to address each group differently with well-defined objectives for each. The public relations branch of the organization will have the mandate of identifying the potential members, developing and executing the various strategies and providing the relevant material for each member.

Approaching Governments

One of the main objectives of any legitimate government involves the national interest of the people which includes maintaining or increasing the standard of living for their citizens. Energy is an integral part of the standard of living. A method for increasing and, at the very least, maintaining a standard of living is the space solar power program. A project of this magnitude, however, will need the political will and support, both in terms of financing and financial liability.

Governments must therefore receive information on the space solar power program which relates to their national interests. In particular, the goals of the developing countries will differ significantly from those of developed countries. This section will present the different approaches used for both developed and developing countries.

Developed Countries

The developed countries have a well-developed energy infrastructure and the future energy demand in these countries is assumed to be less than those in developing countries. Therefore, a strategy based solely on energy demand would not convince developed countries to participate in the space solar power program at a level necessary to complete the project. The space solar power program should aid developed countries from multiple viewpoints. The following is a list of possible reasons why developed countries would participate in the space solar power program.

- Non-sustainable energy sources will eventually dwindle;
 - Countries who do not have energy self-sufficiency lose a certain amount of sovereignty;
 - A great deal of funds are spent each year in protecting existing energy supplies. An example is the US military presence in the Persian Gulf for consistent continuous supplies of oil from the Middle East;
 - There exists increasing opposition to existing energy supplies from environmental groups and the general public; and
 - Developed countries are given leadership roles in the pursuit of world stability and harmony.
-

Once a country is made aware of the potential benefits of the project, a process must begin to include space solar power in their political mandate and to appropriate the funds for the ISPO. In the United States, for example, both these tasks require the formation of an insiders' group consisting of the president's offices, senators, and congressmen. This is absolutely necessary in order to prevent alienation and generate support from a wide range of groups. This process typically takes several months on the average and often, up to a year to define the appropriate reasons to pursue the venture. Once the funds are appropriated, the US government would not be allowed to invest directly into the ISPO. It would therefore place the funds into an interim agency for investment in the project. Intelsat is an example whereby the US places shares in this organization via Comsat.

Developing Countries

A developing country will have completely different reasons to participate in the project. Typically, a developing country has or will have a need for energy but with the lack of resources to acquire it. Their need is urgent, which requires that solutions are needed immediately. Although near-term solutions are seemingly remote, the ISPO has devised a method to include the developing country in the project (refer to section 5.2.1). Governmental aid diverted to the space solar power program in an equitable distribution scheme will provide the incentives necessary for full participation. Possibly, aid could be given in proportion to the amount of existing energy sources not spent by a developing country. This scheme, albeit not perfect, represents a compromise between the forces of pure economics and humanitarian aid.

Approaching International Organizations

The international community will play a major role in the project at the support level, in part financial but mostly in the form of recommendations, public support and awareness and in contributions in kind. Possible international groups include the United Nations (UN), the G7 and other specific groups.

The UN would be an ideal forum for the exchange of ideas at the global level on the distribution of benefits and costs of the project. Although it is unlikely that the UN would form a special sub-committee on space solar power, it may be possible that a world energy sub-committee, if not in existence already, address issues related to space solar power. At that point, their mandate could include mechanisms in establishing inclusivity of all nations in space solar power program, qualifications of which country is in the development phase (refer to section 5.2.1), and coordination of the activities between governments and international organizations in the space solar power program.

In order to promote the benefits of space solar power, it would be desirable to publicly support the project during an economic summit, possibly through the G7. This seems unlikely at the present time but would probably occur just prior to the large scale solar power satellite program. For the moment, efforts should not be concentrated in this high-level forum until the project is viable technically and economically.

Other international groups should help in the overall development and support of the project. Possible groups include the International Telecommunications Union (ITU), the World Health Organization (WHO) and the World Meteorological Organization (WMO). These groups have specific interests and demands which should be addressed in order to support overall inclusion. At present, very little information exists on these demands and hence, it would be the responsibility of ISPO's public relations group to investigate these demands.

At this stage, it is important to mention the strategies of timing and disclosure for the space solar power program. In order to capitalize on the support of the politicians and the people they represent, the energy demand and its effects on the environment must be at the top of the public conscious. Unfortunately, this awareness is due, in most part, to the current crises presented by the media. Examples would be the energy crisis of the 1970s, the Persian Gulf war and environmental disasters such as the oil spill of the Exxon Valdez. Although unfortunate, these occasions represent opportune times to present the benefits of the space solar power program and to raise public support. Such timing strategies should be included in the overall external relations plan.

Approaching Industry

Sometime, in the hopefully not-to-distant future, when the demonstrations will have been proven successful and a decision is made to move towards a large scale program, the industrial community

will no doubt wish to participate in this profit-making venture. Until that time, however, their role will that of an observer, waiting for the moment whereby their participation will be most beneficial. It is therefore important for the public relations group to keep the industrial community well informed on current and future activities of the program. In addition, this group should offer suggestions as to what fields of activity the industrial community will be able to participate in and when. This section will attempt to identify the incentives for investing into the program.

In this context, industry represents those institutions who are able to finance, in some form, the program. These institutions include the utility companies, the contractors and manufacturers and finally the financial institutions and insurance companies. This list is not complete. It could also include the space agencies which are not typically considered to be industrial. They do however, represent the managing aspect of any contract and hence could contribute in that area. This aspect is not covered in this section.

The Utilities

The utilities, currently based on non-sustainable energy sources, will be deeply interested in acquiring a path for gradual change towards a sustainable energy source. As always, they will want assurance that sustainable, reliable solar energy is a practical reality.

An example could be the companies in Saudi Arabia or in Venezuela. These countries are heavily dependent on their oil production and it may be interesting to offer a space solar power program alternative to these existing companies. Oil conglomerates in Saudi Arabia and Venezuela will wish to see how a conversion process from oil to space solar power is both feasible and manageable. Their geographic location, near the equator, will undoubtedly give them a further incentive to investigate this alternative.

Users of coal and other fossil fuels call for a slightly different approach. These supplies are estimated to be at least double the oil supply. Hence, there is less urgency for companies to convert to another source of energy. As an example, China possesses an abundance of coal. Their demands in energy are increasing rapidly. State-owned companies may be very reluctant to switch and hence financial incentives may be needed to compensate for the transition. The alternative is an environmental strategy whereby a world-wide carbon credit system penalizes heavy CO₂ emitting sources and encourages alternative sources. Of course, the trading of credits is permitted in exchange for either technology or possibly space solar power program shares.

The utilities based on sustainable energy sources, such as hydro-electric or nuclear power, are facing increasing opposition by both the environmental groups and, perhaps more importantly, the general public. This apprehension translates to a limited growth opportunity and possibly towards an intolerance for potentially damaging energy sources. It is unclear at the moment if this opposition will be sufficient to convince the utilities to investigate alternative safe forms of sustainable energy.

Contractor and Manufacturers

With regards to the contractors and manufacturers, the first task for the public relations group is to identify the industrial sectors and in particular the companies whose core competencies would complete and complement the overall program. Once established, these companies should be addressed and possibly given an incentive to supply initial equipment for the program in exchange for preferential treatment in the later stages of program development. An alternative to this scheme may be to offer some form of lease arrangement, albeit this scheme has not been fully developed. In addition, these companies would want information as to how to position themselves for future contracts.

Financial Institutions and Insurance Brokers

As unfortunate as it may seem, financial institutions will only provide funding to ventures which are perceived to have little or no risk. Although not as stringent, insurance brokers operate in a similar manner. The program, as it stands, is far beyond the reach of these institutions. Once the program is proven successful, both technically and financially, participation from these institutions will occur.

An analogy to the program, which may prove to be useful, is the deployment of ships in the 16th century towards the new world. North and South America were seen to have unlimited amounts of resources which Europe desperately needed. As soon as the sailing ships were proven to be successful in obtaining this wealth, most financial institutions quickly entered into the venture. In fact, Lloyd's of London was created for the sole purpose of insuring these sailing vessels. Once the program is

proven, Lloyd's would have no difficulty in insuring a product that will generate wealth for the foreseeable future.

Summary

This section has dealt with public relation issues relating to the governments, international organizations and the industrial community. To briefly summarize, governments must receive information on the space solar power program which relates to their national interests. For the developed countries, the reasons for participation may be due to the dwindling of non-sustainable energy sources, the lack of energy self-sufficiency, the cost in protecting existing sources and the increasing opposition to harmful energy sources. For the developing countries, governmental aid diverted to the space solar power program in an equitable distribution scheme will provide the incentives necessary for full participation.

The UN would be an ideal forum for the exchange of ideas at the global level on the distribution of benefits and costs of the project. A possibility would be the creation of a world energy sub-committee, if not in existence already, which would address issues related to space solar power. It seems unlikely at the present moment that the G7 would publicly support the program until the commencement of the large scale solar power satellite program.

Timing is important when promoting the program. The energy crisis of the 1970s, the Persian Gulf war and the environmental disasters such as the oil spill of the Exxon Valdez represent opportune times to present the benefits of the space solar power program and to raise public support.

The utilities, based on non-sustainable energy sources, will be deeply interested in acquiring a path for gradual change towards a sustainable energy source. The utilities, based on sustainable energy sources, are facing increasing opposition. It is unclear at the moment if this opposition will be sufficient to convince the utilities to investigate alternative safe forms of sustainable energy.

Once established, companies who are identified as crucial to the program should be addressed and possibly given an incentive to supply initial equipment for the program in exchange for preferential treatment in the later stages of program development. Finally, the program, as it stands, is far beyond the reach of the financial institutions. Once the program is proven successful, both technically and financially, participation from these institutions will occur.

5.5.2 Coordination with the Scientific Community

The scientific community will have an important role to play in any solar power program. Their support would be a great asset to the program while their opposition would be a major obstacle. The scientific community must be convinced that space power is viable, affordable and safe before lending support.

For any space power realization it is fundamental to have effective collaboration between the research community and industry. People involved in pure research contribute with new ideas and methods, while industrial teams work in order to realize and exploit these innovative concepts. In order to ensure a profitable technological return from space power research a good scientific basis for the development of the project is needed. The research carried out by scientists is the first brick in any space power building. They will do this work cheaply or even free but only if they are really interested. In some cases they are already involved in particular studies related to space power and would be happy to have an opportunity to test their concepts. Scientists are able to identify new problems and areas of possible interest as well as suggesting and carrying out experiments.

As science is one of the justifications for spending money on space programs, it is important that any space program-funded venture have a significant science content. This means that if ISPO expects to attract funding from existing space budgets experiments with real scientific value in a wide range of areas, not all obviously related to the problem of beaming power to Earth, must be performed on any platforms launched.

Another aspect to be considered is that many scientists will worry about possible loss of interest in and funding for fields of research far from space power or for studies of alternative sources of energy. This could create internal struggles within the scientific community which must be avoided if possible. The impact of space power research on the budgets of unrelated areas of science must be minimized.

All areas of science have significant crossovers and areas of common interest. It is likely that large elements of the research necessary for space power realization have already been carried out in unrelated fields. Thus it is important to communicate effectively with a broad range of scientists through recognized scientific channels, and new channels if necessary, to identify these areas and avoid unnecessary effort and spending.

It is part of a scientist's training to consider risks and failure probabilities in a realistic manner. While many people succumb to the temptation to consider only best-case scenarios for, for example, lifetimes of materials and noise levels, the scientists are able to keep a perspective without a vested interest. This relative objectivity is important in realistic assessment of technologies and projecting progress.

Despite the important role the scientific community can have within ISPO it must be noted that its influence over general public is not strong or consistent. This influence depends on the way in which scientists present their ideas and opinions: they should not address only small groups of experts, but rather seek opportunities to communicate with an enlarged public without a specialist education. Only in this case will the scientific community be important in gaining popular support for the program. The negative influence the scientific community can have, on the other hand, is significant. Thus effective communication with those researchers opposed to space power is critical to limit the damage they do to the program in the public eye.

Interfacing with the Scientific Community

The ISPO program, in common with all major research undertakings, requires cooperation and collaboration between university and other research teams in order to allow a better use of the human and technological resources already in place throughout the world. Skilled people need to be brought together with the equipment and facilities necessary to carry out experiments, wherever they may be located.

Research related to space power will be coordinated and driven by an international scientific committee, appointed by the Board of Governors of ISPO. This would be modelled on currently existing scientific assessment committees for national space programs. The committee will consist of a small number of distinguished people with high research profiles. Members of the group will be chosen according to their spontaneous interest in all aspects of space power study and their standing within the research community.

This committee is a point of contact for other scientists interested in space power. They will help to ensure that Space Solar Power is presented in journals accessible to the rest of the community and that data is made available to interested parties.

Within the organization, the committee is the interface between the business side and the scientists. The committee advises the program manager of scientific priorities and large-scale funding requirements for major areas of research. In association with project scientists, it will coordinate the activities of scientists working on space power, without preventing them from carrying out their own research in other areas. To this end it will select experiments consistent with the major scientific objectives for the program and Principal Investigators for these experiments. This will include the many ground-based experiments that must be carried out as well as those onboard satellites. This structure allows individual scientists involved in pure and applied research to contribute to good technological and scientific progress while keeping fundamental independence from purely industrial and business activities.

As the scale of space power research increases, it will become necessary to have more conferences, like SPS '91, dedicated to the study of space power, in order both to gain an external perspective from other scientists attending and to disseminate information on the activities within ISPO to a wider audience. IPSO itself should encourage, support and eventually coordinate these enlarged conferences.

As commercial aspects of space power become more important, the scientific priorities will change. With the exception of independent experiments piggy-backing on the large platforms that commercial space power requires, especially for space to Earth projects, science will play a reduced role. Unless there is a strong incentive, scientists will be less willing to devote their time to the project. As there will be many people who have worked on the program by this stage it should be possible to retain an effective internal scientific group to carry out additional research as it becomes necessary. This will probably consist of post-doctoral students still interested in the challenges of all aspects of the program. In addition, scientists could act as consultants to the organization, as required.

Specific Areas of Scientific Interest

There are many areas in which ISPO needs to be in direct contact with the scientific community, and each must be considered in the light of its unique character. Quite apart from experiments required for feasibility studies of the program itself, there will be a large amount of power available in space for carrying out other experiments during periods when the satellites are not beaming or receiving power.

Atmospheric Physics

Scientists have major concerns in relation to atmospheric physics, particularly the possibility of significant heating of the ionosphere from microwave beaming. As these problems are one of the major technical obstacles to successful large scale solar power beaming projects, ISPO must work closely with scientists in this field. It would be relatively simple to incorporate experiments on board any power beaming tests. In addition to large-scale tests on the ionosphere, local plasma tests should be done, as the characteristics of this medium will affect the performance of the satellite. Compositional analysis of the different layers of the atmosphere could be carried out also.

Effects on Biota

For many years now experiments have been carried out on the effect of irradiating biota [Murakami, 1982]. Unfortunately, many of their results, while suggesting that relatively low microwave intensities have no major effects, are inconclusive and much more work is necessary in this field to prove the safety of long-term exposure to radiation. This work would be difficult within the context of ISPO, as it is not directly related to most of the other technical issues and IPSO's objectivity would be in doubt. However it is critical that this work is done and supported by ISPO as these effects are among the main concerns of the public.

Effects on Electronics

Experiments have shown [Osepchuk, 1986] that the effects of electromagnetic waves are much stronger on electronics than on biota, typically by 2-3 orders of magnitude. Thus if power is going to be beamed to Earth it is critical either that this is shown not to harm computers or other electronic equipment or that economical counter measures be developed.

As this effect is strongly dependent on the thickness and separation of wires in electronic components, there may be strong opposition from manufacturers interested in continually reducing their size. Experiments in this area must be carried out by ISPO.

Interference with Communications and Astronomy

All areas of the radio spectrum are heavily used, and it is critical that any power-beaming equipment be very tightly characterized throughout its lifetime, to ensure that interference problems can be overcome or prevented.

The precise frequencies suggested for use by space power systems are already used by communications equipment worldwide and radio astronomers have very strong objections to any heavy power applications throughout the microwave range, because of the high noise levels associated with industrial-scale use of electromagnetic radiation. Already domestic microwave ovens are a serious problem for observations [Osepchuk, 1991][Anderson, 1979]. Particularly in the area of frequency allocation, these scientists have a very strong influence. This necessitates cooperation where possible. Many manufacturers of communications equipment also work in fields associated with space power, making this easier. Negotiations with astronomers will be much more difficult, however, and must be initiated as early as possible.

Solar Physics

Solar Physics is of interest to space power systems for a number of reasons, as the use of improved solar models could affect the performance of any solar power satellite. The environment in which the satellites will travel is strongly dependent on solar activity, both in terms of occasional bursts of high energy particles and continuous particle and radiation fluxes from the sun. In addition the power collected by the solar cells will be strongly dependent on the optical and near IR output of the sun, and so improved knowledge in this area would be useful. Experiments to monitor solar activity are light, relatively inexpensive and do not require extremely stable environments. For these reasons they ought to be carried by space power satellites.

Materials Development

Most large scale Space Solar Power Program concepts involve masses much larger than could reasonably be launched from Earth. Thus the possibility of materials fabrication on the moon, from asteroids or in orbit must be considered a key enabling technology for space power. This is a field of interest to many scientists, and often has important spin-offs for terrestrial material production. A good example of this type of spin-off is that of concrete manufactured from lunar regolith. [Lin, 1985] The new techniques invented for this task, when applied to terrestrial concrete, yield a higher quality product. [Lin, 1992]

With the increase in scale of ISPO it could work to encourage research into non-terrestrial materials and possibly initiate this research itself.

Power Technologies

The potential for development of power transmission, conversion and retrieval technologies is huge, and some people working in this field would be enthusiastic about working on space power.

Research is needed on the development of, for example, specialized high power, low mass, high efficiency laser systems, currently a very active area of research. If funding were made available with an Solar Space Power Program specification there would be many interested researchers. Other areas like microwave generators and transmitters, receiving technologies and pointing techniques will continue to be of interest.

Some of the power technologies necessary for space power will be specific to the project, and so would have to be funded by ISPO. Other areas, however, could be developed in cooperation with organizations interested in Earth-bound uses. ISPO could lobby grant bodies to make power research a priority.

Budgets - Overall Picture

Scientific budgets are always strained to the limits. Unless ISPO can procure funding independent of the general science budgets, it is important to be sure that there is a real science component in any project that is funded from these sources. As can be seen from the strong opposition from many scientists to the Space Station program, failure to do this can make relations with the scientific community difficult. This is where the committee must work to prove the merits of power beaming and associated scientific experiments.

The alternative strategy is to ensure that space power funds are clearly differentiated from funds allocated to science. This, however, will be extremely difficult in the initial non-commercial stages of the plan.

Budgets - Others Working on Alternative Energy

There are many forms of alternative energy that are much more technologically mature than space power. If government money is channeled to ISPO they are likely to make lots of noise and point to their own not insubstantial achievements. The committee must set out to communicate directly with these groups and get their input at the earliest possible stage. ISPO must make it clear that its goals for space power are realistic, and dissociate itself from implausible ideas for space power utilization. Proving scientific usefulness at each experimental stage is important here to avoid alternative energy scientists giving ISPO, and space power in general, a bad name in the scientific community.

Health of Space Workers

If it is proposed to have people constructing large structures in space, it is vital that medical researchers are assisted in carrying out experiments as to the safety of these workers at the earliest possible stage. Before the atomic bomb tests in the forties, this was not considered and many people at those initial test firings have since died of cancer. Extremely bad publicity of this type must be avoided.

Communications Technologies

Non-military applications of very high accuracy pointing technologies are rare, and many experts in the field of laser and microwave guidance would happily move to the civilian sector if given the

opportunity. There are possible associated uses for beam guidance - airplanes for example - and it should be possible to distribute the funding load for this research over many organizations.

Perception of Science

The perception of research projects, and therefore of all of science and engineering, is a very complex issue. The factors that interest the public are often not important scientifically, but must be addressed. Scientists have had bad experiences with being associated with "big science" before and will therefore be cautious about becoming involved with another "unlimited cheap energy" project, especially after the fiasco with cold fusion. A scientist is known by his work and would most likely avoid over-hyped projects for this reason. The program outlined in this report builds slowly on its successes and so avoids any single "huge leaps for mankind" that could ruin the organization in case of failure.

To illustrate this, consider the cases of the Apollo, Hubble and Space Shuttle programs.

In the 1960s the US invested huge sums of money in a program to send people to the moon. New technologies were developed from scratch for the project. The public only knew about the main factors involved - the basic mission and the success or failure of each part of the mission. As the public saw success, they approved of the project and the huge cost of the project became less important. This made scientists happy. Very happy.

The Hubble Space Telescope was another mega-project, though not on the scale of Apollo. Here the public again expected a "success". The initial problems with the mirror created the impression of a failed mission and, no matter how much work was done to improve the quality of subsequent images, it is consigned in the public's perception as a failure.

The Shuttle, despite accomplishing few of its stated objectives of frequent launch and high scientific and commercial application, is perceived as a successful venture by the public.

This shows how important the level of public knowledge of any project is. Because of the volatility of public opinion, scientists will be very careful about becoming associated with "big science". This is particularly true in these days of shrinking budget.

If the project is defined in terms of its long term goals alone, there must be a long-term financial commitment and good initial feasibility work. For a project driven largely by science it will be easy for scientists to utilize the capabilities of the platforms flown without having to associate themselves with enormous space structures proposed for fifty years in the future. Either way a significant scientific input in space power studies can be assured. Given current funding restrictions it appears as though the scientifically driven alternative is the more realistic.

Conclusions

The prospectus for the near term is quite straightforward. Proving technology and examining atmospheric properties on a small scale will meet with little opposition, and quite a bit of support from those in fields directly related. Good coordination in order to ensure real scientific content and open access to results are also important.

The complex engineering tasks and management structures involved in ISPO could exist without significant scientific input, but this would be to ignore the possibilities for research that these activities offer, at least in the short term. Thus science can be used as a partial justification for ISPO's activities at this stage, and the results of research as a significant part of the payback.

In the longer term ISPO will have a reduced scientific content, and at this stage its funding must be seen to be independent of other scientific budgets and any scientific participation will probably be limited to exploiting the large constructions in space. Experiments related to space power could be carried out within ISPO or with the help of outside scientists acting as consultants to the organization, while others will still be free to suggest independent experiments on the platforms.

5.5.3 General Public

The general public is important to the Space Solar Power Program because the support of the public is vital to the future and funding of such a project. Therefore, we must consider the reactions of the public, and take steps to educate the public about the Space Solar Power Program. We must also formulate policy to guide the educational and informational interactions of the ISPO with the public.

Education

The public learns at a rate similar to that of a child. A child cannot learn everything about a complex subject in just one lesson, he must be taught in measured doses, he must be taught gradually over time. In the case of the Space Solar Power Program, educating the public is extremely important. If the public is to accept and support the Program, then it must have an understanding of what it is, how it will work, and what its benefits, and potential problems, may be. But if we are to educate the public about the Space Solar Power Program then we must start now. The public should be involved from the beginning of the project, by teaching it about the problems in the world energy supply, environment, the social contrast between "rich and poor" societies, and the alternative futures for our planet. We must also teach the public about possible solutions to these problems, with an emphasis on how the Program might fit into such solutions.

Through such education, the public will be able to gain an awareness of how the Space Solar Power Program will benefit them directly. Later, as the first project milestones are reached, we must further educate the public about these achievements and about future milestones. In this way, the public will realize that the Space Solar Power Program is feasible, useful, and that it is worthwhile to spend money on it. In this phase, the public will be very important supporting the project by convincing financiers and governments to seriously undertake to realize all the project goals. At the final stages of it, the public will have a proper knowledge about most of the important aspects related with space solar power and about what is necessary to make it work. By that time, we hope that the public will fully understand and support the Space Solar Power Program.

In educating about it, we have to deal with a huge group of people with differing backgrounds. Our audience will differ in education, social condition, and demographics (people living in America and Europe have different cultural position and possible concerns from people living in Africa or some Asiatic regions, for example). Since the Space Solar Power Program is intended to be useful — if not necessary — for all of them, we need to think about a suitable way to educate all these various groups. It is important to supply people with accurate and understandable information about the project. Our task should be to single out different groups within the public and address them with the proper information for their backgrounds by the proper means. This should be done in order to let them be able to judge our project in an appropriate way and possibly to support it as well.

We can suggest, both for people who already have a good cultural background, and for those who are able to attend schools at any level, some sort of technical and scientific education. It will be provided in the usual school systems and among special interest groups. For people without appropriate background or for people who are unable to join any kind of scholastic system, the best education will be provided by our answering the questions which are commonly associated with the idea of a Space Solar Power Program. However the same questions are worthwhile being answered for the rest of the public, even those with higher education, because most of us will have the same basic concerns about it.

For these reasons we will detail some general concerns. For a more thorough scientific and technical preparation it would be useful to look at some of the references presented in this report.

General Concerns

In order to present the Space Solar Power Program to the general public it is useful to think about the possible concerns the public will have. The public will ask questions about very different aspects of the project and we should always be able to answer in a simple but at the same time appropriate manner. Some of the most likely concerns are related to the economic aspects of the project and to what extent the individual citizen will contribute and benefit.

At a first glance the idea of solar power from space could seem crazy or at least another game for scientists and engineers to play with. Above all there seems to be more important things to think about in this moment: lack of fundamental condition of survival in many of the Third and Fourth World countries, people without work in many of the developed countries, and the high level of pollution all over the world, just to present some examples. Why should we think about a Space Solar Power Program now instead of after solving these problems? Let's deal with two fundamental reasons. By improving the energy supply in both developed and developing countries we will be better able to face most of the problems which are stressing humanity. At the same time we do not want to leave our children and grandchildren with the burden of a damaged world. We would like to leave to them the tools and the opportunities to live and grow, exploiting the potentialities of every country. A dignified standard of life for as many people as possible means less opportunities for wars

and a step towards a real world society. In order to prepare a better framework to the future generations we need to begin working now.

The process will be slow, step by step, because as far as any meaningful change is concerned it needs to be studied, prepared, tested and gradually applied. At the beginning it will probably cost some sacrifices to all of us: we could be requested to contribute through a percentage of our taxes to the financing, study, and realization of the Program. This is nowadays applied in some of the industrialized countries for the development of alternative sources of energy. The Space Solar Power Program will be able to supply clean energy to people all over the world: if everyone contributes according to how much he can, it will be a small individual sacrifice with a huge global result. It should be clear that the Space Solar Power Program is realized for the public benefit. It will be necessary to have a return for people who invested in its realization. This return will come in the form of profits and jobs in the industries which invest in the Program, and in terms of clean, less-expensive, easily accessible energy for the public. In third and fourth world nations, even a small amount of such energy can make a very big difference. And in the long-term, there will also be the added value of the environmental improvements which will result from the realization of the Space Solar Power Program. It will not wholly solve the energy problems of future generations but it will be very important in helping to produce a high quality life for most of the people on the Earth.

But beyond environmental concerns, there are even deeper issues. For instance, at the present moment, a better standard of living is much more important to the majority of the people on Earth than environmental concerns. In developing countries the paramount driver is feeding one's family and improving the conditions of life, even if there must be environmental damage in the process. How can we raise the standard of living? Reducing energy use overall is not an option — the least-developed industrial nations use only one hundredth as much as the most developed but they suffer a living standard one hundred times lower in consequence. Do we want to stop our global progress and to reduce our every day demands? Can we afford to globally reduce energy use without condemning the majority of the world population to a low standard of living?

We would like to generate energy cheaply, reliably, without significant environmental impact and without lowering the standard of living on Earth. How can we do that? Let's examine some of the most well-known possible future way of producing energy.

Nuclear power: it is not cheap enough for most developing nations, and there will be a huge number of reactors by the middle of the next century with an increase of the probability of fatal accidents, even if the safety systems are improved.

Solar power at ground level: for having energy in the amount needed it will be necessary paving most of the world with solar cells and the efficiency of the system strongly depends on the different geographical areas; as far as the actual technical knowledge is concerned, we are not able to say if it will be really cheap.

Fusion power: at the present moment we are still far from the realization of the condition for a commercial exploitation of the energy by fusion which we are able to produce in the laboratory. Even if we do, it will be extremely expensive to produce. In any case, the problem of radioactivity is still open.

Power from the ocean: this project is actually under study; there are concerns because the process of obtaining power from the temperature difference between surface and deep ocean water could change global climate by altering the heat balance at the ocean's surface.

Conventional suggestions — those suggestions linked to the Earth surface — do not offer very good solutions. But the idea of solar power from space allows us to change perspective in facing the problem and probably to find better answers to our several requests. There is a large reservoir of energy in space of different kinds and forms. We can think of collecting part of it for our activities in space and on the Earth. Even in a narrow band and at the distance where a satellite can maintain a fixed orbit, there is solar energy enough to supply more than the demands of energy for the Earth of the 2050.

But how can we catch and deliver some or all of this energy? The base concept is simple. It is necessary to locate in geostationary orbit a satellite with large arrays of solar panels. These convert solar energy to electricity which is then converted into microwaves (for example) of appropriate wavelength. The microwave energy is beamed down to an Earth-based receiving station, converted back to electricity and fed to a power distribution grid. In this way we will potentially be able to

deliver energy everywhere it is necessary, above all in developing countries which will trade risky conventional sources of energy for cleaner, cheaper energy from space.

We should be ready to properly answer to concerns related to the environmental effects involved by the Space Solar Power Program: to explain if it can be dangerous to beam power to the Earth in the microwaves range, to say clearly that a laser or microwave beaming system will be used only for power transmission from space (and not for military purposes), to specify according to which criteria the site of the rectenna will be chosen, to give a realistic idea of the conditions of working and living in space during the construction of the system and its operation and maintenance. Other concerns could arise about the ownership of the Program, who controls the switch, if it may be used as a weapon by some terrorist groups, how long the system will last before it needs to be replaced, etc. We should be able to stress that the Space Solar Power Program is an international project and every country that is involved in its realization will have a part of responsibility as well as a part of profit in it.

Educational Policy

In order to succeed in educating the public, the IPSO will need a well-designed educational policy and a plan for implementing it. We believe that a main feature of this policy will be that education, as opposed to public relations, should be concerned not with convincing the public of something, but rather with giving the public the information it needs to make its own decisions. Therefore, the educational policy of the Space Solar Power Program ought to take care to provide all the necessary factual information of relevance to it, even if such information is not always favorable towards space solar power. For example, if there are dangers associated with the Space Solar Power Program and power beaming, then the public needs to know about them, and about how such dangers might be prevented or limited.

Another important feature of our educational policy is that all people on Earth who might be directly affected by the space solar power, and especially those who will be living near rectenna sites, ought to have the opportunity to learn about the Space Solar Power Program. The ISPO must assume the financial responsibility for such educational tasks.

In order to ensure a consistent level of education about the Space Solar Power Program, the ISPO should do the following things:

- (1) Start an Education Office in the Space Solar Power Program to coordinate public education.
- (2) Produce educational materials about the Space Solar Power Program in the form of videos and pamphlets.
- (3) Train a team to travel around and educate school teachers about the Space Solar Power Program.
- (4) Fund public television documentaries about the Space Solar Power Program.
- (5) Provide assistance in the development of advanced curricula about the Space Solar Power Program.

We should also note that particular kinds of educational materials will be appropriate for particular audiences. We must make sure to produce a complete range of materials for different levels of schooling and according to the different nationalities and cultures. We should also make sure that our advanced materials provide information targeted to the concerns of the various technical and special interest groups that will want to learn about the Space Solar Power Program to a deeper level of understanding. Finally, we must take special care to produce educational materials about how the space solar power might help resolve some of our environmental problems, and target these materials to environmental groups.

As to the nature of the specific content of the Space Solar Power Program educational materials, this report is not the proper place in which to present a developed curriculum. However, we would like to point out some of those concepts which must be included in such a curriculum when it is formulated. The following list is intended to summarize some of these concepts, from more general issues to more specific ones:

The Sun

- How does the sun make energy
- How much energy does the sun produce
- How long will the sun last
- How is solar energy collected

Ecology and energy

- Closed system
- Pollution
- Greenhouse effect
- Acid rain
- Ozone layer
- Energy budget
- Limited resources
- Unsustainable versus renewable energy
- Alternative energies
- Carbon credits
- Energy grid
- Energy economics

Space power

- Solar power
- Solar cell
- Satellite

Power beaming

- Electromagnetic field: spectrum, wavelength, frequency, energy
- Microwaves / laser
- Rectenna
- Space to ground
- Space to space
- Ground to space
- Power levels

Telerobotics for construction

- Space construction
- Telepresence
- Robot

Biological effects of EM fields

- Microwave and laser energy
- Sensitivity of human body to EM fields
- Environmental effects of Space Solar Power Program
- Counter measures and precautions

Interference of EM fields

- Effects on electronics
- Effects on communications systems
- Counter measures and precautions

Space Solar Power Program

- Vision of the Space Solar Power Program
- History of the Space Solar Power Program
- Economics of the Space Solar Power Program
- International venture
- International cooperation
- Schedule of the Space Solar Power Program
- Project milestones

Presentations

Besides scholastic, media, and written forms of education, there is also the opportunity to educate people through special presentations on the Space Solar Power Program. In this direction, particular attention needs to be paid to methods of communicating with the public. First of all we have to remember that generally people have no particular interest in the Space Solar Power Program—it is our task to create this interest. The presentation of the project has to be neither boring nor patronizing. One of the most proven techniques in this regard is to send IPSO speakers to appropriate social events of large public attraction; they can present the most significant features of the importance of the Space Solar Power Program. Multidisciplinary conferences and workshops are good ways to communicate more specialistic issues about it; these will be addressed to that part of the public which has a higher level of education but not necessarily a scientific or technical background. They will be prepared keeping in mind that an architect or the biologist will have a different approach to the subject than an engineer or a physicist. The goal of these events is to help the general public to critically and competently deal with the Space Solar Power Program debate. We would like to have an informed, and not a merely emotional, response to the initiative for solar power from space.

Image and Information Policy

The Image of the Space Solar Power Program is a vital factor in the survival and funding of the organization. Externally, the public image of the Program can make or break the organization because it has the key element to gaining public approval. Internally, it needs a well-defined corporate identity as a way of maintaining morale, inspiring dedication and loyalty, and unifying the members of the organization.

Image Policy

The public image of the Space Solar Power Program has to be carefully engineered. This must be done by coordinating the visions and work of the public relations team and the top management of the organization, and lower level organization members. It is vital that a consistent image be defined and communicated internally to the entire organization so that it will be reflected in the external communications of the Space Solar Power Program from all levels within the organization.

Because of the high potential for criticism from environmentally-minded special interest groups who oppose microwave beaming for various reasons, it is important to construct a pro-environment image for the Space Solar Power Program. This image should position it as an attempt to help save the environment, not merely as a profit-making venture. Indeed, the profitability of the Space Solar Power Program should be de-emphasized to avoid creating an image of a greedy organization willing to endanger the health and safety of the masses in order to make a profit. Instead of emphasizing profit, it should emphasize break-even. This has the added benefit of heading off criticism that it will be a money pit.

The Space Solar Power Program should seek to build an inspiring profile. This can be done through public relations literature/presentations/video which emphasizes the innovation, grand scale, future vision, and new frontiers introduced by the Space Solar Power Program. It is also important to convey a sense of historical purpose, the public should come away with a sense of how and where the Space Solar Power Program fits into the current and future social, technological, ecological, and political environments.

The Space Solar Power Program should choose an effective logo and attractive yet functional formats for organizational stationery. The colors and design aesthetic should convey the orientation of the organization; for example, consider earthy colors and rounded geometries for an environmentally-minded appearance, and on the other hand, primary colors or grays, and angular geometries for a high-power corporate appearance. It would be a good idea to print organizational literature on recycled paper that includes the standard logo/note to this effect.

Establishing a strong and effective public image is a dynamic process. In the early stages, much of the work is done through presentations and literature. Later on however, it is mostly done through the media. At this stage of the game, image must be actively maintained and supported through an iterative adaptive process. As criticisms and threats appear, they must be analyzed and responded to as quickly as possible. If a criticism is not met with a response, it is regarded as true by those who witness it and also by those who originated it. Such a situation has to be anticipated and defended against.

Corporate Identity

Corporate identity is important both internally and externally to an organization. A healthy and well-defined corporate identity serves to unify and motivate employees. This in turn, is eventually reflected in the nature of the organization's interactions with other organizations and with the general public as well. It also helps to individuate and highlight an organization in its environment.

Creating an effective corporate identity is partly the responsibility of the public relations team and partly the responsibility of the management team. The PR. team has to make sure that the level of internal awareness and education regarding the Space Solar Power Program is at least as good as that on the outside. Furthermore, as the organization grows it will become important to start an internal publication to inform the employees and friends of the Program about relevant events. The management team has to take steps to ensure a healthy, supportive atmosphere within the organization, an atmosphere with its own special "corporate culture." Establishing various corporate traditions, rewards, enjoyable activities, good benefit packages, and a well-implemented feedback system, are all effective tools for evolving the kind of "corporate culture" we would like to see in the ISPO. We should seek to ensure that interactions between various levels in the organizational hierarchy are as non-confrontational and non-intimidating as is possible. Above all, it is vital that the organization be characterized by an atmosphere of trust, recognition for hard work, and cooperation.

In general, the corporate identity of the ISPO will set the tone for the future evolution of the organization. This tone will have a profound effect on the intellectual and social environments within the organization. The corporate identity of the ISPO will effect the kinds of ideas that are suggested and accepted within the organization, the kinds of people who are hired and fired, and the behavior of the organization towards its employees, it's partners, and the general public. In this way, it should be evident that the corporate identity of the ISPO will be directly influential on the Space Solar Power Program. If the corporate culture is conservative and intimidating, then it is likely that the Program will turn out to be conservative and intimidating. If the ISPO corporate culture is innovative, open-minded, and socially aware, then it is likely that the Program will have these same characteristics. We suggest that in engineering the ISPO corporate culture, careful attention is given to those general qualities which the organization would like to see in the final Space Solar Power Program. Once these qualities have been determined, a corporate culture which also has these qualities should then be defined.

Information Policy

The information policy of the ISPO needs to be clearly defined. An ineffective information policy can lead to conflicts within the organization and when interfacing with the public, the scientific and political communities, and the media.

There have been numerous examples of large technological projects with ineffective information policies. Mainly, this has been due to information flow problems. The Biosphere 2 project is a good case study for how things can go wrong in a scientific venture when the flow of information is mismanaged. The Space Biosphere Ventures corporation chose to implement a closed information policy due to the proprietary nature of its technology, however, this policy aroused the suspicion and indignation of the scientific community. Furthermore, the Biosphere management chose to delay reports of problems with the project, a practice which further aroused distrust. Although the problem is now being corrected, the damage done by this policy is slow to heal, and many members of the scientific community still feel disapproval towards the project.

Clearly, the Space Solar Power Program is vulnerable to similar problems to those experienced by Space Biosphere Ventures, Inc. and steps must be taken to make sure that they do not materialize. This can be done by maintaining an information policy that is as open as is possible within legal limits. Access to all information about the organization and the project should be allowed and assisted wherever possible. In the case of confidential information, sanitized versions of the information should be created. In general, if information is missing or restricted, then people think something is being hidden. In some cases, such as proprietary technical specifications, and some financial and legal documents, it is acceptable that access to information will be restricted, but in many other cases, such as scheduling, safety and environmental considerations, status of projects, experimental results, etc., access to information ought to be invited and encouraged.

Another important consideration is the flow of information. The Space Solar Power Program needs to have a central information clearinghouse, such as a public relations office, to coordinate both the internal and external release of information about the organization and its work. In general, information should flow from the bottom up and should be iteratively evaluated via this clearinghouse

prior to external release. One important role for the central information clearinghouse is to manage crisis situations should they develop. It might be advisable for the Space Solar Power Program to retain a crisis management consulting firm in case of a serious and large-scale crisis, such as a disaster during space construction, or a satellite falling out of orbit.

Finally, in our information policy, we should take care to avoid the mistake, made by many space agencies, of creating dangerously high expectations in the mind of the public. We must be careful not to over-inform the public. In general, it is wise to publicize a project in such a manner that expectations are very conservative and humble. That way if things go well, it will seem as if the project performed even better than expected, and if things go badly, the project will not seem to be a total failure. Our enthusiasm should be tempered by a realistic outlook—the public relations team of the organization should project a well-balanced image that brings about well-balanced expectations.

Media Relations

The media is the primary channel through which the Space Solar Power Program will interface with the public. Therefore, it is important to operate according to a well-defined media relations policy. Of particular concern to this policy is the journalism community, for initially it will be the opinion of this community that forms the public's "first impression" of the Space Solar Power Program. Every effort should be taken to produce clear, frank, and concise public relations material which is specifically aimed at providing a balanced portrayal of the Space Solar Power Program to media representatives. Such materials ought to present a top-level view of the project and the organization, a technical summary of the Program in easy to understand language, a summary of the positive aspects of it, and a set of convincing responses to likely criticisms of it. The purpose of this last section will be to refute any potential criticisms that reporters might conceive of. The idea here is to think ahead, to answer criticisms before they are made into mass-media issues, and thus "take the wind out of their sails." It is much easier to stop a criticism before it is published than after.

As well as avoiding a negative portrayal in the press, we should also take steps to bring about a positive portrayal. To do this, we ought to follow standard procedures for impressing press representatives. For instance, facility tours, press-releases, invitations to all important events such as conferences and announcements, high-level interviews whenever possible, and a very accommodating and cooperative full time press relations staff should be provided to the press by the ISPO. In addition, it would be wise to cultivate long-term relationships with individual reporters and press-representatives so as to be able to educate them to a high level of knowledge about the project.

When the press visits, make sure to log the affiliation, names of the reporters, and the publication/broadcast time of each report. Have a press representative witness the report if possible, and request a copy of the report once it is available for archival purposes from the press while they are present. It is also a good idea to provide a standardized database to the Space Solar Power Program press representatives with which to rate press reports according to their favorability of the project. Later, this database can be utilized to specially invite favorable reporters to important events, and to send them press releases etc.

The press should be held accountable for its mistakes. If and when mistakes are made that could harm the position of the Space Solar Power Program in the public eye, a response must be made and a high-level complaint should be lodged with the offending press organization. This should ensure that a correction and apology will be made. If necessary, legal action should be threatened in extreme cases of irresponsibility on the part of the press. It is important to take an active role when dealing with the press so that reporters realize that they need to be especially thorough in checking their facts when covering the Space Solar Power Program.

When interfacing with the media there are various considerations specific to particular domains:

Television

When working with television crews, realize that their time is extremely limited and often they beam their reports in live or on short advance for news broadcasts. Therefore, be ready in advance to host television crews with representatives. Furthermore, it is important to prepare members of the ISPO for television visits, as a shabby mode of dress, inappropriate behavior, or a careless intrusion into live location shoot can be embarrassing to the organization. If classified material or objects exist near a video shoot site, it is necessary to limit the access of the press, since they tend to film whatever they think looks interesting without asking. Never allow a television crew to roam a facility unattended, always provide a knowledgeable liaison. Also note that once an image is on tape, it is almost

impossible, even using legal means, to convince the press not to use it, especially if they find it interesting.

Radio

Radio interviews must be carefully arranged so as to take place in an area with low environmental noise. It is also important to choose a press representative with a good speaking voice and a relaxed speaking manner, since clarity is important on radio broadcasts.

Public Networks

Public networks such as public television and radio are special cases and require special treatment. Often they operate on lower budgets than private networks, and this should be taken into account. Furthermore, they tend to side with environmental activism and anti-establishment perspectives. It is therefore important to stress the environmental benefits of the Space Solar Power Program and to emphasize the overall social and political ideals of its vision. In doing this, we may position the Space Solar Power Program favorably in the public media and thus win the approval of their audience. This particular audience is one of the major sources of potential resistance to the Space Solar Power Program, and their support is therefore of extreme importance to the survival of it.

Print

The print media should be provided with in-depth information resources about the Space Solar Power Program. As well as all relevant, non-classified inside literature on the project, they should also be provided with references to outside information.

References

Anderson B. et al, Spurious Radiation from Microwave Ovens, Nature, 282, pp 594-596, 1979

Lin, T.D., Concrete for Lunar Base Construction, Lunar Bases and Space Activities of the 21st Century, Lunar and Planetary Institute, 1985

Lin, T.D., private communication, 1992

Murakami, A., DENJIHA NO SEITAI KOUKA, DENPAKENKYUJO KIHO, 28, p689-714, 1982

Osepchuk, J., Environmental Issues for the SPS, Space Power, Vol 6, pp. 165-173, 1986

Osepchuk, J., Microwave Oven Noise Considerations and the Probability of Interference with Communications Systems Operating in the ISM band: 2.40-2.50 GHz, Raytheon Company, 1991

For different altitudes in the Earth's atmosphere different effects become dominant.

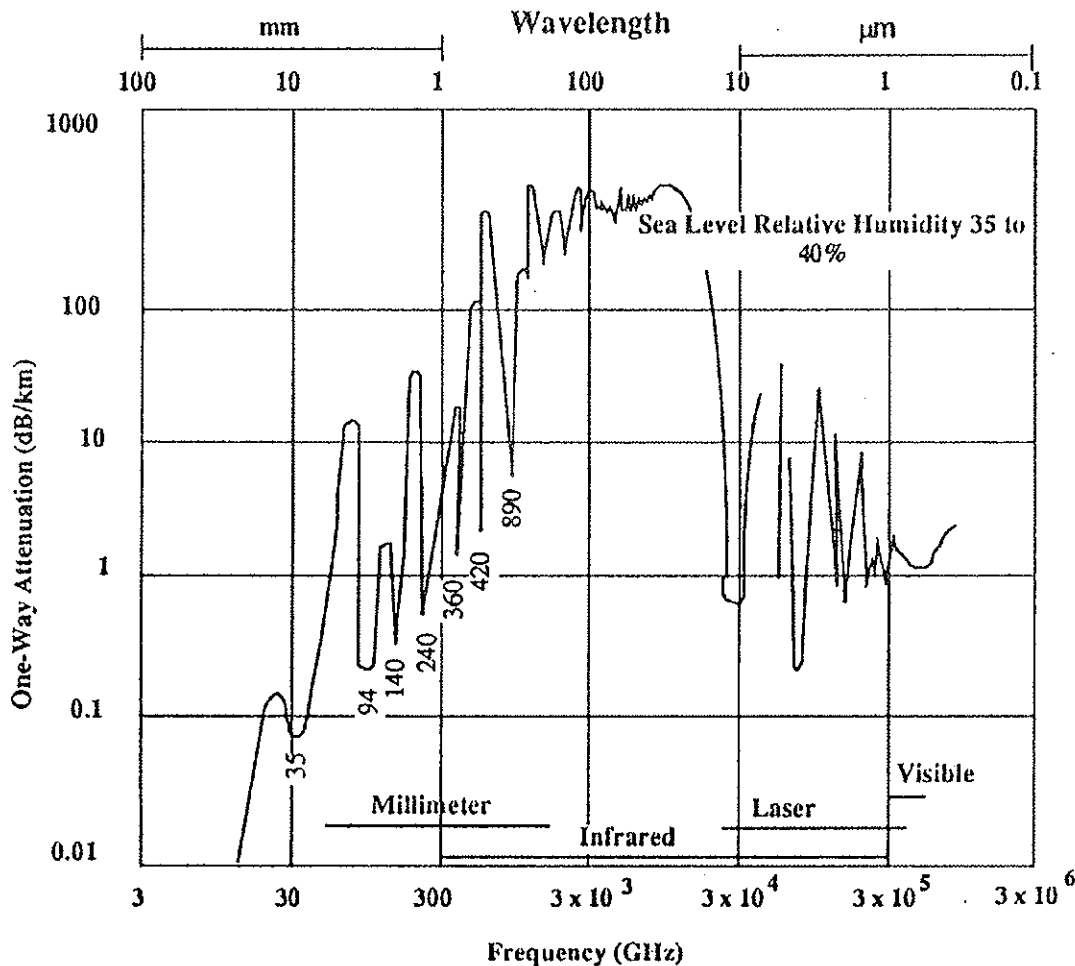

Figure 6.1 Atmospheric Attenuation versus Frequency at Sea-Level for Horizontal Propagation

Interactions with the Ionosphere

Due to the low densities of molecules in the ionosphere molecular absorption losses and scattering effects are negligibly small. Therefore the ionosphere-beam interaction can be divided into two general categories: resistive (ohmic) heating effects and self-focusing instabilities. Ohmic heating is given by the following expression (Duncan and Gordon, 1977):

$$Q = \frac{E_o^2 f_p^2}{8\pi f_o^2} (v_{ei} + v_{en}) \quad (\text{Formula 6.1})$$

where Q is the volume heat source, E_o is the peak electric field amplitude, f_o is the radio wave operating frequency, f_p is the plasma frequency, and v_{ei} and v_{en} are the electron-ion and electron-neutral momentum transfer collision frequencies, respectively. As one can recognize, the ohmic heating is directly proportional to the inverse square of the radio wave frequency, therefore the ohmic heating decreases from 2.45 GHz to 35 GHz by a factor of about 200. Theories predict that effects like thermal runaway (Perkins et al., 1977) and self focusing (Duncan, 1977) might occur at power densities of 200 W/m² and more at 2.45 GHz. (This will be slightly exceeded by a 5 GW power plant in GEO.) On the other side, experiments that have been conducted at the Arecibo radio telescope (Duncan et al., 1977) in order to investigate the effect of a 5 GW microwave beam at 2.45 GHz on the ionosphere showed no changes in electron density and temperature. Experiments have been

6 Environmental and Safety Issues

In this chapter we report the work that was done mainly in order to investigate the impacts on the Earth's environment caused by space solar power beaming. We begin by examining the effects directly caused by the power beam (e.g. microwave or laser beam). Next we discuss the impacts that the construction of a large artificial structure in orbit will have on the environment and on the safety of the workers. Our discussion would be incomplete without the treatment of the problems related to the existence and operation of a large receiving rectifying antenna. Furthermore in the security and maintenance section, we will state our overall assessment of the Space Solar Power Program. Finally we will address one section of our chapter to the planning and scheduling of the stages that have to be performed before the implementation of a large solar power satellite. In this chapter we mainly deal with a large solar power satellite in geostationary orbit as proposed by the study of National Aeronautics and Space Administration (NASA) / Department of Energy (DOE) in the late seventies, however specific research concerning the design examples that are treated in Chapter 10 was done and will be found in the corresponding chapter. It is important that planners of any size space solar power station, do a very careful environmental impact study.

6.1 Effects of Transmission of Energy

6.1.1 Propagation of the Beam through the Atmosphere

In this section we will address the questions connected to the interactions that the power beam can cause within the atmosphere, including the ionosphere. For our work we refer to a solar power satellite in geostationary orbit that will beam power in the 5 GW range to the Earth's surface as was proposed by the NASA/DOE study of the late seventies. As the main attenuation of the power beam is caused by the atmosphere, we concentrate only on a few frequencies, given by a minimum in atmospheric attenuation according to Figure 6.1. [Koert et al., 1991].

As one can see in the figure below, there are several frequency-bands, where the attenuation is low (less than 1 dB/km). According to availability of technology, we choose the frequencies listed in Table 6.1 [Koert et al., 1991 and Firmain 1991] for further investigations.

Table 6.1 Frequencies to be Investigated in More Detail and Available Technologies

Frequency /Wavelength	Source Type	Performance
2.45 GHz/ 122 mm	Gyrotrons, Klystrons	1 MW CW
35 GHz/ 8.6 mm	Gyrotrons	200 kW CW
94 GHz/ 3.2 mm	Gyro-Traveling Wave Tube	100 kW CW
140 GHz/ 2.14 mm	Gyrotron	400 kW CW
ca. 30 THz/ 10 - 11 μ m	CO ₂ -Laser	1 MW CW
60 THz/ 5 μ m	CO-Laser	CW
133 THz/ 2.25 μ m	to be investigated	to be investigated
ca. 500 THz/ 0.4 - 0.8 μ m	Free Electron Laser	to be investigated, CW

Upon transmission of electromagnetic radiation through the atmosphere and ionosphere the following effects may occur:

- Ohmic heating,
- Thermal self-focusing instabilities,
- Molecular absorption losses,
- Scattering.

conducted at lower frequencies than 2.45 GHz in order to achieve the same ionospheric heating with lower power densities according to the law mentioned above. However, the results are not final and we recommend the construction of a radio wave heater at the desired transmission frequency that will exceed the heating of a 5 GW radio wave power beam.

The laser-plasma interactions in the ionosphere at a wavelength range of 5 - 10 μm were investigated by Beverly (1979). He found the effects to be negligible. However no experiments were conducted.

Effects on the Lower Atmosphere

The dominant effects upon transmission of electromagnetic radiation through the lower atmosphere are molecular absorption and scattering.

Molecular absorption for frequencies below 3 GHz is nearly constant (about 0.7%) and independent of the atmospheric water content. The losses due to scattering below 3 GHz are tolerable and do not exceed 4% in the worst case (heavy thunder storm). For frequencies above 3 GHz the absorption increases and depends strongly on the water content in the atmosphere due to the pressure broadened absorption line of water near 22 GHz and a Oxygen absorption line near 60 GHz. For medium humidity the power loss at 35 GHz is about 5% (Manson, 1976). Rain (5 mm/h, 10 km path length) can increase the loss considerably (see also Figure 6.2). [Manson, 1976]

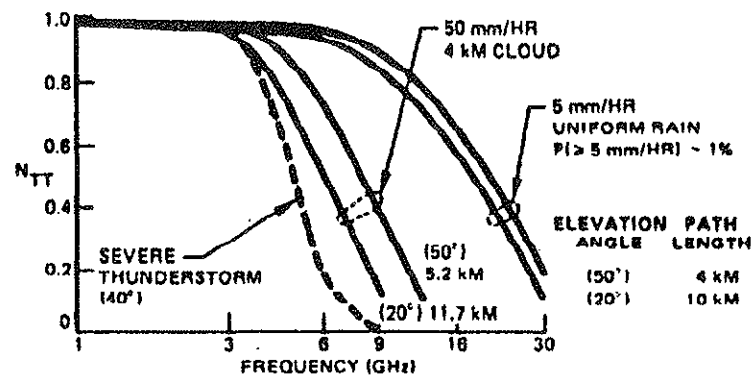

Figure 6.2 Transmission Efficiency - Molecular Absorption and Rain

Therefore we recommend not to use frequencies higher than 3 GHz in areas with high probability of rain, snow, hail or thunderstorm. However, frequencies above 3 GHz (especially 35 GHz) can still be used in very dry areas as deserts.

For laser-transmission the analysis is more difficult because there is a complex absorption structure in the atmosphere for the Near infrared (NIR)-wavelength. range with many transmission- 'windows'. A detailed study was conducted for line-selected CO-laser by Beverly (1979). We shortly summarize the results of this study here. It was found that for the selected wavelength (5.078 μm and 5.068 μm) the atmospheric loss is strongly dependent upon weather-conditions and season. For 50° latitude the transmission varies between 70% and 95%. The study concludes that global climate changes are highly improbable, however local climate changes can occur and turbulences may be produced which could be hazardous to intruding aircraft. The perturbations of the plasma chemistry in the mesosphere and thermosphere is believed to be not significant. However this is not confirmed and further research is necessary. Serious environmental modifications (e.g. depletion of the ozone-concentration) is proclaimed not to be possible.

Power Leakage at Rectenna Site

For a 5 GW beam, 2.45 GHz space power satellite at GEO, the heat release at the rectenna site over an area of 120 km² (40° latitude) will be in the between of 6.5 W/m² and 9.5 W/m² (estimated efficiency, Lee, 1978). This has to be compared with the net flux of all radiation at the surface of 75 W/m². Thus, the perturbation of the average surface heat exchange is of the order of 10%. The estimated man-made heat dissipation in the city of Cincinnati in 1971 was 25 W/m². This means that

changes in the local climate can not be excluded. Therefore the perturbation caused by the rectenna is comparable with the one caused by a large city. We recommend to conduct or review studies of existing cases where the perturbation induced are the same as for a 120 km² rectenna.

For higher frequencies the power density will be increased compared to 2.45 GHz and can therefore reach the same order as the natural net flux of radiation. In this case changes in the local climate are highly probable but will affect a smaller area as the rectenna size decreases with frequency.

For laser transmission the power will be concentrated on a much smaller area than for microwave transmission. The heating of the receptor site can reach the same order as for a conventional large thermal power plant. The effects caused by the heating shall be compared with the ones of already existing power plants.

Recommendations and Conclusions

The studies conducted so far show no major environmental impacts in the case of the beaming of 5 GW from geostationary Earth orbit (GEO) to the Earth's surface at a frequency of 2.45 GHz, we can therefore recommend this frequency for general application in the field of power-beaming. For frequencies higher than 3 GHz the presence of water in the atmosphere causes a significant increase in the absorption and scattering of the radiation, therefore we recommend the use of 35 GHz only in very arid areas like deserts. The discussion for wavelength in the NIR-range is more complicated as the absorption-versus-frequency relation is more complex than in the microwave-range. There exist several narrow windows, but their application for power beaming depends on the availability of a suited laser-system. So far few studies on the effect of laser-beaming on the environment have been conducted.

For further research we recommend the following steps:

- Continue the theoretical work on the impact of microwave-beaming on the ionospheric plasma.
- Build up a radio-wave heater for the ionosphere in the power range of a few GW, and investigate the impacts by backscatter radars.
- Conduct detailed studies on the meteorological and climatic impacts of microwave and laser-beaming in the lower atmosphere region.

6.1.2 Electromagnetic Effects on Biota

The only practical way for space solar power stations to get the energy they collect to Earth is via power beaming. The two primary means of power beaming under consideration today are lasers and microwaves. Both methods can potentially cause damage to the animals and plants around the receiving station. This section addresses a few of the potential problems. Designers of future power receiving stations will have to look carefully at these problems and find ways to mitigate any negative effects.

Considerations for Laser Beam Usage

The Effect of Laser Beam on Animal Retina and Iris

The animal organ that is most sensitive to a laser beam is the retina. A laser beam which is coherent and parallel easily makes a small heat injury called a "Black Spot" on the retina. If a laser beam is weak enough so that it makes no injury on the retina, the beam will never be harmful to any kind of living organism.

The location of the beaming satellite can be considered as an infinite distance in comparison with the size of an animal eye ball and the laser beam can be regarded as a parallel ray. Therefore in the worst case, when an animal eye focuses on an infinite distance and is illuminated with the beam, a light spot whose diameter is around its wave length will be made on the retina. Here we show the absorbency of a retina according to the wave length of the laser beam [Inaba et al. Laser handbook, Asakura Shoten, Tokyo, Japan].

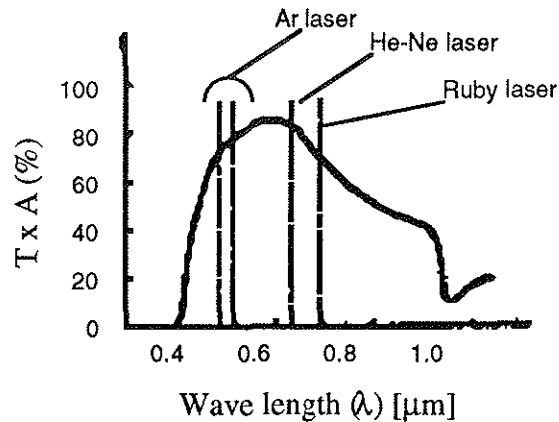

Figure 6.3 Absorbency of retina according to wavelength. Absorbency expressed by the following formula; Eye ball passage rate (T) x Retinal absorption rate (A)

All of the light energy that has passed the iris concentrates on the small spot. If the energy density in the spot is higher than the threshold, it will make a "black spot" injury there.

The property of a retinal injury is different depending on the type of the laser beam, pulse or continuous. Here we suppose that this system will use a continuous laser beam but one power transmission duration will be less than 24 hours.

ACGIH standard (USA, 1968) requires protection of the human retina against continuous laser illumination stronger than 2.4×10^{-5} [W/cm²]. American National Standards Institute (ANSI) standard (USA, 1976) says nothing about laser energy density on the human retina. It deals only with the illumination on the cornea, based on real pathological examples. Its requirements are;

For continuous laser beaming on a cornea which is less than 3×10^4 sec in duration,

$0.4 = < \lambda = < 0.55$ [mm]:	Maximum power density on cornea is 10^{-6} [W/cm ²]
$0.55 = < \lambda = < 0.70$ [mm]:	Maximum power density on cornea is $10^{(0.015(\lambda - 0.55))} \times 10^{-6}$ [W/cm ²]

These limitations were defined as 1/10 of the intensity which causes eye injury with 50% probability. As there is no possibility that a human looks continuously at the beaming satellite on orbit for more than 3×10^4 seconds, this requirement is also applicable for the habitants in rectenna site.

An estimation of the maximum allowable laser beam power density based on ACGIH standard is as following:

Assumptions:

- "90% of laser beam energy through an iris will be absorbed in the retina, based on Figure 6.3, including safety margin.
- The maximum iris aperture diameter is 7 mm in humans. But it should be considered to be at least 10 mm for other animals; for example, nocturnal animals like cats, owls and so on.
- The heat spot size on the retina is around 1.5 mm, three times the wave length.

Estimation

- Power density from the beaming satellite: P [W/cm²]

$$\frac{0.9P \text{ [W/cm}^2\text{]} \times (1.0 \text{ [cm]})^2 \times \pi}{(1.5 \times 10^{-4} \text{ [cm]})^2 \times \pi} \leq 2.4 \times 10^{-5} \text{ [W/cm}^2\text{]}$$

Above derive:

$$P \leq 6.0 \times 10^{-13} \text{ [W/cm}^2\text{]}$$

This limitation is far more critical than the ANSI standard. It is because this assumption ignores many physiological and physical parameters such as the beam scattering in the eye and the nystagmus. Therefore, the ANSI standard based on epidemiological and pathological data is more practical in this case.

Under a condition based on the ANSI standard, a laser beam must be expanded to less than about 10^{-3} [mW/cm^2] on the ground. Then, 10 MW power transmission requires at least 10^3 [km^2]. Though this size of receiver is almost the same as the predicted size of the rectenna which will receive microwaves of comparable power, this light receiver must not have any slit or hole nor any obstacles in it. Therefore, this time, the existence of so large a receiver (more than 30 [km] x 30 [km]) will cause ecological problems, because it will affect the local climates in some aspects such as humidity, wind speed, local reflection rate of solar light, and so on.

The Thermal Effect of the Laser Beam

On average, the human body surface emits 100 W energy over time. In case of exposure to the laser beam from the beaming satellite, if he or she is naked, the person's body receives the beam only on half of the body surface, which bears 50 W of daily heat emission.

The energy of visible light is absorbed mainly in the skin surface. This is the most different feature of laser beams in comparison to microwaves.

The peak power production of the human body is around 1 kW but its duration is not long. Therefore, human skin can tolerate heating up to 10 times of the internal heat production, for a while. In this case, half the body surface receives 500 W radiation and estimating the body cross section area as 0.3 m^2 , the allowable radiation density is :

$$500 [\text{W}]/0.3 [\text{m}^2] = 0.17 [\text{W}/\text{cm}^2].$$

This is about 1.4 times the solar constant and is tolerable to the human body in short duration. The use of protection suits to reflect visible light is recommended for humans. But of course, no animal can use their eye under the laser radiation of this power because even the scattering light is harmful to their retina. However, the area of the receiver can be reduced to several square kilometers.

Conclusion and Advice about the Usage of Laser Beam

If we want to avoid any kind of biological hazard caused by misdirection of beaming, the power density should be less than 10^{-6} [W/cm^2] to prevent damage on animal retina in the case of misdirection of the laser beam. In this case, the size of the receiver becomes so large that it should be divided into small pieces scattered over large area on the Earth to avoid ecological effects.

If it is possible to ignore the effects on unprotected animal eyes, we can use a much stronger beam (up to 10^{-1} [W/cm^2]). This time, we must consider the possibility of local biome change caused by the additional heating, up to the solar constant power. And the misdirecting of the beam onto animals will cause the loss of visual ability in a large part of the visual field and decrease the survival rate of the animal (including humans). The decrease or increase of some kinds of insects will also affect the plant composition in the area. The excess heat effect changing the local biome depends on the efficiency of the receiver.

Energy Emission in and from the Rectenna Site

Whether the energy from the power satellite is conveyed on the Earth by laser or microwaves, all the additional energy which has failed to be converted at the receiver or the rectenna is exhausted as heat into the atmosphere. At the highest level, this effect can be classified into the following three groups.

- 1) If the amount of excess energy is small enough, there is no effect on biota.
- 2) If it is not strong enough to perish the whole of the ecosystem, new biota which is adapted to the existence of the beam will emerge.
- 3) If it is strong enough, complete death of the ecological system in the area will occur.

One of the problems of the energy transportation system design is which condition among the three above should be selected. The answer will be different depending on the scale of the total system of the rectenna site. If it is an experimental or preliminary system which can be done in a small

laboratory room or field less than 1000 m², the use of the number 3 condition can be permitted. But, in case of the situation where many rectennas or receivers are used all over the Earth, it is difficult to control all of the ecological systems being fluctuated by the existence of many rectenna sites, even under the condition number 2). We can not decide now.

In a case where we can apply the condition 3), biota is not a concern. All we have to consider is the heat effect on local and/or global climate.

In case of ii), we must, and may be able to, predict the resulted new ecological system according to the amount of the excess heat. For example;

Desert ---> More sterile desert

Plain ---> Desert

Temperate zone ---> Desert, Plain or Subtropical zone (depending on the humidity supply)

Antarctic (inner land)-> Emergence and development of any kind of ecological system supported by the heat of the beam.

Antarctic (shore line)-> Destruction and modification of the peculiar biota there.

And in this case, we should consider the direct heating of living organisms by the laser beam or the microwaves, as much as possible, too.

In case of condition 1) using microwave power transmission, all we have to consider is the direct non-thermal effects of microwave on living organisms.

Consequently, the condition 2) is the most important issue in consideration of the excess heat effect on biota.

A General Aspect on the Usage of the Microwave Beam

Unlike laser beam, microwave effects are not restricted to the skin surface. The depth of the effects depends on its wavelength.

The effects can concentrate in a wavelength-specific part of animal and plant bodies because of the resonance between the body and microwave. For example, microwaves of 2.45 GHz have a resonance with a body whose thickness is around 6, 12 or 18 cm.

The major effect of microwaves on animal bodies is thermal, but some reports say there are some non-thermal biological effects of microwave.

Human Protection Standard Against Microwave

The USA and former USSR have their own microwave safety standards and they are referred to by many other countries. We summarize them in Table 6.2. [Murakami, 1982]

As you can see in Table 6.2, the safety standards against microwave radiation on the human body is 10³ times different between the USA and former USSR. In the USA, only the thermal effect is considered and the temporary biological effect which will disappear after the irradiation period is not regarded as a problem which should be removed. However the non-thermal direct microwave effects on living organisms is considered in USSR.

In the ANSI(1979) standards of USA, the limit 5[mW/cm²] for more than 0.1 hour, is determined as ten times (safety margin) the "2 x heat emission" from a common human body surface. The mechanism for normal heat transportation from internal organ to body surface is not considered. Also, it should be noted that microwave effects are not restricted to body surface.

**Table 6.2 Microwave Safety Standards in the USA,
Former USSR and Canada**

Country	allowable power density	frequency	duration
USA (ANSI 1979)	100[mW/cm ²]	0.3 MHz-3 MHz	> 0.1 hour
	900/(f ²)[mW/cm ²]	3 MHz-30 MHz	> 0.1 hour
	1.0[mW/cm ²]	30 MHz-300 MHz	> 0.1 hour
	f/300[mW/cm ²]	300 MHz-1.5 GHz	> 0.1 hour
	5[mW/cm ²]	1.5 GHz-100 GHz	> 0.1 hour
(Maximum heat production by microwave radiation must be less than 1440[J/kgbw/hour])			
(ANSI 1973)	30[mW/cm ²]	10 MHz-100 GHz	2 min. in any 6 min.
USSR(1965)	10[μW/cm ²]	300 MHz-	continuous
	100[μW/cm ²]	300 MHz-	2 H/day
	1[mW/cm ²]	300 MHz-	20 min./day
Canada (1976)			
for common people	1[mW/cm ²]	10 MHz-300 GHz	continuous
for occupational	1[mW/cm ²]	10 MHz-1 GHz	continuous
	5[mW/cm ²]	1 GHz-300 GHz	continuous
	25[mW/cm ²]	10 MHz-300 GHz	< 1 min.

Thermal Effect of Microwaves

There has been much reported about thermal microwave effects on the human body using numerical analysis on ideal models [Tell, R.A., 1972].

As an example, here we show one of those results based on the multi-layer human tissue model.

1) < 150 MHz

Living tissue is almost transparent to this electromagnetic wave.

2) 150 MHz-1 GHz

Penetration depth into animal tissue is more than 2 cm. For those large animals like human, most of the energy is converted to heat in deep part of its body. The small animals suffer fewer effects than large animals.

3) 1 GHz-3 GHz

This kind of electromagnetic wave is absorbed in the tissue 1-2 cm, 3-4 cm and 5-6 cm depth. There appears to be a periodic absorption peak depending on the wavelength and the property of the skin. The tissues with a high concentration of water absorb the microwave energy well. As the bone works as a reflector of the electromagnetic wave, the water rich tissue near to bone is easily heated.

4) 3 GHz<

Most of the energy is converted to heat at the body surface, i.e., at the skin. As the wavelength shortens, its effects show more resemblance to the effects of the infrared beam and the visible laser beam.

As the microwaves of number 3) or 4) has the highest possibility to be used in the power transmission system at present stage, we must be careful of their properties.

Effects upon Whole Body Irradiation

The ability of electromagnetic modeling of an animal body is very restricted because of its extreme complexity. If you intend to model the whole of an animal body, you must deal not only with its physical structure but also with the intrinsic protective and compensatory reaction mechanisms in the body. However, it is impossible at the present stage. Therefore we should observe the real effects of microwaves on real living organisms. Unfortunately, there are few reports using a microwaves of more than 10 GHz frequency.

Lethal effects of microwave on animals has been intensively studied as a candidate for weapon use during the last world war. Here is an example of those experiments [Fly, et al., 1964].

Subject	A dog, unknown in detail
Microwave frequency	2.8 GHz
Microwave intensity	165[mW/cm ²] (33 times larger than ANSI standard)
Result	
0 min.	Microwave irradiation start
Until 30 min.	Rectum temperatures increase 1.0-1.5 degree (called "phase 1")
Until 90 min.	Rectum temperature is constant around 40.5-41.0 degree (called "phase 2")
After 90 min.	Sudden increase of rectum temperature and animal death (called "phase 3")

It is considered that the body temperature control system equilibrates to the heat injection by the microwave during phase 2, and phase 3 shows the consequence of the sudden destruction of the body temperature control center in the brain.

Eyes

Among the animal body tissues, the lens and the testis are most sensitive to excess heat. Both of them have difficulty in being cooled by blood flow because of their relatively scarce blood vessel distribution.

Examples about the damage causing threshold (both for irradiation duration and power density of microwave) on the eye (lens), the testis, and the whole body of the dog is shown in Figure 6.4 [Ningen-Kankyousei ed. group, 1972] In this figure, 3 GHz microwave is used. The damage in the lens is mainly heat induced partial death of cells or protein destruction, i.e., a cataract.

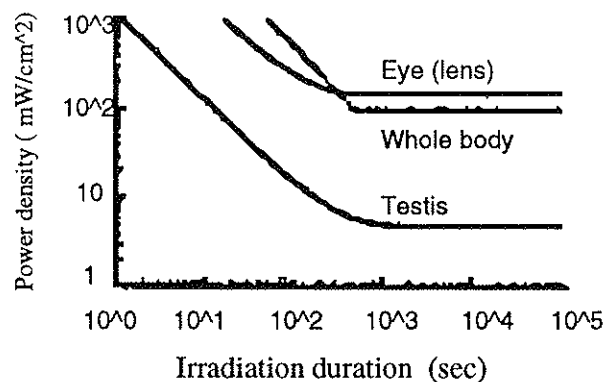

Figure 6.4 Relation between Microwave Irradiation Duration and Power Density on the Threshold to Cause Damage in Dog Eye, Testis and Whole Body (f=3 GHz)

Results using rabbits whose eye has a similar structure to humans are shown in Figure 6.5. In this Figure 2.45 GHz microwave is used. This is not so different from results using dog. [Information directorate, Department of National Health and Welfare, Canada, 1977, 1978]

Those results correspond well to theoretical numerical analysis of the eye ball and they show that the temperature threshold to cause cataracts in any part of the lens is 41°C. There is no report of cataract caused by irradiation of electromagnetic wave less than 0.5 GHz. It is reported that microwaves more than 100 GHz heat the cornea rather than lens.

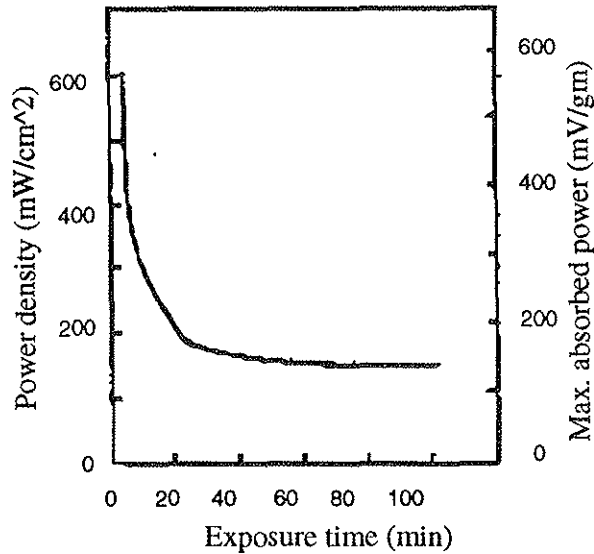

Figure 6.5 Relation Between Microwave Irradiation duration and Power Density on the Threshold to Cause Cataract on Rabbit ($f=2.45$ GHz)

Testis

The following thermal effects (damage) of microwaves on testes are well known. [O'Connor, M. E., 1980 / Michaelson, S. M., 1980]

- Degeneration of epidermal cell layer of the spermovessel
- Marked decrease of the matured spermatocytes

Sensory Organ

Table 6.3 Threshold of the Microwave Intensity and Exposure Time for Human Thermal Sensation (at 3 GHz)

Exposure time	Power density
1 sec	58.6[mW/cm ²]
2 sec	46.0[mW/cm ²]
4 sec	33.5[mW/cm ²]

From the Figure 6.4, the threshold for dog testis damage is 5[mW/cm²] for long exposure to microwaves of 3 GHz. This intensity and duration is the same value as the critical line defined by the ANSI standards for human. There are some reports which claim the existence of microwave effects in development, such as, deformation of embryonic tail, anatomical disordering of brain and increase of death rate of embryos. However, this has not been studied in detail.

Table 6.4 Threshold of the Microwave Intensity and Exposure Time for Human Pain Sensation (at 3 GHz)

Exposure time	Power density
20 sec	3100[mW/cm ²]
30 sec	2500[mW/cm ²]
60 sec	1800[mW/cm ²]
120 sec	1000[mW/cm ²]
>180 sec	830[mW/cm ²]

Humans can sense microwave thermal effect as a sensation of heat or pain. As shown in Table 6.3 [Michaelson, 1972], humans are sensitive enough to detect microwaves as a sensation of warmth. But it is difficult to discriminate the cause of the sensation using only the sensation itself. Also in the

sensation of pain caused by the microwave, the 1000[mW/cm²] irradiation requires as long as 2 minutes to induce pain as shown in Table 6.4 [Michaelson, 1972]. In this case, the shallow skin temperature (1.5 mm depth) is calculated to be 46 °C when the human notices the abnormal stimulus. This temperature is high enough to create heat injury in skin. Therefore the intrinsic sensing system in the human body can not be used for the microwave alarm.

Auditory Organ

Some reports say that a microwave pulse of 0.1[mW/cm²] causes a sensation of click sounds to a human. [Michaelson, S. M., 1980 / Lin, J. C., 1980] Now it is known that the sound is the result of small and quick thermal swelling in internal organs in human body, especially organs in the skull, such as the brain.

Cardiovascular System

It is well known that there is an increase of cardiovascular system activity to compensate for the body temperature increase caused by the microwave. No direct effect of microwaves on this system has been found. [Michaelson, S. M., 1980 / Lerner, E. J., 1980]

Neuroendocrine System

Some studies have been done on the reaction of the endocrine system to microwaves of intensity which are able to cause thermal effects on tissues. Their results show a concentration change in many kinds of hormones under microwaves irradiation. However, all of them are explained as a part of feedback reaction caused by the hypothalamic body temperature control center under thermal stimuli. [Michaelson, S. M., 1980 / Lu, S. T., Lotz, W. G., Michaelson, S. M., 1980]

Bone Marrow

There are many reports on this subject. It may be because of the ease of this kind of experiment. In most of the reports, the discrimination between effects of microwaves and effects of heat are insufficient, and many results conflict with each other. Therefore we can say that there is no definite knowledge on this subject. [Michaelson, S. M., 1980]

Nervous System

Research on the thermal effects of microwaves on the nervous system is very limited and more work needs to be done.

Non-Thermal Effects of Microwaves

Since 1950's, in the former Eastern block countries, it has been widely accepted that there is another kind of biological effect of microwaves which appear without any thermal effects (heating) on tissue. It is now uniquely called "non-thermal effects". The microwave intensity to cause non-thermal effects are in general too weak to induce thermal heating in any tissue. Table 6.5 [Murakami.,1982] lists major reported non-thermal effects.

Table 6.5 Major Non-Thermal Microwave-Effects Reported

Frequency	Intensity	Effects
100 MHz	1[mW/cm ²]	EEG interference
	100-1000[μW/cm ²]	Biochemical effects
3 GHz	1[mW/cm ²]	Behavioral changes
	1[mW/cm ²]	Biochemical effects

But as some of the results conflict with each other, most of the non-thermal effects are now regarded as a "Cheshire cat effect" which means that those effects can be seen only by those who want to see them. Here, we show some reported non-thermal effects as example.

Nervous System

The function of the brain and nerves in animals are based on electro-chemical mechanisms. Therefore it is a fascinating idea that microwaves can directly affect on a brain without any thermal effect. Presently there are no confirmed result about non-thermal microwave effect on brain though it is already clarified that animals have some sensitivity to electric and/or magnetic fields. For example [Lerner, E. J. et al.]:

- Circadian rhythm of animals extends about 20 minutes in an environment shielded against the natural electro-magnetic field of the Earth. The reason is explained to be the interaction between the brain wave and the natural electro-magnetic field which has peak frequencies at 7.8, 14.1, 20.3, 26.4, and 32.5 Hz in its power distribution.
- Another experiment says that an application of an electric field fluctuation of 10 Hz and of 0.1 mV shortened human circadian cycle.
- One hundred and forty seven MHz and 1 mW/cm² electro-magnetic wave modulated by 6-10 Hz was applied on cat and chicken. Modulation of EEG was observed in the cat and increases of Calcium ion flux from neurons were found in the chicken.
- A report says that irradiation of microwaves of pulse 0.2 mW at 1.2 GHz or continuous 2.4 mW/cm² at 1.2 GHz can cause a temporary increase in permeability of blood brain barrier.
- 2.45 GHz and 1 mW/cm² microwave (pulse or continuous) decreases Na-dependent choline uptake in rat brain. The affected part of the brain is different depending on the type of the microwave. [Lai, H., et al., 1987]

Therefore, we can say, at least, the following things.

- Animal brain has some relations with the electromagnetic environment of the Earth.
- The microwaves may affect an animal brain via its effects on the electromagnetic environment.
- The effect of long term microwave irradiation on animal brain is still unknown.

Animal Behavior

There are many reports on this subject, i.e., non-thermal microwave effect on animal behavior. They use the key behaviors of animals such as discrimination ability, motion, avoidance reaction and so on, as parameters of the animal behavior. However, because of the difficulty in quantitative analysis of animal behavior, and because of the difficulty to discriminate thermal effects from non-thermal effects in animal behavior, this is still unclear.

Others

Here we introduce many clear and unclear results on the non-thermal microwave effect. Most of them are still unclear but the mass of these studies seems to indicate an existence of something which has not yet been discovered. From the view point of environmental/safety analysis, we can not ignore the possibility of the non-thermal effects.

- Microwaves of 2.1 GHz, 5 mW/cm² and 3 h/day x 3 months caused decrease of peripheral T-lymphocyte count in rabbit. But there was no concomitant functional impairment of these cells as evidenced by functional assays. [Nagesuvari, et al., 1991]
- Pulsed microwaves of 1 mW/cm² was observed to modify the behavioral effects produced by a drug chlordiazepoxide, widely used as a minor tranquilizer [Yeande].
- Simultaneous dosage of an anticholinesterase drug and 10 mW/cm² at 2.8 GHz microwaves irradiation causes a slight body temperature decline which can not be observed under dosage of only one of them [Asani, et al., 1980]
- Irradiation of a microwave 10 mW/cm², 1.0 GHz depressed DNA synthesis in a kind of leukemia cell [Chang, et al., 1980].

Conclusions and Advice about Electromagnetic Effects for the Biota

From the view point of living organisms, the following items are recommended for the space solar power program designing.

1) In the case of usage of visible laser beam for power transmission, there are three options for power density of the beam.

- If there are any possibilities for animals (including human) to be irradiated directly by the beam, the beam power density should be less than 10^{-6} W/cm² to protect their eyes against retinal injury.
- If eye injury of animals (including human) can be neglected, and if the existence of humans in the receiver site is precisely controlled, laser beams up to 10^{-1} W/cm² can be used. In this case, the local change of the ecological system should be considered. Depending on the consideration, total artificial sterilization of the receiver area may be required.
- If the existence of any kind of living organism in the receiver site is forbidden, the beam power will be limited by environmental aspects other than biological issues.

2) In case of microwave beam usage, the following conditions are advised:

- In the area where uncontrolled long term existence of animals including human is predicted, the microwave beam power density should be less than 0.5 mW/cm² according to the ANSI standard. Other thermal and non-thermal effects shown in preceding sections.
- Human entry to the area where the power density can be more than 1 mW/cm² should be controlled
- Animal entry, especially human entry, to the area where the power density is more than 10 mW/cm² should be forbidden, except for monitored occupational persons.
- The ecological system at the rectenna site should be monitored precisely. And if the new born ecological systems are harmful to other area, some countermeasures, including the total sterilization of the site, should be discussed and executed.
- These electromagnetic effects are also the same for the workers on orbit. Even more, as they are irradiated by much more cosmic radiation than on the ground, more critical restrictions should be applied on the space workers.

3) For more detailed investigation about biological aspects of the beaming environmental effects, the following research and experiments are recommended.

- Short and long term microwave exposure test on plants. It should be done both in the individual plant level and small ecological system level. We must gather the data about the microwave effects on plants at first because there are few reports on this subject as shown in above. This study will require two years for individual plants in short term and up to ten years for small model ecological systems. The latter should be continued also after the construction of the whole system to support the study of the biome in and around the rectenna site.
 - Prediction of the new ecological system which may be borne by the excess heat at the rectenna site and prediction of its effects. It will require one to two years to gather the existing ecological data and to make the prediction.
 - Basic experiments on the electromagnetic effects on living organisms and ecological systems using the frequency whose effects on biome have not been studied. For example, there is almost no research about the interrelation between the microwave of 35 GHz and living organisms. If we use 35 GHz for the power transmission, we must carry out all of the basic biological experiments described above in this section again in the new frequency. It will take only up to two years for such rather simple experiments, but other experiments, such as long time low power density exposure, will take more than ten years using small model biomes. They must be continued even after the construction of the whole system to predict the environmental and ecological evolution of the region in and around the rectenna.
 - Continuous epidemiological data collection on living organisms, especially human, in and around the rectenna site. This activity must be started before the starting of the beaming and must be continued as long as it works. Decades later after the construction, the data accumulated will tell us precisely about the effects of long term microwave exposure on the biome, biota, and individual living organisms.
-

Other Considerations

Epidemiological Studies

Two studies of microwave irradiated population have statistically shown no effect of low power microwave on the rate of death, disease and health (US Navy soldiers irradiated continuously by radar and staff in the American embassy in Moscow).

The epidemiological study is effective in studying the effect of low power microwave. But in many cases, it is difficult to identify the detailed condition such as irradiation level and duration. [Information directorate, Department of National Health and Welfare, Canada, 1978 / Silverman, 1980]

Electromagnetic Effects on Biota of the Antarctic Continent

If the power were beamed to the Antarctic Continent, as suggested in a demonstration, the environmental impacts specific to that location should be considered.

The inner part of the Antarctic Continent is said to be the most sterilized land on the Earth though there are various biota and eccentric biome on the shore line around it. Therefore, we have two subject to be considered on the usage of the Antarctic Continent for the rectenna site. One is the preservation of the ecological system on the shore line, the other is the preservation of the sterility of the inner continent.

The biome on the shore line of the Antarctic Continent is composed of many unique living organisms which have evolved to adapt to the low temperature of the region. For them, even a slight additional energy input such as excess heat flow from the rectenna site may be destructive. Therefore, large scale rectenna facilities should not be constructed near the shore line of the Antarctic Continent.

There is no biological problem in the inner part of the Antarctic Continent if we consider only the existing biome. But we must notice the possibility that the existence of spilling of energy from the rectenna site may create a new biome there. Even one short period of high temperature (as warm as the shore line region) per year is enough to create an ecological system composed of blue green algae and molds. And there is at least one reason to preserve the sterility of the inner region. Because of the sterility, the Antarctic Continent is now a treasure house of biologically unpolluted scientific specimens such as meteorites, ancient rock samples, and ancient air trapped in the ice. In some research, the organic pollution caused by the biological activity is very serious. Therefore, large scale rectenna facilities which can make the partial climate as warm as the shore area should not be constructed in the inner part of the Antarctic Continent.

6.1.3 Interference with Electronic Devices

As we know, electromagnetic waves bring with them electric and magnetic fields, and these fields can of course affect electrical devices. The mechanisms that are involved when a microwave interferes with electronic devices are varied and complex.

An obvious way interference can occur is when a receiver antenna is operating in the same frequency band as the microwave, the microwave will dominate the output from the antenna network. Communication signals are usually of very low power. A power beam would represent many orders of magnitude larger signal than a communication signal. Even a small percentage power refraction from a power beam can represent a blackout for a low powered communication system. This kind of interference can occur at low power levels.

At higher power levels other mechanisms can occur. TV and radio that operates in at frequencies many megahertz from the beam frequency can also be affected. [Juroshek & Steele, 1981] Microwaves can interfere through the chassis and be a source of noise in RF sensitive circuits like mixers, IF amplifiers and detectors. Laboratory tests of TV's have been done in GHz microwave fields, and antenna interference is in this case secondary.

High power interference like this (typically occur at interference levels above 10^{-3} mW/cm²) can also make trouble for other devices. Cardiac pacemakers have been known to be susceptible to high level microwaves, and are prime subjects for a study of compatibility with the solar power satellite power beam. Manufacturers have worked to harden such devices against those sources of electromagnetic interference (EMI) that users might encounter, so their susceptibility thresholds are increasing

because of design improvements. At ultra high frequencies the thresholds for many pacemakers are now in the range of kilovolts per meter [Osepchuck, 92].

Also other medical electronics have to consider the interference threat. The permissible interference levels for electronic medical devices, in USA, according to MDC-E1609 [McDonnell Douglas Astronautics Company Report E-1609] are given in Figure 6.6. Other standards might be found in other countries.

The given figure only gives the limit up to 1 GHz. The power beam that will be considered for a solar space power program will be in a higher frequency, but it would be possible to give a sensible extrapolation from the figure. The susceptibility of electronic devices generally decreases with increasing frequency.

Interaction between microwave energy and integrated circuits can occur in various ways. An important mechanism is believed to be rectification by the various pn junctions. This rectification can inhibit or induce state changes or change the quiescent operating point of a device. An other mechanism is that leads that are connected to the device, can function as an antenna. Test of unshielded integrated circuits, 7400 Transistor transistor logic (TTL) and 4011 Complementary metal oxide semiconductor (CMOS) which have the same function, have shown CMOS to be most susceptible to microwaves at 2.45 GHz. Interference was coupled directly into input, output, and power leads of the integrated circuits [Davis & al, 1981]. Estimated interference threshold for 2.45 GHz was for 7400 14.5 mW and for 4011 6.7 mW. Small malfunctions can make changes in memory, or program errors can occur. If the interference gets much higher, even physical damage can occur. As the development goes towards more and faster transistors on the chips, the transistors gets smaller and leads thinner. Less energy is then needed to cause damage. But protection networks on the connections have become common. The coupling between a power beam and an IC is treated in a report [Ditton, 1975] which examines the coupling of microwaves into shielded and unshielded wires connected to ICs. The development also goes towards better shielding, as more and more electronic devices are introduced to our lives, and the shielding is also for reducing radiation out of the device.

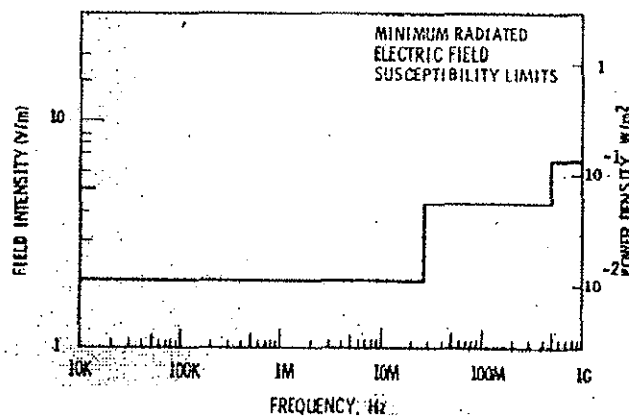

Figure 6.6 USA Standard for Permissible Interference Levels for Electronic Medical Devices

The only place we expect the microwave beam to interfere with commercial digital circuits is within the main lobe of the power beam. Equipment that is needed for pointing the beam could be given special shielding, so the problem is if something by accident should come into the beam. If we assume that the beam direction is stable flying objects, like aircraft's are our greatest concern. The metal skin of aircraft's will function as a shield against electromagnetic waves. Some noise might, however, come in through apertures like windows. Microwaves that hit the aircraft, but do not penetrate it, will be reflected, and can cause interference other places. For these reasons air traffic should be forbidden in the beam, and a suitable security zone around.

Facilities that can be very sensitive to radio noise are radio astronomy installations. Studies of faint and distant objects would be very difficult with harmful interference. Definitions of harmful

interference to these services have been developed by the International Radio Consultative Committee (CCIR) [Davis et al.]. Harmful spectral flux densities have been established as reasonable and measurable quantities. At an area surrounding the National Radio Astronomy Observatory in Green Bank, West Virginia, USA, a National Radio Quiet Zone has been established. Within this area it is intended to only allow radio transmitters with lower power fluxes than 10^{-17}W/m^2 . A fractionally small portion of power not collected by the rectenna could here make problems. Also thermal emissions from large warm satellites may have an effect.

In addition to radio interference, a large satellite would also reflect sunlight, and be a bright object in the sky, and in that way introduce noise to optical astronomy.

6.2 Satellite Construction Effects

6.2.1 Launch Support Industry Effects

To construct Solar Power Satellites on orbit, a number of heavy lift launch vehicles (HLLV) will be required. Therefore, industrial activities in space business will have to increase in a high rate. It will result in an expansion of launch vehicle manufacturer's factories and increase of worker's employment opportunity. One assumption has been made on the amount of HLLV to construct one Solar Power Satellite which according to NASA/DOE would have been made sixty in number. [Iwamoto and Sagawa, 1982]. From this report, you need ten launches of HLLV every day. If we assume that one launch complex will be able to launch a HLLV every 10 day (even this frequency would be difficult to be realized), construction of 100 launch centers would be necessary. Unlike the other industrial or social activities of mankind, i.e., automobile manufacturers, shipbuilders, chemical industries etc., the influence of such facilities on the near by area would be tremendous. We will show one rude calculation. Thrust power HLLV will be 500 times as H1 rocket. Reasonably thinking, the area of HLLV launch complex must be 500 times large as Tanegashima, the world smallest launch center. In addition, to avoid the disasters of launch failure, the complexes have to be located by the beach or in the desert. Therefore, to obtain the land suitable for the construction of the complex must be greatly hard. Moreover, enormous compensatory cost for fishermen would be inevitable. In conclusion, such a plan is unrealistic from the view point of launch support industry effects.

6.2.2 Launch Effects

Effects on the Atmosphere

The development of a large scale space solar satellite project will necessitate a considerable number of launches. In the case of a solar power satellite using only terrestrial material, this number might be in the hundreds of launches of the heavy lift launch vehicle (HLLV) per year for many years. The use of lunar material might reduce the number considerably, but it will remain quite high due to the development of lunar facilities. As the global impact of launches on the environment might be comparable in magnitude to the effect of beaming, its effects on the atmosphere must be assessed.

The effect of a single launch of a present day launcher is fairly well known and somewhat negligible on the global scale. On the other hand, the effects of frequent launches has consequences which are quite difficult to assess, due not only to unknowns in the technology that will be used, but also to the scale change and to the various interactions and feedbacks that this scale change will bring to light.

The most detailed study on this subject to date has been prepared in 1979 and 1980 by the Argonne National Laboratory for the American Department of Energy (DOE) as well as for NASA. This study was based on the Satellite power system point design, but can easily be generalized to any large scale space solar power design. According to the study, effluents from the Earth-space transportation system should be the major cause of solar power satellite related atmospheric effects. It is noted that the tremendous increase in scale as well as the basic lack of understanding of the physical processes involved renders the results as only tentative. Nonetheless, this study is fairly consistent with the "Proceedings of the workshop on the modification of the upper atmosphere by satellite power system propulsion effluents" held at La Jolla in 1979, by the report "Environment impacts of the satellite power system on the middle atmosphere" prepared by NASA in 1980, and by the paper "Effects of rockets exhaust products in the thermosphere and ionosphere" [Zinn, Sutherland, 1980]. The major conclusions are:

Launches might influence the weather significantly on for short periods and on a small-scale, but are not expected to have any major large scale weather effects.

The air quality is not expected to change noticeably, except for a slight increase in nitrogen dioxide. This increase might also cause a very slight and short lasting increase in the acidity of precipitation.

The injection of carbon dioxide in the stratosphere is expected to be too small to cause any modification to the greenhouse effect.

The injection of water in the stratosphere is expected to be too small to have any effects on the ozone layer, while the production of nitric oxide during re-entry of the second stage of rockets should cause a slight increase in the ozone density.

In the mesosphere, water vapor should increase by a few percents at low altitude and by as much as a factor of 100 or more at high altitudes. This will cause an increase in the upward flux of hydrogen from the mesosphere to the thermosphere, which might then cause either an increase in the density in the thermosphere (by accumulation of hydrogen) or an increase in the escape rate of hydrogen. As noted in the "report of the workshop on the modification of the upper atmosphere by satellite power system (SPS) propulsion effluents", the general humidity enhancement of the mesosphere might produce long-lasting contrails which might disturb remote sensing from satellites, while the potential hydrogen concentration enhancement in the thermosphere would increase the drag on low altitude satellites.

For various reasons, the plasma densities in the ionosphere might change. Due to the variety of effects involved, the sign of the change in the different layers is hard to assess, except in the F-region, where it is expected to decrease substantially. This decrease would perturb wave propagation and might also increase airglow. On the other hand, the NASA study previously mentioned expects the perturbation of wave propagation to be minimal.

Effects on the magnetosphere are not well understood but cause concern since injected amounts of material and energy are large compared to natural occurring values. Possible effects include increased airglow, artificial currents similar to those caused by magnetic storms which would induce currents in power and telephone lines as well as plasma instabilities which would cause communication interferences.

No corridor effect (changes in concentration of major constituents in a narrow latitude zone centered on the launch point) are to be expected.

Effects on the Ocean

Launches are responsible for water pollution because NO_x is included in the rocket exhaust. Two main aspects must be considered.

- the question of local, intermittent effects associated with individual launches
- the question of regional, long-term contributions representing cumulative effects over the entire period of high-rocket-launch activity

According to DOE's report of "Environmental Assessment for the Satellite Power System-Concept Development and Evaluation Program-Atmospheric Effects" published at Nov. 1980, the short term pH of rain will change to value ranging from 4.6 to 4.2 owing to HLLV launch.

On the other hand, long-term effects owing to nearly 400 HLLV launches per year is negligible because of the change of the pH value is 0.07 and it would not be detectable.

An increase of water acidity might also be caused by the possible acidification of precipitation. As we have mentioned above, the HLLV launch center must be located by the beach. Therefore, a great deal of exhaust pollution would drop into the sea near the center. The cumulative effect of the pollutant must not be ignored. Moreover, there would be the possibility that the pollutant destroy the ecosystem in the sea..

Potential Launch Failure

As the number of launches increase, the number of failures will also increase. The effects of launch failure will be similar to those of aircraft's accidents during take off and landing. Therefore a very important issue is the selection of launch site. A sufficient distance should be kept from the densely habituated regions. If the average rate of launch failure is 5%, which is lower than the present

state, there will be one launch failure every two day when you want to launch 10 HLLVs per day. Total weight of HLLV would be 8,000 ton with 450 ton of payload on LEO. Can you imagine such situations?

Pollution Effect on Biota

Air Pollution

The main effects of many launches from Solar Satellite Power Program to biota are related to air pollution, thermal dissipation, and noise. Air pollution caused by launches becomes continuous when you plan 10 launches of HLLV per day. There will be formation and dispersion of a "ground cloud" made of exhaust gases and some sand and dust. Because of the low altitude of the cloud, people living near the launch site will be exposed directly to the cloud. The Committee on Toxicology of the National Academy of Science (NAS)/National Research Council (NRC) have recommended exposure limits [White, 1980]. The NAS/NRC recommendations include a short-term public limit (STPL), designed to avoid an irritation of the moist mucous membrane of the upper respiratory track, and a public emergency limit (PEL) related to accident conditions that might result in some irritation but with reversible effects. It is thought that launches of a solar power system ground-cloud concentrations would probably be far beyond the STPL and PEL values because, according to the launch condition stated before, there will be one HLLV launch every ten day at the same launch site. However, quantitative information related to the HLLV launch is of course not available at present. We must make further investigations on the influence of the ground cloud. The organizations responsible for the huge plans such as Solar Satellite Power Program must follow the advice coming from research on the effect of pollutants including the contents of ground cloud.

Thermal Effects

Thermal power released from the HLLV is in the order of 103 GW. It is considerably high power rate, but duration time of burning only 100-200 seconds. If we assume 100 of HLLV launch, the average power only 0.63 GW. This heat source corresponds to a typical small scale oil burning power generation station. It may affect local whether. It is not likely to have serious effect on local whether. Therefore, we can avoid serious thermal effects by choosing launch site appropriately.

Noise Effects

The main source of launch noise is the turbulence in exhaust. Other noise mechanisms may be present in a rocket engine, but they can be neglected. A preliminary evaluation of the noise impact of launching a solar power satellite system has been done [White, 1980]. In the report, there are suggested some negative effects of noise, which are as follows:

Hearing Damage

The official requirement in US for maximum exposure is 115 dB. According to the results of preliminary research, a potential hazard would exist within 1500 m from launch point. Using more strict technique employed by EPA, it should not exceed 70 dB. In this case, the range of potential hearing hazard would extend to 3,000 m. Therefore, all space center personnel would require hearing protection devices.

Speech Interference

The speech interference effects of the launch would be minimal since the duration of the intense noise is short. However, during launch itself and for at least 2 minutes thereafter, some speech interference would be present. It is thought that the duration of noise would not be long enough to severely impact the community surrounding the launch site.

Sleep interference

The possibility of sleep disturbance exists for distances as great as 30,000 m from the launch site. However, this effect will vary depending on the person, and also the background noise will influence the degree of sleep interference.

All of the considerations on biological effects described above are from the viewpoint of a large scale solar power satellite program. In the case of some small scale demonstration projects, the effects of launches will be negligible and insignificant.

6.2.3 On-Orbit Construction Effects

In the case of constructing a large satellite, most important effect is the space debris problem. Man made space debris comes from spent rocket stages, inactive/deactivated space crafts, rocket/spacecraft fragments, spacecraft/rocket separation hardware, solid rocket motor exhaust particles and spacecraft covering/thermal insulation. At the end of 1990, about 6,500 manmade objects were in orbit around the Earth, weighing in total about 2,000 ton. But, this space objects data is not complete, space scientists believe there are many more smaller objects. Figure 6.7 presents a space objects flux data. It includes both natural objects (meteoroid) and artificial objects.

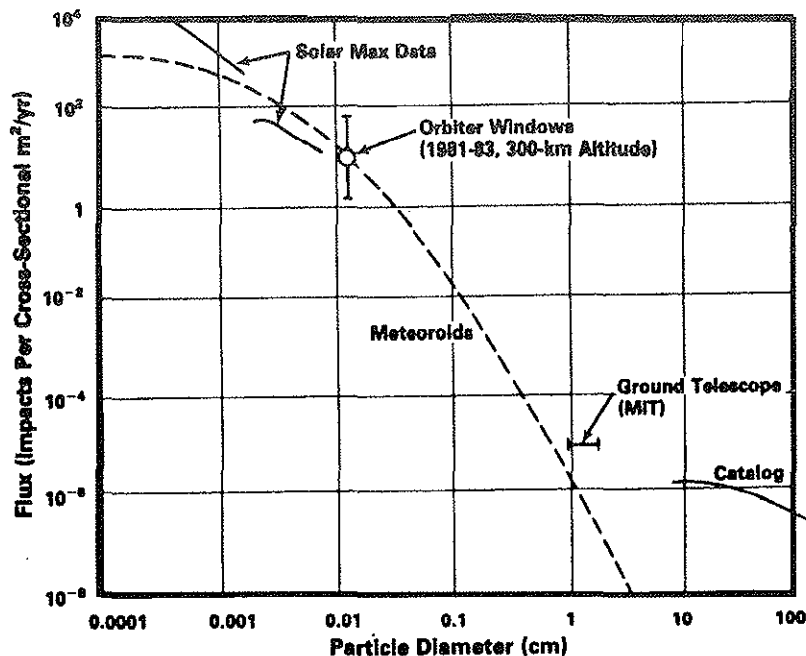

Figure 6.7

On the environmental point of view, solar power project makes two problems concerning with space debris. The first one is the impacts of space debris and a large satellite. For debris sizes less than about 0.01 cm, surface pitting and erosion are the primary effects. Because of the very large flux, the cumulative effect of individual particles colliding with a satellite might become significant. For debris larger than about 0.1 cm, structural damage to the satellite becomes significant. In the case of examination of Long Duration Exposure Facility (LDEF), 29.37 m² thick aluminum plates revealed 606 craters that were 0.5 mm in diameter or larger in 5.8 years exposure on LEO (lower than 480 km altitude). The flux becomes 3.6 /m²/year. In the case of solar power satellite 2000 (1000 km altitude), assuming the life time of the satellite is 10 years, only 80% of solar cells can survive. We have to develop some effective debris removal or protection system.

The second one is making space debris. Man-made debris are increasing, and according normal traffic model, the mass of them might become twice every 10 years. When we construct a large satellite like Solar Power Satellite, we have to launch many rockets. Additionally, when a satellite is constructed on orbit, much exhaust matter may be created. J. A. Angelo Jr. and T. E. Albert suggest that their 5 GW solar power satellite system will make 2.5 times space debris in maximum. Thus, our big project will make many space debris. Man-made space debris are not so much now, but if they are increasing this pace, quite serious situation will come out. The danger of Extra Vehicle Activity (EVA) will be increased and the accident of impact between inactive and active satellites might happen. But, more important situation is the final stage of such a large satellite. The satellite on low Earth orbit (LEO) will be fall into the atmosphere after its life. Such a large satellite cannot burn out in the atmosphere, and almost of it must fall on the ground. In the worst case, it falls on a big city keeping on its size. At that time, many buildings are destroyed, the city is burning up and millions of people will be dead. It cannot compare with the case of a small meteoroid. It will be the biggest and unprecedented disaster in our history. We have to worry about its final stage. One solution of it is drawing it to high altitude orbit for not falling into atmosphere. In such a case, space debris increase on the new orbit of the

satellite. Moreover, if we keep our mind on the final stage, we cannot avoid that an unexpected situation make it destroy and a part of it falls into atmosphere.

Another effect of constructing a large satellite is breaking the Van Allen belts. The Van Allens belts surround the Earth and are formed by charged particles. The particles move between the north pole and south pole very quickly. The solar power satellite is very large structure. Such a large orbiting space structure disturbs particles forming the Van Allen belts. But the Van Allen belts are spread $10^8 - 10^9 \text{ km}^2$ and the area of Solar Power Satellite is about 10 km^2 . So the ratio of disturbing area is about 10^{-7} . It will be negligible.

Crew Health and Safety Concerns

Radiation

One of the most hazardous aspects of space activities on living systems is radiation. Unlike most of the dangers involved with solar power satellite construction, space radiation is initially painless. It is the extended term effects that are the chief cause of concern for this project. It has been demonstrated that astronauts have a greater likelihood of contracting cancer years after their mission than the general public. [Peterson and Nachtwey, 1990] With increased EVA required for construction of a large solar power satellite, more astronauts will be exposed to greater amounts of space radiation than ever before and thus radiation is a major concern.

Non-ionizing radiation is a general term for electromagnetic radiation (EMR) from wavelengths of 10^{-5} cm ($3 \times 10^9 \text{ MHz}$) to 106 cm (0.03 MHz) including: part of the ultraviolet spectrum, visible light, infrared, microwave and radio wave radiation. Its effects on human health are described in a previous section. Transmitting power from a solar power satellite to other sites in space or to the Earth "may produce potentials for EMR exposure above current terrestrial levels" and this should be evaluated both in space and on Earth as part of the ongoing health and safety concerns [Vanderploeg, 1992].

Ionizing Radiation refers to high-energy particles and photons which can induce electrons to separate from their parent molecule when in close proximity to the molecule. Thus, primary ionizing radiation (with energies of megaelectron volts - MeV) produces millions of electrons (with energies of electron volts - eV). These secondary electrons can disrupt cell processes by breaking up molecules such as DNA or by creating reactive chemical radicals [Letaw, 1992]. There are three primary sources of ionizing radiation in space.

Galactic Cosmic Radiation (GCR) - originates outside the solar system; composed chiefly of protons, alpha particles (helium nuclei) and a small amount of heavier nuclei. These particles penetrate deeply into matter. Energy levels typically average $300 - 3000 \text{ MeV}$.

Trapped Radiation - electrons and protons of the solar wind which are geomagnetically trapped in the Van Allen Radiation Belts or of the South Atlantic Anomaly (SAA). The Van Allen Belts consist of a higher belt, mainly of electrons, at about 10000 km above the Earth and a lower belt at $800 - 1200 \text{ km}$. Energies are typically $30 - 300 \text{ MeV}$. The SSA is a discontinuity of the Earth's geomagnetic field in the Southern Hemisphere where the inner Van Allen Belt dips down to lower altitudes.

Solar Energetic Particles - particles, mostly protons, emitted from the sun during solar flares. Solar flares follow an 11 year cycle of activity. Energies are typically $10 - 100 \text{ MeV}$ [all energy values taken from Letaw, 1992].

From this knowledge, it would be suggested that if construction is carried out in Low Earth Orbit (LEO) care is taken to avoid the SAA as much as possible and absolutely no EVA be carried out in this area. An orbital inclination of 28.5° and 500 km altitude will pass through the SAA for six orbits, then miss it for nine orbits. A spacecraft in LEO is protected from the outer belt trapped electrons, galactic cosmic radiation and normal solar flare radiation [Newman, 1992] that would pose safety problems for construction in a higher Earth or Geostationary Earth Orbit (GEO). It is therefore proposed that on-orbit construction be performed in LEO and the structure(s) boosted to a higher orbit if necessary, with a minimum of EVA at higher orbits.

Radiation Dose Concept

Absorbed dose is the amount of radiation energy deposited in tissue. It can be expressed in units of the Gray (Gy) or radiation absorbed dose (rad).

$$1 \text{ Gy} = 1 \text{ Joule/kilogram}$$

$$1 \text{ rad} = 100 \text{ ergs/gram} = 0.01 \text{ Gy}$$

However, the same absorbed dose can result in different degrees of biological effectiveness, depending on the type of radiation. The *Linear Energy Transfer* (LET) is a measure of the energy loss per length of path. Charged particles with a high energy loss rate are more effective in producing biological effects than particles with low energy loss rates. Therefore, a quality factor, *Q*, based on the ability of each type of radiation to produce ionizations along its path is included in the term *dose equivalent*. $Q = 1$ for X-Rays, Gamma Rays, and Beta Particles. $Q = 20$ for alpha particles [Vanderploeg, 1992]. Dose equivalent is most closely related to biological risk.

$$\text{dose equivalent (sievert, Sv)} = Q \times \text{absorbed dose (Gy)}$$

Dose equivalent is also measured by the rem (roentgen equivalent, man)

$$1 \text{ rem} = 100 \text{ ergs/gram} = 0.01 \text{ Sv}$$

Radiation Effects on Biological Tissue

Radiation can act on the nucleus of a cell to cause a physical cleavage in the cell's chromosomal DNA. This cleavage can lead to cell death, or possibly loss or mutation of a segment of the DNA. In this way, a previously normal cell can be transformed into tumor producing cell or even a malignant, cancerous cell. The most susceptible cells to radiation exposure are those cells of low differentiation and high mitotic rates: blood forming cells of the bone marrow, intestinal cells, skin cells, hair cells etc.. Less susceptible are those more highly differentiated and of low mitotic rate such as muscle or nerve cells. It is becoming apparent that there is no clear threshold value below which radiation exposure is safe [Davies, 1992].

Acute radiation effects generally refer to exposure to a high dose of radiation over a short period of time, manifesting as "radiation sickness". Dose equivalents of 100 - 200 rem cause nausea and vomiting within hours, usually disappearing within a day or two. 200 - 1000 rem causes nausea, vomiting, diarrhea and after a latent period of two weeks, possible hemorrhaging and hair loss. Doses over 600 rem are generally lethal but can be recoverable with medical attention. Doses of 500 - 1000 rem are possible in severe solar flares as occurred in August, 1972 [Letaw and Clearwater, 1986]. This necessitates a storm shelter of some kind in the space craft. *Delayed effects* of radiation can occur years after prolonged exposure to high or low doses and include leukemia, cancer of the breast, digestive system and lung as well birth defects in progeny.

Space Radiation Protection

Protection from dangerous levels of exposure comes from shielding of astronauts in space as well as standards set for the allowable exposure limits. A few pharmacological agents which function as scavengers to the damaging radiation induced free radicals are available but these drugs are often toxic themselves at effective levels. Figure 6.8 [Letaw et al., 1987] shows the dose equivalent per year to the bone marrow from galactic cosmic radiation as a function of aluminum shielding thickness. As it is expensive to add such shielding to a spacecraft, more economical alternatives are to include other materials, such as water or fuel between the outer and inner environment of a spacecraft. In on-site habitats, it would be wise to require that astronauts spend their off duty time in some more shielded area of the craft. Protection from solar flares requires a unique "storm shelter" in the space craft and *around the construction area*. Protection from GCR is more difficult and little can be done in an orbiting space station.

Table 6.6 are the astronaut exposure limits set by NASA. Current NASA regulation limits occupational exposure to 1.25 rem per 3 months and 5 rem per year. These are important values for construction crews of a solar power satellite which may have their mission duration determined by these limits.

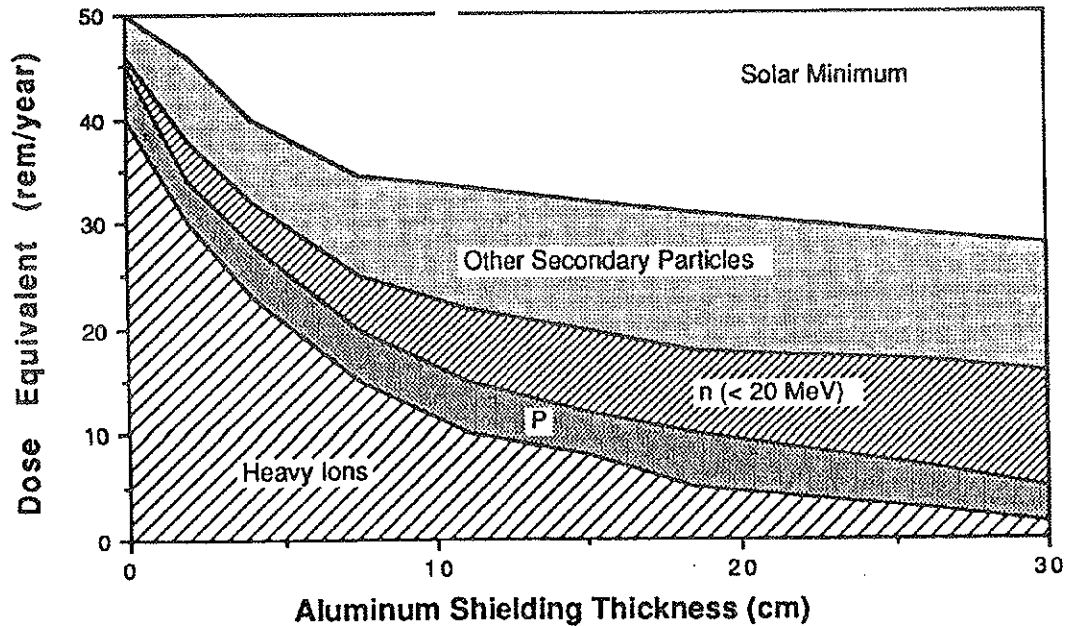

Figure 6.8 Dose Equivalent as a Function of Aluminum Shielding Thickness

Table 6.6 NASA Astronaut Organ Dose - Equivalent Radiation Exposure Limits

Time period	Blood Forming Organs (rem)	Eye Dose (rem)	Skin dose (rem)
Career	200 + 7.5 (age-38) females 200 + 7.5 (age-30) males	400	600
Annual	50	200	300
30 day	25	100	150

Cardiovascular Adaptation

With the loss of gravity's influence on the circulatory system, it is well established that a general cephalad fluid shift occurs as the fluid volume redistributes, free of the 1g force which normally pulls it Earthward. Symptoms of this fluid shift are facial puffing, sinus congestion, engorged neck veins and a remarkable reduction in lower limb girth (irrespective of muscular wasting). Blood pressure sensors, aortic and carotid baroreceptors, in the upper body sense only the increased blood volume and hence cause increased fluid loss through urination, resulting in a new lowered set point of blood volume. The primary concern comes with reentry into a 1g environment and a sudden loss of upper body blood volume, often resulting in fainting. This has been countered with a pre-return oral intake of fluid. However, the redistribution of body fluid and new set-point must be considered in any medical treatment or procedure in micro gravity.

A more important concern to on-orbit construction may be reports of occasional arrhythmia's [Dietlein, 1983] detected especially during EVA. More research must be conducted on the impact of

space flight on the electrical activity of the heart before large scale EVA operations occur and careful attention must be paid to this during EVA operations. As well, the cardiovascular deconditioning could be a problem if a strenuous EVA or IVA task is required. Due to the reduction in blood reserve, the astronaut may not be able to supply the tissues with sufficient perfusion and performance would be affected. To counteract this deconditioning, an aerobic (high frequency, low resistance) exercise such as a treadmill or bicycle regime needs to be followed by the crew [Logan, 1992].

Musculo-Skeletal Effects

In the absence of gravity, there is a decreased force required by skeletal muscle to perform certain tasks as compared to the same exercises on Earth. As a result, muscle has been seen to atrophy over the course of space flight without proper countermeasures. In particular, the most marked loss of muscle has been observed in muscles that have an antigravity function on Earth, for example the extensors of the leg such as the calf and quadriceps [Edgerton and Roy, 1992]. It is likely that the hip, back and neck extensor muscles also atrophy but this has yet not been proven. With inadequate use, muscles of the upper limbs will also atrophy in micro gravity, but to a lesser extent. Considering the importance of maintaining adequate strength to perform extravehicular activities (EVA) and construction for SPS, it is recommended that astronauts be placed on an intensive weight training regime prior to flight and follow a strength and intensity exercise regime (low frequency, high resistance) during their duration in micro gravity [Logan, 1992].

Accompanying decreased muscle use in micro gravity is a decreased muscle load on parts of the skeletal system. It is believed that this may be the main cause of calcium depletion and bone resorption in micro gravity [Cann, 1992]. Hormonal influences are likely the effectors of this calcium loss and changes in hormone balance in micro gravity may also be involved. It is proposed by Cann that a very specific exercise regime along with diet and pharmacological supplements be employed by astronauts in micro gravity to help offset this problem. This will be very important in order to avoid fractures induced by EVA construction activities.

Decompression Sickness

Decompression Sickness (DCS) is the foremost medical problem and health maintenance challenge facing EVA operations for orbital construction [Barratt, 1992a]. DCS is caused by evolution of nitrogen (N_2) bubbles in the tissue, induced by a state of nitrogen supersaturation relative to ambient pressure. This most often occurs with a sudden decrease in ambient pressure, as seen with divers that resurface too quickly, or astronauts that move from a high pressure cabin to a lower pressure suit to perform EVA, or experience a sudden depressurization of their suit during EVA. The present mechanism for preventing DCS is to require astronauts to perform a "prebreathe" period in the airlock of the spacecraft (where the pressure is gradually reduced) and as well to breath 100% oxygen in this period just prior to EVA. The oxygen purges the circulatory system of nitrogen and thus lessens the risk of bubble formation. The clinical manifestations of DCS include localized joint and limb pain and can involve more serious pulmonary and neurologic damage.

Space Adaptation Syndrome

About one half of all astronauts have been affected by space adaptation syndrome and space motion sickness during the adaptation period to micro gravity (about three to four days). The characteristic symptoms are lethargy, anorexia, pallor, sweating, headache, general malaise, nausea, and vomiting. The present theory on the origin of this problem is that motion sickness is the result of a sensory conflict in the brain resulting from discordant sensory inputs in micro gravity from the vestibular organs, the visual system, somatosensory organs, kinesthetic inputs etc.. EVA has thus been excluded during the first three or four days in space. At the very least, an astronaut may suffer from discomfort and decreased productivity during the adaptation period and at worst may have a life threatening encounter in the event of emesis while inside an EVA suit. Expelled stomach contents could be either aspirated, or could obstruct life support feeds to the suit producing an immediate threat to life.

Current countermeasures against space motion sickness center around pharmacological agents, but undesired side-effects such as drowsiness often accompany the therapy. At present, there is no definitive way to counteract space motion sickness and this danger will likely necessitate a new crew to wait until the adaptation process is over before they can safely begin EVA. Proposed modifications to EVA suit design will be covered in a subsequent section.

Crew Selection and Psychological Considerations

The type of mission that a large solar power satellite construction will require will likely be unique from the short duration US Space Shuttle missions and even the longer duration missions more typical of the Soviet / Russian space program. The construction of the proposed Space Station Freedom will likely provide us with helpful information on what factors are important in space construction crew selection and crew interactions and schedules. Due to the large cost of transporting crews from Earth to the construction site, the crews will likely remain in orbit for extended durations, necessitating some type of habitat. The duration of EVA is predicted at around six or seven hours for Freedom construction [Barratt, 1992]. This regime of long working hours for extended durations will require some scheduling of time off for crew members and will need to be worked out considering the expense of the workers' time, the productivity and safety of operations etc.. As well, the type of individual best suited to carry out large scale construction in space has not received much attention. What type of background training should they possess? Should they be selected from the same pool as traditional astronauts or from a pool of those who carry out construction on Earth? These issues need to be examined in greater detail before large scale construction is attempted.

Medical Facilities and Crew Habitat

Ideally, a large scale space construction project would include facilities providing a maximum level of medical care to those involved. Realistically, the facilities will maintain an intermediate level of medical care targeted toward the most likely problems, with the ability to transport to the ground if required [Barratt, 1992b]. Another important concept is that the hardware provided to treat these medical incidents must be matched by an appropriate skill level of the medical officer. As well, the medical officer should have access to both an on-site and ground medical database with diagnostic software and crew histories. Additionally, a telemedicine link should be set up between the facility and flight surgeons on the ground.

Recognized physiological responses to micro gravity and appropriate countermeasures have previously been discussed. Table 6.7 [Barratt, 1992b] outlines possible likely events of SSPP construction requiring medical treatment.

Table 6.7 Possible Events Leading to Requirement for On-Orbit Medical Care

Event	Potential Causes	Emergency Procedures	Medical Impacts
Loss of Pressure	Debris/meteoroid impact Systems failure Seal / Hatch Failure	Seconds to hours (Don O ₂ masks, pres. suit, repair, evacuate)	Decompression disorders Hypoxia Trauma (secondary projectiles)
Fire/Explosion	Electrical circuit overload Volatile material release Rupture of pressurized container	Seconds to minutes (don O ₂ masks, goggles, extinguish fire, evacuate immediate area) Minutes to hours (effect repairs, evacuate)	Burns Smoke inhalation Blast trauma
Toxic Substance Release	Rupture of Containment line or vessel	Seconds to minutes (don O ₂ masks, evacuate affected module, stop toxic release) Minutes to hours (decontamination, clean up procedures, gloves, etc., evacuate)	Toxic inhalation Lung injury Hypoxia
Primary Medical Event	Decompression sickness Electrical shock Infectious disease Isolated trauma	Seconds to minutes (emergency care, CPR, stabilize for treatment or transport) Minutes to hours (treat with available medical facilities, evacuate ill or injured)	Per primary event Cross infection of crew Rapid use of medical consumables

Radiation Exposure	Solar flare event Nuclear power system failure Experimental mishap Artificial Event Ground or orbital nuclear detonation	Second to minutes (evacuate radiation area, safe haven, shielding , stop release if possible) Minutes to hours (decontamination, clean up procedures, treat radiation injured crew, evacuate some or all crew)	Acute radiation syndromes (gastrointestinal, central nervous system, hematologic effects) Long term exposure factors (risk of future malignancies , career limiting doses)
Loss of Attitude Control	Guidance/navigation system failure "Stuck thruster"	Seconds to minutes (correct problem, power down spacecraft) Minutes to hours (correct problem, evacuate)	Trauma Neurovestibular Disorientation
Environmental / Life Support System Failure	Mechanical failure Electrical failure Loss of consumables	Seconds to minutes (halt further damage or loss of consumables, treat medical conditions) Minutes to hours (repair damage, evacuate)	Hypoxia Hypercarbia Hypothermia Hyperthermia Dehydration

Decompression sickness is of particular concern considering the large amount of EVA and will require a hyperbaric chamber with oxygen administering equipment. Radiation protection will require a storm shelter in the spacecraft to house the crew in the event of solar flares, and appropriate short term treatment facilities for radiation exposure are required. Treatment of common problems such as respiratory infections, contact dermatitis, and minor trauma (broken bones, sprains, burns etc.) will be of importance. While restrained by feet holds in EVA, large torques are easily placed on the ankle bones and this increases the risk of fracture. As well, working with large mass objects in space provides the opportunity for severe crush injuries.

The life support system of the facility must be constantly monitored in order to detect failures that may leave the crew without water or introduce toxic substances into the environment. Environmental monitoring to track inherent biological hazards such as any volatile substances, particulate matter and microbial loads is also necessary. Non-toxic disinfectants must also be developed to combat an increase in microbial load.

There is the possibility of worker contamination during EVA, especially from fuels such as hydrazine or nitrogen tetroxide. Hydrazine is inhaled or absorbed through the skin and can cause respiratory and cardiovascular problems. Nitrogen tetroxide when inhaled causes respiratory problems as well. The contaminated worker should try to brush the material off the suit during EVA or possibly sublimate the excess by exposing the contaminant to the sun. Inside the airlock (which should be equipped with air monitoring and detection equipment), the contamination should be contained and removed. Affected surfaces should be washed and symptoms treated.

Other medical hardware is also suggested for the facility [Barratt, 1992]: standard physician's instruments; cardiac defibrillator/monitor with self adhesive pads and EM interference shielding; automated ventilator; medical restraint system to contain the injured, medical equipment and attendants in place; advanced life support pack with medications and medical hardware; portable oxygen supply; and stored intravenous fluids. More extensive equipment that is also suggested are: a clinical chemistry analyzer; a blood gas analyzer to provide arterial and venous O₂ and CO₂ levels; hematology analyzer to take red and white blood cell counts; a microbiology lab to identify microorganisms; dental treatment pack; head, ears, eyes, nose, throat kit; minor surgery kit for wound suturing, cautery, sterile dressing and intravenous lines - no general anesthesia or major surgery is suggested; pharmacy supplies; aspirator for vacuum suction; cardiac compression assist device; and a means to store biological samples and wastes.

Rescue and Recovery

Logan [1992] suggests three situations requiring a crew emergency rescue vehicle.

- On-orbit medical emergency
- Habitation or medical facility emergency
- A grounded primary crew transport vehicle

In the event of a medical emergency beyond the scope of on-orbit facilities, a crew member may have to be returned to Earth. A proposal for Space Station Freedom is for an Apollo style capsule, outfitted for patient stabilization and carrying up to six crew members (Barratt, 1992). The G forces on reentry must be minimized, to not more than 3G, for the safety of an already compromised patient, and only in the most physiologically tolerable (+Gx) body axis. For Space Station Freedom construction, NASA proposes the ability to remain in orbit for eight hours in order to permit splashdown within 100 miles of a medical care facility and a time of 3.5 hours from splashdown to medical center. Similar concepts should be adopted for an SSPP medical facility and crew habitat.

In the event of a facility or primary transport vehicle contingency (fire, loss of power, toxic exposure, loss life support, orbital debris damage of spacecraft, etc.) the emergency return vehicle could be used as a lifeboat until the other crafts regain function.

Life Support System

The proposed life support for the habitation/medical facility is that of a standard physical/chemical partially closed loop system that is supplied with food from Earth. Solid waste is stored. This is used for both Mir and Space Station Freedom design. Oxygen can be regenerated by electrolysis of water and water is reclaimed and purified by physical/chemical means. Other systems such as bioregeneration capabilities should be considered as they become available.

Extravehicular Activity

Man and Machine Coordination

In the construction of a large solar power satellite, a choice must be made concerning EVA activities to be carried out by man and those by machine. The cost and risk of manned EVA using current suits, dictates that the project must attempt to minimize this time [Barratt, 1992]. Zimmerman et al. [1985] have proposed useful criteria for Task Automation vs. Human Performance:

1. to avoid perceptual saturation
2. to reduce concurrent tasks
3. tasks on compressed timelines
4. to avoid human bandwidth limitations
5. routine tasks
6. memorization tasks
7. sequential and time tasks
8. monitoring tasks
9. time consuming, boring, and unmotivating tasks
10. emergency -prevention devices
11. complex mathematical or logical tasks
12. complex tasks that must be performed rapidly
13. to enhance system reliability
14. safety endangering tasks
15. systems with consideration to crew acceptance

The limiting factor of automated systems thus far has been a lack of dexterity. Telerobotic systems under development include the Flight Telerobotic Servicer, the Special Purpose Dexterous Manipulator, the Remote Manipulator System, and the Japanese Experimental Module servicing arms [Barratt, 1992]. These systems can incorporate the benefits of both man and machine while avoiding the risks of manned EVA. Today however, humans remain "easier to program or reprogram than any system of comparable capability". [Loftus, 1986] The exact construction tasks for SSPP will need to be outlined and the benefits of man or machine will need to be considered for each before the man - machine interactions are detailed.

Suit Design and Human Factors

EVA during construction requires a suit that will support and protect the astronaut and as well allow enough flexibility for construction activity. The current Extravehicular Mobility Unit (EMU) used by the NASA consists of the Space Suit Assembly (SSA) and the Portable Life Support System (PLSS). The SSA consists of a hard upper torso and soft lower torso, arms, and legs. The suit pressure atmosphere is 29.6 kPa, thermally insulated and of nearly 100% O₂. The Russian EVA suit operates at 40 kPa (but can be lowered to 30 kPa), and also consists of soft components except for a hard upper torso. Each suit can support EVA for about seven hours.

The increase in EVA expected for large SPS construction will require a modification to these designs. The extended duration of the EVA's increases the risk of orbital debris or micro meteoroid encounter. The construction process itself will likely lead to a greater risk of orbital debris, regardless of the safeguards against it. These safety concerns can most effectively be addressed with the use of a "hard" EVA suit that would reduce this risk of suit penetration.

Since the cabin pressure of the US Space Shuttle, Mir Space Station and proposed Freedom Space Station is 101.3 kPa, EVA activities in the lower pressure suits require either a lengthy (up to 4 hour) prebreath, or a lowering of cabin pressure hours before EVA to reduce the risk of DCS. Given the large proportion of EVA during construction, this difference between cabin and suit pressure must be minimized to increase safety and decrease preparation time. Since dexterity is generally sacrificed with increased suit pressure, using a low pressure cabin seems beneficial. However, if the habitat has other purposes such as conducting life science research as on current spacecraft, this permanent lowering of cabin pressure may not be possible and a high pressure suit may be required.

Currently, hard shell / high pressure suits are under development. The Mark III is a composite rigid structure and fabric design [Kosmo et al., 1990]. NASA's AX - 5 is a constant volume, all metal suit that operates at 57.2 kPa, and a European rear entry hard suit under development will operate at 50 kPa [Svensson et al., 1986]. The AX-5 has joints that move by rotating bearings instead of fabric deformation. One further design is of a double hulled metal suit to protect against debris. Current suits provide aluminum equivalents of 0.5 g/cm² (McCormack et al., 1989) while advance suits will provide 1.5 g/cm². For EVA in Geostationary Earth Orbit, a suit of 1.62 g/cm² is required [Thompson et al., 1986]. The major drawback of all EVA suits is glove design. Finger joints are difficult to move even in low pressure suits. Astronauts of the EASE (Experimental Assembly of Structures in Space - shuttle flight 61-B) project emphasized the fatigue felt in their hands and forearms [Cleave and Ross, 1986]. To achieve the necessary dexterity needed for construction, a better design is needed. In the construction environment, it is important that handrails, waist tethers, and footholds be among the first objects installed to facilitate construction.

Advanced suits should also incorporate real-time monitoring of vital EVA signs (cardiovascular system, respiration, metabolism, suit temperature and pressure etc.) so support systems can be automatically or remotely immediately altered. It is suggested that a one-way, flow-controlled conduit be incorporated near the astronaut's mouth to handle any emetic episodes inside the suit which are presently life threatening. A wide field of view combined with a helmet mounted display with video telecommunications may aid in construction activities. Other areas of improvement are in the development of longer life, rechargeable batteries and recyclable air regeneration systems. Checkout time for the suits must be facilitated as to reduce downtime. For EVA activity above Low Earth Orbit, enhanced suit radiation shielding will be required. Tools should be designed for one-handed operation and for maximum ease of operation. Workplace and helmet mounted lighting should also be included.

Regarding the amount of EVA activity with respect to DCS danger, Webb et al. [1988] report that 8 hours of EVA-level activity for five consecutive days at 65 kPa EVA simulation and breathing 100% O₂ showed no evidence of either DCS or oxygen toxicity.

6.2.4 Lunar Operation Effects

Utilizing lunar resources for manufacturing and construction of a large solar power satellite may decrease the project cost due to the much lower lunar launch expense as compared to Earth launch expense. Again, it is presumed that some manned activity will be necessary on the lunar surface. This introduces the need for crew habitat and medical facilities on the Moon. The increased distance from the Earth (as compared to construction in Geostationary or Low Earth Orbit), the introduction of approximately 0.16 of Earth's gravity, and the process of actual material manufacturing, poses a few distinct concerns and considerations to crew safety. As an extensive lunar presence is not planned for

the near term, and recent lunar base studies have been completed [International Lunar Initiative, 1988], this examination is secondary in scope to the on-orbit operations which will be required to a greater or lesser extent, regardless of lunar resource use.

Crew Health and Safety Concerns

The same basic concerns apply to lunar manufacturing as have been outlined for on-orbit construction. However, readaptation to a 0.16 G environment after an approximately three day flight to the Moon must be examined. The known physiological effects of space flight have been achieved chiefly through exposure to a micro gravity environment. Many physiological responses (cardiovascular, musculo-skeletal, and especially vestibular) will be substantially different in a 0.16 G environment. Exercise regimes for cardiovascular and musculo-skeletal maintenance may be modified. Vestibular readaptation may reintroduce or heighten space motion sickness symptoms.

Radiation is a substantial medical problem for lunar activities as the Moon has no radiation-absorbing atmosphere and no overall magnetic field to deflect incoming charged particles. The Earth has a mean radiation dose equivalent of 0.1 - 0.2 rem / year while the lunar surface radiation dose equivalent is 20 - 50 rem / year [ILI, 1988]. It is proposed that for extended lunar activities the acceptable dose equivalent should be set to 5 rem/year [Lunar Storm Shelter Concept Design, 1988]. Exposures must be monitored with personal dosimeters to keep accurate individual records. For prolonged habitat on the Moon, a shelter with shielding of density 400 g/cm² is required to bring radiation exposure levels to below 5 rem/year [LSSC, 1988]. In order to be well protected against solar flare activity, shielding should be between 700 - 750 g/cm². They recommend that without substantial shielding, the duration of lunar stay should not exceed 70 days. These exposures must be considered when planning habitat facilities and duration of astronaut rotation for lunar manufacturing. EVA on the Moon must be accompanied by portable "storm shelter tents" to provide protection from solar flares. Since increased solar activity can be detected between 20 and 30 minutes before it arrives at the lunar surface, these shelters must be placed within 20 minutes travel time of each other and the permanent shelter [LSSCD, 1988].

Creation of a Lunar Atmosphere

With construction activities, machinery, and lunar launches, a tenuous lunar atmosphere may be introduced where the residence time of various chemical will depend on their molecular weight. Some of these chemicals might have potentially negative impact on lunar soils and lunar bases. This atmosphere would come chiefly from exhaust fumes and would most likely be toxic to humans as well. Monitoring of toxic substances is essential for human presence and their production should be minimized by utilizing cleaner sources of energy (i.e. solar energy). A potentially greater problem is the dust which may contribute to "atmospheric" problems, especially with substantial disturbance of the lunar surface that mining and manufacturing would provide. This must be examined as well, and dust reduction strategies may be necessary. An expected increase in man - machine interactions with lunar manufacturing increases the risk of occupational injury, including primary medical events such as bone fracture, sprains, crush injuries, other trauma, etc..

Medical Facilities and Crew Habitat

The medical and living requirements of a lunar crew would be very similar to those outlined for on-orbit construction. Since the Earth is approximately a three day journey, there needs to be slightly more extensive care available for a manned lunar operation. The main addition would be for capabilities of minor surgery including anesthesia. The medical facilities could be more tailored to an Earth based occupational medicine treatment model. With present technologies, it is recommended that the facilities' life support system be physical/chemical, and partially closed as was the on-orbit design.

Extravehicular Activities

Man and Machine Coordination

Manufacturing and construction in lunar gravity reintroduces the need to overcome weight for material manipulations. This forces a heavy reliance on robotic operations and introduction of man in the loop only when necessary for control or high dexterity operations. Safety controls must be introduced into the robotic operations to insure that maneuvers do not jeopardize the integrity of EVA crew or crew facilities.

Suit Design and Human Factors

The surface EVA suits need to be lighter, more durable, more dexterous and more mobile than on-orbit models. Vallerand [1991] suggests that the PLSS garment weight can be reduced by using air-cooled thermal controlling instead of a water cooled mechanism and other PLSS. Temperatures on the lunar surface range from -171 to 111°C and must be accounted for in the thermal control system. As dexterity and mobility are of prime importance, low pressure soft suits or servo-assisted hard designs should be utilized. Once the extent of extravehicular activities are known, the suit shielding should insure that radiation exposures will not exceed acceptable limits. The expected dust around construction activities may be a problem for joint function as was noted for Apollo 16 [ILI, 1988] and may necessitate addition of dust seals to the design. Other suit addition suggestions of the on-orbit design (emesis conduit, helmet mounted display, etc.) should be included as well.

6.3 Rectenna Effects

Like current power plants (fossil fuel, nuclear, hydro-electric, etc.), the rectennas used in a satellite power system will affect the environment and human society around them. Other sections of the report cover the environmental effects of the power beam. The specific impacts of the rectennas for the design examples are covered in the appropriate design example sections. In this section, we examine the general non-beam impact of satellite power reception systems using rectennas (microwave or array farm) on the order of 0.25 km² or larger.

First, the initial construction of a rectenna will modify the environment and communities surrounding the site. Second, the operation and very presence of the rectenna and supporting structures and activities will modify the climate and socio-economic structure surrounding it.

6.3.1 Construction

Construction of a power reception system will affect the surrounding environment and socio-economic structure. The relative magnitude of the effects depend upon the design of the rectenna, the construction methods used and materials required, the size and character of the surrounding communities, and the sensitivity of the surrounding ecosphere. The effects should be addressed in specific environmental/social impact studies for each rectenna site.

Socio-Economic Effects of Construction

For a given size and design of rectenna, the construction effects on the surrounding society will be greater in small communities than large. Small communities generally lack the public service infrastructure required to handle the influx of people and materials during a construction boom. Large cities, on the other hand, can lose a minor construction boom in the noise level of traffic accidents, crime rate, divorce rate, and other statistical measures. In addition, the social structure of a small community can be shattered by the sudden addition of a large number of newcomers who don't know the local rules for behavior [ERG, 1980]. Larger communities are more used to handling large numbers of strangers.

One possible way of mitigating the negative socio-economic impacts is to build the rectenna in sections elsewhere, then ship it in and assemble the modules on-site. This modular approach has been used successfully to mitigate the social and environmental problems of constructing oil refineries in areas with restricted access, such as the North Slope of Alaska, USA.

Ecological Effects of Construction

The construction process will obviously affect the ecology of the site. In the NASA/DOE reference study, the rectenna design required the leveling of a large tract of land. This was expected to completely destroy the flora and fauna on the rectenna site. The types of replacement biota that would move in after construction were uncertain, though it was expected that the diversity would be greatly reduced [ERG, 1980].

This type of effect as is seen after clear-cut logging in forests. Sixty years and more after a clear-cut, the re-grown forest may look healthy. However, it is missing many herbs, wildflowers, and animals that don't migrate over large distances. The small species don't return, leaving the forest less diverse and consequently less healthy.

A construction of a land-based rectenna for space solar power reception need not create similar problems. The construction damage to land sites can be minimized by designing the rectenna to work without requiring leveling of the site - using pylons and a suspended structure, for example. In addition, as mentioned earlier, the rectenna can be built in modules off-site, then shipped in and assembled.

Damage to off-shore sites may necessarily be more severe. In most ocean sites under consideration (North Sea, etc.) at least the perimeter of the rectenna will need to be protected with a sea-wall. Construction of this sea-wall will destroy the sea-floor habitat under it. If the rectenna is to be placed in a polder, even more sea-floor habitat will be destroyed by draining.

6.3.2 Climate and Socio-Economic Modification

After construction is finished, the site will likely be much calmer. This obviously doesn't mean the rectenna will cease to be a factor in the local ecology and society.

Climate Modification by Rectenna Operation

Even if the construction doesn't destroy the local ecosystem, the design of the rectenna might unacceptably alter the local ecology. The porosity of the rectenna to sunlight, wind, water currents, and precipitation is one issue. The other issue is ongoing pollution from the operation of the rectenna.

Any land-based rectenna design is going to reduce the amount of sunlight striking the surface below it. In addition, the structure may act as a wind-break. It may also block necessary precipitation from reaching the plants below. Finally, depending on the vegetative cover and erosion characteristics of the soil underneath, precipitation may need to be trapped and channeled to a prepared drainage system. These effects will change the ecology and micro-climate of the areas under and around the rectenna - the exact changes depend upon the design of the rectenna and the site selected.

For off-shore rectennas, even if the rectenna is placed on a series of towers, normal currents and sea-floor motion will be restricted by the necessary sea-wall. If the rectenna is placed in a pumped-dry polder, the sea-floor and water-borne habitat will be destroyed. In the first case, the resulting structure might allow a new, more diverse water-borne ecology to develop than is normal - in essence an artificial reef. If the rectenna is built in a polder, the water-borne habitat might be replaced by agriculture or wild "island" habitat.

Unlike fossil fuel power plants, a satellite power reception system will not produce chemical pollution from combustion - the largest source of ongoing pollution will come from waste heat produced during operations. (The effects of micro-wave and near-IR laser irradiation on the surrounding ecology were considered previously.) Satellite power reception systems are likely to have a lower quality of waste heat than other types of power plants. The waste heat is also likely to be dumped in an uncontrolled manner. However, because the power conversion in a rectenna is not accomplished via a turbine that requires a large temperature difference between input and output, the total amount of waste heat produced by a satellite power system rectenna will be less than that from traditional power plants.

In addition to the rectenna, the impact statements for each site must consider the power grid links, support buildings and maintenance activities. All these will produce continuing effects on the local climate and will affect wildlife habitat.

Socio-Economic Effects of Rectenna Operation

The socio-economic effects of rectenna operation are much less than those from construction. The number of jobs required for operation and maintenance will be a noticeable income source only for small communities. The numbers required (on the order of 100 people for a 2 km square facility) are easier to integrate with the surrounding communities' social structure - especially if local hiring is used [ERG, 1980].

The big question will be - who owns rectenna? If a private company is the owner, the local government is likely to gain a large increase in its tax base (assuming property taxes are used to raise revenue). On the other hand, if the facility is owned by a government or quasi-governmental entity, the local community tax base will not increase as much [ERG, 1980]. This will be significant when dealing with the secondary economic growth that the rectenna is likely to produce. Without an increase in the tax base, the government will find it more difficult to provide needed municipal and utility services.

6.4 Security and Maintenance

In this section, "maintenance" means how to handle a crisis which has not been predictable such as a huge crack or destruction of the solar power satellite. The word "security" means how to protect large structures in space from misuse. If the solar power satellite will be realized, it will be one of the favorite targets for terrorists. They will be able to use the beam for the purpose of attacking and burning of distinct areas by changing the direction of the power beam. Moreover they can destroy the satellite to stop the provision of electricity.

To protect human beings and the environment on the Earth, a system that can completely prevent any harm originating from the solar power satellite is required. Detailed discussion of this topic takes place in another chapter of this report. Therefore, in this section, we will only treat the basic idea.

The progress in the field of military weapons in this century has been tremendous. From early 20th century, airplanes and submarines for military use were developed. In addition, bombs and torpedoes were invented. Technology to beat the enemy culminated in the use of nuclear weapons. Such an advance made it possible to kill a huge number of people at once. However, especially related to World War II., one thing that we must not forget is that both Axis and Allied powers intended to use these devastating tools to a great deal against unprotected people. In this discussion "unprotected people" refers to ordinary citizens.

Quite recently, there was one evidence that this barbarous tendency in the world has decreased to some extent. That was the gulf war [Ikeda, 1992]. The Iraqi troops could not persecute the captives. The UN-forces had to emphasize that they had only attacked military facilities. Why? This was mainly due to the evolution of communication systems that enabled people all over the world to watch the situation in real-time. Of course there is some criticism claiming that many people enjoyed the live war-show or most of the press were not neutral. Nevertheless, it was the fact that the communication systems could be helpful in inhibiting the indiscriminate application of military power to the unprotected people. This is the age where any politicians cannot ignore the unseen but powerful intention of the ordinary people on this planet. Besides, the influence of the United Nations can not be ignored.

In order to always keep the solar power satellite safe for the Earth, we put emphasis on the existence of the UN. Needless to say, it was founded to prevent the disaster of World War II again. The solar power satellite itself must not be made for military use. However, nowadays there are many critical problems that need world-wide cooperation on this planet. The existence of the UN has been accompanied by a lot of helplessness. The problem is whether people on this planet ignore such a world-wide organization or not. The presence and influence of solar power satellites will be global. Therefore, UN will be responsible for watching and protecting the large structure in space and providing the information to the people on the Earth.

Besides the previous issue, to educate people properly is the most important task. The education will have to be based on the agreement that all people related to Space Solar Power Program are responsible for the security and maintenance. If we will obtain many evidences that will show dangers in Space Solar Power Program, we will have to vigorously provide such information to the citizens all over the world so that they might not be manipulated by some governmental organizations or a large companies.

Overall Considerations

Nature in itself strives constantly for equilibrium. It acts in a rhythmic, compensatory, and dialectic way, always correcting itself in order to avoid extremes and excesses. This indeed may be living nature's profoundest law. Man disrupts this spontaneous compensation by exploiting and consuming the huge natural resources, reasoning with abstract principles and proceeding by deduction and logical continuity [Huyghe & Ikeda, 1992].

People today demand inexhaustible energy sources for the sake of still greater comfort than they enjoy at present. In addition, energy demands in the developing countries are now greatly increasing.

As we described in section 6.1 - 6.3, there would be great deal of hazards related to the construction of huge solar power satellite and rectenna. We should know the reason why we have to plan out such dangerous program.

Even supposing that utilization of solar energy or nuclear fusion provides limitless supplies of energy, raw materials on which to apply the energy are finite. In other words, the problem we must address is not energy itself but the human desire for limitless energy.

Now inhabitants on this planet have to restore the harmony on the whole world. This does not simply mean that we must abandon our advanced civilization or change our life style into extremely low energy consuming way as in the primitive era. We have to construct the new civilization in which energy supply and demand are balanced by the way harmless to the Earth. To realize such a civilization, for the sake of developing the new technology, self-developed motivations inside human to protect not only himself but also other humans and environment will be critical. Without the motivations to protect ourselves, all efforts that we have made to develop space solar power program would have no value.

6.5 Planning and Scheduling

If energy is transmitted through the atmosphere by means of electromagnetic radiation, part of the energy is dissipated in the atmosphere and can cause several effects: ohmic heating, thermal self-focusing, molecular absorption losses and scattering, as shown in section 6.1.1. Considering the effects of several frequencies in the microwave and infrared range, we suggest the use of microwave frequencies 2.45 GHz or 35 GHz. Each frequency has however, advantages and disadvantages.

Considering the use of visible laser beam usage for power transmission, the energy density on the ground must be less than 10^{-6} W/cm² to prevent injury to sensitive biological tissues such as the retina of humans and other animals. If we use microwave frequencies around 2.5 GHz, the power density upon the uncontrolled common animals (including humans) should be less than 0.5 mW/cm² in order to prevent most defined and as yet not well defined biological effects. As yet there has been no substantial research into the effects of microwave frequencies around 35 GHz on biota. Precise prediction of microwave effects on plants are impossible to determine because there has been too little research on this subject as well. Consequently, a prediction about the overall ecosystem is also impossible based the present data accumulation. We must therefore design and implement basic research experiments in order to answer the remaining questions of power beaming effects on biota. Considering Demonstration 2, the space to Antarctica power beaming, it is a concern that the proposed demonstration may have an overall negative effect on the biota and the space to Earth demonstration should utilize another receiving environment.

Microwaves at high powers can be harmful to electronic devices. Radio communication using frequencies in the same band as the solar power satellite beam may be interfered by the power beam, but we do not expect to have any serious effects on other commercial equipment from a solar power satellite beam outside the main lobe. A solar power satellite beam may interact with low amplitude (weak) signals which are utilized for radio astronomy and more work must be done on this area to identify any potential problems.

In the case of the proposed demonstrations, only a few launches will be involved. The impact of a limited number of launches is considered to be minimal on a global scale. On the other hand, the construction of a large scale solar power satellite might require hundreds of launches per year for many years. Such a large number of launches has effects on the atmosphere which are difficult to assess. Nonetheless, major potential problems include the production of long lasting contaminants in the mesosphere which might perturb remote sensing. In addition, there may be plasma density perturbations in the ionosphere and magnetosphere which might result in communication interference. Effects of large numbers of launches and resulting pollution on biota are not yet established and more research in this area needs to be done.

In the on-orbit construction of a space structure such as the large solar power station it is inevitable that there will be a requirement for manned activities. The identification of safety concerns and the provision of necessary medical care thus becomes an essential component of Space Solar Power Program. As well, both intravehicular and extravehicular life support structures must be designed in order house the crew and allow for safe construction to occur. Radiation exposure, cardiovascular deconditioning, musculo-skeletal degradation, decompression sickness, space adaptation syndrome, and crew make up are all factors that pose special problems for manned construction of a large space structure. Medical facilities need to be tailored to the needs of space construction and medical events that exceed these capabilities must be transported back to Earth. Development of a hard-shell, high pressure extravehicular suit is required to protect against radiation, decompression sickness, and possible debris in the construction site.

Lunar resource use for satellite manufacturing will also require some manned presence and therefore habitat and medical facilities. More extensive medical care is required due to the longer travel time to Earth. Lunar gravity poses unique physiological problems, and unique adaptation responses will likely be seen. Most of these issues have not been previously studied in detail. Reintroduction of gravity increases the need for robotic operations and as well, requires that a more dexterous, mobile, EVA suit be developed.

The rectennas used in a satellite power system will affect the environment and human society around them. Each proposed rectenna location should have an environmental and social impact statement prepared that addresses the effects of construction and operation of the rectenna. Rapid construction using large amounts of fresh water and many workers near small desert communities will have a very negative ecological and social impact. This can be mitigated by building modules elsewhere and shipping them in, as is currently done in environmentally sensitive areas (for example, on the North Slope of Alaska in the United States). Likewise, rectenna designs that require dedication and leveling large tracts of land, thus destroying natural habitat, are less desirable than designs that allow multiple use and preservation of maximal natural habitat.

Finally, the security of any space solar power satellite must be insured. No nation or group of individuals may be allowed to misuse the satellite in a manner that is directly and unduly harmful to humans, or other biological and physical components of Earth's environment.

In order to answer the questions that remain regarding the effects of power beaming on the environment and safety of ecological systems and living organisms, fundamental research is essential. We must implement a general research plan to predict the effects of a solar power program before each phase of the program can be realized. When the objectives of a particular demonstration are defined and an Environmental Impact Statement is made (see for example section 10.3.3), we must consider step by step tasks which will enable the demonstration. The proposed schedules are divided into near term and long term tasks with demonstrations as milestones in the overall development of a large-scale solar power program.

Figure 6.9 shows the near term environmental tasks starting with the commencement of a space solar power program and ending with preliminary results from the conclusion of Demo 2, a demonstration of space to Earth power beaming. As Demo 1 concerns space to space power beaming it is not extensively considered in the environmental testing. The research program can be seen to be divided into two major branches, *investigations on power transmission effects* and on the *environmental effects of the rectenna*. Each of these is then broken down into more detailed topics for experimentation. The time frame of this near term investigation is a total of 17 years with the space to Earth demonstration occurring 13 years after the start of the program. Preliminary results are expected up to four years after the launch of Demo 2.

Figure 6.10 considers the long term environmental tasks beginning with the launch of Demo 2 and ends 19 years later. The tasks considered can be divided into four parts, the *continuation of previous environmental testing*, *new investigation of the environmental impact on the extraterrestrial environment*, *medical and crew safety and security investigations for assembly and maintenance*, and *investigation on the effects of frequent launches on the Earth atmosphere*. Under the heading *continued environmental testing* one should note that the *epidemiological studies near rectenna sites* is a very long term research endeavor and continues well beyond the scope of this testing phase. Finally, the major milestone in this testing phase is the demonstration of 1 MW power beaming from a human assembled space solar power system which is launched seven years after the launch of demo 2 and allows for 12 years of data collection before the end of this research phase.

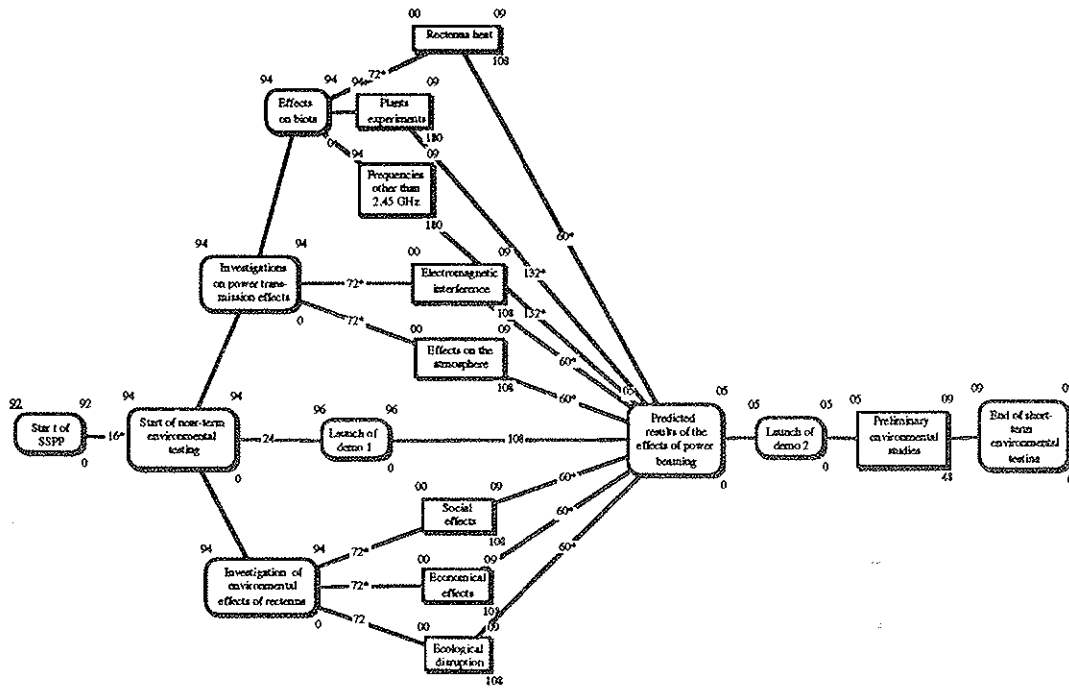

Figure 6.9 Near-Term Environmental Tasks

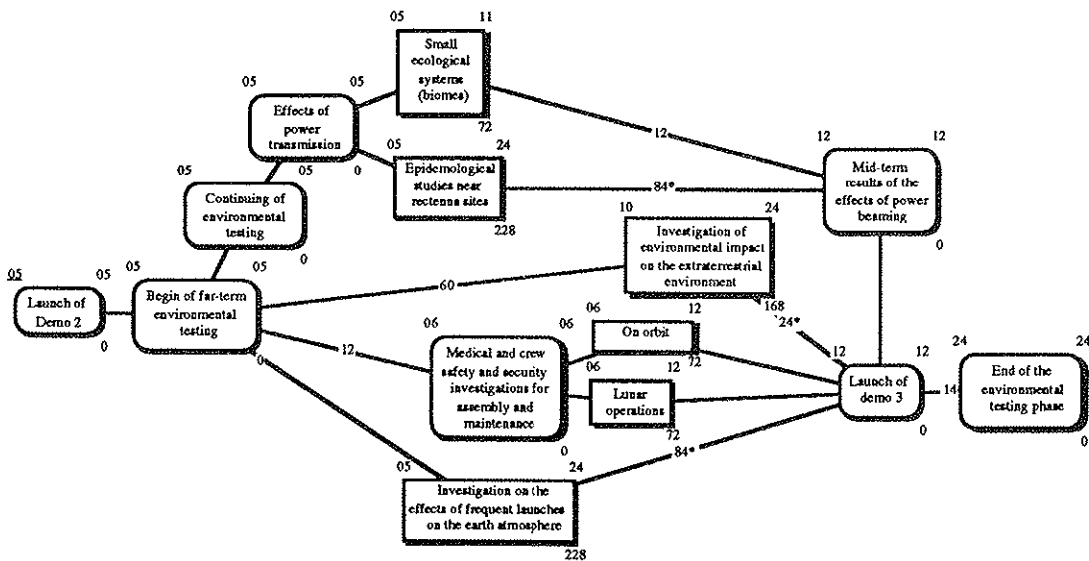

Figure 6.10 Long Term Environmental Tasks

References

- Asani, Y., et al., Combined effects of Anticholinesterase drugs and low-level microwave radiation., *Radiation Research*, 84, p496-503, 1980
- Barratt, M., *Extravehicular Activity for Orbital Construction: Medical and Human Factors Considerations*, ISU Advanced Lecture Series, 1992a
- Barratt, M., *The On-Site Medical Facility For Orbital Platforms*, ISU Advanced Lecture Series, 1992b
- Bernhardt, P. A., Price, K. M. and da Rosa, A. V., Ionospheric modification by rocket effluents, Argonne National Laboratory, 1980.
- Beverly, R.E., *Satellite Power System (SPS) - LASER Environmental Study*, Rockwell International Corporation, Contract No. M9M 8BNB-896662D, 1979.
- Cann, M., Adaptations of The Skeletal System, ISU '92 Space Life Science Textbook, Edited by: S. Churchill, ISU, Cambridge, Mass., 1992
- Chang, B. K., et al., Inhibition of DNA synthesis and enhancement of the uptake and action of methotrexate by low-power-density microwave radiation in L1210 leukemia cells., *Cancer Research*, 40, p1002-1005, 1980
- Cleave, Dr. M. ,RMS operator, and Lt. Col Jerry L. Ross, EVA crewman, Summary of STS Flight 61-B From: Experimental Assembly of Structures in EVA; The EASE Project from Flight 61-B, 1985. NASA Conference on Space Construction; Langley Research Center, Aug. 7, 1986 CP 2490
- David A.Kellermeyer, "Climate and energy: A Comparative Assessment of the Satellite Power System (SPS) and Alternative Energy Technologies, DOE/ER-0050,1980
- Davies, J., *Radiation and Health Care Issues for Space Exploration Initiative Missions*, ISU Life Science Core Lecture Notes, 1992
- Davis, K. A et al. Environmental Assessment for the Satellite Power System Concept Development and Evaluation Program-Electromagnetic Systems Compatibility (1981)
- Dietlein, L., *Space flight and the Telltale Heart*. *Am. J. Surgery*. v145:703-706, 1983.
- Ditton, V. R. Coupling to aerospace cables at microwave frequencies, IEEE EMC Symposium, San Antonio, TX pp 4BI c1-6 (1975)
- Duncan, L. M., and Gordon Wm. E., *Final Report - Ionosphere/Microwave Interaction Study*, William Marsh Rice University, Houston, Texas (1977).
- Edgerton, V. and Roy, R.R., Adaptations of Skeletal Muscle to Space flight., ISU '92 Space Life Science Textbook, Edited by: S. Churchill, ISU, Cambridge, Mass., 1992
- Effects of rockets exhaust products in the thermosphere and ionosphere Zinn, J. and Sutherland, C. D. 1980.
- Environment impacts of the satellite power system (SPS) on the middle atmosphere, NASA - Ames Research Center, 1980.
- Environmental assessment for the satellite power system-concept development and evaluation program-atmospheric effects, Argonne National Laboratory, 1980
- ERG 1980, "Prototype Environmental Assessment of the Impacts of Siting and Constructing a Satellite Power System (SPS) Ground Receiving Station (GRS)," Prepared for United States Department of Energy (contract number 31-109-38-5251); Environmental Resources Group, Los Angeles, CA
- Firmain, M. et al., *Microwave Sources for Power Transmission in Space*, Second International Symposium, SPS '91 - Power from Space, Paris/Gif-Sur-Yvette, 27.-30. August 1991, B7.3, p. 521-527.
-

Fly, T. S., et al., Heating characteristics of laboratory animals exposed to ten-centimeter microwaves, IEEE Trans. BME-11, 4, p123-137, 1964

Huyghe, R., and Ikeda, D. Dawn after Dark. 1991. Weatherhill Inc., New York)

Ikeda, D. The age of soft power and philosophy. Speech at Harvard University's John F. Kennedy School of Government, 26 September, 1991.

Information directorate, Dep. of National Health and Welfare, Canada, *Health aspects of radio-frequency and microwave radiation exposure, Part 1 and Part 2*, Environmental health Criteria document, 77-EHD-13, Nov., 1977 and 78-EHD-22, March, 1978

International Lunar Initiative, International Space University, Cambridge Mass., 1988.

Iwamoto , I., Sagawa, E, Denpakenkyusho Bulletin December 1982: 731-38

Juroshek. J. R. and Steele, F. K. Analysis of Interference from the Solar Power Satellite to General Electronic Systems

Koert, P. et al., *35 and 94 GHz Rectifying Antenna System*, Second International Symposium, SPS '91 - Power from Space, Paris/Gif-Sur-Yvette, 27.-30. August 1991, B8.1, p. 541-547.

Kosmo, J., *Design Considerations for Future Planetary Space suits* SAE 901428 Proceedings of the Twentieth Intersociety Conference on Environmental Systems, Williamsburg, VA. July 9-12, 1990.

Lai, H., et al., Low-Level microwave irradiation's affect central cholinergic activity in the rat., J. Neurochem., 48(1), p40-45, 1987

Lee, Jiin-lang, *Proceedings of the Workshop on Meteorological Effects of Satellite Power System Rectenna Operation and related Microwave Transmission Problems*, Conf-7808114, DOE/NASA, 1978

Lerner, E. J., *Electromagnetic hazards RF radiation: biological effects*, IEEE spectrum, 17, 12, p51-59, Dec, 1980

Letaw , J.R. , R. Silberberg, and C. H. Tsao. *Radiation Hazards on Space Missions*. Nature. v330:709-710, 1987.

Letaw, J.R., *Ionizing Radiation Hazards in Space*, ISU ' 92 Space Life Science Textbook, Edited by: S. Churchill, ISU, Cambridge, Mass., 1992

Lin, J. C., *The microwave auditory phenomenon*, Proc. IEEE, 68, 1, p67-73, Jan., 1980

Loftus, J., *Space: Exploration-Exploitation and the Role of Man*. Aviation, Space, and Environmental Medicine v57, no. 10 Section II, October, 1986 A69-77

Logan, J., *Operational Medicine and Health Care Delivery*, ISU ' 92 Space Life Science Textbook, Edited by: S. Churchill, ISU, Cambridge, Mass., 1992

Lu, S. T., Lotz, W. G., Michaelson, S. M., *Advances in microwave-induced neuroendocrine effect*, Proc. IEEE, 68, 1, p73-77, Jan., 1980

Manson, *Microwave Power Transmission System Study*, Vol. II, Intro., Organization, Environmental and Spaceborne Systems Analysis, NASA Lewis Research Center Report, Contract NAS 3-17835, (1976).

Margaret R.White, "Environmental Assessment for the Satellite Power System Concept Development and Evaluation Program-Non microwave Health and Ecological Effects", DOE/ER-0089,1980

McCormack, P., and D. Nachtwey. *Radiation Exposure Issues*. In: Space Physiology and Medicine Nicogossian, A.C. Huntoon, S. Pool. 2nd edition Lea and Febiger, Philadelphia. London 1989 pp. 328-348

Michaelson, S. M., *Microwave biological effect: An overview*, Proc. IEEE, 68, 1, p40-49, Jan., 1980

Michalson,S.M., *Human exposure to non-ionizing radiant energy-Potential hazards and safety standards*, Proc. IEEE, 60, 4, p389-421, April, 1972

- Murakami, A., *DENJIHA NO SEITAI KOUKA*, DENPAKENKYUJO KIHO, 28, p689-714, 1982
- Nagesuuri, K. Sr., et al., *Effect of chronic microwave radiation on T-cell-mediated immunity in the rabbit.*, International J. Biometeorol., 35, p92-97, 1991
- NASA Lunar Storm Shelter Conceptual Design, Eagle Engineering Inc. Houston, Texas, May, 1988.
- Newman, D., and Boyce, J. *Life Support and Performance Issues for Extra Vehicular Activity*, ISU '92 *Space Life Science Textbook*, Edited by: S. Churchill, ISU, Cambridge, Mass., 1992
- NINGEN-KANKYOUKEI ed. group ed., *NINGEN-KANKYOUKEI--NINGEN KINOU Data book--*, Chapter I, NINGEN TO GIJUTSU Co-Ltd., 1972
- NYSEG 1991, "Draft Environmental Impact Statement - Milliken Station Clean Coal Technology Demonstration Project," Prepared for United States Department of Energy, New York State Department of Environmental Conservation, and The Town of Lansing (document number 4964-001-370); New York State Electric & Gas Corporation, ENSR Consulting and Engineering, Binghamton, New York.
- O'Connor, M. E., *Mammalian teratogenesis and radiofrequency fields*, Proc. IEEE, 68, 1, p56-60, Jan., 1980
- Osepchuk, J. M. Interference problems and Space solar power. Lecture notes at ISU '92
- Peterson, L. and D.S. Nachtwey, *Radiological Health Risks to Astronauts from Space Activities and Medical Procedures*, NASA Technical Memorandum 102164, August, 1990.
- Proceeding of the workshop on stratospheric and mesospheric and Mesospheric impacts of satellite power systems (SPS), Argonne National Laboratory, 1979.
- Proceedings of the heavy lift launch vehicle tropospheric effects workshop, Argonne National Laboratory, 1979.
- Proceedings of the workshop on the modification of the upper atmosphere by satellite power system (SPS) propulsion effluents, La Jolla Institute, La Jolla, 1979.
- Silverman, C., *Epidemiologic studies of microwave effects.*, Proc. IEEE, 68, 1, p78-84, Jan 1980
- Svensson, B., Vogt, L., Herber, N. *EVA and Human Physiology*, Proceedings of the Third European Symposium on Space Thermal Control and Life Support System, Noordwijk, The Netherlands, 3-6 October, 1988 (ESA Sp-228, December 1988)
- Tell, R.A., *Microwave energy absorption in tissue*, Tech. Rep., PB-208233, Environmental Protection Agency, Feb., 1972
- Thompson, J., Brossel, K., and B. Webbon, *An Evaluation of Options to Satisfy Space Station EVA Requirements* SAE 861008 Proceedings of the Sixteenth Intersociety Conference on Environmental Systems, San Diego, CA. July 14-16, 1986
- Vallerand, A.L., R.D. Michas, J. Frim, and K.N. Ackles, "Heat Balance of Subjects Wearing Protective Clothing with a Liquid- or Air-cooled Vest", *Aviation, Space and Environmental Medicine*, v62, pp 383-391, (1991)
- Vanderploeg, J., *Space Occupational Medicine*, ISU Advanced Lecture Series, 1992
- Webb, J., Olson R., Krutz R., Dixon, g., Barnicott P. *Oxygen Toxicity During Five Simulated Eight-Hour EVA Exposures to 100% Oxygen at 9.5 psia*. Presented at the 18th Intersociety Conference on Environmental Systems, Williamsburg, VA. July 9-12 1990
- Yeande, S. S., *Microwave radiation and chordiazepoxide: Synergistic effects on fixed-interval behavior.*, Science, 203, 1357-1358
- Zimmerman, Bard, Feinberg. *Space Station Man-Machine Automation; A Trade-off Analysis* NASA JPL Special Publication CIT Feb. 15, 1985
-

7 Power Systems

The concept of electric power collection and transmission from space has been around since Peter Glaser first introduced solar power satellites (SPS) in the late 1960s. This chapter will describe the technologies associated with solar power systems which include power collection, conversion, transmission, and reception. The collection and conversion technologies include photovoltaic and solar dynamic systems. The transmission and reception systems include microwave and laser technologies. Major technical advancements since the 1970s along with increased global energy consumption have scientists and businessmen revisiting the concept of collecting solar energy and transmitting the power to electric energy users. This chapter will discuss both the developed and new technologies of a solar power system.

7.1 Solar to Electric Conversion

In this section technologies for power collection and power conversion have been reviewed. In particular photo-voltaic and solar dynamic systems have been examined in order to understand the differences in design and see how this affects the efficiency of the system, mass, cost and other factors which size the system. This has been divided into present technology and new or future technology so that trends can be identified and help us to understand where technology will be in 10-15 years time. Detailed designs of power collection and conversion systems are examined in the design example chapter where sizing of arrays, radiators etc has been calculated.

7.1.1 Photovoltaics

The most important element in photovoltaic systems is the solar cell. Nowadays there are many kinds of solar cells, but crystal silicon (c-Si) is the most popular for space use. Gallium arsenide cells (GaAs) were developed and have been qualified for space use in the middle of 1980's. They have a higher efficiency than silicon solar cells. But the cost of GaAs is much higher than that of c-Si, so careful trade-offs between the two types of cell are needed in designing a solar array. Many kinds of solar cells are under development, for example amorphous silicon (a-Si), indium phosphide (InP), copper indium diselenide (CuInSe₂:CIS), cadmium telluride (CdTe), etc. Moreover various research of multi-junction types have been performed in order to get more efficient solar cells, for example AlGaAs/Si, AlGaAs/CIS, GaInP/GaAs, etc.

Every solar cell can be characterized by its efficiency, cost, temperature characteristics, mechanical characteristics, degradation caused by radiation, etc. When designing a solar power satellite, we must investigate various parameters of solar cells based on the requirements of solar array wings such as power generation, operation temperature, mission life, spacecraft orbit, cost, etc. Particularly when the solar array structure of Solar Power Satellite is large scale and has a long-life like the NASA/DOE model, factors of cells such as conversion efficiency, density, endurance for radiation, etc. produce a powerful effect on the total weight and total cost of whole system.

In this section, the characteristics and the performances of the main types of solar cells and solar arrays are described first. Then the problems of large scale solar array construction and operation in space will be discussed. This consideration will be useful to understand the trade-off between photovoltaic systems and solar dynamic systems.

c-Si & a-Si (Silicon)

Almost all the solar cells used in space are silicon. This is the cheapest solar cell and they have been used for a long time in space. The research on single-crystal silicon is advanced in comparison with other types of cells and the actual efficiency is 24.2% (AM1.5 : Air Mass 1.5), this is very near the theoretical limit (27% - 30%). Recently polycrystalline silicon produced by cast method has also been developed. This type has high reliability and its electrical performance is stable for a long time but now the actual efficiency is about 17% (AM1.5).[Bailey, 1992]

For constructing many huge solar power satellites, silicon has a big advantage because there are large reserves of Si on both the Earth and the Moon. The general characteristics of c-Si are as follows.

- Low cost
- Flight proven
- Lower specific power
- Large degradation for strong radiation

The typical performances of c-Si for space use mounted on polyimide film are as follows.

Cell efficiency	(@28°C BOL)	14.5%
Panel efficiency	(@28°C BOL)	11.2%
	(@80°C EOL)	6.5%
Weight	(@80°C EOL)	119 W/kg
Area	(@80°C EOL)	88 W/m ²
Cost		\$700 /W
Radiation degradation		0.86

BOL : Beginning of Life EOL : End of Life

(Conditions : After 10 years in a 840 km 80 deg. inclination orbit, Cerium-doped microsheet grade Z (CMZ) cover glass, unframed panel.)[Nozette, 1992]

From the point of low cost and light weight, a-Si mounted on thin film has high performance. The characteristics of a-Si are as follows:

- Mass produceable
- Lightweight and very compact stowed size
- Better operation at high temperature
- Very light absorbent
- Excellent tolerance to radiation dose
- Little degradation with temperature
- Degradation of its efficiency by light

The typical performances of a-Si cells are as follows:

Cell efficiency	(@28°C BOL)	10.3%
Panel efficiency	(@28°C BOL)	8.3%
	(@80°C EOL)	6.8%
Weight	(@80°C EOL)	613 W/kg
Area	(@80°C EOL)	92 W/m ²
Cost		\$150 /W
Radiation degradation		0.96

(Conditions : After 10 years in a 840 km 80 deg. inclination orbit, CMZ cover glass, unframed panel.)

For the large scale SPS in Geosynchronous Earth Orbit (GEO), like NASA/DOE model, a-Si can reduce total mass and cost. Because radiation degradation of a-Si is lower than that of c-Si, a-Si has a lot of merits in designing a long-term commercial Solar Power Satellite in GEO.

GaAs (Gallium Arsenide)

The efficiency of individual cells has reached 25.7%(AM1.5) which is near the theoretical value (27%). The efficiency of this cell is higher than that of Si, but the cost is much higher than that of Si.

The typical performances of GaAs cells mounted on polyimide panel are as follows.

Cell efficiency	(@28°C BOL)	18.0%
Panel efficiency	(@28°C BOL)	13.4%
	(@80°C EOL)	11.7%
Weight		126 W/kg
Area		158 W/m ²
Cost		\$1400/W
Radiation degradation		0.92

(Conditions : After 10 years in a 840 km 80 deg. inclination orbit, CMZ cover glass, unframed panel.)

InP (Indium Phosphide)

This material has the advantage that its radiation degradation is very low. Also, the theoretical efficiencies are high, with laboratory cells demonstrating about 19% (AM0 : Air Mass 0) efficiency at this time. Material costs are very high and resources of Indium are rare at this time.[Ralph, 1989]

The typical performances of InP cells mounted on a polyimide panel are as follows:

Cell efficiency	(@28°C BOL)	11.8%
Panel efficiency	(@28°C BOL)	8.9%
	(@80°C EOL)	5.8%
Weight		100 W/kg
Area		79 W/m ²
Radiation degradation		0.94

(Conditions : After 10 years in a 840 km 80 deg. inclination orbit, CMZ cover glass, unframed panel.)

CuInSe₂ (Copper Indium Diselenide)

This material can be a thin-film cell. The advantages of thin-film cells are: high radiation tolerance, high specific power, large area solar cells with integral series interconnections, flexible blankets, large body of array manufacturing experience and low cost. The disadvantages of thin-film cells are: lower efficiency, lack of spacecraft experience and no light weight substrates have been produced for space use.

As a feature of CuInSe₂, the bandgap is 1.0 eV, which is on the low side of the AM0 efficiency maximum, but nearly ideal for the bottom cell of a multi-bandgap cascade structure. An efficiency of 10.4%(AM0) has been achieved by Arco Solar (now Siemens Solar). An efficiency of 12% has been predicted in the near term.

The absorption constant of CuInSe₂ is extremely high, allowing the possibility of cells as thin as one micron. Existing cells consist of a layer of the active CuInSe₂, typically about 3 microns in thickness. So, the current specific power is relatively high, 7.0 kW/kg (does not include coverglass).[Landis, 1989]

CdTe (Cadmium Telluride)

CdTe is also being extensively studied for thin-film cells. The bandgap of CdTe is 1.5 eV and is very well matched to the solar spectrum.

The best CdTe cells to date have been manufactured by an atomic layer epitaxy process that uses a graded junction to enhance current collection. These cells have an AM0 efficiency of about 11.2%. A production run of 20 kW of large area CdTe modules was done for SERI by Photon Energy Co., using electrode posited CdTe and a thinned CdS window. The best efficiencies for modules of this design are about 9.8% (AM0).[Landis, 1991]

The typical electric characters of solar cell for space use is shown in Figure 7.1 and Figure 7.2.[Nozette, 1992]

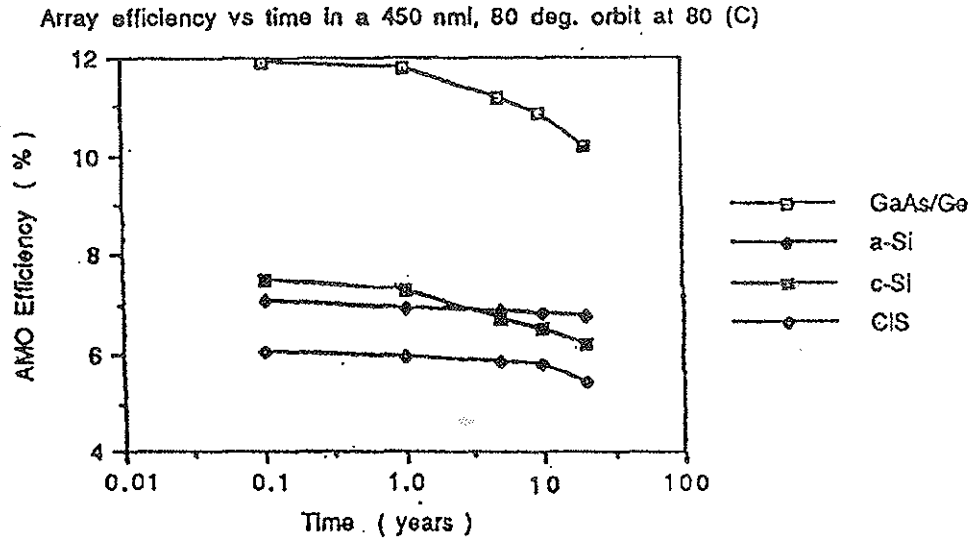

Figure 7.1 Array Efficiency vs Time [Nozette, 1992]

SOLAR ARRAY POWER vs TEMPERATURE

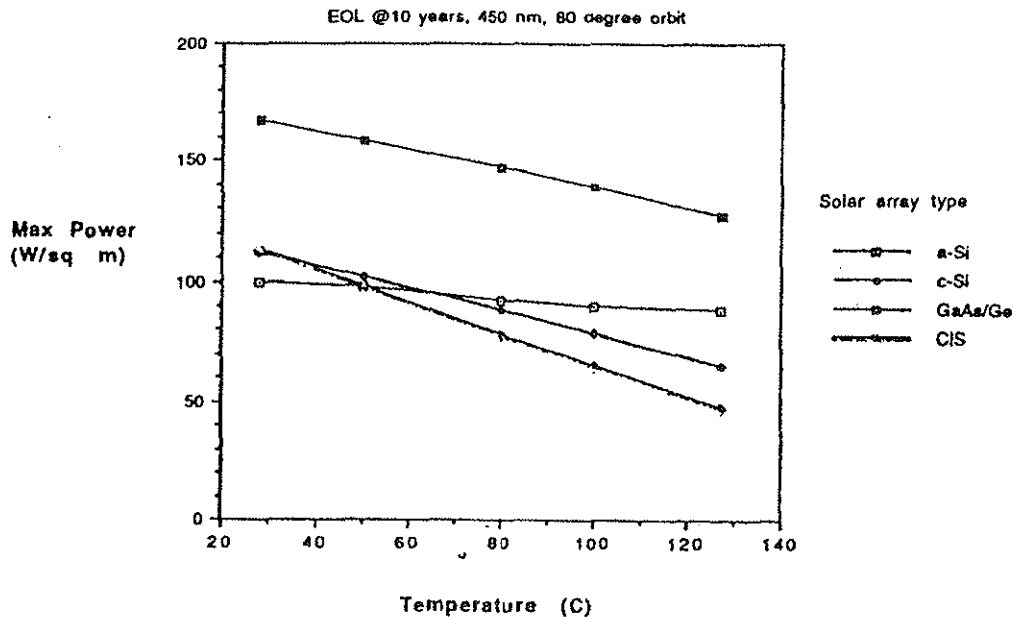

Figure 7.2 Array Power vs Temperature [Nozette, 1992]

Thin-film Cascades

An important technology for the production of high-efficiency thin film arrays is the ability of thin films to be produced in multi-bandgap "cascade" structures. In the cascade structure, short wavelength (high energy) photons are absorbed in a high bandgap material on the top of the solar cell. The high bandgap material is transparent to longer wavelength (low energy) photons, which pass through and are absorbed by a second layer consisting of a photovoltaic material with lower bandgap. In a current-matched two-element cascade, the efficiency can be approximated, as equal to the top cell efficiency plus half the bottom cell efficiency. The best currently demonstrated thin-film cascade, reported by Siemens Solar, uses an amorphous silicon top cell on a CuInSe₂ bottom cell. The achieved efficiency is 12.5% (AM0).

Solar Array Paddle

For the photovoltaic system, parameters of structures to support solar cell array are as important as for solar cells. Generally the structure is called solar array paddle or solar array wing and classified by three types, that are rigid paddle, semi-rigid paddle, and flexible paddle.

The rigid paddle is the cheapest type and has the highest-reliability. Usually it consists of aluminum-honeycomb sandwiched by sheet of aluminum (Al) or Carbon Fiber Reinforced Plastic (CFRP). Lightweight Lattice Panel (LLP) which has lattice structure made by CFRP is the lightest paddle in the rigid paddle. When the power level is lower than about 5 kW, rigid paddle is lighter than the other types. The power to weight ratio of this type is about 30 W/kg in the case of 5kW class with using Si cells. This paddle was employed by various satellites till now and is recently employed by INTELSAT-VII.

The semi-rigid paddle consists of CFRP lattice and CFRP sheet tensioned in the lattice. The weight is almost same as that of LLP and is employed by Japanese Earth Resources Satellite - 1 (JERS-1), Engineering Test Satellite - VI (ETS-VI), etc.

The flexible paddle is suitable for large-power use in space. It is easy to fold in the fairing of the carrier. The weight of this paddle is lighter than the rigid paddle in the case of large power (more than 5 kW). This paddle consists of a thin blanket containing wire harness and usually is extended by a mast mechanism on orbit. When the power level is below 10 kW, the weight of the mechanism for holding and expansion is constant and is about 100 kg to 150 kg. Therefore, the higher is power, the bigger is the ratio of power to weight. There are two ways to expand this paddle. One is roll-type method and the other is fold-type method. The typical example of the roll-type method is the paddle of the Hubble Space Telescope which was launched in 1990. The power generation of this paddle is 4.8 kW(BOL), and the weight is 270 kg. The ratio of power to weight is 17.7 W/kg. The size of this paddle in expansion is 11.82 m x 2.83 m (without its mechanism), the ratio of power to area is 143 W/m². The typical example of the fold-type method is the paddle of Space Station Freedom (SSF). 8 cm x 8 cm Si cells are mounted on this paddle and the generation power is 27.8 kW. The ratio of power to weight is 43 W/kg (BOL) and ratio power to area is 95 W/m² (BOL). [Bailey,1992]

Problems of Large Scale Solar Array Wing

When the size of the solar array is large and its generation power is high, we are faced with a lot of problems with which we have not had experience until now. In this case, if we use current technology for the solar array paddle, we must use a high-voltage solar array to reduce transmission loss between solar cells and power transmission area in the spacecraft. It is ensured that the limit of operating voltage of solar array is determined by plasma induced discharge. The voltage threshold for breakdown is dependent on the plasma density and it may be about several hundreds volts in Low Earth Orbit (LEO). The reason for this phenomenon is that the exposed interconnectors of high voltage biased solar cells make complicated electrical fields near the boundary between interconnectors and coverglasses, which are insulators. Therefore this may not be serious in GEO. Another way to reduce the transmission loss is to employ an Alternating Current (AC) system. In this case, solar array must contain some inverters and this may reduce the power density of solar array.

In GEO, there is a problem of charge-up to several kilovolts on the surface of the spacecraft caused by high-energy particles. It is considered that this phenomenon may induce arc discharge and the electrical function will suffer from the discharge. In the case of the current satellites, it is

well known that bonding is effective for protecting from charge-up. But it is not sure for large scale structure that there is no problem with bonding.

In the design of a large scale solar array, we must pay attention to the direction of the current loop in the solar array. Because the high current loop induces strong magnetic field, we must design the direction of current loop not to influence attitude control of the spacecraft and not to produce Electric Magnetic Interference (EMI) problems.

In LEO, high voltage solar array with Direct Current (DC) output collects plasma particles which produces leakage current, ion drag, plasma induced discharge, and contamination caused by sputtering of interconnectors material. These phenomena are dependent upon the array voltage and plasma density.

7.1.2 Solar Dynamic Systems

Introduction

This section will present an overview of solar dynamic technology as a method for providing power to an orbiting satellite. Solar Dynamic Systems (SDS) work by using a solar concentrator to collect solar radiation and focus it on a receiver to heat up the working fluid. A power conversion unit based usually on either the Brayton, Stirling or Rankine thermodynamic cycles converts the heat energy into electrical energy which then feeds it the satellite. First of all a short summary of the major elements of a solar dynamic system is provided which shows how the system operates. This includes a short description on the thermodynamic cycles. Next the heritage of solar dynamic systems will be discussed. Although there is no known (non-military) solar dynamic system that has been tested in space, there are a number of ground tests that have been performed which help to demonstrate the feasibility of this technology. Finally, future plans for solar dynamic systems will be briefly discussed. This includes the Space Station Freedom SDS which will increase the power generation from 45 kW to 75 kW and the Japanese Space Flyer Unit.

Solar Dynamic Systems Elements

In this section a review of the main elements of a solar dynamic system will be given. A solar dynamic system (SDS) consists of the following elements:

1. a concentrator used to collect the solar radiator and focus it on a receiver
2. a heat receiver used to convert the solar energy to heat energy and to store energy for eclipse
3. a power conversion unit used to convert the heat energy to electrical energy
4. a heat rejection element used to reject any waste heat to deep space

Other elements required include integration hardware to attach the solar dynamic system to the satellite, electrical control equipment, pointing equipment to accurately point the collector at the sun and a power distribution system.

Concentrators

Concentrators collect solar radiation using a large reflector system and focus it on the receiver. Different designs exist for collector assemblies which make use of standard reflector systems, e.g., Cassegrain or offset Parabolic mirrors with the design chosen depending on the overall system.

Figure 7.3 shows examples of four concentrator configurations. The first is a plane receiver with plane reflectors at the edges to reflect additional radiation onto the receiver. The concentration ratio is relatively low with a maximum value of less than 4. The second shows a parabolic reflector which could be a cylindrical surface or a surface of revolution which have much higher concentration ratios. The third shows a Fresnel reflector which uses a set of flat reflectors on a moving array. Alternatively, the facets of the reflector can also be individually mounted and adjusted in position as shown in the fourth example.

The concentration ratio, C , is defined as the ratio of the area of aperture A_a to the area of the receiver A_r .

That is $C = A_a / A_r$

This ratio has an upper limit that depends on whether the concentration is a three dimensional concentrator such as a paraboloid or a two dimensional concentrator such as a cylindrical parabolic concentrator. As the concentrator ratio increases, the receiver temperature increases and imposes an increasing requirement for precision in optical quality and positioning of the optical system.

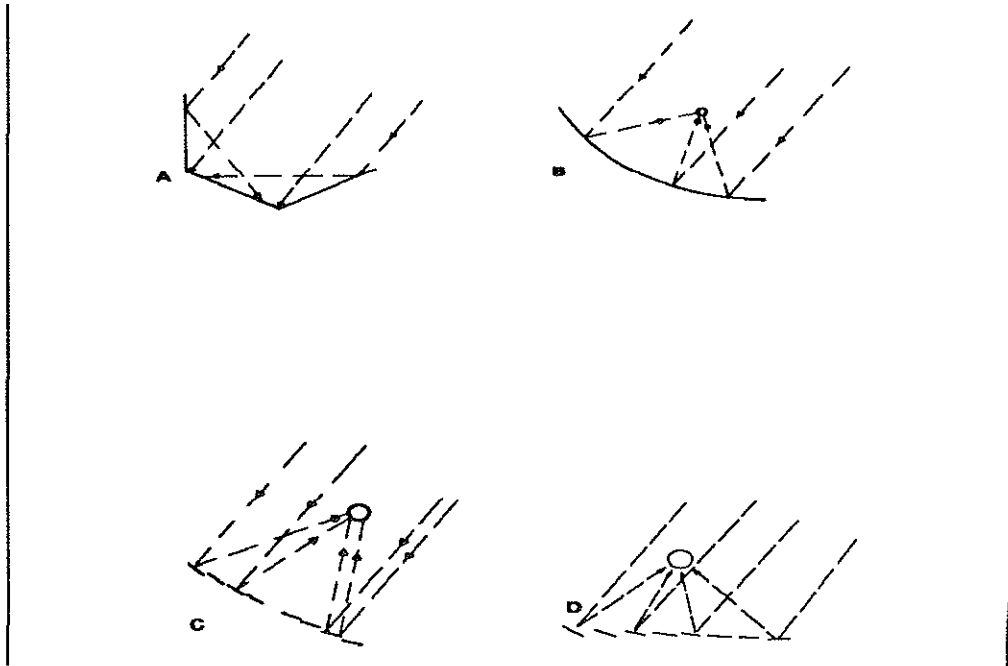

Figure 7.3 Possible Concentrator Collector Configurations: (a)Plane Receiver with Plane Reflectors (b)Parabolic Concentrator (c)Fresnel Reflector (d)Array of Heliostats [Duffie,1980]

Figure 7.4 shows the relationship between the concentration ratio and the temperature of receiver operation for ground based systems. The shaded range corresponds to collection efficiencies of 40-60 % and represents the usual range of operations.

The maximum concentration ratio is limited by the optics and for circular concentrators is less than 10^4 .

Since the collectors focus light on the receiver, accurate pointing of the mirror with respect to the sun to the order of 0.1° is required. This requires some kind of pointing mechanism. Previous proposals have put forward combinations of gimbals and actuators. It is also possible to use the satellites attitude control system to point the collectors but this can have a negative impact on other requirements of the satellite.

A number of proposed Solar Dynamic Systems are shown in Figure 7.5 (a, b and c). These show the physical dominance of the solar concentrator as well as the large size of the radiators.

Receivers [Eguchi K,1992]

The receiver is located near the focal point of the concentrator. The solar energy is used to heat up the working fluid which can either be liquid or gaseous. Because the satellite will be in eclipse for at least part of its orbit (unless it is in sun-synchronous orbit), energy needs to be stored to provide the required energy during the dark periods of this orbit. One method of doing this is to surround the receiver with canisters containing an eutectic salt mixture and use its heat of fusion as the energy storage method. Thus when an eclipse occurs the salt mixture changes state releasing heat and providing power. This greatly increases the mass and hence cost of the receiver.

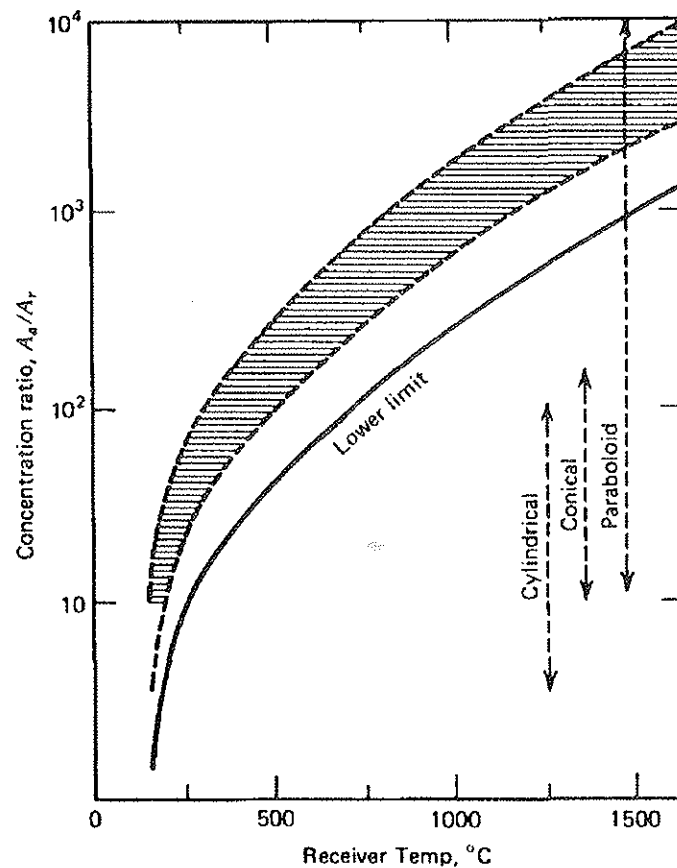

Figure 7.4 Relationship Between the Concentration Ratio and Temperature of the Receiver Operation [Duffie,1980]

Power Conversion Unit

The power conversion unit converts thermal energy into mechanical energy which is then be converted into electrical energy using a generator. SDS based on heat engines use closed-cycle conversion systems of the Rankine, Brayton and Stirling type. The energy is extracted from the working fluid by a mechanical device, usually either a turbine or piston.

In order to compare the merits of different dynamic power cycles it is useful to compare the efficiency and peak cycle temperature as shown in Figure 7.6 This shows as the peak cycle temperature is increased the efficiency of the cycle also increases. However as the temperature increases so does the use of non-conventional materials and hence the cost of the system. This figure is for terrestrial systems and assumes a fixed sink temperature.

Rankine Cycle

This thermodynamic cycle uses a two phase working fluid in a closed cycle and is shown in Figure 7.7. The liquid phase is pumped to operating pressure, vaporized and expanded across a turbine. This turbine drives a generator to produce electric power. The discharge vapor from the turbine is condensed and the waste heat is rejected. If an organic fluid such as toluene is used as the working fluid, the discharge from the turbine is still superheated. A regenerator is incorporated in this cycle to remove the superheat and transfer the heat to the high-pressure liquid before entering the vaporizer.

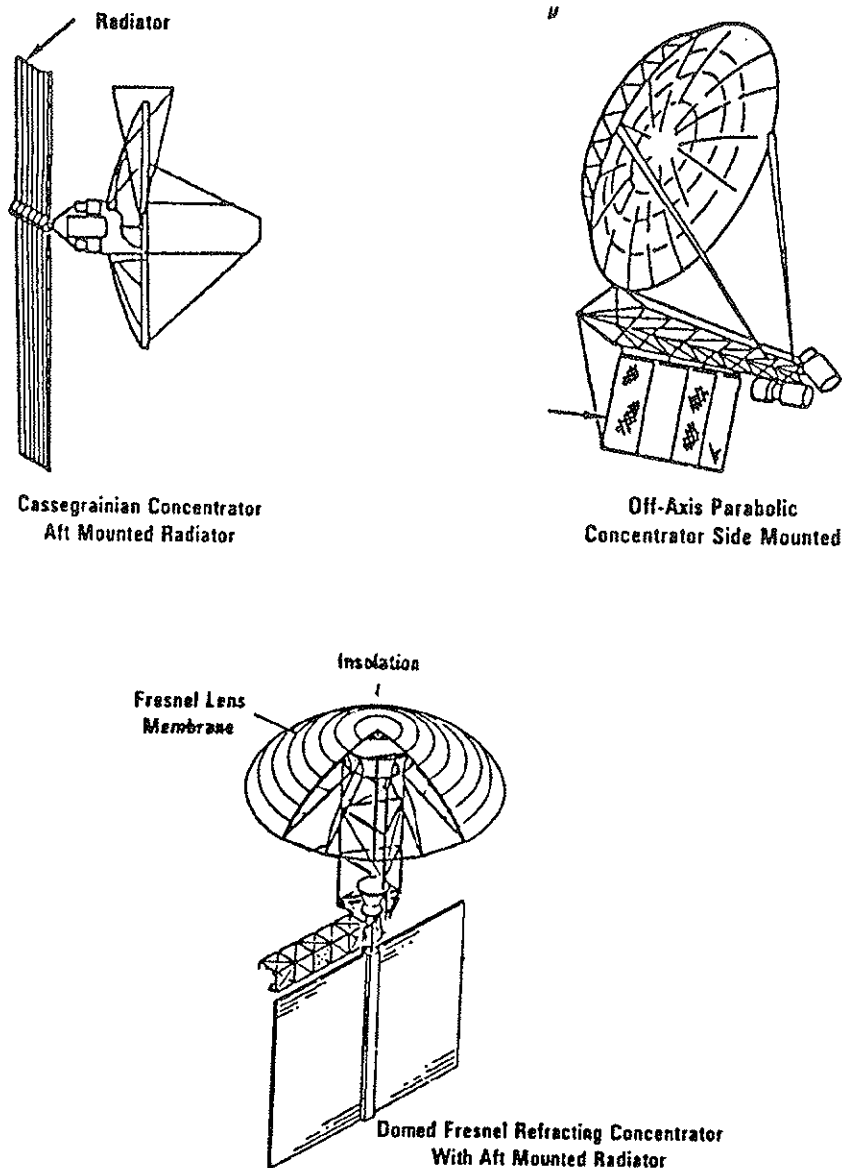

Figure 7.5 Possible Satellite Configurations with Solar Dynamic Systems

Brayton Cycle

The Brayton cycle, shown in Figure 7.8, is a power producing thermodynamic cycle that functions by the mechanical compression of a gas, further heating of the gas at constant pressure, expansion of the gas to produce mechanical energy, and rejection of the waste heat at constant pressure. This operates with a gaseous single-phase working fluid but is similar in principle to the Rankine Cycle. Experimental systems have used helium-xenon mixture to minimize compressor power consumption and enhance heat transfer.

Stirling Cycle

This is a closed cycle reciprocating piston engine that uses helium or hydrogen as its working fluid and is shown schematically in Figure 7.9. Heat energy is converted into electrical energy using a free-piston type engine integrated with a linear alternator. The regenerator is used as a heat exchanger to minimize waste heat and therefore increase thermal efficiency.

A number of technological developments are required in order to develop space heat engines. These are listed in Table 7.1.

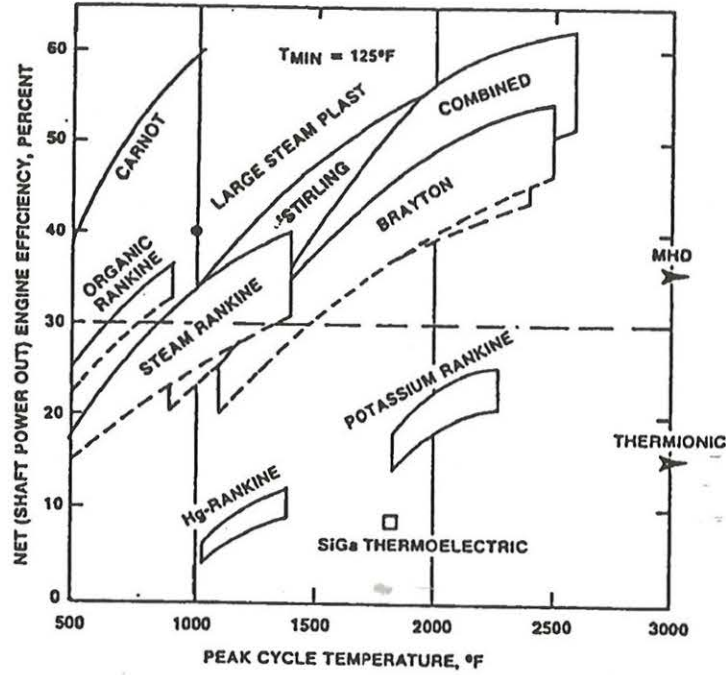

Figure 7.6 Thermodynamic Efficiencies of Terrestrial Heat Engines [Kunihisa,1992]

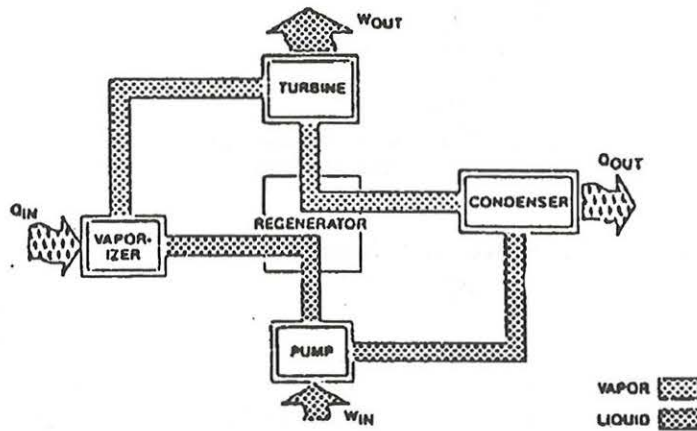

Figure 7.7 Organic Rankine Cycle Power System [Kunihisa,1992]

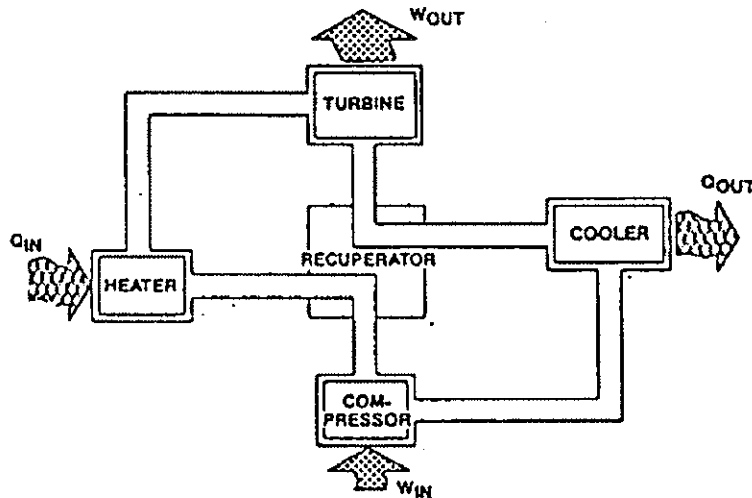

Figure 7.8 Closed Brayton Cycle (CBC) Power System [Kunihisa,1992]

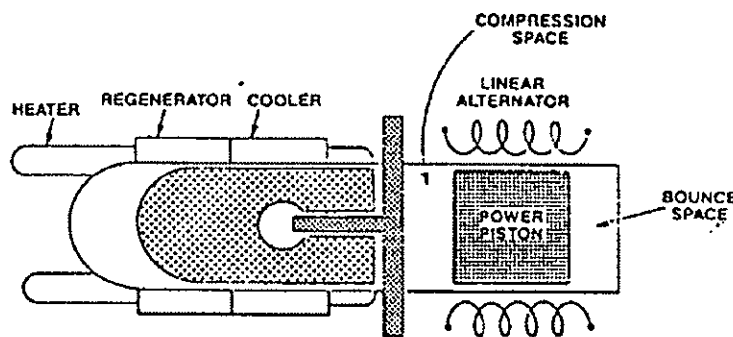

Figure 7.9 Stirling Engine with Linear Alternator [Kunihisa,1992]

Table 7.1 Technical Development Required In Thermodynamic Power cycles [Kunihisa,1992]

BRAYTON	ORGANIC RANKINE	FREE PISTON STIRLING
High Temperature Level (Storage media and container materials)	Stable Working Fluid	Dynamics(vibration, stability)
Compressor Efficiency	Two Phase Flow Control	Linear Alternator
Recuperator Weight	Turbine Efficiency	Non-Contact Sealing
Gas bearings	Fluid Bearings	

Heat Rejection Assembly

To reject any waste heat left over from the PCU, a radiator is required. The amount of energy radiated into space is proportional to the temperature to the fourth power, so the higher the temperature the more energy is radiated into space, i.e., the higher the Watts/m². However the efficiency of the SDS is dependent on the ratio of the turbine inlet temperature and the radiator outlet temperature, with the higher the ratio the more efficient the system will be. Thus although it is possible to reduce the radiator size by increasing the temperature within the radiator, it is at the expense of the thermodynamic efficiency. At 293 K the heat rejection capability of a radiator in orbit is ~200-250 W/m².

The waste heat can be transferred from the PCU and other electrical equipment by a pumped liquid loop to the radiator which radiates the heat to space. The choice of method depends on thermal cycle and system trades-offs.

Interface Structure

An interface structure is required to mount the SDS to the satellite. The exact structure will depend on the satellite but it will need to maintain the accurate alignment between the concentrator and the receiver as well as the alignment between the sun and the concentrator. Because pointing of better than 0.1° is required a 2-degrees of freedom pointing mechanism will be required.

Electrical Equipment

The electrical equipment contains all of the controls for the SDS module. This controls the pointing controllers, PCU, and the pump motors.

Ground Demonstrations

Past and Present Systems

Although there is no experience of operating a solar dynamic system in space there is an extensive database of operating these systems on the ground. This helps build confidence in the development of Space Heat engines.

Brayton Cycle Systems

Closed Brayton systems represent a mature technology, benefiting from a long history of closed cycle system development and an extensive technology base provided by the open cycle gas turbine industry. Brayton cycles use gas as the working fluid and therefore are unaffected by the micro-gravity environment in space. NASA have a long history of developing their heat engines for demonstration the necessary technologies, which are summarised below. [Harper,1989]

1962	3kW	demonstrator
1963	10kW	demonstrator (engine A)
1965	10kW	demonstrator (engine B)
1972	100kW	nuclear powered
1976	1.3kW	radioisotope-powered satellite

Stirling Engine

A Space Power Demonstrator engine (SPDE) has been developed by NASA which generated 25 kW using a dynamically balanced opposed-piston Stirling engine at a temperature ratio of 2. This gave an efficiency of ~ 22% and was operated at a temperature of 650 K.

Future Ground Systems

High Temperature Stirling Space Engine

Presently a space Stirling engine based on the SPDE but with an increased operating temperature of 1050 K is being constructed with the eventual aim of constructing an engine operating at 1300 K.

Space Station Ground Demonstrator

In order to reduce the risk to the Space Station Freedom solar dynamic program and to reduce costs of testing, NASA is funding a 2 kW Solar Dynamic Demonstrator. This will test a complete, space configured, solar dynamic system with integral thermal energy in a vacuum chamber. Previous demonstrations have concentrated on testing individual components. This will test the whole system and provide an extensive database of system and component tests.

The demonstrator is a scaled down version of that planned for the Space Station producing 2 kW and is based on the closed Brayton cycle. Assuming 20 kW of energy from the sun, the power engine input, after collection and heat losses, is about 8.0 kW which produces 2 kW in the net power output.

Dynamic Isotope Power System, DIPS

The DIPS technology program was aimed at developing the CBC for converting heat engine from an isotope heat source to electrical energy in the range 1-10 kW range. The engine developed in this program is being used in the 2 kW ground demonstration.

Future Space Applications

Space Station Freedom (SSF)

For the SSF, it is proposed to use a power system based on a Solar Dynamic System, to supplement the power during the second phase of the program, as shown in Figure 7.10.

The receiver will be 1.8 m in diameter with a 3 m height and a weight of 1800 kg. In ground the test receiver had a 50 cm in diameter with a 70 cm height and only 100 kg. The radiator has 2 panels with 456 m² and the heat transfer performance has already been verified on Earth. The Solar collector concentrator shown in Figure 7.11, is composed of 19 hex panels with 456 facets total. The area of this concentrator is about 193.3 m² with an efficiency of 81%.

Space Flyer Unit (JETRO,1991)

Another Solar Dynamic Power generation system was designed and planned by the Japanese Institute of Space and Astronautical Science (ISAS), for a 1994 experiment on the unmanned Space Flyer Unit (SFU). In this mission the power generated will be about 2 kW which will be used to power MPD arcjets to change the SFU orbit. A non-lubricated Stirling engine and a linear induction generator are used for converted thermal energy to mechanical and then to electrical energy. The Thermal storage system receives thermal energy from the collector, stores it and then supplies the Stirling Engine with the necessary energy during eclipses.

The energy collected by the solar collector is changed to thermal energy on the inner surface of the receiver and transferred to the hydrogen gas working fluid of the Stirling engine. Then, in the recuperator, this energy is used for expansion work in the Stirling cycle. The linear induction generator consists of permanent magnets on the moving power pistons and winding coils. The AC current is then induced in stationary coils.

The efficiency of this Stirling engine generator is 31%. The efficiency of the linear induction generator is around 87%. Therefore the overall system efficiency is about 25%.

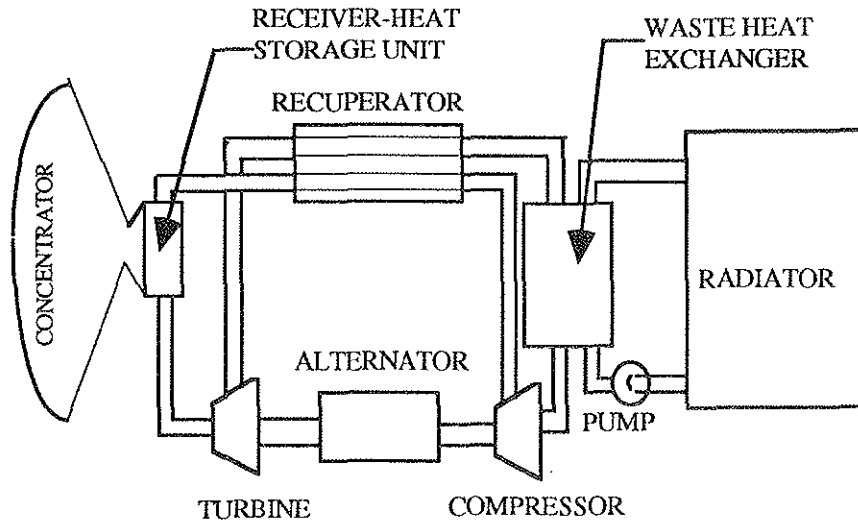

Figure 7.10 Schematic of Space Station Freedom Proposed SDS [Dustin,1992]

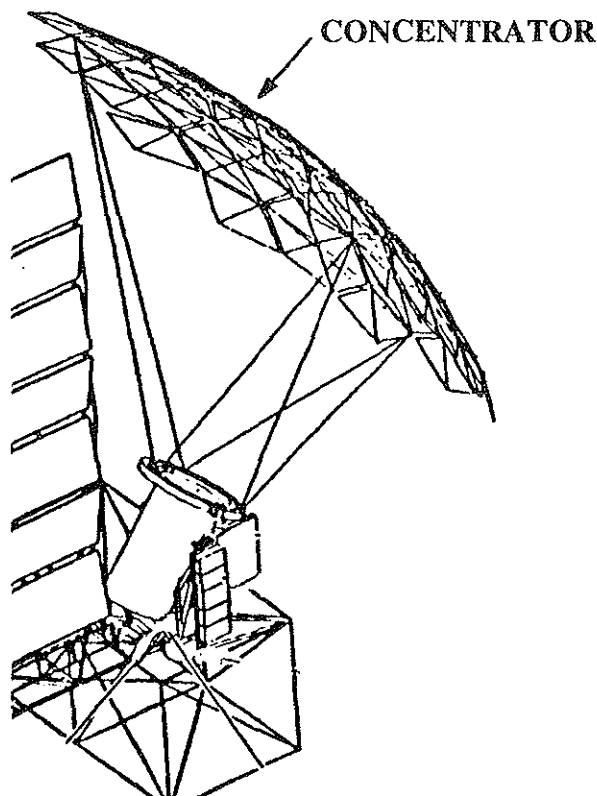

Figure 7.11 The SDS for Space Station Freedom [Dustin,1992]

Small Satellites

If we can provide small satellites (communications, Earth observing) with Solar Dynamic System (SDS) - these satellites will have a longer lifetime and also lower amortized costs. SDS is less susceptible to radiation effects than photovoltaic panels and that translates into long term life and operational flexibility. At the present moment SDS are too heavy for small satellites, and it is necessary to also develop a high efficiency, low mass auto-deployable concentrator.

7.1.3 Comparison of Photovoltaics with Solar Dynamic Systems for Power Collection

This section provides an overview of the two main competing technologies for collecting solar radiation and converting it to electrical energy. Its purpose is to indicate the type of trade-offs that must be performed when designing a solar satellite power source.

Efficiency

One of the main technical design drivers is the efficiency of the collection process since this will determine the overall mass of the system used, i.e., the higher the efficiency, the smaller the mass. Photovoltaic systems which are presently used for solar arrays on satellites, are typically 10-15% efficient using Silicon solar cells with GaAs cells being developed being 18-20% efficient. In the long term it is possible to increase the efficiencies up to 30% using tandem cell technology but this considerably increases the costs.

Solar dynamic systems (SDS) tested on the ground have typical efficiencies of 25-30 % depending on the cycle, used with up to 40 -50 % predicted in the longer term.

Since SDS are a lot more efficient than photovoltaics then for generating the same power, the area required to collect the solar radiation can be considerable reduced..

Space Qualification

Photovoltaics based on silicon solar cells have a very good space heritage having been used for solar arrays for the last 20-30 years. GaAs cells have been flown on satellites but mainly on an experimental basis to test the characteristics of these cells in a space environment.

Solar Dynamic Systems have not been used in space although there is an extensive ground database on the use of certain type of heat engines in particular the Brayton Heat Engine has been tested extensively by NASA. Stirling Heat Coolers as opposed to Stirling Heat Engines, i.e., they are used to cool equipment, have been flown on a number of space missions. A number of space qualification missions would be required before an operational mission could be flown using space heat engines.

Costing of System

Photovoltaic systems are very expensive based on present manufacturing techniques. Using more efficient GaAs and tandem cell reduces the number of solar cells required to produce a given power but increases the individual solar cell cost and so a trade-off must be performed as to the lowest.

SDS are inherently less expensive since they use mirrors in the form of concentrators to collect the radiation. For example for the Space Station Freedom it has been estimated that the SDS recurring cost would be half that of an equivalent photovoltaic system although there will be extra cost for the initial design and development of a SDS system. This is shown in Figure 8.12. The data is based on current 1875 kW photovoltaic and 25 kW Solar Dynamic power modules in a balanced station configuration.

Orbit Selection

For power collection, the orbit has two main impacts on the selection of either photo-voltaic or Solar dynamic systems. These are the radiation environment and the orbit itself.

The radiation environment varies with the orbit the satellite is in. For Low Earth Orbit, the radiation dose is small but at geostationary and inter-mediate (especially orbits like Molniya) orbits, the radiation dosage can be very high.

For photovoltaic systems, the effect of radiation varies with the type of solar cell being used. At geostationary orbit the impact is quite high for Si solar cells leading to between 10-20% overall power degradation. However new cell technology like InP and GaAs is inherently less radiation susceptible and therefore has very little radiation degradation.

For solar dynamic systems there are no solar cells and therefore there is no power degradation.

In LEO there is a problem due to atmospheric drag which reduces the satellite altitude. This requires regular orbit compensation manoeuvres which increases the overall mass of the system. Since Solar dynamic systems are inherently more efficient than photovoltaics systems, less area is exposed (even after allowing for the large radiators required to reject the waste heat) requiring less orbit correction to be provided.

Other Factors

Pointing

Solar dynamic systems have a pointing requirement of 0.1° in order to obtain the high concentrator ratios necessary. This is a lot higher than photo-voltaic array type systems which can handle de-pointing typically of $1-2^\circ$ with little impact on the power output.

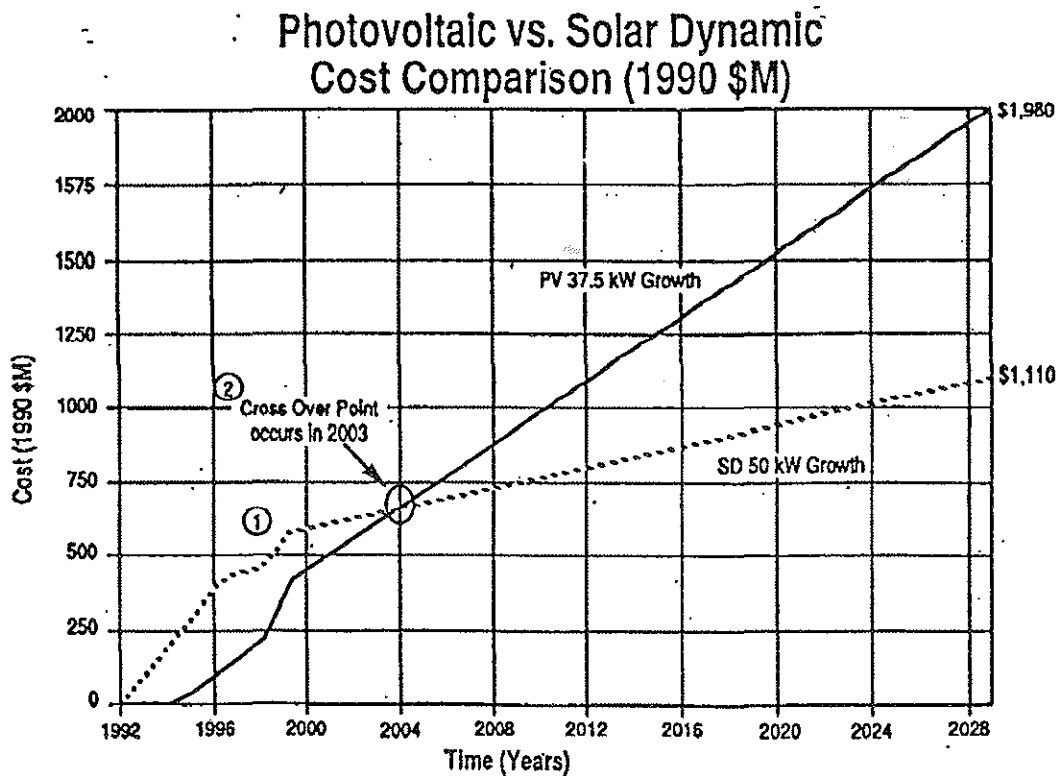

Figure 7.12 Cost Comparison for Space Station Freedom Power Generation [Fordyce,1992]

Heat Rejection

In the process of generating heat energy, a SDS produces waste heat which must be rejected using some kind of radiating surface. For large systems, a heat transport system using pumped liquid or two-phase fluid loop is necessary to transport heat to the large radiator that is required. For a photovoltaic system no waste heat is produced and therefore no radiator is required making it a simpler system.

7.1.4 New Technologies

This section will cover power collection technologies different from the technologies having to do with the photovoltaic and solar dynamic conversion systems. Thermoelectric and thermophotovoltaic theory will be explained. We will also describe a new type of solar dynamic generator. Special attention will be given for describing the actual state of these technologies and their effect on the implementation of any large scale SPS. Additional subsystems involving promising technologies will be investigated. For example such a system is the liquid droplet radiator.

Thermoelectric Generator Concept

If two semiconducting materials connect a high and a low temperature reservoir, then due to this temperature difference an electric current is generated. The phenomenon behind this power production is known as the Seebeck effect. A schematic look at this system is presented in Figure 7.13. Unfortunately, this single-stage generator delivers very low output voltage. A simple way of overcoming this limitation is to have a multistage generator by staging a series of couples. Then the output voltage is N times the voltage of one couple where N is the number of couples. This implies that the electrical power output and the thermal input needed in the hot reservoir increases linearly with N .

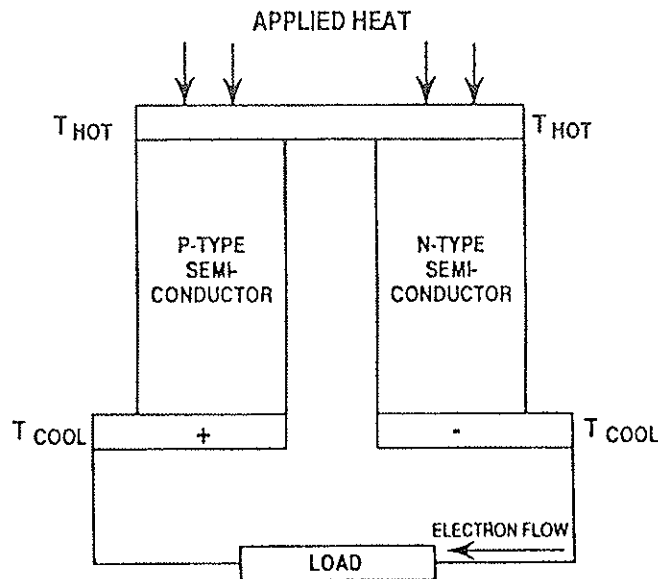

Figure 7.13 Model of a Thermoelectric Generator [Angrist, 1982]

To have a better feeling of his technology's potential, let's summarize the relevant quantities that a designer would be interested in knowing in order to accomplish a specific task. The actual calculations can be found in. [Angrist, 1982] Let's consider a thermoelectric generator that operates between 27 °C and 327 °C. The n-type material is made of 75% of Bi_2Te_3 and 25% of Bi_2Se_3 while the p-type is 25% of Bi_2Te_3 and 75% of Sb_2Te_3 . The design for maximum power will able an output of 1.48 V with a current of 23.2 A. In this case the power delivered is 13.04 W. The thermal efficiency for this generator is 11.03%.

This technology has up to now be used for radioisotope thermoelectric converters. It has provided power independently of solar flux. This has been particularly advantageous for deep space probes. This concept could nevertheless be used for generating energy from the sun by using the solar radiation as the heat source for the hot reservoir. However, we should remember that the radioisotope thermoelectric generator have two main disadvantages which are the high cost (10 M\$/kW) and the high weight (200 kg/kW).

Thermophotovoltaic (TPV) Generator

Thermophotovoltaic energy generator is a system in which heat is first converted to radiant energy. After, it is converted to electrical energy by a photovoltaic cell (PV). The Figure 7.14 shows such a concept.

Selective emitters based on the rare Earth oxides-solid are the most promising. Contrary to most solids that emit in a continuous band, the rare Earth materials emit in narrow bands which can be matched with the absorption band of the solar cell. The following materials promise the largest efficiency at a moderate temperature (1500 K). These are the oxides from neodymium (Nd_2O_3), holmium (Ho_2O_3), erbium (Er_2O_3), ytterbium (Yb_2O_3).

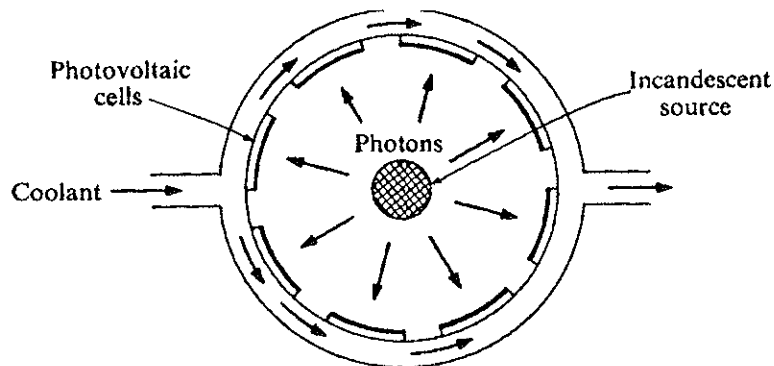

Figure 7.14 Coaxial geometric TPV converter [Angrist, 1982]

The radiative collection efficiency, for an emissivity ratio of 0.1 or less, can be as high as 80%. In addition the solar cell efficiency of spectrally tuned cell is presented in the following graph. We can observe that the efficiency drops considerably. Then, for the operating temperature of 1500 K, the cell and emitter combination can only provide an efficiency of 30%. Nonetheless, the total conversion efficiency from radiative power to electrical power is greater than 20%. If we consider a 50% loss for the emitter conversion of heat to radiation we obtain 12% for the total system efficiency. With higher operating temperature such as 1800 K, this overall efficiency can be substantially increased up to 16%. Additional information about the selective emitter thermal-to-electric conversion efficiency could be found in [Chubb, 1992].

Two main types of TPV systems exist. One uses a selective emitter material to radiate in the energy band where the PV cells are the most efficient. The other alternative is to heat a black body which serves as a thermal emitter. In this case it is preferable to use a filter to allow only the bandgap energy of a specific PV cell and reflect all other photons back to the emitter. This filter protects the solar cell from additional heat to prevent degradation of the PV material. In addition, suitable geometry such as a coaxial system can minimize reflection losses by directing the energy that is not absorbed on initial impact to another converter surface. However, TPV systems require cooling for the PV cells. This subsystem handicaps the TPV concept because of the additional weight needed. In this regard, TPV, thermoelectric and thermodynamic conversion systems are very similar.

New Concept of Thermal Engine Called "Gyroreactors"

The principle behind this technology can be compared to the air flow in the atmosphere. On the ground the air gas is heated and then rises in the higher atmosphere where it is cooled. The same phenomenon is applied here. A rotating engine generates a gravity field that attracts cold gas on the outside. This gas is heated by passing through copper fine plates. Energy is collected on the receiving area and convected to these plates. The hot gas is then moving against the gravity field and through a fixed turbine which enables this engine to rotate. At the exit of the turbine a water radiator cools the gas. The rotating components such as the radiator and the heat exchanger need advanced industrial production methods which cause high manufacturing cost.

This concept provides a few advantages very useful for space power systems. Less surface is needed for concentrators and radiators than the usual cycle engine. The power flux needed is 40 W/cm² which is easily provided by the actual concentrators. However, the main advantage is the high efficiency achievable with this system. 45% efficiency is predicted for its thermodynamic cycle that operates over a temperature range from 850 K to 330 K. This efficiency is three times higher than what is usually measured at these temperatures for the classical gas turbines. These numbers correspond to an electric power of 400 W/kg based on the engine mass. These achievements have considerable impact on the modern space application.

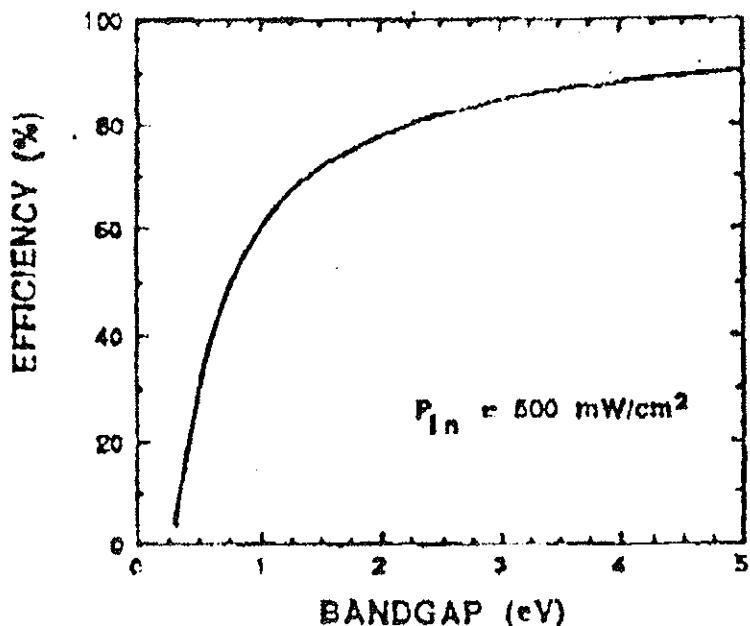

Figure 7.15 Calculated Efficiency for Monochromatic Cells Coupled to Laser Light Tuned to the Cell Material Bandgap, and Assuming an Input Power of 500 MW/cm². [Chubb,92]

The gyroreactor proposed prototype presented in is shown on Figure 7.16. [Bailly du Bois, 1991] This engine uses xenon with 0.3 % of helium as a working fluid. It can produce 20 kW if a radiation flux of 40 W/cm² is considered. With a higher radiation flux (136 W/cm²) the same reactor can generate 50 kW. In each case the rotation speeds are different (20 000 RPM and 50 000 RPM). The following parameters give additional information about the engine.

- * Radiated surface : 1075 cm²
- * Rotor's weight : 50 kg
- * Distance between the lateral faces of the rotor : 160 mm
- * Maximum distance from the axes (outer shell) : 195 mm
- * Pressure operation : 5 to 50 bars
- * Maximum temperature : 800 K

Liquid Droplet Radiator

Radiators are a dominant percentage of the mass of large solar dynamic power systems. The current technology which is the heat pipe radiator has a specific mass of 5 kg/m². To reduce the mass, a few concepts such as moving belt, dust radiators and liquid droplet radiator (LDR) have been proposed. One of the most promising is the LDR which can be up to 10 times lighter. This concept is shown schematically in Figure 7.17. This radiator has two main components; the droplet generator and the collector. The heat is radiated in space through the surface of billions of droplet traveling in between those two parts. Droplets' diameter size range from 60 to 1000 μm.

For the design, the main parameters are the droplet diameter, velocity, the type of the working fluid and the distance between the droplet. The mass of the system was found to be quit sensitive to the fluid density, fluid specific heat and emissivity. In addition, LDRs have a lower rejection

temperature which implies a different power cycle optimization such that less recuperation is needed for the thermodynamic cycles. This will have a lowering effect on the overall mass and thus proper comparison with other systems must consider that type of indirect benefits. Figure 7.18 and 7.19 present a comparison between LDR with different working fluids and heat pipe radiator. These results could be even more impressive if improvements on the LDR technologies are made such as the use of liquid metal droplets.

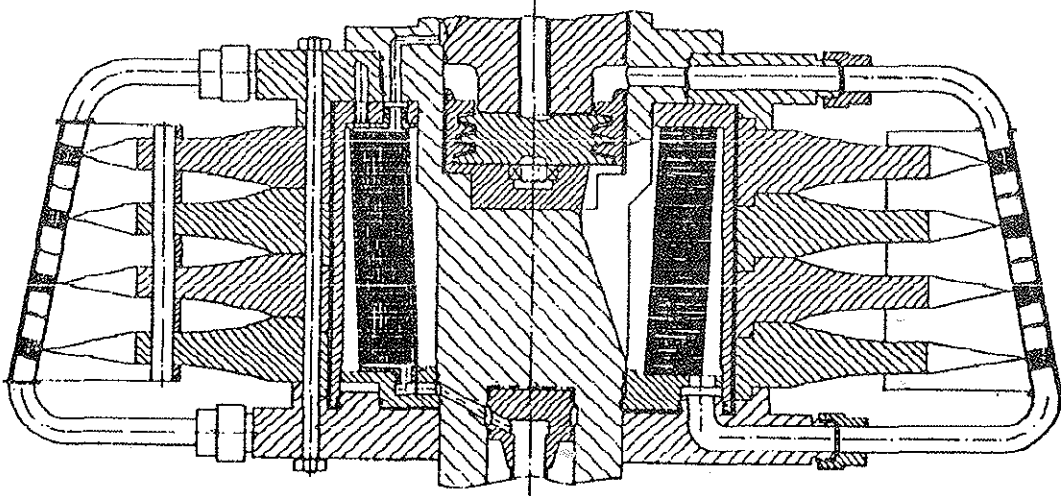

Figure 7.16 Schematic view of a Gyroreactor [Bailly du Bois, 1991]

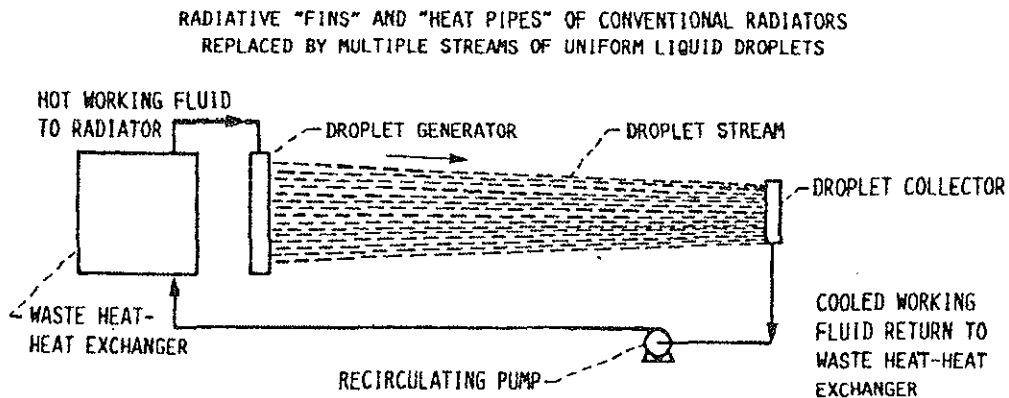

Figure 7.17 Liquid Droplet Radiator Concept [White, 1987]

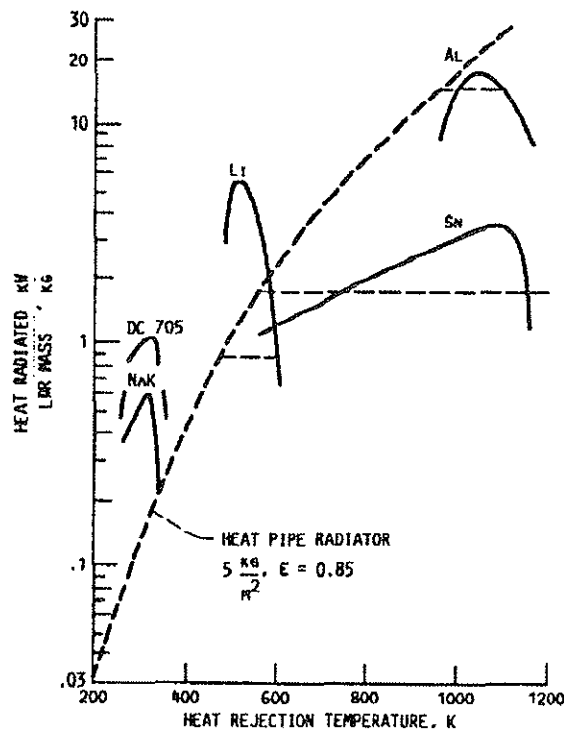

Figure 7.18 Comparison of Specific Power for LDR and Heat Pipe Radiator [White, 1987]

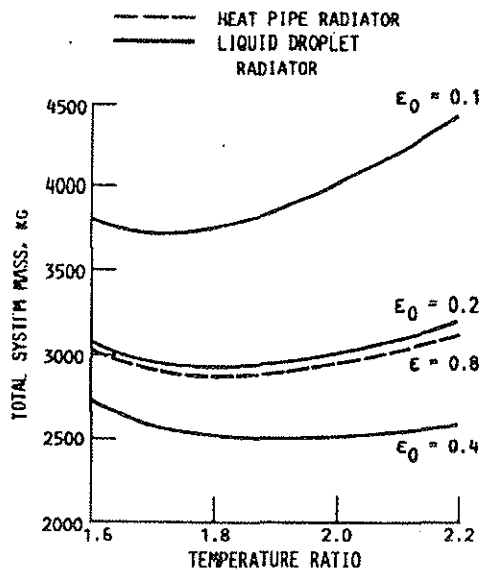

Figure 7.19 Mass Comparison for LDR and Heat Pipe Radiator for 100 kW Nuclear Stirling Power System [White, 1987]

LDR also promises a more compact storage and easier deployed in space when compared to the existing technology. LDRs are highly resistant to damage from micro meteorites and space debris since that only the droplet generator and the collector can be damaged. On the other hand special consideration has to be taken to avoid potential contamination of the spacecraft due to the backscattering of the working fluid evaporation. Droplets which impact the spacecraft surface at high velocity can release additional contaminants.

The LDR technology is presently under development. Up to now no unresolvable technical issues have been identified. Lately, the droplet generator at startup and shutdown has been investigated. Additional work is needed on the collector. Demonstration of a prototype could be planned on the Space Station. This promising technology could be considered in many mid-term applications. It could bring new hope to the solar dynamic systems.

7.2 Power Transmission

Wireless power transmission can be presently performed through two possible technologies, microwave and laser. They are presented in this section discussing the generation of the transmission beam, beam propagation, reception and conversion to electricity.

7.2.1 Microwave Transmission

In this section the general principles of microwave power beaming and reception are discussed. Different types of antennas suitable for microwave power transmission are examined. Special attention is paid to phased array antenna technology. The atmospheric effects on the transmitted beam are addressed. An overview on the microwave sources technology for power transmission is presented. The last part of this section concerns rectenna technology and siting.

Microwave Antennas

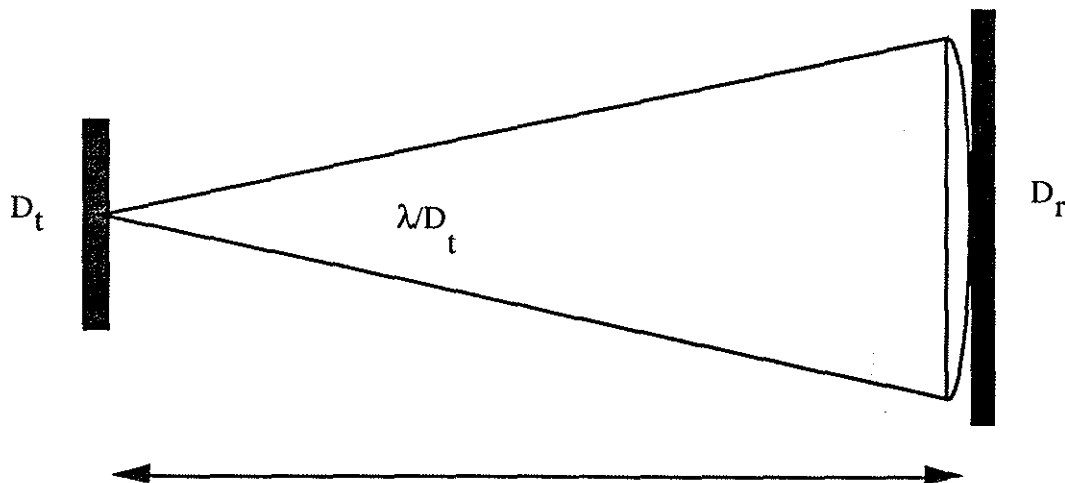

Figure 7.20 Mainlobe Radiation Pattern

The basic radiation characteristics of any antenna is determined by its dimensions and the transmitting wavelength. If the transmitter is emitting an equal amplitude and phase wave front, the far-field radiation intensity will be a simple diffraction pattern. Approximately 90% of the transmitted energy will be within the mainlobe of the antenna, as shown in Figure 7.20 while the rest is spread out into the grating sidelobes. The angle defined by the mainlobe is roughly λ/D_t (radians), where D_t is the diameter or width of the antenna. In the case of a perfectly circular aperture the beam width is given by $2.44\lambda/D_t$. For an antenna located at a distance H , the transmitting antenna will produce a footprint with a diameter D_r .

$$D_r = 2.44H\lambda / D_t$$

The above equation illustrates the fundamental relationship between transmitter antenna and rectenna sizes. For a given wavelength and transmission distance, the product $D_t D_r$ is constant. In order to collect all the radiated power within the mainlobe of the antenna, the rectenna diameter must be equal or larger than the footprint diameter. If the receiver antenna is smaller than the footprint the efficiency of the link decreases. This is illustrated in Figure 7.21 where receiving efficiency is plotted as a function of rectenna diameter.

Any antenna of finite size will introduce sidelobes in the radiating pattern. The energy can be focused into the mainlobe by introducing a tapering of the illumination pattern towards the edges of the transmitting antenna. The tapering is usually expressed in decibel notation where a 10 dB taper indicates a factor of 10 reduction in intensity from center to edge. This causes a widening of the mainlobe and decreased sidelobes. The amount of tapering used for the antenna is essentially a tradeoff between footprint-size and antenna efficiency. For power beaming applications a Gaussian distribution with a 10 dB taper is found to be the most efficient. [Woodcock, 1980]

The power density distribution on the ground is directly related to the radiation pattern of the array. Assuming that the maximum radiation level occurs at boresight from the transmitting antenna, the power density function S_r can be expressed as

$$S_r = \frac{P_t G_t}{4\pi H^2} \quad [\text{W/m}^2]$$

where

P_t is the Power delivered to the antenna and

H is the Distance from antenna to rectenna

G_t is the Transmitting antenna gain, which can be expressed as

$$G_t = \eta A \frac{4\pi}{\lambda^2}$$

where

A - physical area of aperture.

η - radiation efficiency of the transmitting antenna.

Care should be taken when employing this formula. G_t is generally a function of the radiation angle and the formula only applies to the far-field of the antenna. S_r is in this case the maximum electromagnetic flux density incident on the receiver antenna

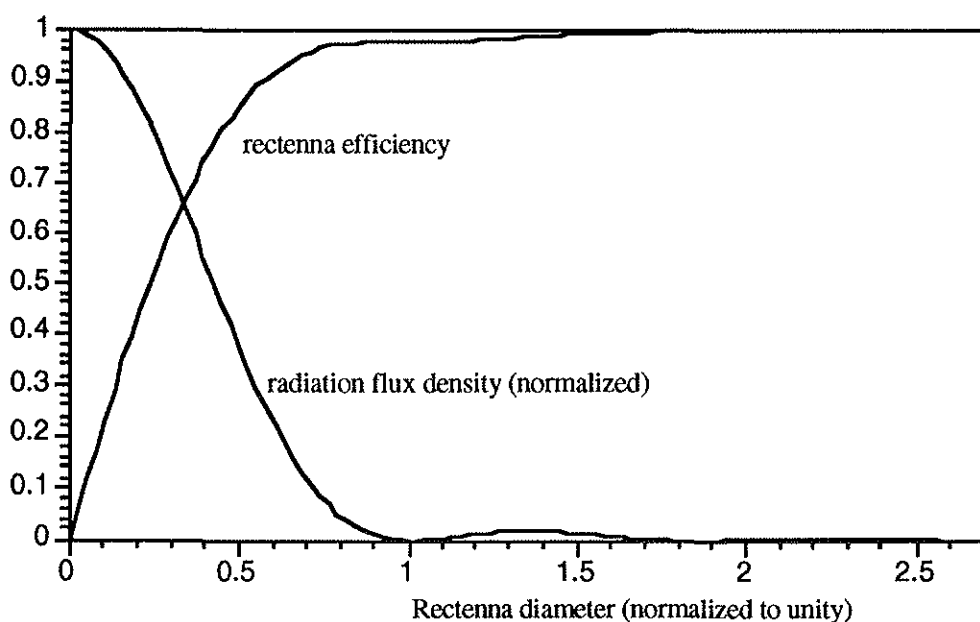

Figure 7.21 Rectenna Efficiency

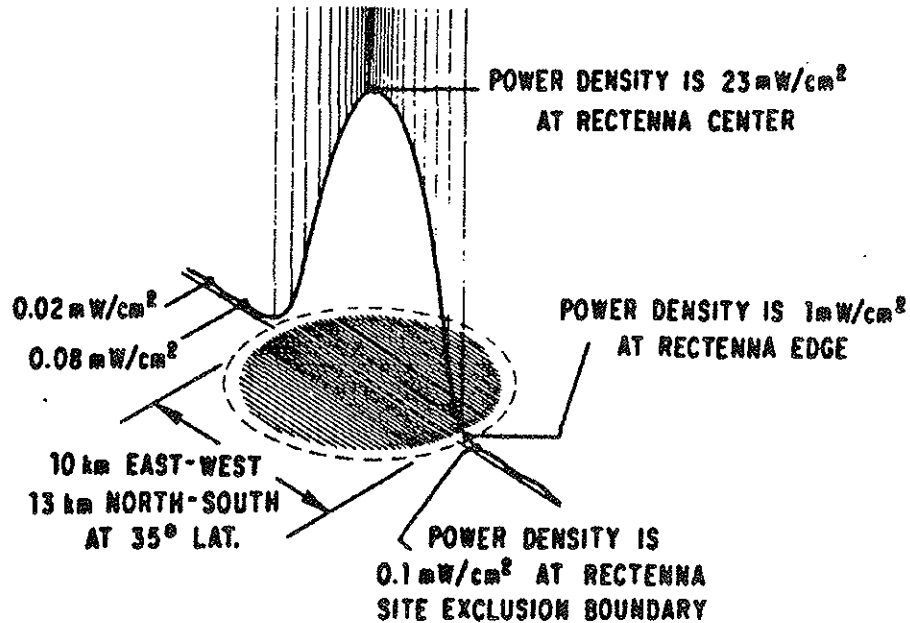

Figure 7.22 Power Distribution at Rectenna

The most obvious candidates for power beaming antennas are large reflector antennas or array antennas. A reflector antenna uses one or several feeder elements to illuminate a reflector surface. The feeder is positioned so that the output of the reflector represents an equal-phase wave front in the direction of the receiver. Reflector antennas are efficient and widely used. However, they require mechanical steering in order to direct the beam in a given direction. For large antennas in space this represents a serious limitation in their usage. For precise beam control applications, large arrays of discrete elements are found to be more feasible. An array antenna consists of individual radiating elements equally distributed over the radiation surface. The spacing between each element is approximately half the wavelength in order to avoid grating sidelobes. By controlling the phase of each element the mainlobe direction can be steered without physically changing the orientation of the antenna.

If the transmitting antenna is mounted on a spacecraft which moves with respect to the rectenna, some sort of beam pointing must be used. For low accuracy pointing (e.g. $<1.0^\circ$) mechanical steering of the antenna can be utilized. For power transmission much higher pointing accuracy is required. In general we require pointing accuracy to be significantly lower than the beam width of the mainlobe (λ/D_1 rad). As an example, a 100 m antenna transmitting at 2.45 GHz will require pointing accuracy better than 0.05° . Pointing accuracy requirements increase with frequency and antenna size. It is therefore desirable to use electronic steering of the beam. Large phased array antennas already exist for C-band. The Radarsat SAR antenna operates with a pointing accuracy within 0.2° . [Raney, 1991] It is expected that the same technology will be available for phased arrays operating at higher frequencies in the near future (e.g. 35 GHz).

Several different types of antenna radiators can be used in an array configuration. The elements must, however exhibit a certain omnidirectionality in order to steer the phased beam within a reasonable angle around the antenna boresight. Regular dipoles mounted on a ground plane have been used as well as slotted waveguides or waveguide horn antennas. Waveguides have high power handling capability and they can easily be connected to klystron converters with low insertion losses. Figure 7.23 shows the configuration of a slotted waveguide radiator.

Most modern phased array antennas utilize microstrip patch antennas where each element is fed from solid state hybrid power amplifiers or microwave integrated circuits (MIC's). This scheme eliminates the need for distribution of RF power within the antenna structure. Solid state devices operate at a temperature lower than 130°C thus limiting the permissible power density on the antenna surface. At present solid state amplifiers operate with an efficiency below 50% and efficiency decreases with increased operating frequency.

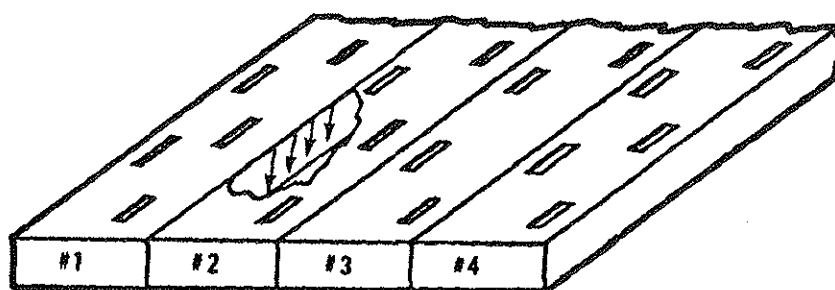

Figure 7.23 Slotted Waveguide Radiator [Schroeder, 1980]

More recent developments in the area of microwave monolithic integrated circuits indicates that they might be used for high power applications. They offer a number of advantages over solid state hybrid circuits including small size, light weight, high reproducibility and low cost. At present MMIC GaAs FET (field effect transistor) amplifiers exhibit an efficiency of only 10-15%. Figure 7.24 shows a solid state antenna design where the antenna elements are integrated with the solar cells.

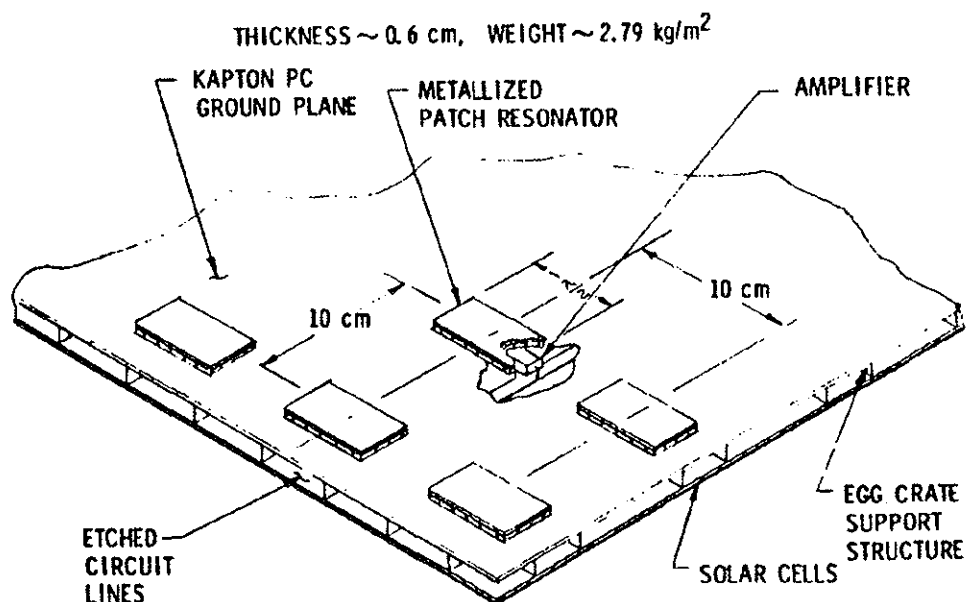

Figure 7.24 Integrated Solar Cell and Solid State Amplifiers. [Rockwell, 1980]

Phasing of the individual elements can be achieved in a number of different ways. For large antennas small perturbations of the antenna surface will affect the beam pointing. Therefore, continuous phase monitoring of the antenna elements is required. For long distance power transmission various retrodirective control schemes have been proposed. A retrodirective system uses a pilot beam transmitted from the rectenna. Each antenna element receives the pilot signal which is used to generate the appropriate phasing. The power beaming system for the METS experiment is an example of a two tone pilot signal system. [Kaya, 1991a] The pilot signals are slightly shifted in frequency with respect to the power carrier signal. The correct phase for each radiating element is fed to digital phase shifters producing the correct element phase. A block diagram of the METS phase control system is shown in Figure 7.25.

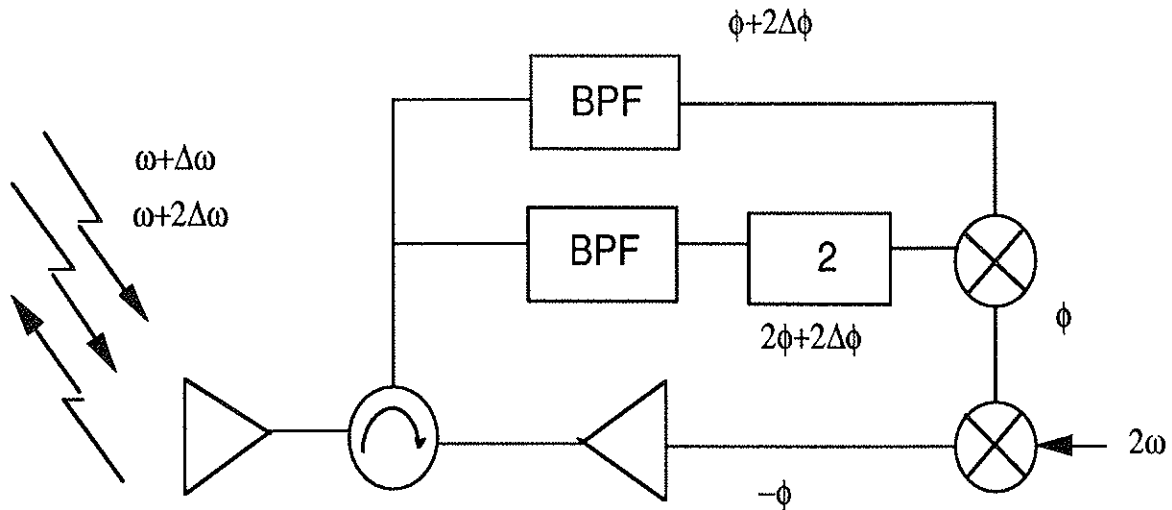

Figure 7.25 Two Tone Pilot-Signal Retrodirective Antenna [Kaya, 1991b]

Atmospheric Effects

Power transmission by means of microwave technology is presently used for many ground applications and it is considered suitable for space power beaming.

The electromagnetic radiation can be used for information transmission as well as for power transportation to or from space. Three different applications can be considered in this area: microwave transmission from earth-to-space, from space-to-space, from space-to-earth. Each one of these problems requires a different approach and choice of the optimal criterion for the parameters to be set.

One of the most important parameters to be selected is the frequency of the electromagnetic radiation used for the power transmission. The choice of the frequency depends on many factors, such as the beam interaction with the atmosphere, the size and the mass of the instruments, the environmental and safety issue, the efficiency achievable and the technology availability and reliability. [Rybakov et al.,1991]

The frequency employed since the early utilization of microwave transmission is 2.45 GHz. The reason was mainly the poor influence of the earth's atmosphere on the processes of electromagnetic propagation in S-band shown in Figure 7.26. The ionosphere of the earth is usually opaque to frequencies below 10 MHz and has strong effect on signals with frequencies up to 1 GHz. The frequency 2.45 GHz is still considered one of the most attractive also because of the good technical support available for both power generation and focusing of the radiation.

At 2.45 GHz the diameter of an orbiting transmitting antenna is 1 km and the one of the ground receiving antenna is 10 km. Using higher frequencies the antenna and rectenna size can be considerably reduced (the antenna size is 10 times smaller at 35 GHz) and therefore also the costs decrease. But the efficiency of the power transmission, the lack of technology available and the effects of the beam interaction with the atmosphere at higher frequencies make the problem of the optimum criteria for the frequency selection particularly critical.

The interaction of microwave radiation with the earth's atmosphere is a very complex problem to be analyzed. When a microwave beam propagates through the earth's ionosphere many phenomena occur. The most important are summarized in the following.

- The electromagnetic radiation is influenced by absorption of the oxygen molecules and water vapor. At higher frequencies, molecular absorption in the earth's atmosphere produces remarkable losses as the waves propagate through the atmosphere. Figure 7.27 shows the atmospheric attenuation over the spectral region up to 300.
- Rain, mist and cloudiness produce an attenuation of the radiation.
- The presence of the earth's magnetic field leads to Faraday rotation of the electric vector affecting any polarization measurement.

- The ionosphere's inhomogeneities and turbulence has as a consequence a random changes in the amplitude and phase of the propagating wave.

Referring to the frequency, the absorption due to the atmosphere in the range of 2.45-3 GHz is 0.05 dB, but this value increases sharply up to frequencies around 30 GHz. However, there is a "radiowindow" in the range 35-38 GHz (millimeter waves) in which the absorption decreases up to 0.4 dB. The other phenomenon to be considered is the electromagnetic dispersion due to the presence of rain, cloudiness etc...

At 2.5-3 GHz the loss of energy due to the precipitation are estimated around 2-6%. At 35-38 GHz those losses are 8-11%. In this range a very strong loss (up to 12 dB) occurs in presence of dense cumulus-rain clouds and heavy rain. The total atmospheric attenuation of a 35 GHz beam in traversing vertically through the atmosphere in clear weather is 0.2 dB.

Therefore the range 35-38 GHz can be used but only if the receiving ground antenna is placed in the earth's regions with small quantity of rain and cloudiness. But the factor which hamper the practical use of the millimetric waves is in the limited availability of powerful and efficient microwave sources in this range [Koert et al,1991]. For instance, obtaining hundreds of kilowatts of power with a single source at millimeter wavelengths was impossible before the introduction of a particular class of microwave vacuum tubes: gyrotrons. They are capable of generating 200 kilowatts CW at 35 GHz. An other technical problem is connected with the necessity of phased arrays which are not available so far at 35-38 GHz.

The choice of the site of the rectenna is very critical, since the weather condition can strongly effect the system performances. Usually, the rectennas are located in remote places. A site can be on the equator in a very dry area. The idea of placing a rectenna in Antarctica presents some problems at 35 GHz: while a surface covered by snow is completely transparent in S-band, it is not at all visible at frequencies above 10 GHz as shown in Figure 7.28.

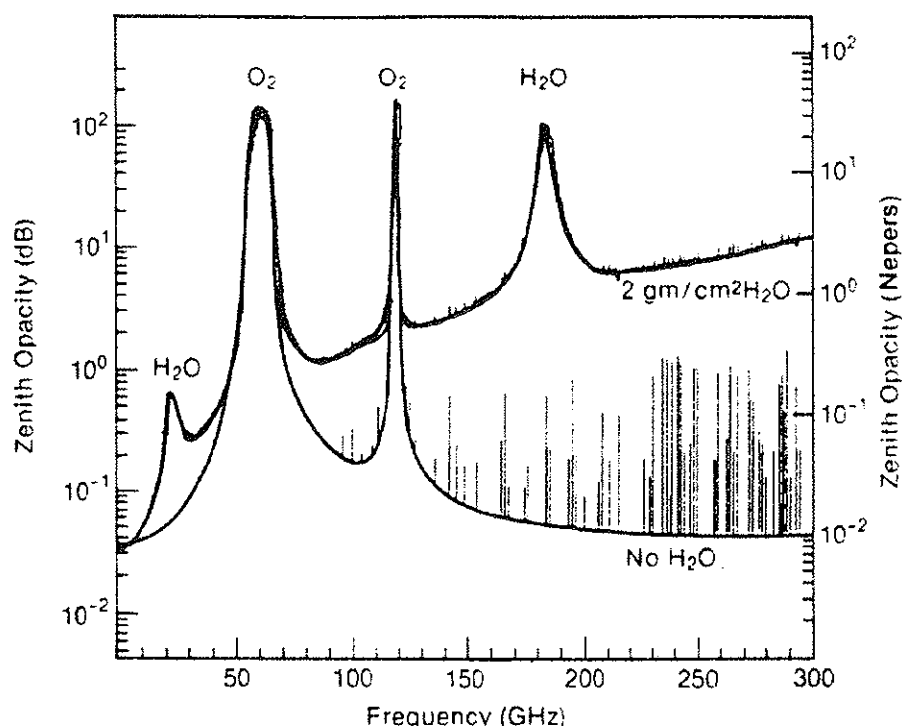

Figure 7.26 Atmospheric Attenuation Across the Radio Microwave and Millimeter Regions of the Electromagnetic Spectrum [Elachi, 1987]

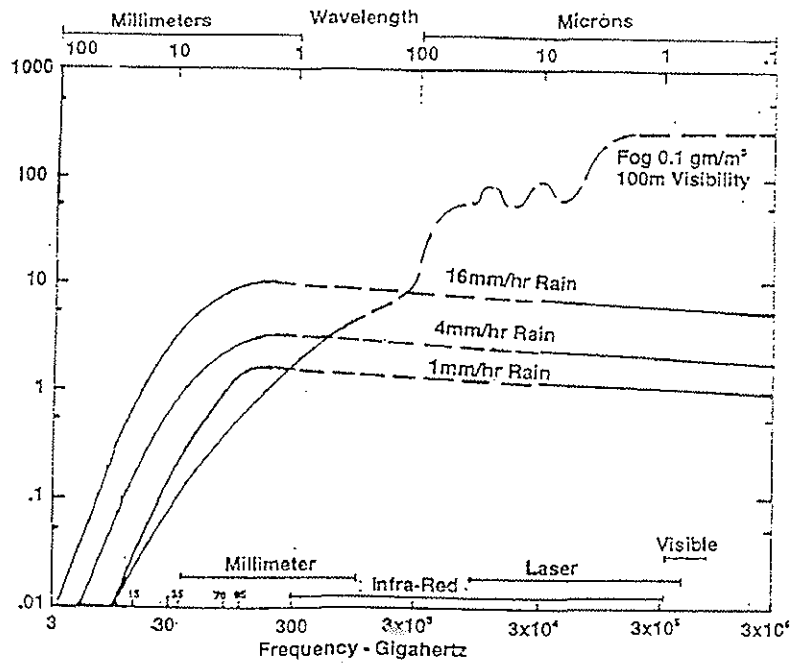

Figure 7.27 Atmospheric Attenuation Due to the Rain and Fog

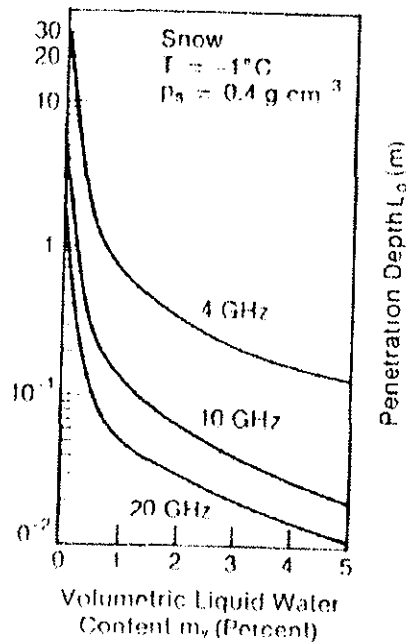

Figure 7.28 Penetration Depth as a Function of the Frequency for Snow [Ulaby et al. 1982]

Microwave Power Transmission

The electrical power transmission by means of electromagnetic wave beams was introduced by P.E. Glaser in 1968. The first experiment of beaming electrical power over several kilometers by microwave dates back to 1975. [Brown, 1984a]

The idea was to use large orbiting stations to collect solar energy on geostationary orbit, to transform it into electricity and then into microwaves. Once the microwave energy is transmitted to the earth's surface, it can be reconverted into electricity and distributed in the conventional power networks.

Microwave Tubes

The microwave power production is currently performed by using tube technology. [Brown, 1981] Within a certain range of power and frequencies this technology is well confirmed and mature. At low frequencies (S-band) a power output of several MW can be obtained. But the power level decreases using higher frequencies. To transmit a given amount of power at a given frequency, two possible solutions can be adopted: single source or combined sources. The choice is made considering the most cost effective one.

The single source solution requires a high power tube. The transmitting antenna can be a standard one, with feed horn and attitude control using thrusters. The second solution employs several low power tubes and this leads to different ways to combine those tubes. Usually in telecommunications and direct broadcasting satellites the output signals from the tube may be added in-situ through hybrids, with proper phasing, to feed a standard antenna. An other technic is used for radars and requires that each tube amplifier feeds one horn of a phased array antenna, which achieves a spatial summation of the signals at the desired location.

All microwave tubes are based on the same principle of transferring part of the kinetic or potential energy of the free electrons in a vacuum to an RF field carried by a microwave structure. The primary energy of the electrons is supplied by high accelerating voltages generated by a power supply.

Linear Beam Tubes: Klystrons

Multicavity klystron amplifiers are longitudinal interaction tubes. They have four or five resonant cavities, separated from each other by narrow drift tubes. The input cavity is connected to the signal to be amplified and the output cavity to the useful load. The bandwidth is usually very small. At higher frequencies (10-30 GHz) the klystron can produce up to 100 kW and it is suitable to be used in small size satellite power stations.

Crossed-field Tubes: Magnetrons

A magnetron is a circular diode to which a magnetic field parallel to its axis is applied. Oscillations occur when the electrons are given specified values of angular velocity. It is a low cost, high efficiency (80%) tube. But its high power capability is limited to a small frequency range. For instance at 10 GHz, the power capability is few hundreds watts.

Fast-wave Tubes: Gyrotrons

Gyrotrons are new millimeter-wave vacuum tubes. They are presently under development and promise to generate extremely high power levels.

Solid State Microwave Devices

The use of klystrons for conversion of energy from dc electrical power to microwave radio frequency energy leads serious concerns about the reliability of this devices. Solid state amplifier circuits, which use high efficiency, advanced technology (gallium arsenide transistors for dc/RF conversion) have been considered as a good alternative because of their high reliability. But in order to be competitive with klystrons, the solid state amplifier circuits and antenna combined efficiencies need to approach the same efficiency as the klystrons. For solid state devices two major problems have to be solved: the temperature of the amplifier base needs to be controlled to about 150 C for efficient and reliable operation and the working voltages must be low (about 40 volts).

Rectenna

The term "rectenna" is most often used to indicate the whole receiving part of a microwave power transmission system. From this point of view, the rectenna refers to the structure that intercepts the main lobe of the transmitting beam, in order to collect the major part of its power. This structure is an array of elements, where each of those is converting the locally incident RF power. The term "rectenna" originally referred to each of these elements. It stands for "rectifying antenna" (and

not "receiving antenna") as the RF to DC conversion is conducted by rectifying the wave. We will then use "rectenna" when we consider a single element, and we will use "rectenna receiving array" when we consider the whole structure.

Since the early beginning of these technology developments, severe requirements have been placed upon the collector-converter unit [Brown, 1977]:

- large aperture and non directive,
- minimal radio frequency interference,
- high power handling capability,
- high efficiency,
- ability to passively radiate any heat resulting from inefficient operation,

and of course:

- high reliability, very long life, low cost, light weight, ...

As the rectenna concept has directly shown its ability to cope with almost all of these demands, the history of microwave collector-converter technology is mainly that of the development of the rectenna. Nevertheless, the radio frequency interference (RFI) requirement is probably the main problem for some rectenna designs. RFI, however in the form of harmonic power, is a special problem that confronts both the transmitter and the receiver. The harmonic level must be down to a very low level to meet non-interference requirements. This can be met by wave filters, but results in higher cost and reduced efficiency since these requirements are severe. A proper solution could be to have an allocation of frequencies for the harmonics that are generated in the system [Brown, 1977].

The way the rectenna converts the RF signal to DC power is illustrated by Figure 7.29. An example of an early implementation is shown in Figure 7.30. Recent rectennas no longer look like this one as many technological improvements arose, but this picture gives the reader a concrete idea of the various components of the rectenna. The RF energy is collected by an antenna, rectified by a diode, and low-pass filtered in order to extract the DC component. A microwave low-pass filter can be found between the antenna and the diode, to attenuate the harmonic radiation, and to store energy for the rectification process.

The rectenna global efficiency is given by the product of the power collection efficiency and the rectification or conversion efficiency. The collection efficiency characterizes the ability of the rectenna receiving array to capture the incident microwave power. This is measured by means of VSWR (Voltage Standing Wave Ratio) measurements of a probe in front of the array. (This gives access to the ratio of what is collected, and what is reflected away by the structure.) A high collection efficiency is then achieved by matching the surface impedance of the rectenna array to the impedance of the propagation media (the air or the vacuum). A proper design allows to reach collection efficiencies as high as 99% so that this factor is not limiting.

The losses at various points of the conversion circuit make the conversion efficiency more critical. The filters losses are only few percent of the whole figure, so that it is difficult to try to reduce them. On the contrary, diode losses could vary between few percent up to few tens of percent. Because the diode rectifier is such a critical element, a search for diodes that would improve the efficiency and power handling capability of the rectenna has been a continuing process. These losses follow a curve that depends on the voltage drop in the forward direction of the diode. This voltage drop must be reduced as much as possible, in order to maximize the conversion efficiency. The gallium arsenide Schottky-barrier diodes have shown good performance for that purpose.

The existence of this voltage drop across the diode has a very important consequence on the operating performances of the rectenna: the efficiency is directly related to the incident power following a non-linear function. A kind of threshold exists for the incident power, below which the rectification efficiency drops very quickly, from about 85% down to nothing. Usually, this problem is not frequently mentioned, as people look forward to high power transmission systems. Obviously, this assumption does not hold for the early low power demonstrations. Care must therefore be taken when designing these first systems

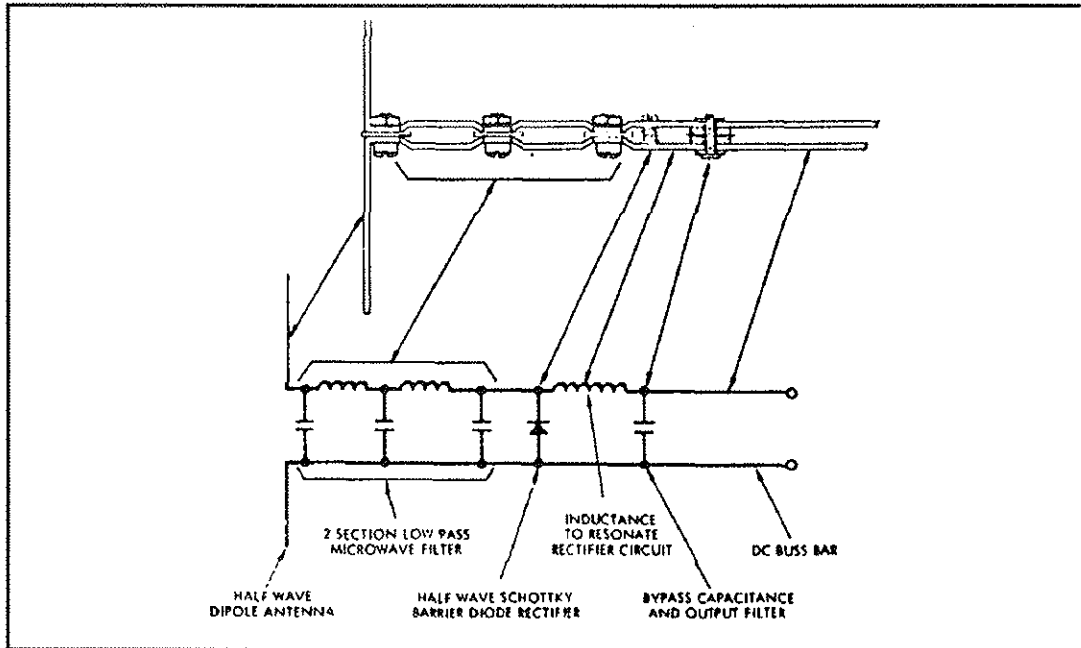

Figure 7.29 Simplified electrical schematic for an early rectenna element [Brown, 1977]

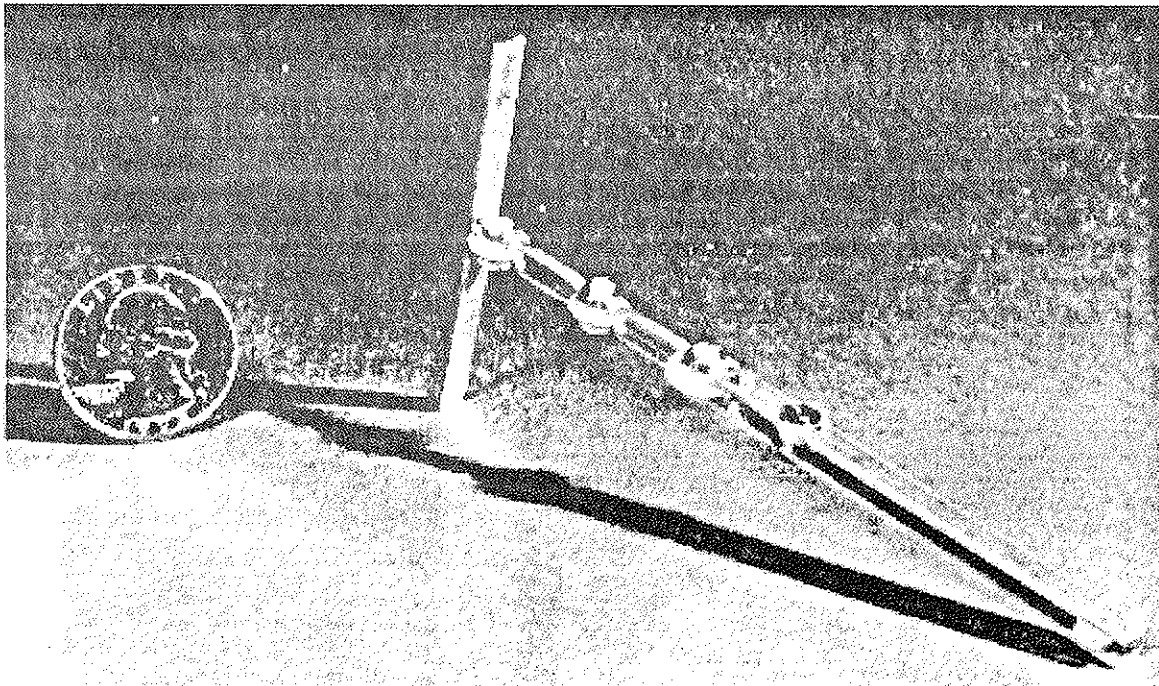

Figure 7.30 Photograph of an early rectenna element [Brown, 1977]

Minimum Power Density Estimation

Further investigations should be undertaken to provide a relevant minimum value for the power density. Nevertheless, the order of magnitude can be estimated in the following way.

Let us assume that each diode is driven by the signal collected by a half-wave dipole. V_0 is the voltage drop across the diode, which is the minimum voltage to turn it on. The power collected by the dipole is transmitted to the diode as a voltage wave through the characteristic impedance R of the dipole. So, in order to turn on the diode, the minimum power to be collected is given by

$$P = \frac{V_0^2}{R} \quad [W]$$

The effective area of the dipole is given by

$$A_{\text{eff}} = \frac{\lambda^2}{4\pi} G \quad [m^2]$$

where G is the gain of the dipole, so that the needed power density S is

$$S = \frac{P}{A_{\text{eff}}} = \frac{V_0^2 4\pi}{R\lambda^2 G} \quad \left[\frac{W}{m^2} \right]$$

Let us consider a numerical example. The voltage drop V_0 is usually about 0.4 V. The gain of a half-wave dipole is about 1.5, and its impedance is a few tens of Ω . Let us take 50 Ω as a reference impedance. If we consider a frequency of 2.45 GHz, the minimum power density required is

$$S = \frac{(0.4)^2 4\pi}{50 \cdot (0.12)^2 1.5} = 1.8 \quad \frac{W}{m^2}$$

If we consider a frequency of 35 GHz, we find

$$S = \frac{(0.4)^2 4\pi}{50 \cdot (8.57 \cdot 10^{-3})^2 1.5} = 365 \quad \frac{W}{m^2}$$

These low limits are very rough estimates of the power that only allow the diode to turn on without delivering any power to the system. The actual power densities should then be about one order of magnitude higher to get any DC power. Nevertheless, the reader should keep in mind that these figures assume that each antenna feeds its own diode. Several antennae could be combined to feed a common diode to increase the collection surface per diode.

Another limitation exists because the parasitic capacitance of the diode degrades the conversion efficiency. This can be estimated from an energy point of view. To drive the diode, each half cycle of incoming wave must deliver enough energy to the dipole to activate the diode. The energy delivered is the product of the power density by the effective area and by the half cycle time. Thus:

$$\frac{S\lambda^2 G}{2f \cdot 4\pi} \geq E_0$$

where E_0 is the diode activation energy. This is proportional to the capacitance C_d of the diode:

$$E_0 = \frac{C_d V_0^2}{2}$$

Hence, we find

$$S \geq \frac{C_d V_0^2 f 4\pi}{\lambda^2 G}$$

and since $\lambda = c/f$, with c the speed of light, we can write

$$S \geq \frac{C_d V_0^2 f^3 4\pi}{c^2 G}$$

Again as an example, let us assume that $C_d = 1$ pF, $V_0 = 0.4$ V and the frequency $f = 2.45$ GHz, then we find that the power density must be higher than

$$S \geq 0.22 \frac{W}{m^2}$$

If we consider now a frequency of 35 GHz, this minimum power density increases up to 640 W/m². This problem of parasitic capacitance becomes then dominant and critical as the frequency increases.

Different Kinds of Rectennas

Different kinds of rectenna receiving arrays may be found, depending on the technology used for the rectenna elements. The early arrays were using the kind of rectenna illustrated by the Figure 7.30 [Brown, 1984a]. The manufacturing cost of such arrays is unaffordable for a large scale receiving area as foreseen for the future Solar Power Satellite systems.

Some simple rectenna structures have been developed, which consist of a single flexible layer in the form of an open mesh that could be installed simply by unrolling long sheets and interconnecting them appropriately [Collins, 1991]. The mesh would consist of 2 mm diameter plastic cable carrying RF-DC printed circuits and covered with a protective layer. Such an open mesh would pass rain and sunlight, but would have a very low efficiency (10%), as the energy collection would be very poor. A metallic reflector plane could be added behind the mesh to improve the collection efficiency. Obviously, this ruins the advantages mentioned before, and would increase the cost. The efficiency could probably be increased to perhaps 50%. This structure (with or without the reflector plane) is sometimes called a "magic carpet". Despite its relatively low performances, this remains an interesting solution for low cost, low power, quick and easy use rectenna sites.

For fixed and high efficiency (85%) sites, other ideas can be investigated. In order to increase the power density incident on the rectenna element, and to limit the surface of the actual rectenna receiving array, some concentrators can be used to focus the energy. This idea is extensively used with various rectenna technologies. [SPS, 1991] Nevertheless, the high efficiency provided by this simple idea is paid back through a significant increase of the cost. These reflectors can be realized with a plain metallic sheet or with a mesh or wires.

Another interesting kind of rectenna array has been investigated these last 10 years. A thin-film technology is used to provide a very light weight, low cost, reasonable efficiency (70%) and flexible rectenna array. The antennas, the rectifier diodes and the filters are all realized in a kind of microstrip technology that reduces tremendously the manufacturing cost and increases the reproducibility. These rectenna arrays are particularly well suited for uses in space, or wherever their qualities are vital. Again, an efficiency problem could arise if the considered power density is insufficient. An improvement could be found in grouping several antennas before the rectification of the signal, increasing the collection surface instead of increasing the power density itself. By doing that, another drawback arises as the directivity of the rectenna array increases. The trade-off must then be found depending on the application.

Finally, some other problems will have to be faced for the development of the large scale and high power SPS. The classical rectenna concept is limited in handling high power. Moreover, some reliability problems could be encountered as the number of elements increases. Some new technologies are investigated in order to solve these weaknesses, and are briefly introduced under the "new technologies" point.

New Microwave Technologies

Four mechanisms for space based power transmission include: tethers, microwave beams, submillimeter wave beams, and lasers. Tethers have a simple mechanism for transmitting power. However, due to physical limitations for transmitting space power, their use is restricted to platforms sharing the same orbit and within a tether distance. Currently, space based power transmission and reception technologies are primarily focused on microwave (about 10 cm wavelength), submillimeter waves (wavelengths less than 0.1 cm) and laser systems (micron wavelengths). This section will concentrate on microwave and submillimeter technology research. Space based laser systems will be discussed in the laser section (7.2.2). Microwaves are the most developed and widely used technology. Submillimeter waves, however, allow the use of much smaller transmitting and receiving antennae than microwave antennae. Technical developments are concentrated on improving these systems or changing the method of incorporating lasers and microwaves into the total solar power satellite system. This new technology summary of power

transmission therefore, will emphasize new microwave systems rather than identify new methods of transmission and reception.

The two examples discussed in this section integrate sub-system level components into one unit, such as a transmitter and solar cell into one power beaming unit. The advantages of integrating these systems for a space system application include: reductions in mass, size and thermal loss, as well as increases in power conversion and transmission efficiencies. These advantages are gained by the elimination of distribution wires and interconnects between electronic components, and the use of new and lighter materials for the solar cells, antennae, amplifiers, etc.

Integrated Microwave Antenna and Solar Cell

The development of new and more efficient solar power satellite designs is dependent upon new technologies of photovoltaic receivers (AlGaAs, InP, and CIS) along with improvements in RF and solid state electronics. One new concept has been proposed by Landis and Cull [Landis, 1991]. They propose to integrate the solar cell and microwave antenna into a monolithic building block as shown in Figure 7.31, that can be replicated and combined into a light collection area which is also used as the transmitting aperture. At this time, this design is only a concept which has not yet been implemented into hardware.

Two technical advantages are gained. The total satellite mass can be reduced by eliminating the need for a separate light collection area and transmitter which also eliminates some electronics and wire for power conditioning and distribution. This reduction in wire and electronic hardware also reduces the waste thermal management subsystem to small self-contained radiating surfaces. Secondly, because of the larger aperture that could be realized with the monolithic building block units, this integration could yield a narrower microwave beam at the receivers, hence smaller receivers can be implemented.

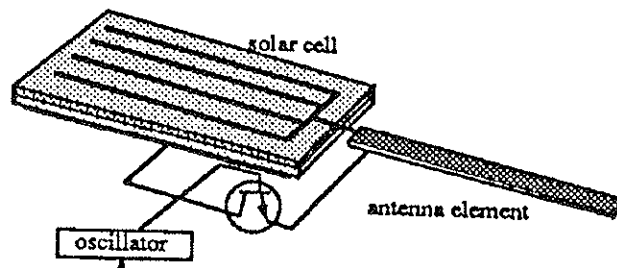

Figure 7.31 Solar Cell with Microwave Antenna, (conceptual design) [Landis, 1991]

Tubes are well developed and have been used as a DC to RF converter choice for most high power applications. However, receiving microwave power and converting it to DC power has been demonstrated with solid state electronic devices and microwave rectifying antennas (rectennas) using thin-film techniques on a thin plastic substrate. It is now reasonable to use solid-state electronics instead of tubes as the microwave source for solar power satellites. The use of an FET transmitter instead of a tube will be demonstrated in the next section. In conclusion, the integration of antenna with solar cell concept consists of three technologically feasible elements which have been previously analyzed, but require further development. Microwave antennae are directly integrated at the solar cell level. Secondly, both the photovoltaic and microwave devices are constructed with thin-film technology. And thirdly, the antenna can be steered by controlling each element's phase with the addition of computational electronics.

New FET Microwave Transmitter

In the near future, solid state transmitters could provide solar power satellites with long life, high reliability, low maintenance and high DC to RF conversion efficiencies at high frequencies. Solid state transmitters are continually being improved for efficiency and higher frequency operations by using new materials and manufacturing process techniques. A research group (Chief: Prof. H. Matsumoto) was organized to promote a METS (Microwave Energy Transmission in Space) experiment. [Kaya, Matsumoto, Akiba, 1991] In the METS experiment, the antenna was integrated with the amplifier in a three layer structure as shown in Figure 7.32. The new transmitter system will be used to radiate a monochromatic microwave of 2.45 GHz.

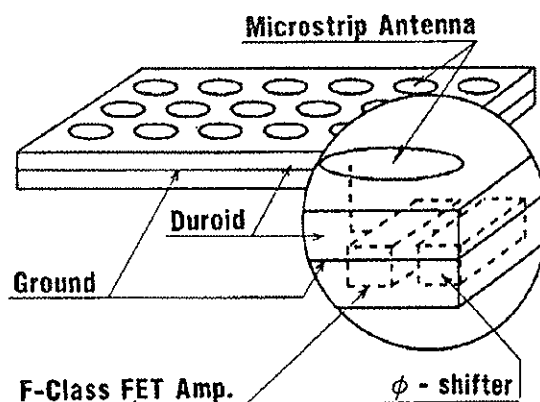

Figure 7.32 Antenna Paddle [Kaya, et al, 1991]

The power amplifiers are of the F-class type GaAs-FET (Field Effect Transistor) semiconductor, which is already more than 50% efficient. The FET is part of the antenna paddle, a sandwich structure of 3 layers which consists of the microstrip antenna, ground and FET amplifiers. The entire transmitting antenna consists of these four antenna paddles. Each antenna paddle is mounted with 18 microstrip antennas. The benefits of the microstrip antennas are their light weight, ease of fabrication and ease of implementation into mass production because they are flat.

This concept integrates the antenna component and FET amplifiers. Three economical and technical advantages that can be realized but not limited to with the use of FETs are discussed. Firstly, the FET power amplifiers can be directly connected to the DC input of the solar cells which supply the bias power for the FETs as is demonstrated in the METS project. This direct connection makes it possible to design a much simpler satellite structure. Secondly, although GaAs FETs are typically low power devices compared to klystrons and magnetrons and FETs are temperature limited to a few tens of watts each, the FETs are relatively inexpensive and can be used in large quantities. Lastly, solid state transmitters are continuously being improved by the demands of other electronic markets such as communications, power converters and integrated circuit technologies. Therefore, there are more economical gains and incentives for FET manufacturers to improve their FET devices with higher frequency capabilities and higher power efficiency operations. Better power efficiencies of the individual FETs can lead to less hardware for both power transmission and thermal management given a fixed power output for the satellite.

Solar power satellite technologies are heading toward the integration of sub-systems into one unit. Then, the units can be used as building blocks that are connected into many satellites of several different power output needs. Another interesting proposal may be to combine the two examples discussed in the previous two studies, an antenna integrated with an amplifier and an antenna integrated with solar cell. This can be accomplished by including the solar cell material on the fully developed antenna and FET amplifier that is already developed for the METS experiment.

Magnicons For Microwave Space Power Beaming

A new microwave source which could have potential as a highly efficient, high power, and high frequency source for space power beaming is a magnicon [Manheimer, Gold, Seo, 91]. In their paper study, Manheimer, et al, discuss a conceptual point design of a continuous wave magnicon at X-band, which has an efficiency of approximately 85%, a power of 200 kW and a gain of 18 dB. Other comparable microwave sources include: klystrons, magnetrons, and gyrotrons. Medium power klystrons and high power klystrons can be used in continuous wave mode. A medium power klystron, operating at frequencies between 1.3 and 18 GHz, can deliver up to 1 kW output power. High power klystrons (for example, "superklystrons") are capable of delivering 1 MW output power at 350 MHz with a 65% - 70% efficiency. Continuous wave magnetrons can deliver up to 6 kW of power at 2.45 GHz with efficiencies up to 70%.

The Soviets have developed a magnicon as a source to power accelerators at a frequency of about 1 GHz. Although, they have proposed designs at higher frequencies up to 7 GHz. The magnicon is an example of a "swept beam" device that operates more efficiently than a klystron or gyroklystron. With a magnicon, the electrons are phased to gain rather than lose energy.

7.2.2 Laser

Laser technology for power beaming is a good possibility. Benefits of laser beaming compared to microwave beaming are smaller receiving site, radiation outside the beam is negligible and side lobes do not interfere with other electromagnetic radiation. On the other hand, lasers have quite low system efficiency and higher losses on atmosphere. The efficiency is also dependent on the atmospheric situation. Higher power density on the beam can reduce the atmospheric attenuation by boring a hole through light clouds.

In this section we discuss about different methods to create a laser power beaming system. First subsection covers the conversion of electric or solar energy to a laser beam. The next subsection covers the propagation of a laser beam through atmosphere. This is followed with a subsection where we discuss about receiving of a laser beam. These subsections are a kind of introduction to laser power beaming. In the next subsection we present some applications using laser technology.

Conversion

A laser consists of a laser tube containing the lasing medium, or lasant, a system for pumping the lasant with energy and a system for removing waste heat. As a laser emits monochromatic, coherent light, a laser beam propagates for great distances with very little beam spreading. For power transmission purposes the laser has to be scalable to increase the output power.

The state of art in laser technology has concentrated on infrared lasers in the band of 2-11 μm . The state of art technology in photovoltaic cells requires much shorter wavelengths for power generation. Because of this some studies and experiments have been done in visual light wavelengths but these lasers are typically quite inefficient and not scalable. Main problems in scaling are gas purification and cooling. Gas purification is required to maintain the efficiency of the laser. Below we describe several laser technologies.

Electric Discharge Laser

Electric Discharge Laser (EDL) uses an electric field to maintain discharge and accelerate electrons to high speeds. This energy is transferred by collisions to lasant molecules. Collision transfers molecules to higher energy levels. Two primary EDL types are CO_2 and CO. The CO_2 EDL operates at lasant temperature of 300-600 K and its primary output line is 10.6 μm with efficiencies of 10-23%. A number of CO_2 EDLs can have their output beams 'phase-locked' so the collective beam is coherent and monochromatic. The CO EDL operates at a lasant temperature <100 K. Its output beam consists of lines at 4.8-5.3 μm with efficiency of 23-30%. This laser type can not be 'phase-locked' since it has many separate lines in the band.

This laser type is widely tested and its operation is well understood. Because of a 'phase-locking' capability of a CO_2 laser it is quite good alternative for power beaming purposes. This laser type has however low reliability and its lasant has easily a breakdown. [Walbridge, 1980]

Solar Pumped Lasers

Solar energy pumped laser is a good choice for space laser power system. Due to direct use of solar energy, no conversion from solar to electric energy is needed for beamed power. The system itself requires some electricity for controlling purposes. The temperature of the lasant has to be kept at an operating level. The cooling of the lasant requires an efficient cooling system that can be achieved with an active system. An active cooling system needs much energy, that can be either electric or mechanical. In both cases some secondary power converter is needed.

Direct solar pumped lasers can use only few narrow bands of total solar energy as shown in Figure 7.33. To avoid excess heating of laser system, unused bands of solar energy have to be filtered or reflected out to reduce the heating on the lasant. The amount of useful solar energy in the total spectrum is at most 2.5%. If the efficiency of the laser is 20%, the overall efficiency from solar energy to laser beam would be 0.5%. This means that pumping energy has to be concentrated over a large area. Using solar energy value of 1.3 kW/m^2 the minimum required collection area A_r for output power P_o is the following:

$$A_{r_{\min}} = P_o / 6.5 \text{ m}^2$$

For a 100 kW laser beam this means a mirror at least 140 m in diameter. [Beverly, 1980c][Taussig, 1979][Walbridge, 1980]

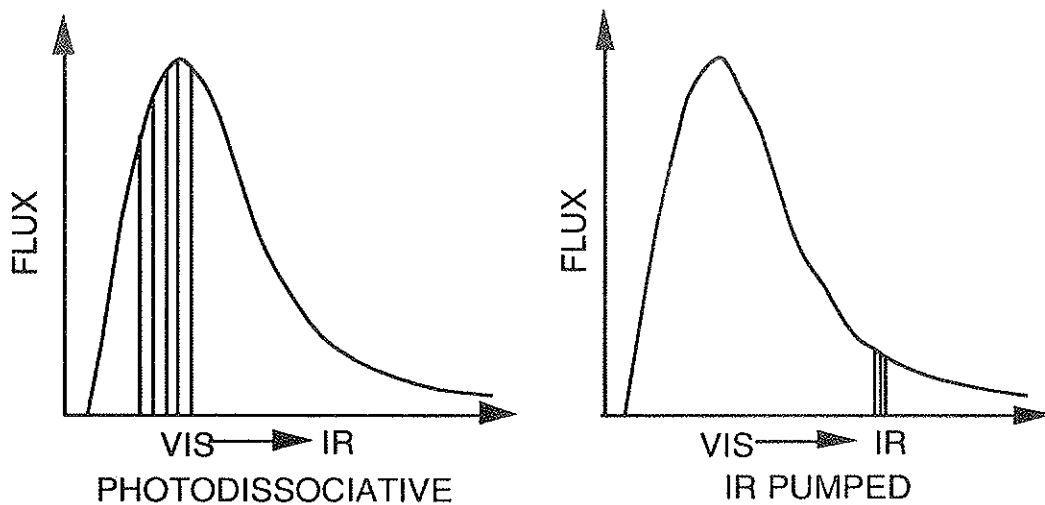

Figure 7.33 Examples of Optical Pumping Lines in Solar Energy. [Taussig, 1979]

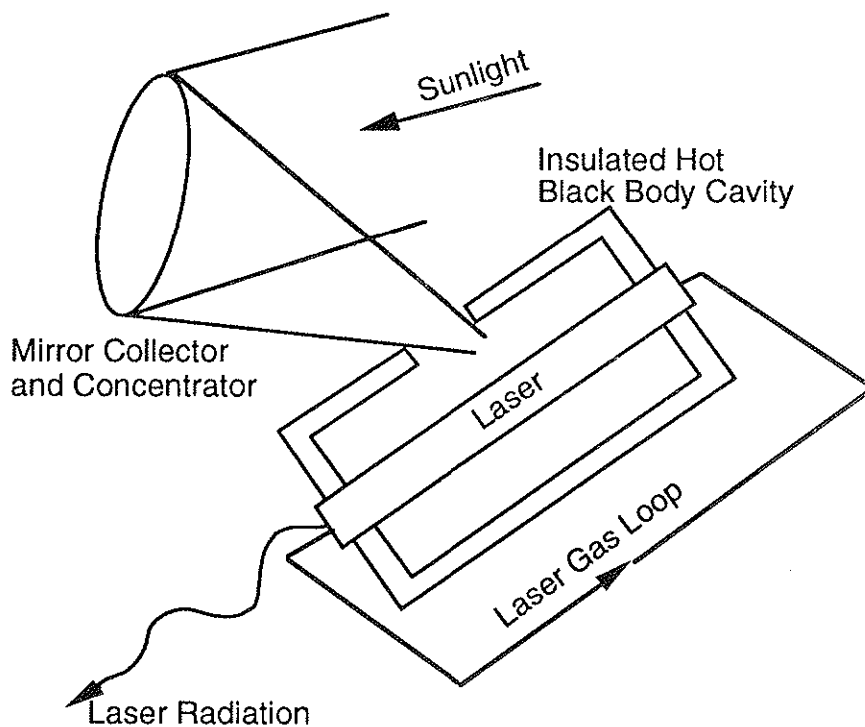

Figure 7.34 Indirect Solar Pumped Laser. [Walbridge, 1980]

An indirect solar pumped laser is one possible way to avoid the inefficient use of solar energy. Solar energy is stored to a black body and the laser is pumped by blackbody radiation shown in Figure 7.34. Walls of the black body emit radiation in spectral distribution depending on the temperature of the black body. Temperature range required for wavelengths used for laser pumping is 2000-3000 K. The laser absorbs much of pumping wavelength from radiation passed through laser. Rest of the radiation spectra is then absorbed by other wall of the black body shown in Figure 7.35. [Beverly, 1980c][Taussig, 1979][Walbridge, 1980]

The efficiency of an indirect solar pumped laser can rise very close to the theoretical value of the laser. The factors to decrease the efficiency are the energy required for cooling and the leak emission of the black body.

The solar pumped laser is a good alternative because it do not need any solar energy converter. However it requires quite large reflectors. The indirect solar pumped laser can operate with much smaller reflector because it uses larger fraction of solar spectrum. The overall mass of this laser type can be smaller than its competitors. So far this laser type has been only investigated in initial state.

Free Electron Laser

The Free Electron Laser (FEL) uses an electron beam passing through periodically modulated magnetic field. In this magnetic field some of the energy of the electrons is converted to electromagnetic wave energy. This wave is reflected between two mirrors so the wave travels along and against the electron beam. The wave acquires energy while traveling along the electron beam but it does not acquire nor loss energy while traveling against electron beam. The total effect of reflections is photon amplification

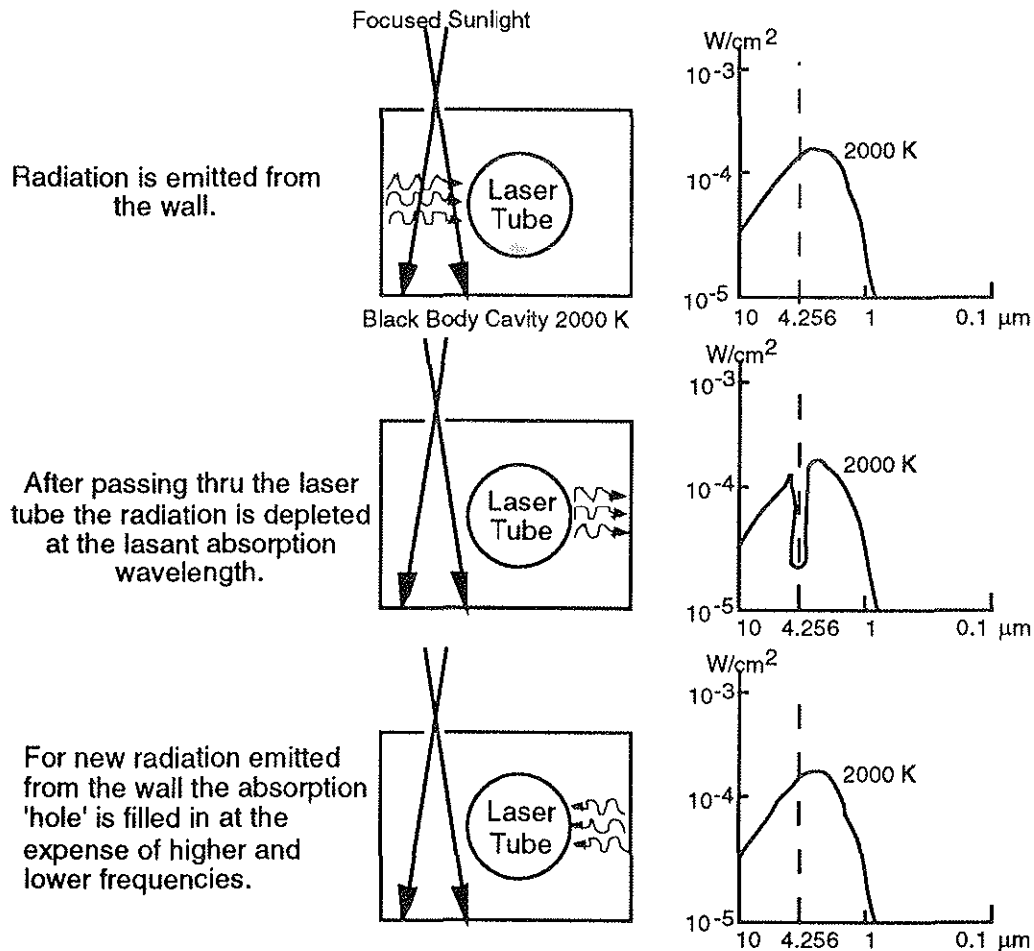

Figure 7.35 Operation of Indirect Solar Pumped Laser. [Walbridge, 1980]

The frequency of the amplified wave depends on the speed of entering electrons into the magnetic field. This phenomenon means that the FEL is tunable. Another advantage is its efficiency. Over 50% extraction of light energy from the electron beam should be possible as explained in paper from Boeing, 1980. The lasant of the FEL is an electron beam contained by magnetic field. Due to this there is no need for an output window. The output radiation can exit through a hole in one of the mirrors and both mirrors may be 100% reflective and thus avoid absorption in partially reflective mirror used in other types of lasers.

Although this laser type has many advantages, it is not yet fully developed. The equipment for a magnetic field required to keep the electron beam under control may be very heavy. Development of superconductive materials may help to develop also this laser. [Walbridge, 1980][Boeing Aerospace, 1980]

Chemical Laser

In this laser type the energy to molecules is produced by chemical reaction. An example is hydrogen fluoride (HF) laser that has a reaction shown in table 7.2. Another possible chemical lasant is deuterium fluoride (DF). Efficiency for an HF laser is 2.5-3.0% and for a DF laser 3.5-4.0%.

Table 7.2 Chemical Reaction in Hydrogen Fluoride Laser

$H + F_2$	$\rightarrow HF^* + F$
$F + H_2$	$\rightarrow HF^* + H$
$HF^* + h\nu$	$\rightarrow HF + 2h\nu$

The third reaction shows that a photon stimulates the HF* (energized HF molecule) to emit a second photon of the same frequency. A chemical laser consumes fuel and oxidizer and produces reaction product. The laser is operable only until fuel and oxidizer is consumed. A space chemical laser has to be closed cycled so that fuel and oxidizer can be reproduced from the reaction product. This reproducing can be accomplished by electrolysis or by direct sunlight. Although this laser type is possible in principle, it has not yet been developed. [Walbridge, 1980]

Laser Diode Array

A Solid State Laser uses semiconductor technology to produce the laser beam. The power conversion and density capability of this type of laser is quite low. Separate diodes can be formed as an array and phase locking their beams together the output power can be increased.

The state of art laser diodes are quite unreliable, inefficient and their life time is low. Technology developments to get pure materials can improve their feasibility. A laser transmitter might then be produced as a diode matrix in a same way as the phase array antenna. If a phase shift between different diodes would somehow be possible the laser beam could be also pointable to different power receiving sites.

Transmission

Electromagnetic radiation loses energy in plasma through linear (ohmic) and nonlinear (anomalous) absorption. Beverly has studied this absorption in his paper for an intense laser beam propagating in upper atmosphere. In altitudes of 120 km to 340 km the absorption by plasma is 0.17 nW/m^3 at maximum using a 100 MW, $5\mu\text{m}$ laser beam. As plasma has maximum density in altitudes of 200-500 km the absorption due to plasma in space is negligible. [Beverly, 1980b]

Laser beaming from space to earth is attenuated mainly by atmosphere. Clear air propagation can be very effective with proper selection of wavelength but haze, fog, clouds and rain can attenuate the beam. Most of the attenuation occurs at altitudes below 0.5 km so reception site should be above this altitude. The attenuation by atmosphere can be either linear or non-linear. Linear attenuation is independent of the beam intensity while non-linear depends on beam intensity.

There are some spectral windows on which the attenuation is very low. The molecular absorption is almost negligible for $2\mu\text{m}$ and $11\mu\text{m}$ wavelength bands at high altitudes. In low altitudes even a light fog and light cloud cover cause an increase on the molecular absorption for $11\mu\text{m}$ wavelength. At altitudes of 0.5 km the yearly average transmission efficiency for $9.114\mu\text{m}$ ($^{12}\text{C}^{18}\text{O}_2$) laser is estimated to be 93% and at altitude of 3.5 km some 98%. These values represent clear summer air when laser output wavelength is optimized to molecular absorption. During winter time the air is dryer and these figures may be even slightly better.

Hole boring through monodisperse and polydisperse aerosols has been proposed and studied by many authors. These studies have been both theoretical and experimental. The method would be used to generate a clear path for laser beam through certain types of hazes, fogs and clouds. For lasers operating in the $11\mu\text{m}$ window, power densities of $100\text{-}200 \text{ W/cm}^2$ are required. This density is below the weapon-quality densities of 1 kW/cm^2 but it is much more than safety

standards accept. Continuous wave laser beam of $2 \mu\text{m}$ is not capable of hole boring unless superimposed with a train of short duration pulses of about 100 kW/cm^2 . [Beverly, 1980e]

Many studies have been made for aerosol scattering, absorption and excitation coefficients for various types of clouds and rain and snow distributions. Furthermore, seasonal and annual power availabilities and transmission frequencies have been studied on different locations over USA. [Beverly, 1980e]

The total efficiency of power transmission from space to earth is highly affected by the availability of the beam and attenuation in atmosphere. To avoid wasting of available power there has to be many power receiving sites in view of the power satellite. If possible these receiving sites should have different kinds of weather probabilities. When the received power in receiving site reduces below some threshold level the power beam has to be refocused to another receiving site. The selection of the threshold level effects greatly to the total effectiveness. The threshold level is not only depending on the transmission efficiency but also on the time the transmission effectiveness exceeds some useful value. [Beverly, 1980d]

Laser Receiver

Laser energy receiver and converter may be either energy to electricity converter as photovoltaic cell or it may transfer the laser energy to heat. Heat can then be converted to mechanical energy and further to electricity. This section discusses first conversion to heat and on the second sub-section conversion to electricity or mechanical energy.

Receptors

Heat exchanging devices need very highly concentrated laser radiation. Concentrating optics is not desirable since the environmental effect will decrease the reflectivity and large high power density reflectors are very expensive. To avoid optical concentrator, the laser spot on receiver site should be reduced as small as is possible considering the effect of diffraction, turbulence, thermal blooming, pointing accuracy and jitter. However reduced spot requires very dense power beam that in turn may cause other problems.

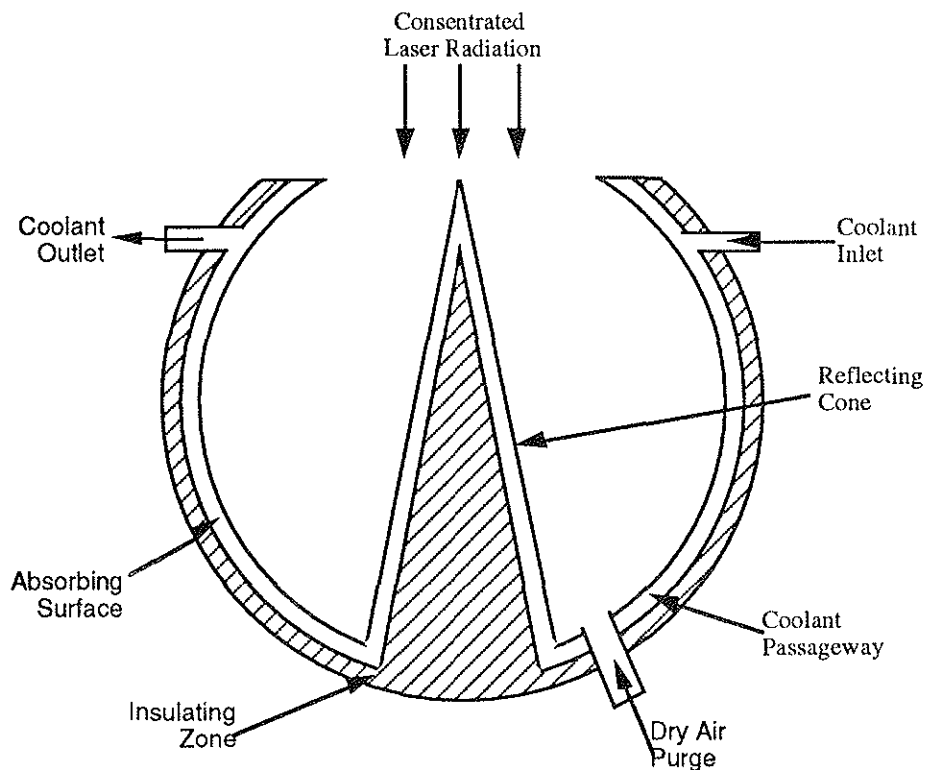

Figure 7.37 Absorbing Sphere Concept

The absorbing surface on receiving spot should have a high absorptance and a small hemispherical emittance. A device made of a dense forrest of aligned metal whiskers have been demonstrated. The diameter of these whiskers is of the order of incoming radiation and their spacing is several wavelengths. This device has an efficiency of 98% and a hemispherical emissivity of 0.26 at 550 °C over a wavelength range of 0.5-40 μm using tungsten. Another method to maximize the absorption of incoming radiation is an open sphere with a cone heading to the entrance opening of the sphere shown in Figure 7.37. The meaning of a cone is to minimize the escape of re-radiated energy. Convective losses due to air heating are minimized by purging dry air.

Converters

Photovoltaic cells for infrared have been researched and Mr. Beverly mentions two candidates 50% efficiency in his paper with. These are mercury-cadmium-telluride for 4-18 μm and lead-tin-telluride for 4-13 μm . Their lifetime and stability in different weather is uncertain. Another semiconductor device for infrared mentioned by Mr. Beverly is a tuned optical diode. This is an infrared analog of the microwave rectenna diode. Its power handling capability is very low and there is no experimental effectiveness determined. In paper written by Boeing Aerospace is mentioned an optical rectenna that is an entirely analogous to the microwave rectenna. It consists of microminiature 10 μm wavelength dipole antenna and rectifier elements as shown in Figure 7.36. In paper written in Boeing Aerospace it is approximated that efficient operation requires intensities of almost gigawatts/ m^2 to overcome forward voltage drop in the rectifying diode. This amount of intensity can be easily reached with pulsed laser beam and using efficient optics to amplify the laser beam. Another way to increase the voltage level is fabrication of antenna elements with gain. The optical concentrator could be eliminated with a gain as low as 20 db. [Beverly, 1980a][Boeing Aerospace, 1980]

The thermoelectric laser energy converter (TELEC) generates electricity by collecting electrons diffused out of the plasma. Electrons are energized by absorbing laser energy through inverse bremsstrahlung. Electrons are collected using different area and temperature for anode and cathode. Theoretical efficiency using 10.6 μm laser beam is above 42% but experimental values are much lower. Device scaling has been considered to improve the efficiency but laser window limitations may cause a problem. The cell vapor may condense on the surface of the window and reduce the energy density on plasma. [Beverly, 1980a]

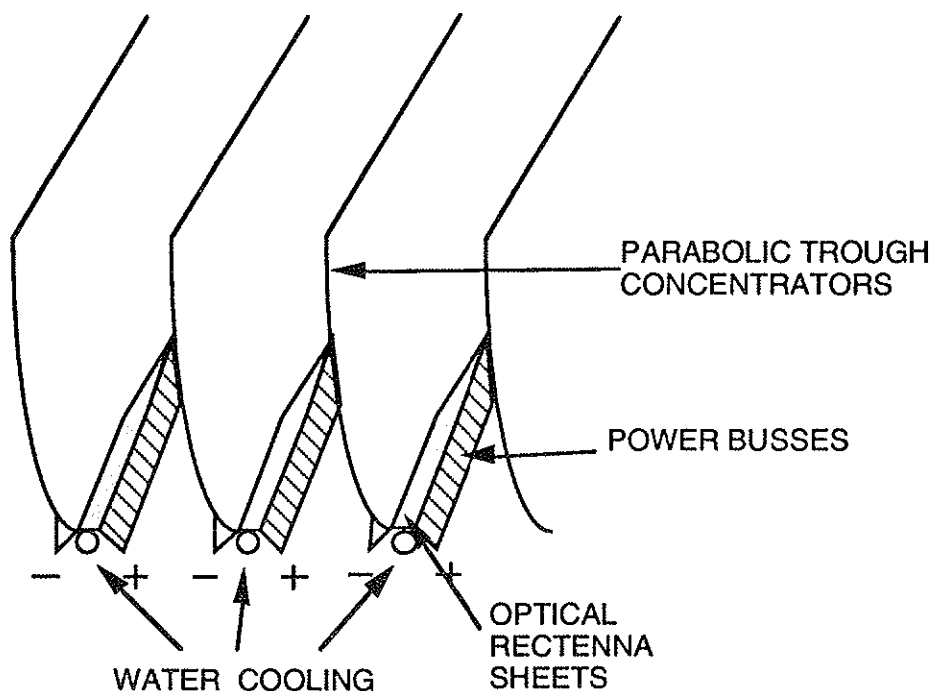

Figure 7.36 Optical Rectenna Configuration. [Boeing Aerospace, 1980]

The most experienced conversion system is a boiler heat engine. Other possible heat engine types are laser and photon engines that absorb the energy into working gas. The main problem with these engines is the lack of the appropriate window materials. Quite different group of heat engines uses energy exchanger. In these energy is directly exchanged between high temperature and low temperature fluids so wall temperature of the machine is an average of these temperatures. Temperature ratios may be even 10 using high and low molecular weight fluids as hot and cold working fluids. The theoretical efficiency for energy exchanger/binary cycle concept as been calculated to be 73%. This requires however very high temperatures that cause some problems with materials. [Beverly, 1980a]

Laser Applications

Laser Beamed Power To Photovoltaic Receivers

One of the most interesting and promising uses of laser beamed power transmission is a laser beam on earth to transmit power to a remote photovoltaic array [Landis, 1991]. This new concept was recently proposed by Landis and Rather working independently. The laser power could be transmitted to any of several existing orbiting spacecraft such as satellites, or future space systems such as Space Station Freedom or a lunar base system. By using an existing spacecraft, the laser beaming concept could be promising for a near term and low budget demonstration. Placing the laser on earth has several obvious cost advantages. Currently, earth based lasers are easier to develop and maintain for ground operations. High power lasers can operate for only short periods of time without operator intervention. Secondly, the earth environment is less destructive to the laser system hardware than a space environment. The space environment has extreme temperature variations and ionizing radiation that can adversely affect the hardware. Finally, because power on earth is much less expensive to provide than power in space, the mass and the power efficiency of the laser system is relatively unimportant for a laser demonstration.

Photovoltaics can have extremely high efficiencies for conversion of monochromatic (laser) light at selected wavelengths. The peak responses to monochromatic illumination of existing solar cells is 850 nm for gallium arsenide (GaAs) and 950 nm for silicon. Using IR wavelengths in the "eyesafe" range will have considerably less stringent safety restrictions; unfortunately the efficiency of photovoltaic receivers begins to drop off considerably at longer wavelengths near the "eyesafe" range. Because of the trade-offs in wavelength selection (i.e., atmospheric attenuation and biological constraints), the best laser choice may be a free electron laser (FEL), which has been operated between about 100 Angstroms and 10 mm. The output wavelength of an FEL can be chosen by adjusting one of three macroscopic parameters: the electron energy, the "wiggler" period or the field strength.

Free electron lasers (FELs) operate inherently in a pulsed mode. The pulses may be very short and the pulse rate high enough so that the laser system can achieve sufficient average power for the solar cells. For induction FELs, the peak power may be higher than the average power. Therefore, it is important that the photocells on the receiver be able to operate under high-peak power with a minimum of cell degradation. The characteristic response time of a photovoltaic cell to pulsed excitation from the laser is related to the minority carrier lifetime. The response time is often shorter than the period between laser pulses. With this characteristic, for optimum use and efficiency, the solar cells used with the induction FEL should have a lower series resistance than standard non-concentrator solar cells to minimize I^2R losses (power dissipation).

In conclusion, the most important technical issues which should be addressed for a high efficiency laser power transmission to photovoltaic receiver system are:

Radiation Damage: The orbit selection will effect the amount of radiation damage to a solar cell. In low earth orbit (LEO), there is relatively low radiation and any solar cell type is acceptable. In geosynchronous orbit, there is moderate radiation where a standard silicon solar cell could be used with a coverglass and be subject to moderate degradation. In transfer orbit, there are high doses in the radiation belts where a standard silicon or gallium arsenide cell should be protected with a thicker cover glass for radiation protection.

Pulsed Mode Operation: Solar cell operation and power management systems must be able to operate in a pulsed mode. The system efficiency can vary with the pulse peak, pulse width and duty cycle. For high peak power operation, the solar cell must be designed with high metallization coverage and a prismatic cover glass.

Solar Cells Operation: A solar cell must be chosen to match the wavelength of the laser. Operation in the eyesafe range (1700 nm) requires the use of PV material such as Si and InGaAs. The thermal environment will also affect the solar cell response. Therefore, solar cells with adverse response to high temperatures may require better thermal management systems than their current standard systems.

Conclusion

Laser technology is a good alternative for power beaming in principal. The divergence of the laser beam is minimal, only few arc seconds. The efficiency of state of art laser technology is however quite low. There is some possibilities to increase this efficiency. Another problem is their large mass, typically few tons for lasers capable to produce high power beams. Improvements in solid state technology may also reduce the mass of overall system below 300 kg. The atmospheric attenuation and instability for available laser wavelengths causes a problem for space to earth power transmission. Space to space transmission might become very feasible because of small scale transmission and receiving units.

Taking into account these requirements even a demonstration using laser technology is not feasible at the moment. Laser power transmission may however become very feasible for space to space power transmission in few decades. Very promising technologies at moment seem to be the Free Electron Laser and the Solid State Laser. Especially Diode Array may be used at same manner as a phase array antenna for microwaves.

7.3 Receiver Location

The choice of receiver location is heavily dependent both on the type of transmission that is used and on the orbit of the power beaming satellite. While receiving microwaves requires a huge area for the rectenna, but is relatively independent of the weather, receiving laser beams does not require very much space, but on the contrary it is sensitive to the weather conditions. The altitude and inclination of the satellite orbit will determine the maximum latitude at which a receiver site can be built.

To make space solar power attractive for the electricity companies, it is important to have the rectenna site as close as possible to the consumers and to maximize the use of existing infrastructure for the distribution. Depending on whether the receiver receives power continuously or not, energy storage may have to be accommodated at the receiver site.

Another important aspect of the receiver location is the amount of ground preparation that is required. For a microwave rectenna it is necessary to have available an area with a diameter of more than 10 km of plain ground. Although a certain degree of irregularity could be accepted, keeping the construction costs down would exclude building the rectenna in mountain areas. If the ground is swampy or the weather is extremely windy special measures would be required as well.

To guarantee that no people in the vicinity of the receiver site are exposed to radiation above what is a permissible level, a buffer zone will have to be added around it. In the case of microwave transmission, the size of the buffer zone will depend on how much of the beam that is intercepted by the rectenna as well as of the size and intensity of the side lobes. Due to economical reasons, it is not worthwhile to build a rectenna that covers all of the incoming beam, so some of the energy will be wasted. The buffer zone would have to be large enough so that people will not be able to come close to where the beam intensity exceeds the safety limits for microwave exposure. In the case of laser transmission, the size of the buffer zone will probably be determined by the pointing accuracy of the laser and the time to turn it off if it should become misdirected. For both microwave and laser transmission it may be advisable to extend the buffer zones to the air space around the receiver sites.

It is desirable, and it could be a requirement, that the impact of the receiver on the environment is as small as possible, especially considering the size of the receiver in the case of microwave transmission. If wire reflectors are used to focus the radiation onto the rectenna elements, the rectenna becomes almost transparent to sunlight. Then the effect of the rectenna on the vegetation beneath it would be rather limited and potentially the ground could be used for agriculture. From a maintenance aspect, it is important to also consider the impact of the

environment on the receiver. Considering the size of the rectenna, it is essential that the design is robust enough not to require frequent maintenance. Environmental degradation might be caused by storms, floods, snow, ice, natural disasters, etc. Except for flying creatures, such as birds and insects, laser will probably have little effect on the environment in the vicinity of the receiver site. On the other hand, the environment in the form of the weather could become a show stopper for using laser in many parts of the world, as cloudy weather would repeatedly interfere with the power transmission.

A DOE study was made to identify suitable rectenna sites in the USA [DOE, 1980]. As suitable for a rectenna site was defined a square with a side-length of 26 km, which did not have to be excluded due to any of the following parameters

- Federal lands (national recreation areas, Indian reservations, military reservations)
- Population (high density areas with more than 50 people per square mile)
- Marsh vegetation
- Wetlands
- Topography unacceptable (hills, mountains, valleys)
- Navigable waterways
- Interstate highways
- Endangered species' habitats
- Land in cultivation
- Seismic hazards
- Latitudes higher than 40 degrees
- Windstorms (2% probability of wind speeds higher than 50 knots)
- Weather (thunderstorms, sheet rainfall, acid rainfall)

The result is shown in Figure 7.38. In parallel a similar study was made by ESA [ESA, 1980]. As it would be almost impossible to find enough land for a rectenna site in western Europe, it was decided to investigate the possibility of building the rectenna offshore. The areas in the North Sea with a water depth less than 30 m that would be suitable for offshore rectenna sites are marked in Figure 7.39.

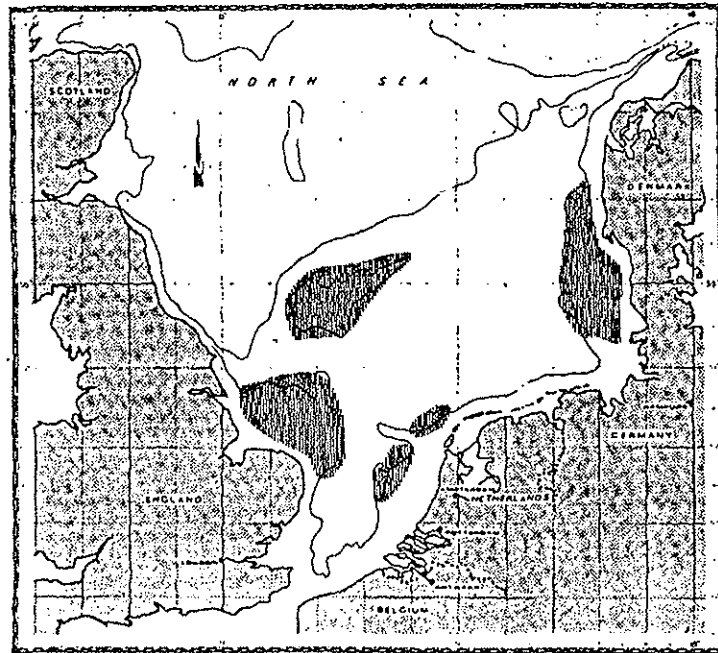

Figure 7.39 Possible Offshore Rectenna Sites in the North Sea [ESA, 1980].

They are all more than 20 km from the coast but less than 300 km from major consumer concentrations. The preferable solution would be to construct a polder as shown in Figure 7.40. The construction costs have been estimated to between US\$ 4.8 and 5.4 billion. Operation and maintenance of the polder would cost US\$ 35 million per year.

It appears that selecting a receiver site may become both a difficult and probably controversial undertaking. Selecting suitable receiver sites close to the consumers and at the same time at a distance which will eliminate the risk of exposing people to harmful radiation at the outskirts of the receiver site will require careful consideration. A possible but rather expensive alternative would be to build the receiver off shore. The costs could be reduced if secondary uses for the offshore site could be found.

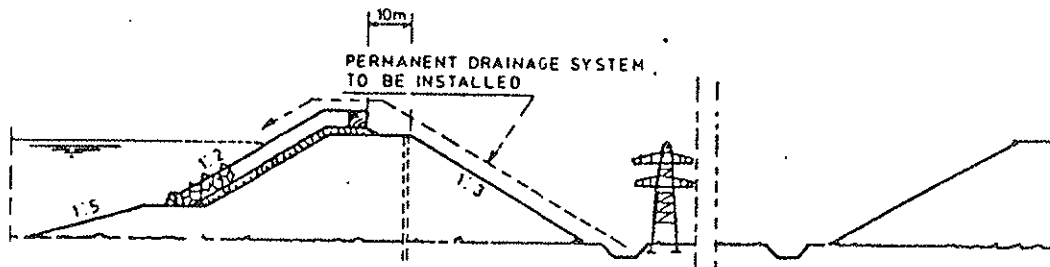

Figure 7.40 Preferred Construction for Offshore Rectenna Site [ESA, 1980].

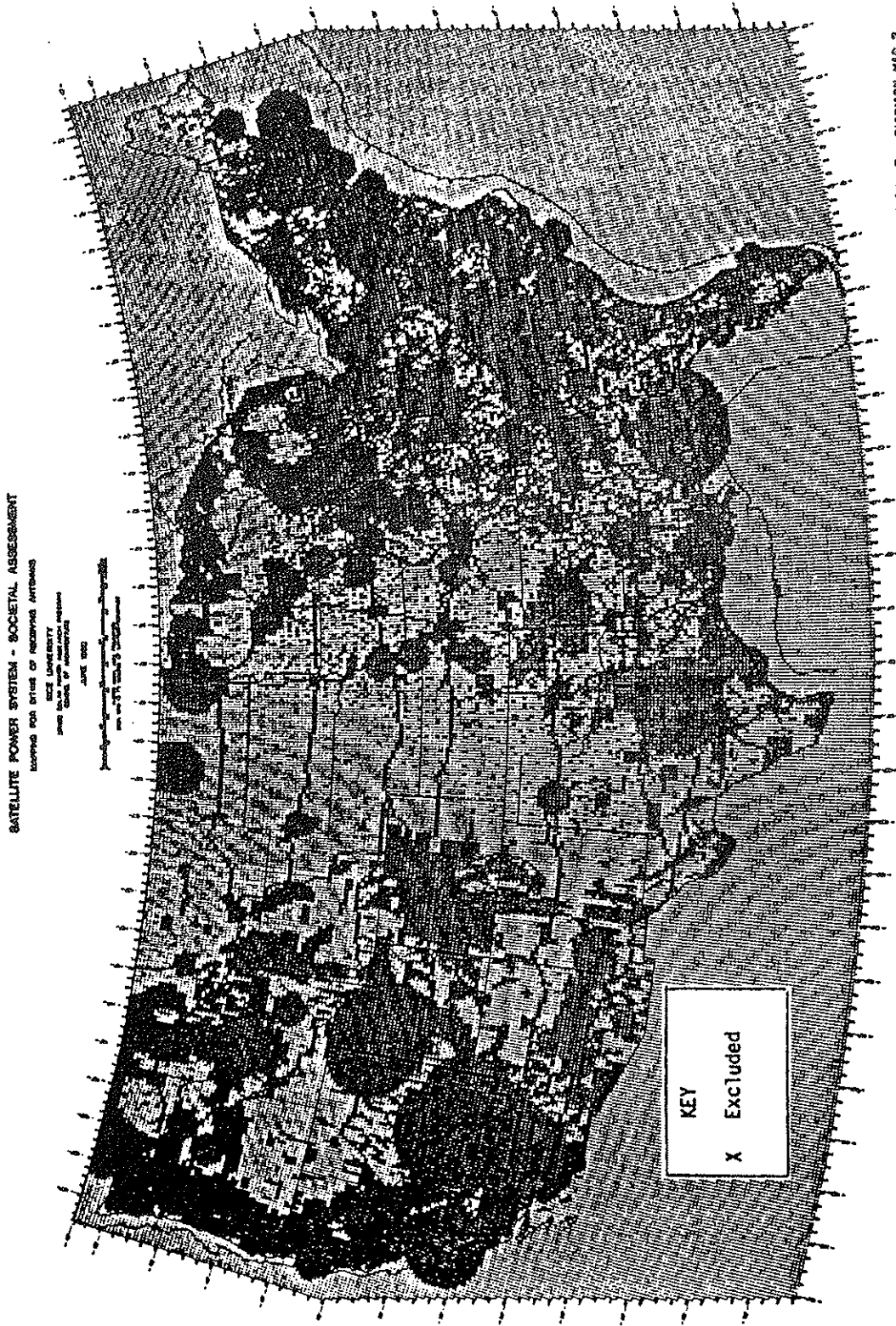

Exhibit 2 SUMMARY MAP 2

Figure 7.38 Possible Rectenna Site Locations in Continental United States [DOE, 1980].

7.4 Power Systems for Demonstrations

As discussed in previous sections, the state of art power collection and beaming technology is quite inefficient and heavy. Therefore, better systems must be developed for cost justification and environmental compatibility. To achieve this goal, technologies for solar energy collection, energy beaming and receiving must be developed efficiently and systematically. To approach this goal some intermediate steps using a short term demonstration are discussed in Chapter 10. Once these steps are complete, a demonstration of the entire power system can be built as presented in Figure 7.41. These system demonstrations can then be used to generate more sophisticated power plants in space as presented in Figure 7.42.

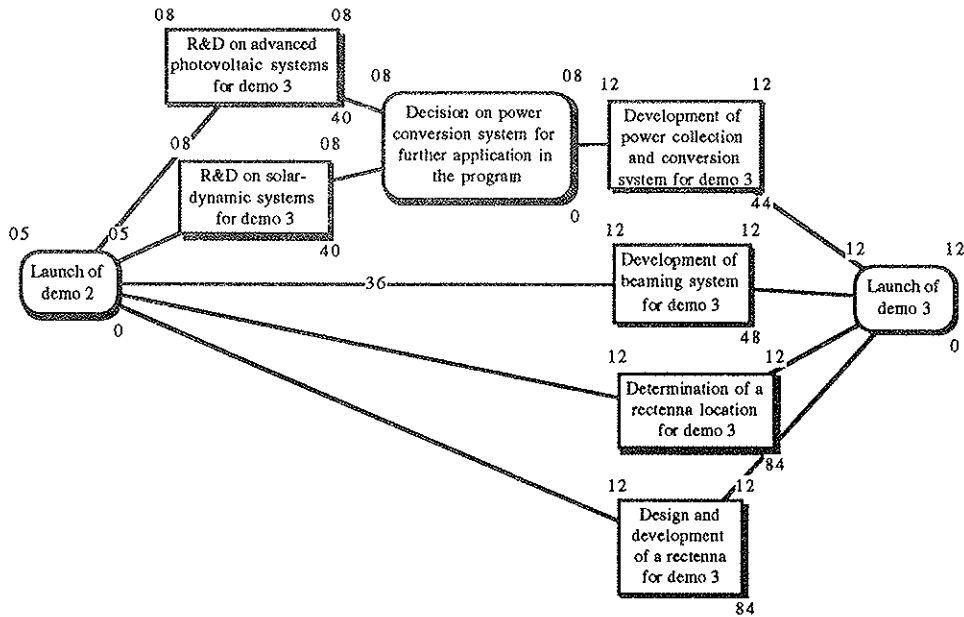

Figure 7.41 Schedule Tasks for Power Systems - Demo 3

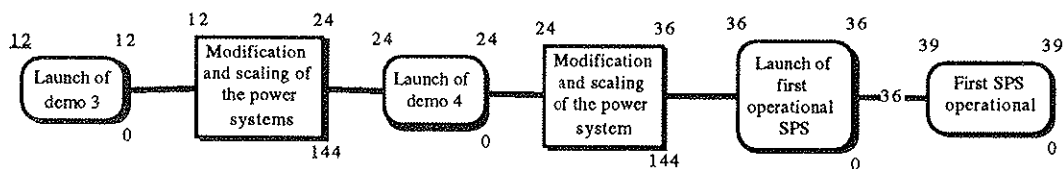

Figure 7.42 Power System Tasks For Large Scale Demo

References

- Angrist S.W., Direct Energy Conversion Fourth Edition, Allyn and Bacon, inc, (page 145), 1982
- Bailey S., Space Solar Power Project, The International Space University, August, 1992
- Bailly Du Bois, Preliminary Plan for a 20 kW space solar "Gyroreactor", SPS 91, 1991
- Beverly R.E., Satellite Power Systems (SPS) Laser Studies. Laser Environmental Impact Study, NAS8-32475, Volume I, pp 2.29-2.32, 1980a
- Beverly R.E., Satellite Power Systems (SPS) Laser Studies. Laser Environmental Impact Study, NAS8-32475, Volume I, pp 4.5-4.11, 1980b
- Beverly R.E., Satellite Power Systems (SPS) Laser Studies. Meteorological Effects on Laser Beam Propagation and Direct Solar Pumped Lasers for the SPS, NAS8-32475, Volume II, pp 1.3-1.6, 1980c
- Laser Beam Propagation and Direct Solar Pumped Lasers for the SPS, NAS8-32475, Volume II, pp 1.39-1.56, 1980d
- Beverly R.E., Satellite Power Systems (SPS) Laser Studies. Meteorological Effects on Laser Beam Propagation and Direct Solar Pumped Lasers for the SPS, NAS8-32475, Volume II, pp 2.1-2.20, 1980e
- Boeing Aerospace Company, Solar Power Satellite System Definition Study, Phase III, Final Report, Boeing Aerospace Company, P.O.Box 3999, Seattle, Wash. 98124, Volume 3, 1980
- Brown W., Status of Microwave power transmission components for the Solar Power Satellite , IEEE trans. on MIT-29, pp. 1319-1326, 1984
- Brown W.C., Electronic and mechanical improvement of the receiving terminal of a free-space microwave power transmission system, NASA Report CR-135194, 1977
- Brown W.C., The History of Power Transmission by Radio Waves, IEEE Trans. on Microwave Theory and Tech., v MTT-32, p1230-1242, Sept, 1984a
- Chabb D.L. et. al, High efficiency thermal to electric energy conversion using selective emitters and spectrally tuned solar cell, 1992
- Collins P.Q., Design considerations for the "SPS 2000" ground segment, SPS 91 Power from Space, p364-372, 1991
- DOE, 1980, Satellite Power System (SPS) Rectenna Siting: Availability and Distribution of Nominally Eligible Sites, Rice University, TX, USA for US Department of Energy under contract AC01-79ER10041, DOE:NASA Satellite Power system Concept Development and Evaluation Program, DOE:ER:10041-T10, November, 1980
- Duffie J., Beckman W., Solar Engineering of Thermal Processes, Chapter 8, 1990
- Dustin M., Advanced Space Solar Thermal Power, Presentation to IAPG 1992 Spring Symposium, 1992
- Eguchi K., Introduction to Power Sources and Thermal Management, International Space University Lecture, 1992
- Elachi C. et al., Spaceborne Radar Remote Sensing: applications and techniques, vol.2, Addison-Wesley, 1982
- ESA, 1980, Study of Infrastructure Considerations for Microwave Energy Ground Receiving Stations (SPS Offshore Rectenna Siting Study in West Europe), Hydronamic B.V., Slidrecht, Netherlands under ESA contract 4382, November, 1980
- Fordyce J., Thermal to Electric Space Power Systems, International Space University Lecture, 1992
- Harper W., Pietsch A., Baggenstoss W., The Future of Closed Brayton Cycle Space Power Systems, Space Power, Vol 8, No 1:2, 1989
- Japan External Trade Organisation, JETRO, New Technology Japan, J, 1991
- Kaya et al., METS Rocket Experiment. Microwave Energy transmission in Space, SPS 91, 1991
-

- Kaya N., Matsumoto H., Akiba R., Rocket Experiment METS - Microwave Energy Transmission in Space, SPS 91 Power from Space 2nd International Symposium, 1991
- Landis G., Photovoltaic Receivers for Laser Beamed Power in Space, NASA Contractor Report, December, 1991
- Landis G., Integrated Solar Power Satellites: An Approach to Low-mass Space Power, SPS 91 Power from Space 2nd International Symposium, 1991
- Landis G.A., Bailey S.G., Flood D.J., Advances in Thin-Film Solar Cells for Lightweight Space Photovoltaic Power, Space Power Vol.8 Number 1:2 1989, p35-37, 1989
- Landis G.A., Hepp A.F., Thin-Film Photovoltaics: Status and Applications to Space Power, Proceedings of the European Space Power Conference held in Florence, Italy, 2-6 September 1991, p518, 1991
- Manheimer W., Gold S., Seo Y., The Magnicon as a Highly Efficient, High Power, High Frequency Source for Space Power Beaming, SPS 91 Power from Space 2nd International Symposium, 1991
- Nozette S.D., Solar Power From Space Revisited: A Fresh Look Based on Emerging Concepts, Architectures, and Technologies, Presented to International Space University, June, 1992
- Ralph, E.L., Photovoltaic Space Power History and Perspective, Space Power Vol.8 Number 1:2 1989, p7, 1989
- Raney R.K. et al., Radarsat, Proceedings of the IEEE, Vol 79, June, 1991
- Rockwell International, SPS Concept Definition Study, Systems Subsystems Analyses. Final Report. Vol. II, Rockwell Int., 1980
- Rybakov V. et al., Frequency range analysis for power transmission by electromagnetic beam, SPS'91. Power from space, pp.548-550, august, 1991
- Schroeder et al., The Resonant cavity Radiator (RCR), Rockwell, 1980
- Taussig R. et al., Design Investigation of Solar Powered Lasers for Space Applications, NAS3-21134, Final Report, May, 1979
- Ulaby F.T. et al., Microwave remote sensing, vol.2, Addison-Wesley, 1982
- Walbridge E.W., Laser Satellite Power Systems, Argonne National Laboratory, 9700 South Cass Avenue, Argonne, Illinois 60439, pp 14-25 January, 1980
- White A.K., Liquid Droplet Radiator Development Status, NASA Technical Memorandum 89852, 1987
- Woodcock G., Solar Power Satellite Power Transmission System Description. Executive Summary., DOE:NASA, 1980
-

