

The Final Proceedings of the Solar Power Satellite Program Review

**April 22-25, 1980
Lincoln, Nebraska**

**Sponsored by:
U.S. Department of Energy
Office of Energy Research
Solar Power Satellite Project Division
Washington, D.C. 20585**

**Coordinated by:
The University of Alabama in Huntsville
The Kenneth E. Johnson Environmental and Energy Center
Huntsville, Alabama 35807
Under Contract No. FG05-79ER10116**

July 1980

**DOE/NASA
Satellite Power System
Concept Development
and
Evaluation Program**

ACKNOWLEDGEMENT

It is impossible to acknowledge all of the people and organizations who contributed to the success of the program review. We appreciate the efforts of all who participated in the review as speakers, listeners and staff. The program and the CDEP process could not have been accomplished without your support.

Frederick A. Koomanoff

Michael R. Riches

INTRODUCTION

The concept of a solar power satellite (SPS) was first proposed in an article by Dr. Peter Glaser in the November 11, 1968, issue of *Science*. The intervening 12 years have seen this idea—placing gigantic satellites in geosynchronous orbit to capture sunlight, changing the energy into an appropriate form for transmission to earth, and introducing the energy into the electrical power grid—expand beyond the scientific community and capture the imagination and interest (pro and con) of others as a source of renewable energy for the 21st century.

To study SPS, its costs and benefits, the Concept Development and Evaluation Program (CDEP), was initiated by the Department of Energy (DoE) in cooperation with the National Aeronautics and Space Administration (NASA) and other government agencies in 1977. It will conclude in the fall of 1980 with recommendations for future research consideration.

The CDEP has been conducted in four general areas—Systems Definition, Environmental, Societal and Comparative Assessments.

Systems Definition is to continually define and refine the proposed solar power satellite. Transportation, construction in space, methods of conversion of sunlight into energy, transmission to earth, maintenance in orbit and decommissioning of satellites—all fall under this heading.

The Environmental Assessment is currently studying the impact of SPS on our environment. The Societal Assessment is doing the same for the political and economic effects on our society.

Finally, the Comparative Assessment is comparing SPS to other forms of power generation, both terrestrial and in space.

The Solar Power Satellite Program Review, sponsored jointly by the Department of Energy and the National Aeronautics and Space Administration, held April 22-25, 1980, at the Nebraska Center on the campus of the University of Nebraska - Lincoln, was organized similarly to the CDEP. After initial overview presentations, the meeting divided into the four sessions for more in-depth presentations.

Frederick A. Koomanoff, Division Director of the Solar Power Satellite Project Division, was Program Chairman assisted by Michael R. Riches, both of the Department of Energy.

Session Chairmen were as follows: Systems Definition, F. Carl Schwenk, National Aeronautics and Space Administration; Environmental Assessment, Anthony R. Valentino, Argonne National Laboratory; Societal Assessment, Charles E. Bloomquist, Planning Research Corp.; Comparative Assessment, Michael R. Riches, Department of Energy.

The Review was coordinated by The Kenneth E. Johnson Environmental and Energy Center of The University of Alabama in Huntsville. Hosting the Review at the Nebraska Center was the Division of Continuing Studies of the University of Nebraska - Lincoln.

The Program Review was designed to allow a free exchange of information and opinions. Responsible opinions were welcome, and even solicited, from all quarters, in an effort to allow the broadest spectrum of ideas to be aired. Many special interest groups were invited and encouraged to attend and participate.

The Review's organization was quite complex: at times eight meetings were being conducted simultaneously. The extended abstracts were arranged in their order of presentation within their respective subject areas, therefore the Agenda¹ is not included herein. Abstracts of papers² were preprinted and distributed at the Review.

A list of frequently used acronyms follow. A glossary of SPS terms is included at the end of this document. A few papers are included in these proceedings which were submitted, but circumstances prevented the author's attendance at the meeting.

¹ Department of Energy/National Aeronautics and Space Administration. *Final Agenda*. The University of Alabama in Huntsville, Huntsville, AL. 1980.

² Department of Energy/National Aeronautics and Space Administration. *Abstracts of Presentations*. The University of Alabama in Huntsville, Huntsville, AL. 1980.

SOLAR POWER SATELLITE ACRONYMS

ASET	Assistant Secretary for Energy Technology/DoE	FCC	Federal Communications Commission
ASEV	Assistant Secretary for Environment/DoE	GBED	Ground-based exploratory development
CDEP	Concept development and evaluation program. A four-year program being conducted by the Department of Energy, assisted by NASA, to continually define a reference-concept SPS and evaluate it.	GEO	Geostationary orbit
COE	Cost of electricity	GHz	Gigahertz (10^9 cycles per second)
DBER	Division of Biomedical and Environmental Research/ASEV	GW	Gigawatt (10^9 watts)
DDT&E	Design, development, test and evaluation	HLLV	Heavy-lift launch vehicle
DECT	Division of Environmental Control Technology/ASEV	IAF	Internationale Aeronautique Federique
DoD	Department of Defense	IPTASE	Interagency Panel on the Terrestrial Applications of Solar Energy
DoE	Department of Energy	IR	Infrared. Designating or of those invisible rays just beyond the red of the visible spectrum: their waves are longer than those of the spectrum colors but shorter than radio waves, and have a penetrating heat effect.
DOES	Division of Operational and Environmental Safety/ASEV	JSC	Johnson Space Center
DTO	Division of Technology Overview/ASEV	KSC	Kennedy Space Center
EH&S	Environment, health and safety	LEO	Low earth orbit
ELA	Environmental impact assessment	LOX	Liquid oxygen
EMI	Electromagnetic interference	MHD	Magnetohydrodynamics
EPRI	Electric Power Research Institute	MPTS	Microwave power transmission system
ERDA	Energy Research and Development Administration (one of the agencies preceding and absorbed into DoE on October 1, 1977)	MSFC	Marshall Space Flight Center
ES	Earth surface	MT	Metric ton (1000 kilograms)
ESA	European Space Agency	NAE	National Academy of Engineering
		NAS	National Academy of Sciences
		NASA	National Aeronautics and Space Administration
		NRC	National Research Council
		OAST	Office of Aeronautics and Space Technology/NASA

OEP	Office of Energy Programs/NASA	SEPS	Solar electric propulsion system
RD&D	Research, development and demonstration	SPS	Satellite power system or solar power satellite
RDDT&E	Research, development, demonstration, test and evaluation	SSTO	Single stage to orbit
RF	Radio frequency	STS	Space transportation system
RFI	Radio frequency interference	UV	Ultraviolet radiation
SEB	Source evaluation board	VTO	Vertical takeoff
SED	Solar Energy Division/OEP	WMO	World Meteorological Organization

PICTURE IDENTIFICATION

Numbers refer to individuals numbered left to right from lower left corner. First numbers of each row are 1, 14, 26, 37, 49*, 54, 69, 84, 97, 108, 123 and 141. *Note that the fifth row (49) has only 5 persons.

- | | |
|-----------------------------|------------------------------|
| 1. William E. MacDaniel | 46. F. Carl Schwenk |
| 2. Klaus G. Schroeder | 47. John Oldson |
| 3. Peter E. Glaser | 48. Paul Kavanagh |
| 4. Samuel P. Altman | 49. Philip K. Chapam |
| 5. Sue B. Weir | 50. George A. Hazelrigg, Jr. |
| 6. Gerry M. Hanley | 51. T. A. Heppenheimer |
| 7. (Unidentified) | 52. Alain Dupas |
| 8. Janice Voss | 53. N. Douglas Pewitt |
| 9. William W. Wales, Jr. | 54. Hubert P. Davis |
| 10. Dick Fredericksen | 55. David Murphy |
| 11. J. Peter Vajk | 56. Woolsey Finnell, III |
| 12. Thomas C. Taylor | 57. William M. Jamieson |
| 13. Keith H. Miller | 58. Ray A. Williamson |
| 14. Rand E. Simberg | 59. Dale R. Corson |
| 15. Wayne F. Miller | 60. John M. Richardson |
| 16. Richard De Blasio | 61. Hugh E. Carmichael |
| 17. Ali B. Cambel | 62. L. E. Livingston |
| 18. Richard D. Wood | 63. Clarke Covington |
| 19. William V. McRae, Jr. | 64. Douglas S. Lilly |
| 20. Kevin K. Dybdal | 65. Gordon R. Woodcock |
| 21. Marvin D. Aasen | 66. Ronald Brownstein |
| 22. James H. Atkinson | 67. (Unidentified) |
| 23. Richard W. Earhart | 68. Alan R. Hildebrand |
| 24. David B. Cagle | 69. Ervin J. Nalos |
| 25. David L. Christensen | 70. Ralph H. Nansen |
| 26. Arel Lucas | 71. R. H. Dietz |
| 27. Harold E. Benson | 72. James Lazar |
| 28. Frederick A. Koomanoff | 73. David Phelps |
| 29. B. D. LaMar | 74. Paul O. Bernhardt |
| 30. A. R. Valentino | 75. Frederick J. Glatzel |
| 31. C. William Hamilton | 76. Jost Wischeropp |
| 32. Charles E. Bloomquist | 77. James E. Drummond |
| 33. Raefe M. Shelton | 78. Leonard W. David |
| 34. Ronald McCaffrey | 79. Lee Torrey |
| 35. Ziaul Hasan | 80. Sam Ankerbrandt |
| 36. Robert J. Giudici | 81. Stephen I. Shotland |
| 37. Marcia Smith | 82. David Higgins |
| 38. Charles H. Eldred | 83. (Unidentified) |
| 39. Eugene A. Carter | 84. Margaret R. White |
| 40. John M. Logsdon | 85. Dan McHugh |
| 41. Kirsten Oldenburg | 86. William C. Brown |
| 42. Sima Miluschewa Winkler | 87. Frederick H. Osborn, Jr. |
| 43. Patrick Q. Collins | 88. Tony Redding |
| 44. Robert Bramscher | 89. Ivor V. Franklin |
| 45. J. R. Williams | 90. James E. McCoy |

91. James R. Brownell
92. John R. Juroshek
93. Ernest L. Morrison
94. William B. Grant
95. Michael E. Samsa
96. Carl M. Langdon
97. John T. Lyman
98. John A. Hill
99. (Unidentified)
100. Vernon Pankonin
102. B. Ray Sperber
103. G. D. Arndt
104. (Unidentified)
105. Robert S. Block
106. Guo Kuan-Ling
107. Jan Beyea
108. Allan D. Kotin
109. (Unidentified)
110. Peter B. Boyce
111. (Unidentified)
112. John W. Freeman
113. Stefi Weisberg
114. William Wilson
115. Alan P. Daurio
116. Martin Abromavage
117. John J. English
118. (Unidentified)
119. Liz Clarke
120. John J. Daugherty
121. Carolyn M. Henson
122. H. Keith Henson
123. Sherry McNeal
124. Jerry E. Pournelle
125. H. Donald Calahan
126. Paul E. Brown
127. Michael R. Riches
128. James P. Naughton
129. D. Stuart Nachtwey
130. Dieter Kassing
131. Fred D. Rosi
132. Simon V. Manson
133. David B. S. Smith
134. Ross Alan Henderson
135. Raymond S. Leonard
136. C. H. Chan
137. Randall Clamons
138. Richard L. Olson
139. Markus Nowogrodzki
140. David G. Weir
141. (Unidentified)
142. Robert C. Ried
143. Robert H. Lewis
144. Heinz Stoewer
145. Klaus K. Reinhartz
146. Dr. Stephen Schmelling
147. Michael A. Leonard

FINAL PROCEEDINGS

DoE/NASA
SOLAR POWER SATELLITE PROGRAM REVIEW

Table of Contents

	<u>Page</u>
ACKNOWLEDGMENT.	i
INTRODUCTION.	ii
ACRONYMS.	iv
GROUP PICTURE	vi
PICTURE IDENTIFICATION.	vii
TABLE OF CONTENTS	ix
GENERAL SESSIONS:	
AN HISTORICAL PERSPECTIVE ON THE SOLAR POWER SATELLITE CONCEPT P. E. Glaser.	1
SPS AND THE OFFICE OF TECHNOLOGY ASSESSMENT R. A. Williamson.	8
OPENING REMARKS N. D. Pewitt.	9
OPENING REMARKS D. Beattie (represented by F. C. Schwenk)	10
INVOLVEMENT IN SPS:NSF B. Stein.	11
INVOLVEMENT IN SPS:NAS J. Richardson	12
SATELLITE POWER SYSTEM CONCEPT DEVELOPMENT AND EVALUATION PROGRAM THE ASSESSMENT PROCESS F. A. Koomanoff	15
<u>OVERVIEW SESSIONS:</u>	
OVERVIEW OF <u>SYSTEMS DEFINITION</u> ACTIVITIES FOR SATELLITE POWER SYSTEMS F. C. Schwenk	21

	Page
ENVIRONMENTAL ASSESSMENT OVERVIEW	
A. R. Valentin	36
SOCIETAL ASSESSMENT OVERVIEW	
C. E. Bloomquist	54
A COMPARATIVE ASSESSMENT OF THE REFERENCE SATELLITE POWER SYSTEM WITH SELECTED CURRENT, NEAR-TERM AND ADVANCED ENERGY TECHNOLOGIES	
M. R. Riches	66
AN OVERVIEW ON EUROPEAN SPS ACTIVITIES	
K. K. Reinhartz	78
SPS ISSUES: THE NEED TO LOOK AHEAD	
K. K. Dybdal	88
 <u>SYSTEMS DEFINITION:</u>	
SPS OVERVIEW: REQUIREMENTS, ALTERNATIVES, AND REFERENCE SYSTEM	
L. E. Livingston	91
EMERGING SPS CONCEPTS	
G. M. Hanley and G. R. Woodcock	95
INTEGRATION OF SPS WITH UTILITY SYSTEM NETWORKS	
B. M. Kaupang and R. W. Andryczyk	99
SPS COST METHODOLOGY AND SENSITIVITIES	
R. O. Piland	103
SPS TECHNICAL ISSUES	
C. H. Guttman	107
CRITICAL TECHNOLOGY AREAS OF AN SPS DEVELOPMENT AND THE APPLICABILITY OF EUROPEAN TECHNOLOGY	
D. Kassing and J. Ruth	109
 <u>ENVIRONMENTAL ASSESSMENT:</u>	
OVERVIEW OF ATMOSPHERIC EFFECTS	
D. M. Rote	113
IONOSPHERIC DISTURBANCE OVERVIEW	
C. M. Rush	116
ELECTROMAGNETIC COMPATIBILITY OVERVIEW	
K. C. Davis	120
NON-MICROWAVE HEALTH AND ECOLOGICAL EFFECTS: OVERVIEW	
M. R. White	122
SPS MICROWAVE HEALTH AND ECOLOGICAL EFFECTS - PROGRAM AREA OVERVIEW	
D. F. Cahill	124

SOCIETAL ASSESSMENT:

AN EVALUATION OF THE LAND AND MATERIAL REQUIREMENTS FOR THE
SATELLITE POWER SYSTEM

S. D. Ankerbrandt 125

SOCIETAL ASSESSMENT - INSTITUTIONAL ISSUES

S. I. Shotland 129

SOCIETAL ASSESSMENT - INTERNATIONAL ISSUES

A. P. Daurio 133

PUBLIC CONCERNS

S. R. McNeal 135

COMPARATIVE ASSESSMENT:

A METHODOLOGY FOR THE COMPARATIVE ASSESSMENT OF THE SPS AND
ALTERNATIVE TECHNOLOGIES

T. D. Wolsko 138

REFERENCE SYSTEM CHARACTERIZATION AND COST OVERVIEW

R. O. Piland 142

SPS AND ALTERNATIVE TECHNOLOGIES COST AND PERFORMANCE EVALUATIONS

M. E. Samsa 146

COMPARATIVE HEALTH AND SAFETY ASSESSMENT OF THE SPS AND ALTERNATIVE
ELECTRICAL GENERATION SYSTEMS

L. J. Habegger, J. R. Gasper, C. D. Brown. 150

ENVIRONMENTAL WELFARE COMPARISON

R. G. Whitfield. 154

RESOURCES/MACROECONOMIC/INSTITUTIONAL COMPARATIVE ASSESSMENT

R. G. Whitfield. 158

SUMMARY: SPS PROGRAM REVIEW

F. A. Koomanoff. 162

SUBSESSIONS:

- Systems Definition -

Structural Dynamics and Control Subsession
R. C. Ried, NASA/JSC, Session Chairman

SPS STRUCTURES AND CONTROL: A PERSPECTIVE

R. C. Ried 164

SPS ATTITUDE CONTROL AND STATIONKEEPING - REQUIREMENTS AND
TRADEOFFS

R. E. Oglevie. 168

SATELLITE POWER SYSTEMS STRUCTURES -- A 1980 TECHNOLOGY STATUS REVIEW
H. S. Greenberg. 172

DYNAMICS AND CONTROL OF THE SATELLITE POWER SYSTEM
S. J. Wang, J. N. Juang, G. Rodriguez. 176

A MODERN CONTROL APPROACH TO THE DESIGN OF THE SPS CONTROL SYSTEM
R. Gran. 180

ACTIVE CONTROL OF DEFLECTIONS IN SPACE STRUCTURES
J. Leavitt (paper not presented) 184

THE DESIGN OF LOW-COST STRUCTURES FOR EXTENSIVE GROUND ARRAYS
H. A. Franklin and R. S. Leonard 185

SPS STRUCTURAL DYNAMICS AND CONTROL WORKSHOP: FINDINGS AND RECOMMENDATIONS
R. C. Ried and D. L. Mingori. 189

Transportation Subsession
W. W. Wales, NASA/MSFC, Session Chairman

SPS PROGRAM REVIEW TRANSPORTATION PERSPECTIVE
W. W. Wales, Jr. 193

MINIMUM COST CRITERIA FOR SPS TRANSPORTATION TO GEO
D. E. Koelle 196

EARTH-TO-ORBIT TRANSPORTATION FOR SOLAR POWER SATELLITES
G. R. Woodcock and G. M. Hanley. 200

ORBIT-TO-ORBIT TRANSPORTATION
R. P. Bergeron 204

OFFSHORE SPACE CENTER (Offshore Launch Site)
D. G. Hervey 208

THE APPLICABILITY OF MPD THRUSTERS TO SATELLITE POWER SYSTEMS
R. M. Jones and L. K. Rudolph. 210

SATELLITE POWER SYSTEMS (SPS) SPACE TRANSPORTATION WORKSHOP SUMMARY
J. P. Layton 214

Open Forum Subsession
F. C. Schwenk, NASA/HQ, Session Chairman

TECHNOLOGY ALTERNATIVES FOR THE SPS
P. E. Glaser and P. K. Chapman 216

PROTOTYPE SOLAR POWER SATELLITE OPTIONS
B. R. Sperber and K. E. Drexler. 219

RECENT WORK ON USE OF LUNAR MATERIALS FOR SPS CONSTRUCTION G. K. O'Neill (presented by D. R. Criswell).	223
A CONTRIBUTION TO THE AVAILABILITY OF LUNAR RESOURCES FOR POWERSAT CONSTRUCTION T. A. Heppenheimer.	227
PASSIVE SOLAR REFLECTOR SATELLITE REVISITED C. Polk and J. C. Daly.	231
COMPARISON OF LOW EARTH ORBIT AND GEOSYNCHRONOUS EARTH ORBIT J. E. Drummond.	234
THE INFRARED ALTERNATIVE G. Andlauer (paper not presented).	237
SATELLITE POWER SYSTEM TOTAL PROOF-OF-CONCEPT PROGRAM W. V. McRae, Jr.	240
Power Conversion Subsession L. W. Brantley, NASA/MSEC, Session Chairman	
<u>POWER CONVERSION PERSPECTIVE</u> L. W. Brantley, Jr.	243
GALLIUM ARSENIDE (GaAs) POWER CONVERSION CONCEPT A. A. Nussberger	246
SPS SILICON REFERENCE SYSTEM G. R. Woodcock	250
PROTON DAMAGE ANNEALING KINETICS IN SILICON SOLAR CELLS W. E. Horne, I. Arimura, A. C. Day	254
A SURVEY OF THE MARKET, SUPPLY AND AVAILABILITY OF GALLIUM F. D. Rosi.	258
EVALUATION OF SOLAR CELL MATERIALS FOR A SOLAR POWER SATELLITE ¹ P. E. Glaser, D. W. Almgren, K. I. Csigi	263
SOLAR DRIVEN LASERS FOR POWER SATELLITE APPLICATIONS R. Taussig, P. Cassady, E. Klosterman.	267
CONCLUSIONS OF THE HUNTSVILLE SPS POWER CONVERSION WORKSHOP J. R. Williams.	271
Power Transmission I Subsession R. H. Dietz, NASA/JSC, Session Chairman	
<u>POWER TRANSMISSION AND RECEPTION - AN OVERVIEW AND PERSPECTIVE</u> R. H. Dietz.	273
MICROWAVE SYSTEM PERFORMANCE SUMMARY G. D. Arndt and E. J. Nalos.	277

SATELLITE POWER SYSTEM CONCEPT DEVELOPMENT AND EVALUATION PROGRAM CRITICAL SUPPORTING INVESTIGATIONS "SUMMARY"	
J. W. Seyl.	281
PHASE CONTROL SYSTEM CONCEPTS AND SIMULATIONS	
W. C. Lindsey	285
AN INTERFEROMETER-BASED PHASE CONTROL SYSTEM	
J. H. Ott and J. S. Rice	289
A POWER SATELLITE SONIC SIMULATOR	
J. H. Ott and J. S. Rice	293
SMALLER SPS SYSTEM SIZING TRADEOFFS	
G. D. Arndt and L. Monford.	297
<p>Construction and Operations Subsession H. E. Benson, NASA/JSC, Session Chairman</p>	
SPS CONSTRUCTION PERSPECTIVE/SUMMARY	
H. E. Benson.	301
INTEGRATED SPACE OPERATIONS OVERVIEW	
G. R. Woodcock.	303
SPECIFIC CONSTRUCTION TASKS	
W. V. McRae, Jr.	307
SPECIFIC SPS CONSTRUCTION STUDIES: CONSTRUCTION TASKS—CONSTRUCTION BASE	
R. W. McCaffrey.	310
CONSTRUCTION OF THE SPS PRIMARY STRUCTURE BY ANOTHER METHOD	
T. C. Taylor.	316
SPECIFIC SPS CONSTRUCTION STUDIES: OPERATIONS AND MAINTENANCE	
K. H. Miller.	319
SPS RECTENNA SYSTEM	
R. W. Andryczyk and B. M. Kaupang	323
AUTOMATED CONSTRUCTION OF LIGHTWEIGHT, SIMPLE, FIELD-ERECTED STRUCTURES	
R. S. Leonard	324
<p>Power Transmission II Subsession W. Finnell, NASA/MSFC, Session Chairman</p>	
RECTENNA SYSTEM DESIGN	
W. C. Brown, R. M. Dickinson, E. J. Nalos, J. H. Ott.	328
A THEORETICAL STUDY OF MICROWAVE BEAM ABSORPTION BY A RECTENNA	
J. H. Ott, J. S. Rice, D. C. Thorn.	332

	Page
POWER AMPLIFIERS (TUBE)	
W. C. Brown.	336
SOLID-STATE CONFIGURATIONS	
K. G. Schroeder.	340
SOLID STATE TECHNOLOGY	
D. G. Weir	344
MICROWAVE POWER TRANSMISSION WORKSHOP SUMMARY	
J. W. Freeman.	345
OFFSHORE RECTENNA FEASIBILITY	
J. W. Freeman, D. G. Hervey, P. E. Glaser.	348
HIGH-POWER MICROWAVE OPTICS FOR FLEXIBLE POWER TRANSMISSION SYSTEMS	
K. E. Drexler and B. R. Sperber.	352
SPS POWER TRANSMISSION - ARE MULTIPLE BEAMS A BETTER OPTION FOR EUROPE?	
R. A. Henderson and J. P. Stark.	356
<u>Power Distribution and Management Subsession</u> R. J. Giudici, NASA/MSFC, Session Chairman	
ELECTRIC POWER PROCESSING, DISTRIBUTION, MANAGEMENT AND ENERGY STORAGE	
R. J. Giudici.	359
HIGH VOLTAGE SYSTEMS (TUBE-TYPE MICROWAVE)/LOW VOLTAGE SYSTEM (SOLID-STATE MICROWAVE) POWER DISTRIBUTION	
A. A. Nussberger and G. R. Woodcock.	364
<u>SATELLITE POWER SYSTEM OPERATIONS</u>	
F. L. Pugh and A. I. Gordon	368
HIGH VOLTAGE SPACE PLASMA INTERACTIONS	
J. McCoy	372
SPS POWER MANAGEMENT WORKSHOP SUMMARY	
J. R. Williams	376
<u>Environmental Assessment -</u> Microwave Health and Ecological Effects Subsession D. F. Cahill, EPA, Session Chairman	
MICROWAVE HEALTH AND ECOLOGICAL EFFECTS OVERVIEW	
D. F. Cahill	378
STUDY OF THE BIOLOGICAL AND ECOLOGICAL EFFECTS OF SPS MICROWAVE POWER ON THE HONEY BEE	
N. E. Gary and B. B. Westerdahl.	379

SPS MICROWAVE EFFECTS ON AIRBORNE BIOTA STATUS REPORT S. P. Battista, E. J. Cook, T. H. Kunz, D. Hoyt, F. A. Wasserman, D. Byman, K. Youngstrom.	383
A REVIEW OF EFFECTS OF SPS-RELATED MICROWAVES ON REPRODUCTION AND TERATOLOGY E. Berman.	387
BIOLOGICAL EFFECTS OF CHRONIC PRE- AND POST-NATAL EXPOSURE OF SQUIRREL MONKEYS TO SPS FREQUENCY MICROWAVES J. N. Kaplan	392
PRELIMINARY PLANNING FOR FUTURE SPS MICROWAVE HEALTH AND ECOLOGY RESEARCH AND ASSESSMENT C. W. Hamilton	396
Ionospheric Disturbance Subsession C. M. Rush, DOC/NTIA/ITS, Session Chairman	
SIMULATED D- AND E-REGION EFFECTS OF THE SPS POWER BEAM R. L. Showen	400
MICROWAVE HEATING OF THE LOWER IONOSPHERE G. E. Meltz and W. L. Nighan	403
IONOSPHERE/MICROWAVE BEAM INTERACTIONS: ARECIBO EXPERIMENTAL RESULTS L. M. Duncan and W. E. Gordon.	407
SPS HEATING IN THE LOWER IONOSPHERE, AN EXPERIMENTAL VIEW F. T. Djuth, D. S. Coco, D. A. Fleisch, S. Ganguly	408
LABORATORY AND PROPOSED IONOSPHERIC EXPERIMENTS ON SPS MICROWAVE INSTABILITY P. Le-Cong, D. Phelps, J. Drummond, R. Lovberg, W. Thompson.	410
Electromagnetic Compatibility Subsession K. C. Davis, PNL, Session Chairman	
SUMMARY OF THE ELECTROMAGNETIC COMPATIBILITY EVALUATION OF THE PROPOSED SATELLITE POWER SYSTEM E. L. Morrison, Jr., W. B. Grant, K. C. Davis.	414
THE EFFECTS OF A SATELLITE POWER SYSTEM ON GROUND-BASED ASTRONOMY A. R. Thompson.	419
SPS EFFECTS ON OPTICAL ASTRONOMY G. J. Schuster.	423
THE EMC OF SATELLITE POWER SYSTEMS AND DoD C-E SYSTEMS J. H. Atkinson and M. D. Aasen.	424

	Page
ENCOUNTERS BETWEEN SPS POWER BEAMS AND SATELLITES IN LOWER ORBITS P. K. Chapman.	428
THE EMC IMPACT OF SPS OPERATIONS ON LOW EARTH ORBIT SATELLITES W. B. Grant, E. L. Morrison, Jr., K. C. Davis.	431
THE SPS INTERFERENCE PROBLEM — ELECTRONIC SYSTEM EFFECTS AND MITIGATION TECHNIQUES J. R. Juroshek	435
Atmospheric Effects I Subsession D. M. Rote, ANL, Session Chairman	
ATMOSPHERIC EFFECTS OVERVIEW D. M. Rote.	439
RECTENNA-RELATED ATMOSPHERIC EFFECTS J. Lee.	440
GROUND CLOUD AIR QUALITY EFFECTS K. L. Brubaker.	445
GROUND-CLOUD-RELATED WEATHER MODIFICATION EFFECTS J. Lee.	446
OVERVIEW OF HLLV EFFLUENTS IN STRATOSPHERE AND ABOVE K. L. Brubaker.	450
MESOSPHERIC CLOUD FORMATIONS J. M. Forbes.	452
D- AND E-REGION EFFECTS J. M. Forbes.	454
ENVIRONMENTAL EFFECTS OF SPS: THE MIDDLE ATMOSPHERE R. C. Whitten, W. J. Borucki, C. Park, H. T. Woodward, R. P. Turco, S. S. Prasad, L. A. Capone, C. A. Riegel.	458
Non-Microwave Health and Ecological Effects Subsession M. R. White, LBL, Session Chairman	
SUNLIGHT REFLECTIONS FROM A SOLAR POWER SATELLITE OR SOLARES MIRRORS SHOULD NOT HARM THE EYES M. T. Hyson	460
CHARACTERIZATION OF REFLECTED LIGHT FROM THE SPACE POWER SYSTEM H. B. Liemohn, D. L. Tingey, D. H. Holze, B. R. Sperber	464
PROTOTYPE ENVIRONMENTAL ASSESSMENT OF THE IMPACTS OF SITING AND CONSTRUCTION OF AN SPS GROUND RECEIVING STATION J. Hill	469

	Page
EFFECTS OF THE SPACE ENVIRONMENT ON THE HEALTH AND SAFETY OF SPACE WORKERS W. E. Hull.	473
HAZARDS TO SPACE WORKERS FROM IONIZING RADIATION IN THE SPS ENVIRONMENT J. T. Lyman	475
LATE BIOLOGICAL EFFECTS OF HEAVY CHARGED PARTICLES: CATARACTS, VASCULAR INJURY AND LIFE SHORTENING IN MICE E. J. Ainsworth, J. G. Jose, M. E. Barker, E. L. Alpen.	477
Atmospheric Effects II Subsession D. M. Rote, ANL, Session Chairman	
IONOSPHERIC OBSERVATIONS: ARCHIVED DATA AND THE HEAO-C LAUNCH M. Mendillo and C. C. Chacko.	480
THE LAGOPEDO EXPERIMENTS M. B. Pongratz, G. M. Smith, H. G. Horak, D. J. Simons, C. D. Sutherland, J. H. Wolcott, J. Zinn.	483
ICE FORMATION DURING LAGOPEDO UNO C. F. Lebeda and M. B. Pongratz	485
THEORETICAL INVESTIGATIONS OF IONOSPHERIC MODIFICATIONS PRODUCED BY ROCKET EXHAUST P. A. Bernhardt	487
EFFECTS OF ROCKET EXHAUST PRODUCTS IN THE THERMOSPHERE IONOSPHERE J. Zinn, C. D. Sutherland, S. N. Stone, L. M. Duncan, R. Behnke	489
PLASMASPHERIC AND MAGNETOSPHERIC EFFECTS OF POTV AND COTV EFFLUENTS Y. T. Chiu.	493
DISPOSITION OF SPS ELECTRIC THRUSTER EXHAUST D. H. Holze and H. B. Liemohn	496
EFFECTS OF ARGON ION INJECTIONS IN THE PLASMASPHERE S. A. Curtis and J. M. Grebowsky.	501
- Societal Assessment -	
International Considerations Subsession A. P. Daurio, PRC, Session Chairman	
MILITARY IMPLICATIONS OF SATELLITE POWER SYSTEMS J. P. Vajk.	506
SOME ASPECTS OF SPS ACCEPTABILITY IN EUROPE R. M. Shelton and I. V. Franklin.	508

	Page
STRATEGIES FOR MARSHALLING INTERNATIONAL SUPPORT FOR SOLAR POWER SYSTEMS	
D. G. Bailey and N. A. Irwin (paper not presented)	511
ALTERNATIVE INTERNATIONAL POLITICAL REACTIONS TO SPS	
J. R. Brownell, Jr. and M. J. Stoil	512
INTERNATIONALIZATION OF THE SPS: U. S. POLICY ISSUES, OPTIONS AND STRATEGIES	
S. Gorove (paper not presented)	514
Resources Subsession	
S. Ankerbrandt, PRC, Session Chairman	
SATELLITE POWER SYSTEM RECTENNA SITING STUDY	
W. A. Bavinger and J. B. Blackburn, Jr.	517
RELATIONSHIP OF ELIGIBLE AREAS TO PROJECTED ELECTRICAL DEMAND	
A. D. Kotin	521
PROTOTYPE SOCIETAL ASSESSMENT OF THE IMPACTS OF SITING AND CON- STRUCTION OF AN SPS GROUND RECEIVING STATION	
A. Bachrach	525
POTENTIAL FOR RECEPTION OF SPS MICROWAVE ENERGY AT OFFSHORE RECTENNAS IN WESTERN EUROPE	
P. Q. Collins	529
PRELIMINARY SPS MATERIALS ASSESSMENT	
R. R. Teeter and W. M. Jamieson	531
Public Concerns I Subsession	
S. R. McNeal, PRC, Session Chairman	
SOCIAL ACCEPTABILITY OF SATELLITE POWER SYSTEMS: A PRELIMINARY EXPLORATION	
S. Klineberg	534
ENERGY IMPLICATIONS OF AN AGING POPULATION	
A. B. Cambel and C. J. DeVita, G. A. Heffernan	536
CONCERNS OF THE CITIZENS' ENERGY PROJECT ABOUT THE S.P.S.	
K. Bossong	540
CONCERNS OF THE L-5 SOCIETY ABOUT SPS	
C. Henson, A. Harlan, J. C. Bennett	542
CONCERNS OF FASST ABOUT THE SATELLITE POWER SYSTEM	
A. D. Ladwig	544
A SOCIETAL ASSESSMENT OF STUDENT PARTICIPATION IN THE EVALUATION OF THE SATELLITE POWER SYSTEM CONCEPT	
R. D. Wood	548

Institutional Issues Subsession
S. I. Shotland, PRC, Session Chairman

A STUDY OF FEDERAL MICROWAVE STANDARDS L. W. David.	552
SATELLITE POWER SYSTEM: INITIAL INSURANCE EVALUATION W. Lloyd	555
PROBLEMS AND PROSPECTS FOR AN SPS ROLE IN NEW YORK STATE'S ENERGY FUTURE: A MAJOR CASE STUDY OF CONCEPT VIABILITY R. Sviedrys, D. McHugh, G. Homatas	556
SATELLITE POWER SYSTEMS (SPS): THE NEED FOR A DETAILED ASSESSMENT TO DEVELOP FEASIBLE MANAGEMENT SCHEMES M. S. Kaplan (paper not presented)	558
SOME JUDICIAL AND REGULATORY FACTORS S. L. Entres (paper not presented)	562

Public Concerns II Subsession
S. R. McNeal, PRC, Session Chairman

A DIFFERENT RACE R. S. Leonard.	564
ECONOMIC AND ENVIRONMENTAL IMPACTS OF SOLAR SATELLITE POWER SYSTEMS (SPS) E. Passerini	568
SOURCES AND NATURE OF RESISTANCE TO SATELLITE POWER SYSTEM (SPS) DEVELOPMENT W. E. MacDaniel.	570
SUN BUST, OR WHY SPS WILL NEVER GET OFF THE GROUND D. S. Pate.	572
PRESS PERCEPTIONS OF S.P.S. D. Dooling (paper not presented)	574

Institutional Issues II Subsession
S. I. Shotland, PRC, Session Chairman

THE INDUSTRIAL INFRASTRUCTURE FOR THE SOLAR POWER SATELLITE P. E. Glaser and P. K. Chapman	575
UTILITY SYSTEM IMPACTS OF THE SATELLITE POWER SYSTEM F. R. Goodman, Jr.	579
INSTITUTIONAL CONSIDERATIONS OF SPS/UTILITY INTEGRATION M. S. Crist.	581

	Page
AN ASSESSMENT OF SPS UTILITY INTEGRATION ISSUES ARISING FROM THE DISTRIBUTION OF ELIGIBLE RECTENNA SITES AND ELECTRICITY DEMAND CENTERS J. A. Hill and J. A. Rabe.	583
ELECTRIC UTILITY REQUIREMENTS AFFECTING SOLAR POWER SATELLITE DEVELOPMENT AND DEPLOYMENT K. R. Kubitz and R. H. Moss.	587
- Comparative Assessment -	
Contributed Papers Subsession M. R. Riches, DOE, Session Chairman	
THE POWER SATELLITE: TOWARD WHICH ENERGY CRISIS? T. A. Heppenheimer.	590
ECONOMIC POTENTIAL OF SPS O. E. Johnson.	594
SPS SALVAGE AND DISPOSAL ALTERNATIVES G. A. Hazelrigg, Jr.	598
THE SATELLITE POWER STATION AND NON-COST UNCERTAINTY ASPECTS OF RISK M. M. Hopkins.	600
SPS: THEIR FINANCING AND MACROECONOMIC EFFECTS R. S. Block.	603
Comparative Environmental and Societal Evaluations Subsession R. G. Whitfield, ANL, Session Chairman	
RESOURCE COMPARISONS (LAND, WATER, AND MATERIALS) W. B. Wilson.	607
MACROECONOMIC/SOCIOECONOMIC COMPARISONS OF SPS AND ALTERNATIVE ENERGY TECHNOLOGIES R. U. Ayres	610
ENVIRONMENTAL WELFARE EFFECTS EVALUATION W. B. Wilson.	612
CLIMATE AND ENERGY: A COMPARATIVE ASSESSMENT OF SPS AND ALTERNA- TIVE ENERGY TECHNOLOGIES D. A. Kellermeyer (paper not presented)	613
RESEARCH ON THE USE OF SOLAR ENERGY IN THE DEPARTMENT OF ENGINEER- ING THERMOPHYSICS, CHINA UNIVERSITY OF SCIENCE AND TECHNOLOGY K. L. Guo and X. S. Ge.	614

Cost and Performance I: Characterization and Audit
Subsession

M. E. Samsa, ANL, Session Chairman

SATELLITE POWER SYSTEM COST REVIEW R. E. Allen, P. E. Brown, E. J. Ziegler.	618
CRITICAL REVIEW OF SATELLITE POWER SYSTEMS (SPS) SPACE TRANSPORTATION COST ESTIMATES R. W. Earhart, C. W. Hamilton, K. Maher, R. R. Teeter.	622
UTILITIES VIEW OF SPS J. Patmore and J. Bohn.	625
ALTERNATIVE ADVANCED POWER GENERATION TECHNOLOGY CHARACTERIZA- TIONS M. E. Samsa.	627
<p>Cost and Performance II: Cost and Performance Evaluations Subsession M. E. Samsa, ANL, Session Chairman</p>	
ALTERNATIVE FUTURE ENERGY PRICE/DEMAND SCENARIO R. U. Ayres.	631
UNCERTAINTY IN ENERGY COST COMPARISONS J. K. Bragg.	635
AUTHORS INDEX.	640
GLOSSARY	658
ATTENDEES LIST	668

AN HISTORICAL PERSPECTIVE ON THE SOLAR POWER SATELLITE CONCEPT

Dr. Peter E. Glaser, Vice President

Arthur D. Little, Inc., Cambridge, Massachusetts

"It may be that, in the future, man will have no use for energy and be indifferent to stars except as spectacles, but if (and this seems more probable) energy is still needed, the stars cannot be allowed to continue in their old way, but will be turned into efficient heat engines." This statement of Bernal¹ rings even more true today, now that we have rediscovered the inexhaustible potential of solar energy.

A. SOLAR ENERGY DEVELOPMENT

The first time that solar energy was "discovered" was in the last half of the 19th Century in response to the energy needs of the industrial revolution. The efforts to harness solar energy which started, then accelerated through the beginning of the 20th Century, and then subsided with the successful development of energy economics based, at first, on coal and, subsequently, on the use of liquid petroleum fuels.

Again, even amid our seemingly plentiful energy resources in the mid-1950's, there was a resurgence of interest characterized by the symposia in Phoenix and in Tucson, and in 1961, the U.N. Conference on New Sources of Energy.

In 1962, Hubbert² indicated that the world's fossil fuel resources were finite, and that their availability would be only an ephemeral event--on the time scale of recent human history--of, perhaps, a few centuries. Subsequently, in 1965, Gaucher's projection³ of energy consumption in the United States indicated that soon after the year 2000, a gap would be created which could be filled by solar energy. During this period, there were growing concerns about the environment, about the role of nuclear power and, more recently, about the large-scale use of coal as a long-term replacement for liquid petroleum fuels. These concerns and uncertainties were further compounded by the limits-to-growth philosophy and its implications on the possibility, in the face of burgeoning populations and diminishing resources, of maintaining living standards. And finally in this setting, culminating in the dramatic events of October 1973, the potential of solar energy was rediscovered.

Now, there is a growing impatience to develop solar energy for widespread use, but despite optimistic expectations, the large-scale use of solar energy may take longer, be more difficult, and cost more than has been projected. What is clear is that no one energy source will meet all foreseeable future energy demands, that the search for new sources of nonrenewable fuels can only put off the day of their ultimate exhaustion and that there are major uncertainties in achieving the potential of known energy technologies. But, there is no need to rely on just one solution to the energy dilemma. The key to assuring future energy supplies will be the combination of apparently unlikely technologies and their applications in the most appropriate manner.

B. SPACE TECHNOLOGY SYNERGY

The launching of Sputnik on October 4, 1957, and the dramatic unmanned and manned space pioneering efforts marked the entry into the space age which irrevocably changed the evolutionary direction of planet Earth's civilization. The consciousness of the uniqueness of planet Earth, and the tangible demonstration that the tools of the space age promised an unlimited extension of new knowledge of the solar system had a most profound influence on advances in technology. These advances not only made it possible to develop satellites for Earth's observations and communications as well as for scientific purposes, but also significantly contributed to the development of electronics and computer technologies.

The synergism between space technology and efforts to harness solar energy could be used to overcome terrestrial obstacles to the conversion of solar energy such as inclement weather and the diurnal cycle. If satellites could be used for communications and for Earth observations, then it is also logical to consider satellites that could convert solar energy and place them in an orbit, e.g., geosynchronous orbit (GEO), where they could generate power for Earth continuously during most of the year. With a year-round conversion capability, such satellites could overcome not only the major obstacles to solar base-load power generation on Earth, i.e., means for energy storage and ineffective use of capital-intensive solar energy conversion devices, but to develop the technology for solar energy conversion in space on a scale which may not be possible on Earth because zero gravity and the absence of terrestrial influences no longer contain the size of a contiguous structure. The way to harness solar energy effectively would be to move the solar energy conversion devices off the surface of the Earth and place them in orbit away from the Earth's active environment where they would be continuously exposed to the sun. The most favorable orbit for solar energy conversion would, of course, be around the sun, but GEO is a reasonable compromise at this stage of space technology development because solar energy in GEO is available for 24 hours a day during most of the year.

The "one small step for a man, one giant leap for mankind" taken in July, 1969, set the stage for what still is the nearly imperceptible movement of humanity beyond the Earth's surface. It is in this context that the SPS represents one of the significant steps which could utilize the immense resources within the solar system and beyond in the continuing quest to expand the evolutionary niche of the human species.

C. SPS CONCEPT AND OBJECTIVES

The solar power satellite concept (SPS) challenged the view prevalent in the 1960's that solar energy conversion methods could not make a significant contribution to energy economies, and demonstrated that there are no *a priori* limits on the development of energy resources in space. The SPS concept although not a panacea for increasingly complex energy supply, environmental and societal problems could open up a new evolutionary direction to influence the future course of energy resource and human development. As originally conceived⁴, the SPS would convert solar energy into electricity and feed it into microwave generators forming part of a planar, phased-array transmitting antenna. The antenna would precisely direct a microwave beam of very low power density to one or more receiving antennas at desired locations on Earth. (An SPS system would include a number of large satellites in GEO orbit, each beaming power to one or more

receiving antennas.) At the receiving antenna, the microwave energy would be reconverted to electrical energy and then fed into an electrical utility transmission system.

At the outset, the following objectives were proposed for the development of the SPS concept:

- To be of global benefit;
- To conserve scarce resources;
- To be economically competitive with alternative power-generation methods;
- To be environmentally benign; and
- To be acceptable to the nations of the world.

D. EVOLUTION OF SPS REFERENCE SYSTEM

Preliminary studies of the SPS concept were performed at Arthur D. Little, Inc., from 1968 to 1972. During this time, the SPS concept was discussed at scientific and professional society meetings, and presentations were made to NASA and the President's Science Advisory Committee. In 1972, the NSF/NASA Solar Energy Panel outlined a program plan for the SPS R&D program and suggested funding levels.⁵ In 1972, Arthur D. Little, Inc., joined with Grumman Aerospace, Raytheon Company and Spectrolab Division of Textron, to evaluate the feasibility of the SPS concept on behalf of NASA.⁶ In this feasibility study, a base-line design was adopted to provide a power output of 5 GW on Earth. In addition to structural design and control, RFI avoidance techniques were investigated and key technological, environmental, and economic issues were identified.

The results of this study encouraged NASA's Johnson Space Center and Marshall Space Flight Center to start extensive system definition studies with the help of Boeing Aerospace⁷ and Rockwell International.⁸ In 1976 the Energy Research and Development Administration was assigned responsibility for the SPS program. A task group was formed; it recommended that the SPS concept be evaluated and outlined a program for this purpose.⁹ In 1977 the Department of Energy and NASA approved the SPS Concept Development and Evaluation Program Plan,¹⁰ with the objective: "to develop by the end of 1980 an initial understanding of the technical feasibility, economical practicality, and the societal and environmental acceptability of the SPS concept." (The results of the DOE/NASA SPS program are discussed in detail at this Review meeting.)

E. SPS PROGRAM ISSUES

The SPS program is unique in that, for the first time, a major technology program focuses not just on key technology issues but is concerned with the evaluation of environmental effects, comparative economic factors, and societal issues so as to identify program risks and uncertainties before committing to the next phase of a development program. This focus for the SPS program is appropriate at a time when public scepticism of complex, large-scale technologies has been justified by well-publicized failures (e.g., the Three Mile Island incident) and distrust of assurances by either industry or government that technological systems will not contribute to involuntary exposure to health and safety hazards.

The views and opinions expressed by those in support of, and in opposition to, the SPS concept represent widely different philosophies and ideological beliefs. The contributions of distributed and centralized technologies, accountability of industry and government, participatory democracy, the price and availability of nonrenewable fuels, the environmental and health impacts of alternative energy technologies, and the degree of international cooperation in the development of the SPS will influence the future course of the SPS program.

The SPS appears to involve technologies which are at opposite ends of the scale of distributed terrestrial solar technologies. But the differentiation of solar technologies according to the scales of their conversion and distribution systems introduces artificial barriers which may hinder rather than advance the development of the most appropriate solar technologies to meet end-use requirements.

Whether energy conversion and distribution should be centralized or dispersed will be determined by the energy intensiveness of the end-use, and a broad range of other factors. There is no obvious difference in the potential benefits of distributed and centralized solar technologies provided that economic, environmental, and societal criteria are met. Perceptions of these technologies by individuals, communities, regions, and countries will differ at various stages of technology development. Preconceptions regarding the most appropriate solar technologies, based on political or ideological considerations, or alternative value systems for applications in industrialized or developing countries, may compromise the application of the most effective solar technologies to meet specific end uses. Assuming that there will always be energy-intensive regions where the solar insolation availability is less than the energy required for specific end uses, there will be continued requirements for utility-provided electrical power.

There are concerns that an SPS program effort will reduce the funds available for the development of terrestrial solar applications. This certainly is not the case now (fiscal 1980, \$800 million is allocated to the terrestrial solar programs and \$6 million for the SPS program), or even under the planned SPS ground-based exploratory program. The longer-term SPS development program will be strongly influenced by the results of the ground-based exploratory development program, by the assessments of economic, environmental and societal issues, and the level of international participation. To control the overall risk, the SPS program should be time-phased, with the "economic" purpose of each program phase being to obtain information that will permit deliberate decisions to be made whether to continue the program or to terminate it.

The SPS integrates many different generic technologies ranging from solar cells to electric propulsion which are being developed to meet a wide variety of terrestrial and space program objectives. The SPS is a sufficiently complex system so that new technologies which, based on past experience, are very likely to be developed, will further enhance the overall SPS feasibility. For example, in the 1930's, jet propulsion or rocket propulsion were not considered a serious competitor to the internal combustion engine and the propeller of an airplane. Twenty years later, the commercial jet airplane was shrinking global travel time and distance and the era of space exploration was about to change the course of human history.

In spite of technological optimism, there are significant environmental issues which have to be resolved before a deliberate SPS development program can be undertaken. The most significant environmental issue is the effect of the long-term exposure to low-level microwaves.

There are predictable problems with the land use associated with receiving antennas. To some extent, the public attitudes towards receiving antenna locations will depend on locally perceived costs and benefits, for example, secondary uses of the antenna site for agricultural purposes. Therefore, offshore antenna designs deserve much more attention and secondary uses for mariculture, wave energy extraction, and location of port and industrial facilities should be evaluated.

The effects of space transportation system rocket-exhaust products on the Earth's upper atmosphere will have to be quantified and experimental data gathered so that mitigating strategies can be considered, such as trajectory control or, after the SPS has been shown to be an effective method for providing power to Earth, the eventual use of extraterrestrial materials.

The economic justification for proceeding with an SPS development program should be based on a classical risk/decision analysis which acknowledges that it is not possible to know the cost of a technology which will not be fully developed for at least 10 years and commercialized, i.e., produced, operated and maintained, in not less than 20 years. Such justification, of course, is equally difficult to provide for other advanced energy technology projects. This justification, therefore, requires an appreciation of the competitive cost of alternative energy sources for the generation of electrical power which would be available in the same period.

For the SPS reference system which utilizes demonstratable technology, the cost estimates, rough as they are and subjected to criticism as they may be, fall within a potentially interesting range--clearly sufficient to justify a continued research and technology verification program. Projections of SPS construction and operational costs between the years 2000 and 2030 are speculative. Forecasts of future costs presume a knowledge of future technology which, when contrasted with revolutionary advances of technology during the past few decades, makes such a projection of doubtful validity. Even though cost projections may imply a trillion dollar capital investment in a system consisting of 60-5 GW SPS constructed over a 30-year period, it should be acknowledged that introduction of any alternative advanced energy technology on a similar scale will require comparable levels of investment. For example, the capital investment in terrestrial solar energy conversion technologies to produce heat and generate electricity to meet 20% of United States' energy requirements is projected to reach one trillion dollars by the year 2000.¹¹

F. GLOBAL IMPLICATIONS AND POTENTIAL

One of the most significant aspects of the SPS concept is its global implication. Once the feasibility of the SPS concept has been established, other countries may be interested in joining in the development and demonstration phases of the SPS program, and in space experiments which will need to be conducted on future space missions. International participation in the SPS program would permit the sharing of the significant development cost of the SPS by the countries which could also be expected to benefit from the power which would be

available to them. International participation would also ease the obtaining of international agreements, including frequency assignments in synchronous orbit positions, and provide assurance of the peaceful nature of the SPS, the adherence to environmental standards, and the availability of generated power on a global scale. Furthermore, international involvement in the SPS development program should assure that the SPS will not be controlled by any one industrial organization, sector of industry, or even one country.

To derive the maximum benefits from a global SPS system, policies will have to be adopted which will be acceptable to other countries and lead to the formation of the most appropriate international SPS organization. The international organizational structure should be developed to contain, channel, and control the SPS technologies while they are being developed so that the societal issues could be addressed in parallel with the technology and not be spliced in later. As the effects of SPS technologies will extend past national frontiers, decisions regarding their development should not be left exclusively to national jurisdiction but made part of "transnational affairs."

The benefits of the SPS should be available on a global basis and increase the opportunities for developing countries to take an active part in the utilization of energy sources available beyond the biosphere. To arrive at a "planetary bargain"^{1,2} will require that the SPS concept advance the interests of all nations, and a political consensus be formed through widespread realization that humanity is in a dangerous passage together on a world of finite resources, ultimate weapons, and unmet requirements. The SPS may require that new means be developed to manage pluralism from a global perspective. Broad initiatives and declarations of principle will require some sense of participation by all who will be affected by the operation of the SPS. But the SPS may be developed and eventually managed by those countries which have the most concern with energy supplies, the best technical capabilities, and the required capital resources. What will be required is to establish a consensus regarding the future course of SPS development. To achieve a consensus, a body such as the U.N. Committee for Peaceful Uses of Outer Space may keep the SPS program under review--not to tell individual nations what to do, but to tell the collectivity of nations what they had better bargain collectively about doing together.

The SPS concept, therefore, could provide not only an impetus for peaceful cooperation among nations, but help humanity face the challenges posed by the inevitable transition to renewable sources of energy. It may be a step to allowing human imagination to utilize the potential of space and its rich resources for improving the human condition and point towards a new direction for the evolution of the human species.

¹J. D. Bernal, The World, the Flesh and the Devil, Indiana University Press, Bloomington, Indiana, 1964.

²M. K. Hubbert, "Energy Resource," Nat. Acad. Sci. Pub. No. 1000: 91, Washington, D. C., 1962.

³L. P. Gaucher, "Energy Sources of the Future for the United States," Solar Energy, Vol. 9, p. 119, 1965.

⁴P. E. Glaser, "Power from the Sun: Its Future," Science, Vol. 162, p. 857.

⁵National Science Foundation, "An Assessment of Solar Energy as a National Resource," NSF/NASA Solar Energy Panel, University of Maryland, College Park, Md., December 1972.

⁶P. E. Glaser, O. E. Maynard, J. Mockovciak, Jr., and E. L. Ralph, "Feasibility Study of a Satellite Solar Power Station," NASA CR-2357, NTIS N74-17784, 1974.

⁷Boeing Aerospace Co., "Solar Power Satellite System Definition Study," Vol. I-VII, NASA, Houston, Texas, NAS9-15636, April 1979.

⁸Rockwell International, "Satellite Power System Concept Definition Study," NASA, HUNTSVILLE, ALA., NAS8-32475, April 1978.

⁹Energy Research and Development Agency, Task Group on Satellite Power Stations, ERDA-76/148, 1976.

¹⁰U. S. Dept. of Energy, "Satellite Power System Concept Development and Evaluation Program Plan, July 1977-August 1980," DOE/ET-0034, NASA and U. S. Dept. of Energy.

¹¹C. A. Zraket and M. M. Scholl, "Solar Energy Systems and Resources," Int. Sci. Forum on Energy for Developed and Developing Countries, Nice, France, October 1979, The Mitre Corp., McLean, Virginia.

¹²H. Cleveland, "Do Global Technologies Require Global Politics?" Technology in Society, Pergamon Press, New York, Vol. 1, No. 1, Spring 1979, p. 19.

SPS AND THE OFFICE OF TECHNOLOGY ASSESSMENT

Ray A. Williamson

Energy Group, Office of Technology Assessment, Washington, D. C. 20510

In August 1978, the Committee on Science and Technology of the U.S. House of Representatives requested OTA to study the SPS as a long-term energy option. Specifically, it asked that SPS be assessed with respect to other potential energy sources, and that the technological, economic, and environmental barriers to implementation of the SPS be identified and investigated. In keeping with this mandate, the OTA assessment is being conducted in its Energy Group. The study will result in a broad and independent assessment of the potential advantages, shortcomings and impacts of satellite power systems which will aid Congress in its deliberations about these systems. As such it will provide a background against which to evaluate analytical results and program proposals arising out of the DOE/NASA assessment.

As a support agency of the U.S. Congress, OTA's mandate is to make independent, broadly based technical assessments which are requested by Congressional committees. The Office examines technology development and its consequences using a broad range of analysis from both internal and external sources. It does not make recommendations about particular courses of action to Congress but does analyze alternative policy directions. The preparation of the final report from each study is guided by the advice of an Advisory Panel composed to mean and women of various viewpoints.

The OTA SPS assessment is divided into four categories -- Technical Options, Public Acceptance, Institutional Acceptance, and Programmatic context. Each category is the subject of a workshop of experts brought together by the OTA project staff. Prior to each workshop, a working paper on each category is prepared which serves as background and a starting point for each workshop. The task of the workshops is to extend and expand the scope of the working papers and to develop the key issues concerning the future of the SPS. OTA staff will incorporate the working papers and the findings of each workshop into its final report to Congress.

The study is scheduled for completion by September 1980.

OPENING REMARKS

N. D. Pewitt

Deputy Director, Office of Energy Research, U. S. Department of Energy

The Department of Energy through its predecessor, the Energy Research and Development Administration (ERDA), became involved in the assessment of the SPS concept in 1976. The Office of Management and Budget assigned the responsibility for the assessment to ERDA to insure that the SPS would be evaluated as an energy option. ERDA established a task group to study SPS and to recommend a course of action. This group recommended a detailed assessment of SPS covering technical feasibility, economic viability, environmental and societal acceptability, and the merits of SPS when compared with other future alternatives. The scope and size of the recommended effort was unprecedented in the history of assessing energy options. Furthermore, it was recommended that the assessment be done before the country became committed to a costly development program on the basis of insufficient or inaccurate knowledge. The three-year, \$20-million assessment will be completed, as planned, by the middle of this year. I believe that the agenda of this meeting attests to the scope and level of effort that has been put into the assessment.

While DoE is managing the SPS assessment, I have no illusions that we could do the job without the support of expert groups in various agencies, universities, and in industry all around the country. The National Aeronautics and Space Administration and its field centers and contractors provided outstanding support at the outset in getting the ERDA task group up to speed, in developing the reference system, and performing the necessary supporting technology studies. The EPA assumed a critical role in the microwave health and ecology area. The Institute for Telecommunication Sciences of the Department of Commerce assumed the key role in assessing the impacts of the microwave beam on radio frequency communications systems and on other electronic systems. The DoE national laboratories, namely, Lawrence Berkeley Laboratories, Argonne National Laboratory, Los Alamos Scientific Laboratories, and the Pacific Northwest Laboratories, all contributed their skills. The Planning Research Corporation performed a broad range of studies in the societal area. A total of some 60 groups, ranging from large industrial firms to small consulting groups, have been involved.

I believe the SPS assessment will help to establish a pattern for future assessments of major technological proposals. Of particular value is the recognition of the vital, legitimate and undeniable role of the public in participating in the decision process. The assessment has made a pioneering effort in this direction, which could serve well as a model for others.

OPENING REMARKS
F. C. Schwenk (representing Donald Beattie)
NASA Headquarters

It is my privilege to represent the National Aeronautics and Space Administration at this significant meeting on satellite power systems and to welcome all of you to this program review and symposium. NASA under Don Beattie has established some strong working relationships with the Department of Energy in a number of critical areas of energy technology. We in NASA are pleased to be involved also with the Department of Energy in the assessment of SPS, an important source of energy for the future. As mentioned by Doug Pewitt, we in NASA realize also that all the source of wisdom does not lie on the banks of the Potomac; we believe it resides in our NASA centers. But that was before I joined the SPS program; I realize now that there is much wisdom throughout this great land of ours. You, the participants in this assessment process and interested contributors, are commended for your role in this comprehensive study of a potentially major energy alternative. Your work is a key factor in determining how SPS will be judged in the coming months. Obviously its not the only factor, but certainly a key factor. We are also setting a standard for evaluation of advanced technologies. Under the leadership of Fred Koomanoff, which Doug Pewitt so well recognized, we are creating a knowledge base for making decisions the likes of which few, if any, leaders have ever had. While I have observed the growth and interest and effort on SPS since the beginning -- I count Peter [Glaser] as one of my longtime associates and friends -- I've had only 10 months of official association with this program. During this time it has been my privilege to learn to know many in this outstanding group assembled here. Please accept my sincere thanks on behalf of NASA and personally for your support and professional dedication.

INVOLVEMENT IN SPS
Bernard Stein
National Science Foundation

The National Science Foundation became involved in the SPS Assessment through the Congressional Authorization Act for fiscal 1979. One of the provisions of that act stated that the Director of the National Science Foundation, in consultation with public and private individuals and organizations is authorized to determine the need to provide support for a study of the feasibility of transmitting solar energy to earth by using orbital structures manufactured from lunar or asteroidal materials. An affirmative determination led the Director of NSF to initiate discussions with DOE and NAS expanding the framework of contacts which had been previously initiated by DOE with NAS in an attempt to enlist the Academy's capabilities in the SPS assessment effort. The subsequent tripartite discussions resulted in an agreement by the Academy to participate as an independent reviewer of the SPS concept through its National Research Council Environmental Studies Board. This Board submitted a study proposal to NSF which, as accepted, contained six main elements: (1) a review of studies in environmental, technical, socioeconomic and international aspects of the concept of satellite power systems; (2) a comparison of the satellite power systems with other energy sources and associated conversion processes; (3) the identification of critical scientific and technical issues in evaluation of the SPS concept; (4) the identification of omissions in the DOE SPS assessment; (5) provision of a critique of final results of the DOE assessment, and (6) the examination of the feasibility of using lunar and asteroidal materials in the construction of orbiting structures.

Approval of the proposal led to a two year contract between the Academy and NSF commencing 1 July 1979. While NSF remains the sole executive agent in the exercise of authority derived from the provisions of the contract, funds are provided by both NSF and DOE; both agencies receive interim reports and will receive a final report on the Academy's study.

Beyond NSF's role in the process of energy policy formulation the Academy study points up another issue -- mainly the user benefits in connection with other NSF activities. The identification of potentially promising scientific and technological initiatives can be expected to indicate areas of opportunity in the fields of basic research. Translated into research proposals, there is good reason to believe that NSF would be counted among those federal agencies that will provide support for the execution of the more interesting of the proposed efforts. NSF will, of course, be especially concerned by the impact which the implementation or even testing of the SPS concept would make on existing areas of scientific research. Here we can immediately think of radio astronomy but there are others as well. Another, and perhaps somewhat less pressing but no less important consideration, is the assessment of the impacts of SPS on the society and the environment. Here NSF feels the Academy study is an experiment in the study of consequences of technological efforts that may have some relevance to many scientific research activities.

This is a brief legislative and administrative history of how the National Science Foundation came to SPS and how NSF might benefit from the considerable effort which the Academy is making to the exploration of future energy choices. Dr. John Richardson, the principal Academy staff official responsible for the SPS study, will describe how the Academy and National Research Council has organized the study and speak of activities that have been or soon will be started.

INVOLVEMENT IN SPS
John Richardson
National Academy of Science

To amplify what you have just heard concerning the NAS reasons for participating in the assessment of the SPS concept: the ultimate commitment of effort and resources on this program is truly staggering and, by the same token, even the next step of investigation will mean a considerable expenditure of public funds. The Academy believes that it should, along with many others, speak to what, if anything, should be done next in the R&D. It has been shown that the assessment of SPS technology may contain many lessons about the assessments of other large scale technologies that our country will be called upon to make in the future. The Academy report will be completed in June of 1981, hopefully in time for use in connection with the DOE submission to OMB for the fiscal 1983 budget in September 1981. I would also like to pay tribute to the responsiveness and excellence both in DOE and NASA and in other groups in providing information to the Academy during the beginning phases of its investigation.

Turning to the substance of some of our impressions, I can't give you any conclusions but I can tell you some of the striking features of SPS that are occurring to us and certainly have occurred to others. The tremendous extrapolation of scale from our present capabilities permeates the concept. Example: the Heavy Lift Launch Vehicle and the Electric Orbit Transfer Vehicle contain extrapolations in space transportation systems both in physical performance and in cost to a huge extent, in particular, I believe that no ion-engine flight from LEO to GEO has yet occurred and we are extrapolating that. The solar cell technology has to be extrapolated from current achievements of square centimeters of area to the integration of square kilometers of solar cells, a factor of ten to the tenth, and at the same time this has to be scaled down by a factor of one hundred in cost. In terms of the population of space workers, the world has seen perhaps fifty astronauts operating in orbit but the space worker population of the SPS would be many tens of thousands. The reliability of the parts and the subsystems has to be high; while we might not have to achieve the ideal reliability of a computer system where a complete shut-down is preferable to even a small impairment, we do want something like the reliability of our telephone system in which minor impairments are preferable to a complete shut-down. Although it is not a feature of the SPS reference system, some have proposed and the NSF is bound to investigate through our work, the eventual space manufacture of SPS components and, in part, the manufacture of these components from non-terrestrial materials -- also an extrapolation of capacity and capability.

Turning to the economic area, in the absence of any fatal flaw to this system -- perhaps a good rule might be that if the SPS costs are found to be high and firm then it should be scrubbed, but if the costs are high and soft then we should do some R&D. As of now I think the costs are high and not firm. The R&D for this project must extend over long periods of time and will come to huge amounts of money; one estimate is that by the time the first SPS is built some \$68 billion will have been spent over a period of some 16 years. The financing of such amounts on such a time scale is not in the usual horizon of Wall Street and that will be a difficulty to overcome. Some members of our group reason that the unit costs of an SPS will certainly vary somewhat with its economic lifetime. The reference system has a lifetime assumption of 30 years but as far as we can see that lifetime is not uniquely set by any estimates of wear and tear on the system or by any estimates of technological change. It seems that the factors that set the economic lifetime of SPS need to be more sharply determined and the sensi-

tivity of SPS unit costs to assumed lifetime should be studied. Further, uncertainty of the SPS energy ratio estimates make comparison with other technologies unclear as to the advantages of SPS: the question of energy ratio is clearly an area for important further analysis.

Turning to the environmental effects of SPS, the protection of the large population of space workers from ionizing radiation is a matter of quite a different degree from what we have been able to accept with the astronauts. There is a much greater worker population and the occupational exposure limits are much lower than they are for the astronauts. As for the microwave health issue, one can easily think of an ideal resolution of that: first, one needs clear cut research results on the nature and the severity of the microwave long-term health effects. Those populations which are at risk could be identified and a quantitative assessment of what risks would be incurred at various exposure levels could be made; a quantitative assessment of the impact on SPS design and operation of various control measures could be made and then full information should be provided to the public so they can understand this problem. Clear cut research results and quantitative risk assessment for low level long-term exposures are not likely to occur in the next five years simply because it takes that long or longer to derive those results. The SPS program is going to have to operate in an atmosphere of great uncertainty in this area. Allocation of spectrum and orbit will be severely competitive; this will have to be recognized early and planned. Communication's use of the orbit and the frequency is increasing and in 30 years there will be a lot of vested interests to consider.

Turning to the social areas, one can see several motives other than economic favoring an SPS system. There surely will accrue an advantage to society from a renewable energy source with promise of long-term stability, quite apart from simple economic benefit. It is also possible that SPS may be more benign in an environmental sense than other large scale energy generating technologies. An SPS system suitable redesigned on an international scale could offer benefits there as well as domestic benefits. An important question that the reference system does not address is how much more can the SPS be expanded; is the limit of its supply 300 gigawatts or can we go to 600 or 3,000 gigawatts? That's rather important for the international benefit question. The degree of international cooperation and participation will depend on further political exploration of this question.

We think the next step of those associated with SPS is to give guidance to the government on planning and on its next investment in R&D. Therefore, it is clear that the SPS has to be assessed in comparison with other electrical energy technologies; but which ones? Clearly those that are competing for public R&D funds. In the period under consideration for SPS it is viewed not as a substitute for conventional energy sources, but as a supplement to coal and fission, at least early on. So comparison with coal does not advise you whether you should stop coal and build SPS, but it will provide an important benchmark that ought to be measured. The merits of SPS also need to be considered relative to new technologies that might supplement our conventional technologies and these have been mentioned before; they are ground-based photovoltaics with storage capacity, liquid metal fast breeder, nuclear fusion. These technologies are presently competing for federal R&D funds.

Recognizing a few of those involved in the Academy study: the chairman of the committee is Dale Corson, President Emeritus of Cornell University. John Dougherty of Electric Power Research Institute is one of the participants of the committee concentrating on the technological aspects. Thomas Payne, former NASA administrator now at Northrop; Kumar Patel of Bell Laboratories; Marvin Chodorow of Stanford University and Ross McDonald, now of the University of North Carolina, are a few of the others involved in this area. Turning to the economic aspects, the members of the committee studying this area are Charles Hitch, former president of the University of California; Klaus Heiss, president of ECON, Inc.; and Bruce Hannon of the University of Illinois. Leading various efforts on the environmental aspects are Richard Setlow of Brookhaven; William Gordon, Dean of Natural Sciences at Rice University and Gordon Little of NOAA. The work on the international aspects and public acceptance aspects is being led by former Ambassador Leonard Meeker and Norman Bradburn, Director of the Public Opinion Research Center at the University of Chicago, respectively. Donald Hornig now at the Harvard School of Public Health, formerly Science Advisor to Presidents Kennedy and Johnson is organizing and directing the comparative assessment. As stated, it is not appropriate for me to draw any conclusions at this early stage but I do want to make a few personal observations. The DOE assessment is truly unique in its early timing and its thoroughness, and it has been adequately observed earlier that it will be a useful model in the future. I have found that the 20- to 50-year time frame of the concept makes it subject to a very large discount rate, both in money and in the time that people are willing to allocate to it now -- a handicap that SPS has to overcome. Some characteristics of the SPS concept are the following: its supposed to make a massive investment in a single piece of equipment; to design this for a very long economic lifetime of 30 years; to put it in an inaccessible place; and to use technology that is galloping along in its development. Under these conditions flexibility has to be designed in along with the ability to retrofit the system, otherwise we will be amortizing technically obsolete hardware. As we come closer to any actual deployment decision for SPS its going to be useful to examine the ripple effect on the entire economy of investing \$30 billion every year for three years on one segment of one industry. A macroeconomic assessment needs to be done, not this year, but a little closer to actual deployment. Finally, what strikes me is that the real SPS decisions are going to be made in a new decade by people other than thee and me; the younger generation will be the inheritors of the SPS and so their attitudes are all-important.

In closing, since starting on this project, one literary allusion comes to mind that might apply to our attitude toward this study: "Make no little plans, they have not the power to move men's minds."

SATELLITE POWER SYSTEM
CONCEPT DEVELOPMENT AND EVALUATION PROGRAM
THE ASSESSMENT PROCESS

by

Frederick A. Koomanoff

Director, Solar Power System Project Division
Department of Energy

Our energy future rests with our actions...

...We may learn from history and try to avoid repeating its errors.

...We may guide our thinking and actions based on predictions and forecasts and hopefully prevent today's errors from becoming history.

...Or, we may combine our knowledge from the past with our images of the future and create a present. A present resounding with sensitivity to today's needs but always allowing for modification as those needs change.

Such thinking should direct our policies toward new technologies away from either technological timidity (as exemplified by our lack of enthusiastic support for Dr. Goddard's genius in rocket propulsion, or the rejection of the gas turbine aircraft engine by both the British and American Academies of Science in the 1930's) or technological megalomania (depicted by the nuclear aircraft)

History, in my judgment has shown the errors of following either of these paths. History, more significantly, has shown convincingly the need and value of energy in reducing toil, increasing food production and bringing the world closer together by transportation and communication systems.

Today, predictions of world population for the next twenty years show a growth from about four billion people to six and one-half billion people by the year 2000 (see Fig. 1). India alone will add in excess of 200,000,000 people in the next twenty years, approximately the present population of the United States of America. This growth is largely immutable, being rooted in rate of reproduction of the present world population. It may be controlled by the unfortunate circumstances of war, pestilence or famine. Or, its consequences may be ameliorated at least in part by the availability of energy, preferably based on renewable systems. Systems that may be technically and economically viable, environmentally and socially acceptable; and that will not deplete the earth's resources.

The need for increasing the world's energy supply to support a continuously increasing world population with natural aspirations for a better way of life is now apparent to most thoughtful people. Accordingly, technological options which have promise of making significant contributions to the energy requirements of the world must be seriously and aggressively assessed. In a mature society, new technologies should meet four conditions for acceptance:

The first, of course, is technical possibility. This assures that the research and development base from which this conclusion is reached is sufficiently solid to establish the level of risk involved in moving forward toward technological development.

The second condition is that of economic viability. The ability to provide a return on investment to the stake holders, whether they be owners of private corporations or the public in general.

The third condition is environmental acceptability as perceived by widely diverse constituent groups.

The fourth condition is social acceptability which includes public attitudes, national and international agreements and participation.

The underlying philosophical approach to the SPS Concept Development and Evaluation Program and its assessment process has evolved from these four necessary and sufficient conditions of the technology equation.

The evolving image of technology reflecting the maturity of an industrial society, may be understood again by learning from history. The evolution over the past 100 years or so of the forces involved in producing a successful technology shows an increase in the number of forces (i.e., groups) that come into play as a technology moves from the idea stage to successful implementation.

A hundred years or so ago only two forces were involved in the culmination of a successful technology: Producers who were motivated by potential profits, and Users, sensing benefits. With these two forces operative, a technology could become successful. Approximately fifty years ago, Governments at the federal, state and local levels, recognizing the value of technology, became involved through direct and indirect subsidies to both the Producers and Users. Today, an additional force has emerged. I call this force the "communities of interest". Those groups or communities of individuals who are interested in social and environmental issues. They have recognized the need to protect the environment and to increase the breadth and depth of the participatory aspects of decision-making. These four groups exist in today's society (Producers, Users, Governments and Communities of interest). Without understanding and communicating between and among these groups the potential for a technology to become successful is significantly decreased.

In the assessment of SPS, these forces are deliberately being brought together. The aim is to manage the potential conflict between these groups through an open exchange of information and views. The need for this action is readily understandable when one recognizes some of the societal trends in the United States which are being mirrored in other countries of the world such as:

- o During the past 50 - 100 years, there has been increasing centralization in Government, business and cities. Today, however, America appears to be moving into a process of decentralization that has begun to have a profound impact on all public policy decisions. States, communities and neighborhoods are increasing their influence and controls. Rural areas are growing. The referenda or initiative process appears to be a powerful trend. In all sections of the country we will be submitting new questions to this political process.
- o In government and technology the trend or phenomena of appropriate scale is replacing the single position of economies of scale. We also are noticing that the introduction of every new technology is necessarily accompanied by compensating human responses or the new technology is rejected. CB radios permit people to extend their communications while still retaining a sense of being private. Medical technology extending the life of people has resulted in the Hospice movement, the human response towards understanding the dignity of death.
- o And finally, the United States and Western Europe are becoming more and more multi-option societies and less and less either-or societies.

Based upon these historical trends linked to the forecasts of population growths and resultant world energy needs, is it not apparent that technological innovation is mandatory? Further, reviews of the world's resources and technological possibilities make it apparent that no one technology can meet all the needs of the future. Rather, appropriate technologies of all scales - decentralized with individual control and medium and large centralized ones will be needed.

These facts and interpretations have served as the philosophical basis for the SPS assessment process.

THE ASSESSMENT PROCESS

The DOE/NASA-CDEP assessment is an evolutionary process, based on past studies, experiments and developing new knowledge within an expanding framework of issues and laying tentative plans for the future.

The assessment process has been designed to facilitate a continuing face-to-face exchange between those involved in the systems definition and technical design investigations, the environmental, societal and comparative assessment efforts. This process is iterative. It recognizes the different groups sometimes have contradictory goals and objectives. It has attempted to manage these potential conflicts by trying to determine at first where they agree and from thence, insuring that as information is obtained, it is immediately supplied to all as part of an overall strategy. Thus, if an environmental concern is defined, this concern can then be discussed in detail with the system designers and technologists to see if a change in the technology could eliminate or mitigate the concern. This is resulting in a most effective working relationship between the individuals involved in the assessment of the SPS concept. The systems definition starts with a reference system from which technical issues may be clearly defined, critical supporting investigations conducted and the results fed back into the systems definition activities. As new concepts and emerging technologies such as lasers or solid state microwaves are identified, new reference systems are configured which again go through the cycle of defining technical issues and carrying on the detailed research. This is aimed at developing a technically preferred system concept. At the same time, the information developed acts as a point of departure to permit the beginning of the overall participatory technology process designed to tie the systems definition activities and the environmental, societal and comparative assessments together. But, most importantly, this process promotes public participation in the formulation of research questions as well as in the review of research findings. The Participatory Technology Process (shown in Fig. 2) starts with the reference system design and the findings from critical supporting investigation. Workshops and expert peer groups scope and define the key issues and concerns vis-a-vis the reference system design. In addition, NASA has conducted a series of in-depth peer review technical workshops covering the major SPS technologies such as large space structures and controls and transportation systems. Assessments or experiments are then conducted. The resultant reports are peer-reviewed. This is followed by presentation of the findings of these studies at periodic program review meetings such as this week's meeting. Thus, all interest groups may participate in monitoring the progress of SPS research activities. The effects of the peer reviews and the program reviews have resulted in significantly improved reports. Through standard distribution, approximately 3,000 copies of each report is disseminated to university libraries, industrial, governmental and environmental organizations and individuals both here and abroad.

To increase public participation in the SPS assessment and to identify and respond to public concerns, a public outreach experiment was conducted. This experiment solicited comments from 9000 individuals: 3000 from each of three diverse public groups. Each of the three groups (The Forum for the

Advancement of Students in Science and Technology (FASST), the Citizens Energy Project, and the L-5 Society) independently summarized 20 SPS reports and distributed them to their constituents with a request for feedback. Feedback responses resulted in 44 composite questions. These concerns and questions were then presented to the principal investigators at universities, national laboratories, private contractors and government agencies responsible for the specific assessment and research to answer. Thus, both the interested individuals and the investigators learned of the ideas and concerns of the other and communications were enhanced.

To obtain a completely independent overview of the CDEP, as an aid in insuring that the key areas are being assessed, the National Academy of Sciences was requested to conduct a review of the work and results of the SPS project. This is being accomplished through the National Science Foundation. The CDEP three-year assessment of SPS will be completed late this summer.

Through review of current literature, analyses, assessments and experiments a solid appreciation of what is known, unknown and uncertain about the many aspects of SPS is being developed. Although many problems and concerns remain to be solved, none at this time appears to be insurmountable.

The SPS assessment has and is proceeding at a logical pace commensurate with our understanding of the issues. In facing the challenge of energy requirements for the expanding world population, we should not, as history has taught us, be timid. Nor should we, as history again has taught us, rush to embrace a technology that may lock us into environmentally or economically unsound concepts. We should, rather, aggressively insure that the essential requirements demanded by our maturing society be the foundation stones for new technologies:

- o Technical excellence
- o Economic viability
- o Environmental acceptability
- o Social acceptability

World Population Growth

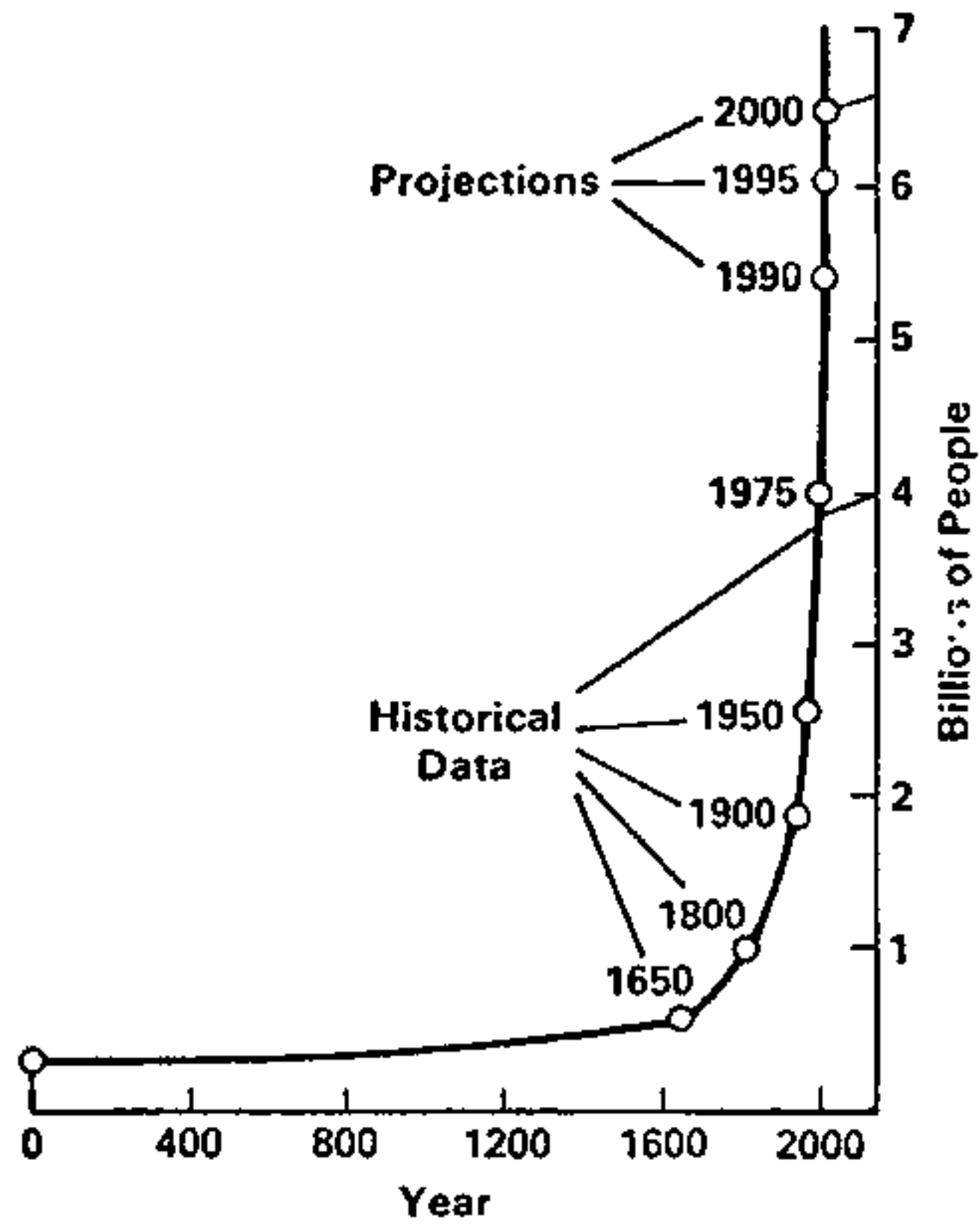

Figure 1

SPS Participatory Technology Process

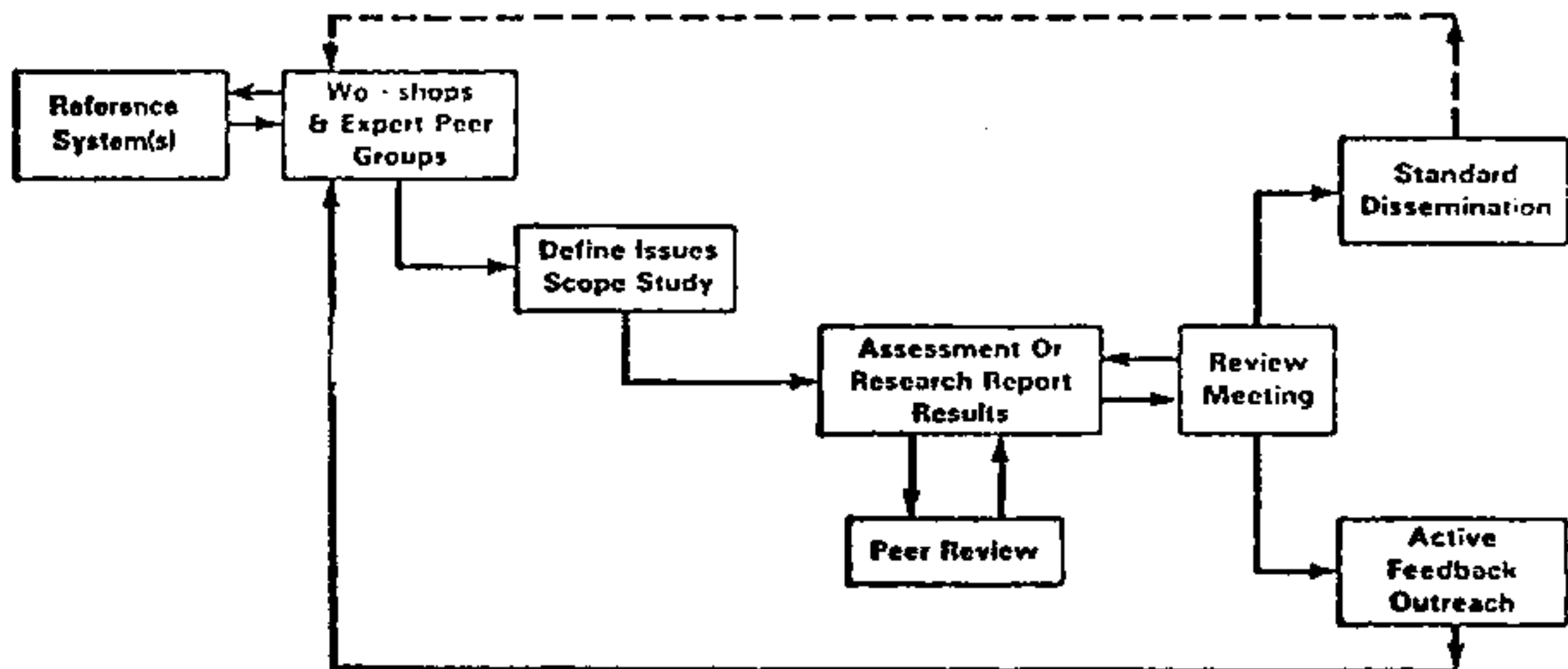

Figure 2

OVERVIEW OF SYSTEMS DEFINITION ACTIVITIES FOR SATELLITE POWER SYSTEMS
F. Carl Schwenk
NASA Headquarters - Washington, D. C.

The Satellite Power System, as shown in the first viewgraph (Figure 1), is a means to gather energy in space and transmit that energy to earth in useful form. The concept shown is merely one of many possibilities for this concept. The Satellite Power System, invented in 1968 by Dr. Peter Glaser of the Arthur D. Little, Inc., has been the subject of design studies, symposia, program reviews by committees and, since 1977, the center of the activity known as the Concept Development and Evaluation Program. The purpose of this paper is to review what has been done during the last three years in the systems definition effort which has been the prime responsibility of NASA. In doing so, it is wise to refer to the total SPS effort conducted by NASA, which began in 1972, because the present lore of SPS is the summation of all past work.

Prior to the Concept Development and Evaluation Program, the scope of SPS activities were as described on the next viewgraph (Figure 2). This chart, taken from a Table of Contents of a report on SPS prepared in early 1977, shows that the studies conducted by NASA included considerations of the role of SPS as an energy system, space technology, ground systems, environmental concerns, and comparisons.

During these pioneering efforts many versions of SPS were studied and contributed to the present state of systems definition in SPS. Both photovoltaic and thermal energy conversion concepts were studied.

One important aspect of SPS is getting it into space in the first place. Various transportation concepts for getting payloads into orbit at the lowest possible cost were studied, including modified shuttles, up-rated shuttles and a variety of advanced vehicle concepts generally known as Heavy Lift Launch Vehicles. These included ballistic single-stage and two-staged vehicles, winged two-stage vehicles for ease of recovery, and single-stage-to-orbit vehicles which could take off from conventional airports. In addition to studies of systems, the early analysis of SPS considered related activities in construction methods, construction locations and facilities, and different transportation methods in space, including chemical rockets for all orbit-to-orbit transportation, and electric propulsion systems using both nuclear energy and solar energy as the prime power source.

From all these studies, the result is a focus on the photovoltaic approaches as being the prime early candidates for an SPS configuration. The choice resulted from a combination of the many factors I've described and represents an integration of many elements of the study efforts.

It should also be noted that the microwave power transmission system has received the most attention in SPS studies. The power transmission system dominates the system design, environmental concerns and, ultimately, implementation of the program. It sets power levels and, therefore, system sizes and masses. For good penetration through the atmosphere, the carrier frequency in the range of one to ten gigahertz is desired. Because great emphasis was placed on obtaining baseload capability in satellite power systems, a frequency of 2.45 gigahertz in an available industrial, scientific and medical (ISM) band of the electromagnetic spectrum was selected for most of the study effort. Consideration was given also to frequencies of 5.8 and 8.0 gigahertz. For the 2.45 giga-

hertz frequency the transmitter and ionospheric thermal limits set 5 megawatts as the maximum power that could be delivered in a single beam; however, lower powers per beams are possible. It was assumed that obtaining the maximum power level for a given size of transmitter system would result in the most economical power plant.

Though we have the example of the Goldstone test as one experiment related to the satellite power system, it is significant to realize that nearly all of the efforts on SPS have been studies based on assumptions and projections of where the technology may be in the future, and ought to be in the future, in order to achieve a satisfactory power system. Supporting the SPS studies, however, are broadly based NASA and DOD space research and technology programs covering nearly all the technical disciplines important to SPS. Studies conducted outside the SPS program showed that laser power transmission could possibly be feasible in space missions and for delivering power to Earth. An output of one of these early studies of laser power transmission is illustrated in this picture (Figure 3) which shows a system where the power plant is in low Earth orbit and laser relays are placed in geosynchronous orbit in order to achieve delivery of power to a single spot on Earth.

With this background I believe you can see then that SPS has had a history of studies and relies heavily on R&T activities being conducted outside the SPS program, that are supportive of the Concept Development and Evaluation Program, which I will now discuss. In the systems definition effort, which has been the responsibility of NASA, the objective has been to define a baseline system concept or concepts to evaluate technical feasibility and to provide information required for environmental and socio-economic assessments. As time has gone on in the Concept Development and Evaluation Program, the initial objectives in systems definition were expanded to include studies of alternative approaches and to conduct critical supporting investigations where needed and as may be possible.

One of the first requirements of the Concept Development and Evaluation Program was to establish a reference Satellite Power Systems concept for use in conducting evaluations of environmental impact, societal concerns, and comparative assessments. In order to establish a reference system, common guidelines (Figure 4) were established based upon the judgment derived from the earlier studies which I have just described. Many people can and have quarreled with these guidelines; however, it was necessary to establish some basis for conducting the studies. As further work is done on SPS, it will be necessary to examine the impact of changing these guidelines to determine whether more optimal or more favorable versions of SPS might be derived from different starting assumptions.

From these guidelines and the studies which have been conducted over the years, the reference satellite power system concept was established. The general concept is outlined on this viewgraph (Figure 5). It shows a large flat structure (5 Km x 10 Km) holding solar arrays for generating DC power from the sun. The DC power is collected and delivered by means of a rotary joint to a transmitting antenna system. The transmitting antenna was set at 1 kilometer in diameter and it is formed of transmitting antenna subarrays which contain the DC-RF power

amplifiers and the antenna waveguides for forming the beam. The beam is controlled in the reference system by a retro-directive pilot beam system. In travelling from geosynchronous orbit to the Earth, the microwave power beam expands in area from a circle 1 kilometer in diameter to an ellipse that is 10x13 kilometers at the 35° reference latitude. It is now a low power density microwave beam with a peak intensity of 23 milliwatts per square centimeter in the center and 1 milliwatt per square centimeter at the edge of the rectenna. The rectenna is made of a series of panels which contain an open screen ground plane with half-wave dipole antennas and diode rectifiers. DC current is collected and delivered to the peripheral rectenna where it is processed for distribution to the electrical network.

Artist illustrations of two versions of the reference system are shown on the next viewgraph (Figure 6). One version of the reference system uses silicon solar cells in a planar array without concentration of the solar energy. A silicon reference was included in the study because of the vast amount of experience available now and expected with silicon technology in the future. The gallium aluminum arsenide solar cell version was included as a reference system because the gallium aluminum arsenide solar cells have several advanced features which make them attractive for use in the satellite power system.

The next chart (Figure 7) shows the comparison of the two reference systems in terms of their mass in millions of kilograms. We see that the total mass for the gallium aluminum arsenide array option is in the range of 34 million kilograms while that for the silicon option is in the range of 51 million kilograms. If transportation costs were the determining factor, obviously the gallium aluminum arsenide version would be chosen because of its much lower mass; however, the gallium aluminum arsenide solar cells are likely to be considerably more expensive than the silicon, at least in terms of current projections. Also there are some greater degrees of uncertainty on the achievement of performance desired in one solar cell option versus the other.

In addition to the definition of the reference system, which will be covered in much greater detail in other sessions of this Symposium, the NASA activities in the Concept Development and Evaluation Program included studies in many of the critical areas of SPS and associated areas of critical supporting investigations. The next viewgraph (Figure 8) shows a table of funding of the NASA activities during FY 1977-1980, the years of the Concept Development and Evaluation Program, and shows how the funds were expended in the major areas of endeavor. As can be seen, approximately \$7.9 million were expended for systems activities during the Concept Development and Evaluation Program. Of this total, \$2.2 million was spent on systems definition activities which are those functions and studies which integrate all the other work into comprehensive system concepts. You can note that most of the effort was accomplished during the first two years in systems definition for the preparation of the reference system, as I have just discussed. The footnote also indicates that we have been able to put some small amount of money into additional studies of laser energy transmission as an option for the satellite power systems concept. Some results of the laser system studies will also be given later in this Symposium.

Another major area of emphasis in the systems activity has been in the area of

power transmission and reception. Microwave power transmission is certainly a critical element in the feasibility of the satellite power system concept and warrants this level of attention.

I would now like to say a few things which will relate to results of some of these activities during the Concept Development and Evaluation Program. First, I would like to discuss the use of solid state microwave converters which was mentioned earlier. We conducted research on the application of solid state converters and studies of concepts which might use these devices in place of klystrons or other tube type converters because of the potential for high reliability in solid state devices. One version would be to make a simple replacement of the klystron tubes with an array of many millions of small DC-RF converter transistors. And this has been studied under the Systems Definition portion of the program. Another radical approach to using solid state converters is to create what we call a sandwich of solar cells, circuitry and solid state DC-RF converters which would be mounted on satellites as illustrated in this viewgraph (Figure 9). Here we show two versions where the microwave transmitting antenna is actually the sandwich structure. One face contains the waveguides and the DC-RF converter transistors and the other side contains the gallium aluminum arsenide solar cells, which are illuminated by a system of reflectors.

A great deal of importance in the SPS studies have been placed on the matter of construction. In fact, considerations of construction operations has played a large role in the selection of the reference system concepts. Studies have also been made of the ground operations required to support the building of the rectenna and the industrial demands of SPS.

In addition to the activities I've described, a number of significant items of work have been accomplished in the systems studies activities. Among them are the studies of variations in launch trajectories for the Heavy Lift Launch Vehicles required to deliver payloads to low Earth orbit to reduce the impact of the effluents from the rocket engines on the ionosphere. Studies are also under way to explore alternative designs for the launch vehicles in order to determine what is the most favorable concept for delivery of payload into orbit.

Studies of alternative power levels and transmitting frequencies for satellite power system have been conducted. At the reference frequency of 2.45 gigahertz, larger antenna systems with smaller rectennas and lower power outputs are economically feasible under certain conditions as shown by these studies. It was also shown that satellites operating at 5.8 gigahertz transmitting frequency instead of 2.45 gigahertz were feasible and could provide power within an economic range or costs. Studies also showed that multiple antennas on the satellite power system were feasible and perhaps desired in order to make best use of the orbital spacings available at geosynchronous altitudes.

In order to obtain expert assessment of the results of the Systems Definition studies and technology investigations that NASA has conducted during the SPS Concept Development and Evaluation Program, the NASA Centers involved sponsored five workshops addressing the major SPS technology areas. These workshops are listed on the next viewgraph (Figure 10). The results and findings of these

workshops are being reported and will be discussed during this conference, but I would like to give a very brief summary of their findings as a capstone to this discussion of the systems studies effort which NASA has conducted.

In the microwave power transmission area, the workshop panel reported that there was cautious optimism that the SPS microwave power transmission system is probably technically feasible; however, a long-term R&T program will be needed in order to prove the capabilities of this complex operation of transmitting power from space to Earth. In structures and controls, the workshop panel report indicates that substantial work remains to be done in modeling and in techniques of active control for structures the size of SPS. In the construction and materials workshop, the findings were that the assembly concepts appear credible but much more R&D work is needed in this area. One important lack is the insufficient data on the long-term behaviour of composite materials in geosynchronous orbit. The panel recommended that, in addition to the composite structural materials in the reference system, aluminum structures also be given continued consideration. In space transportation it was recognized that the propulsion systems for the reference heavy lift launch vehicle are achievable without high risk. It was also thought necessary to keep open many of the propulsion options before a firm choice is made. Reusable thermal structures will require a major development program and the key issues in space transportation remain the solution of problems related to repeated operations of space vehicles. This technology will be developed, in part, through the operation of the Shuttle. Under energy conversion and power management it was noted that key technology advances are needed, for example, in the solar blankets, the solar cell encapsulants, waste heat radiators, and the high speed switch gear. There can also be a major concern in the area of operation of satellite systems at the extremely high voltages required by the reference system.

The question at this time must be, "What are the major findings of the systems studies activity in the Concept Development and Evaluation Program?" Those of us close to the program feel that the concept of transmitting power from space to Earth is not faced with insurmountable technical problems; however, this judgment is based in large part on studies that rely on assumptions and projections of critical technology disciplines. It is only through further research and experiments that we can change these assumptions to hard data, and it is only with hard data that we will be able to give an unqualified statement as to the technical and economic viability of any SPS concept.

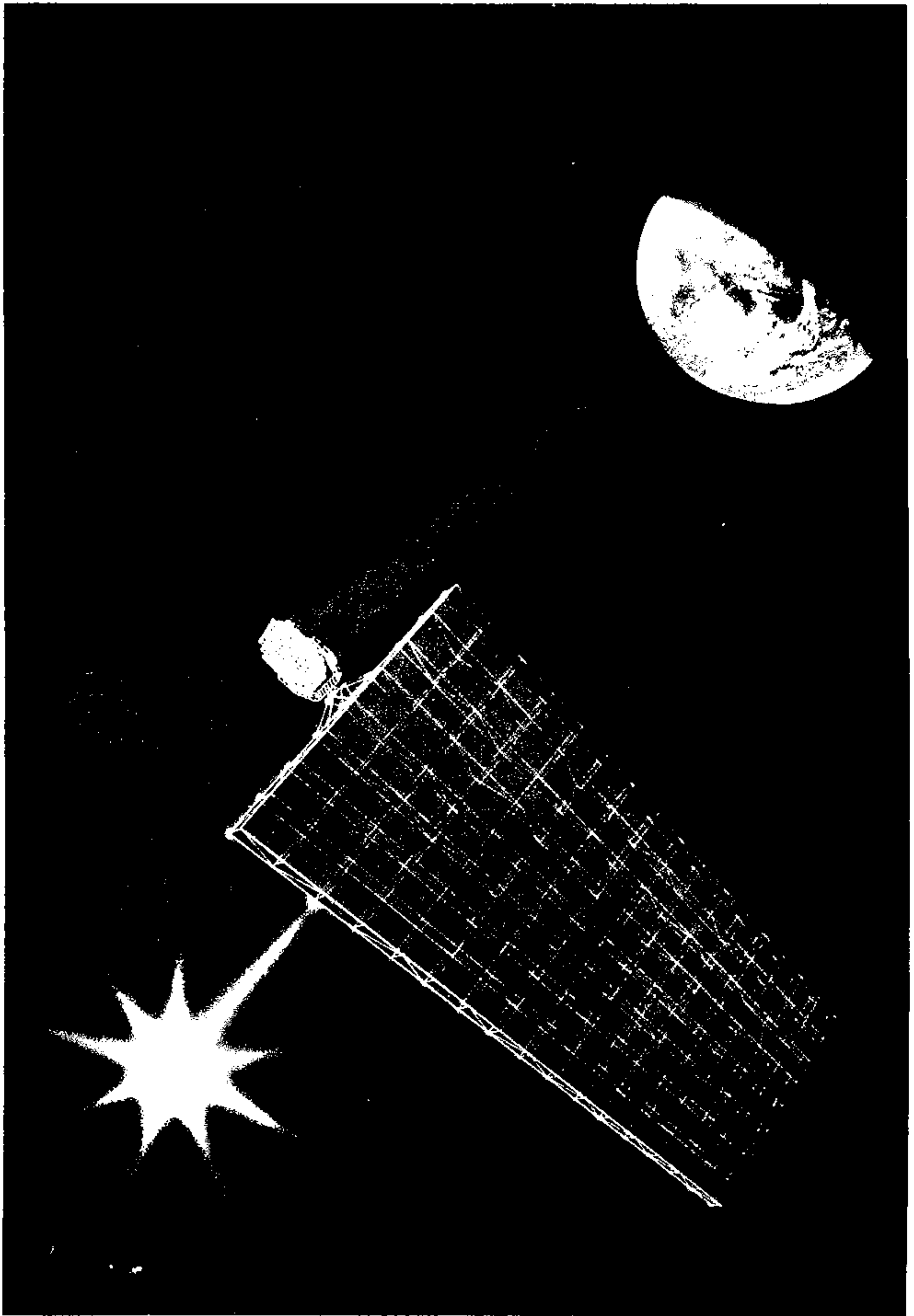

Figure 1

SCOPE OF NASA STUDY EFFORT BEFORE 1977

- PROGRAM REQUIREMENTS
- SATELLITE POWER STATION (SPACE SYSTEM)
- SPACE CONSTRUCTION AND MAINTENANCE
- SPACE TRANSPORTATION SYSTEMS
- ENVIRONMENTAL FACTORS
- MANUFACTURING, NATURAL RESOURCES, GROUND TRANSPORTATION AND ENERGY CONSIDERATIONS
- PROGRAM PLANNING AND COSTS
- ALTERNATIVE SYSTEMS COMPARISONS

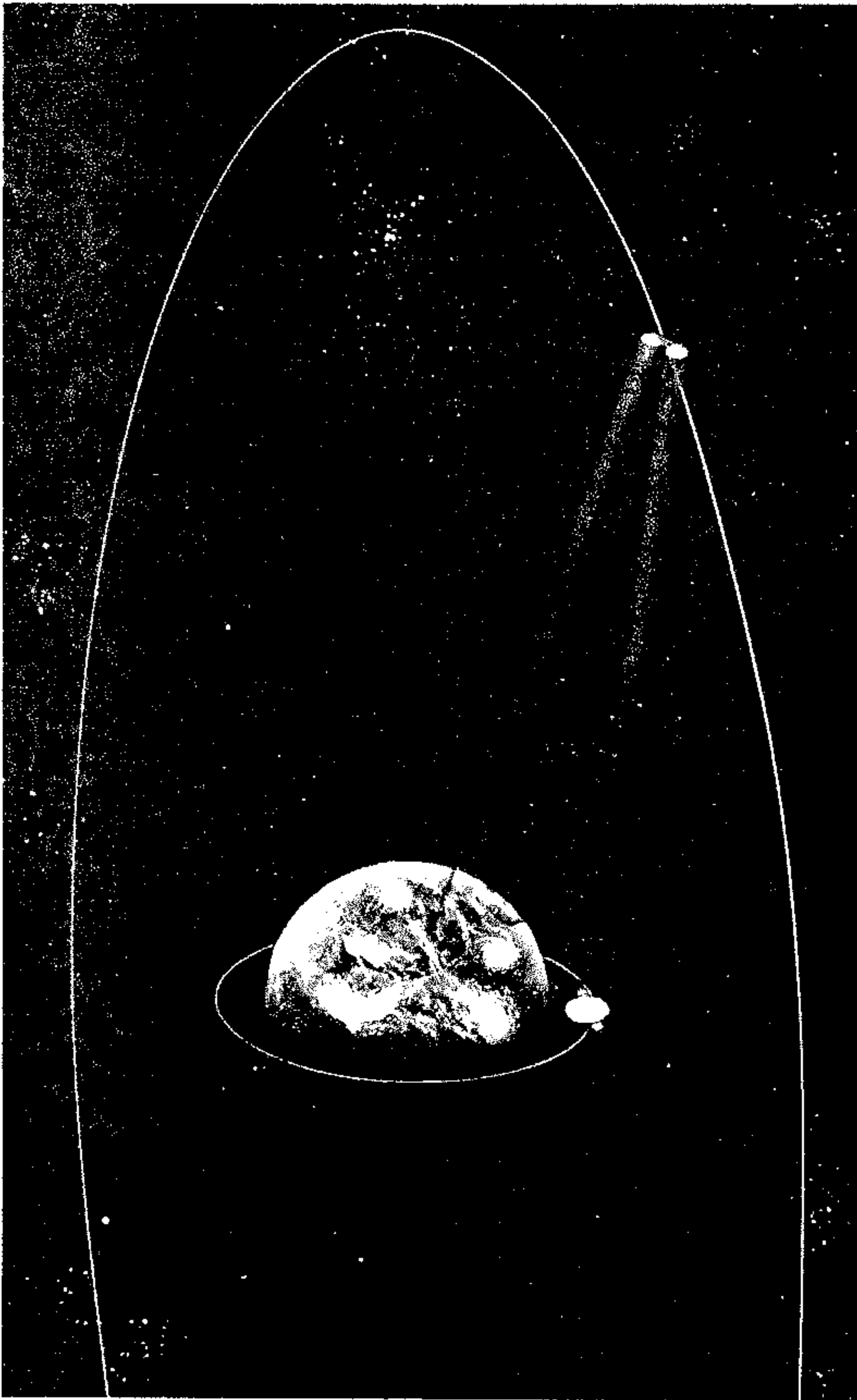

Figure 3
Initial Laser SPS Concept

NASA

**Solar Power
Satellite**

**Evaluation Study
Guidelines**

For the purposes of the Solar Power Satellite Evaluation Program common guidelines were established which were based upon judgement derived from earlier studies.

Initial operational date for commercial satellites — 2000
Technology availability — 1990

Construction materials obtained totally from earth resources
Operational satellite in geosynchronous orbit

Microwave system operating frequency — 2.45 GHz industrial band

Microwave power density not to exceed 23 mW/cm^2 in the ionosphere
Microwave system sized to provide 5 GW output from rectenna

Reference implementation rate assumed to be two 5-GW solar power satellite systems per year (10 GW total)

Solar power satellite design lifetime of 30 years

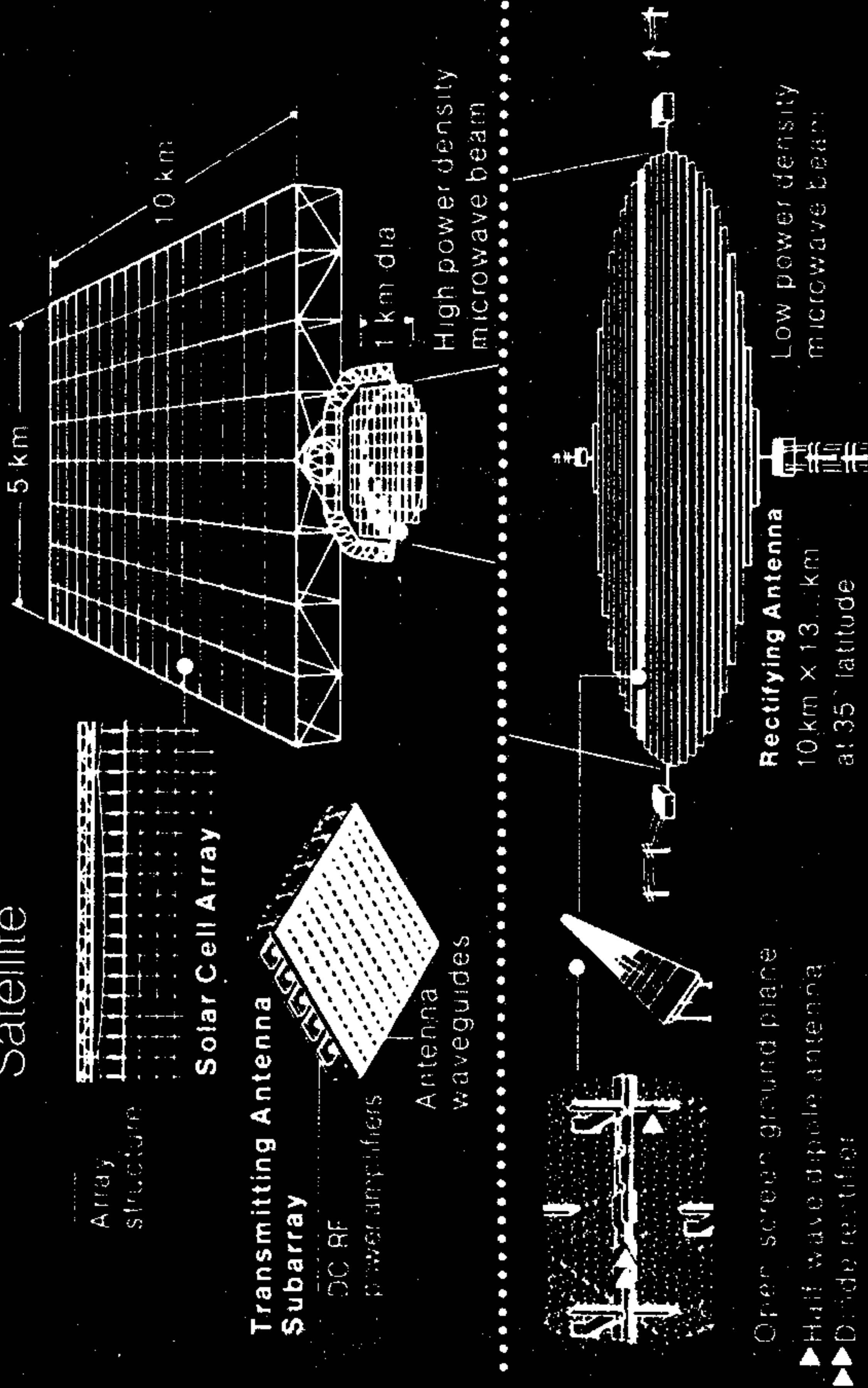
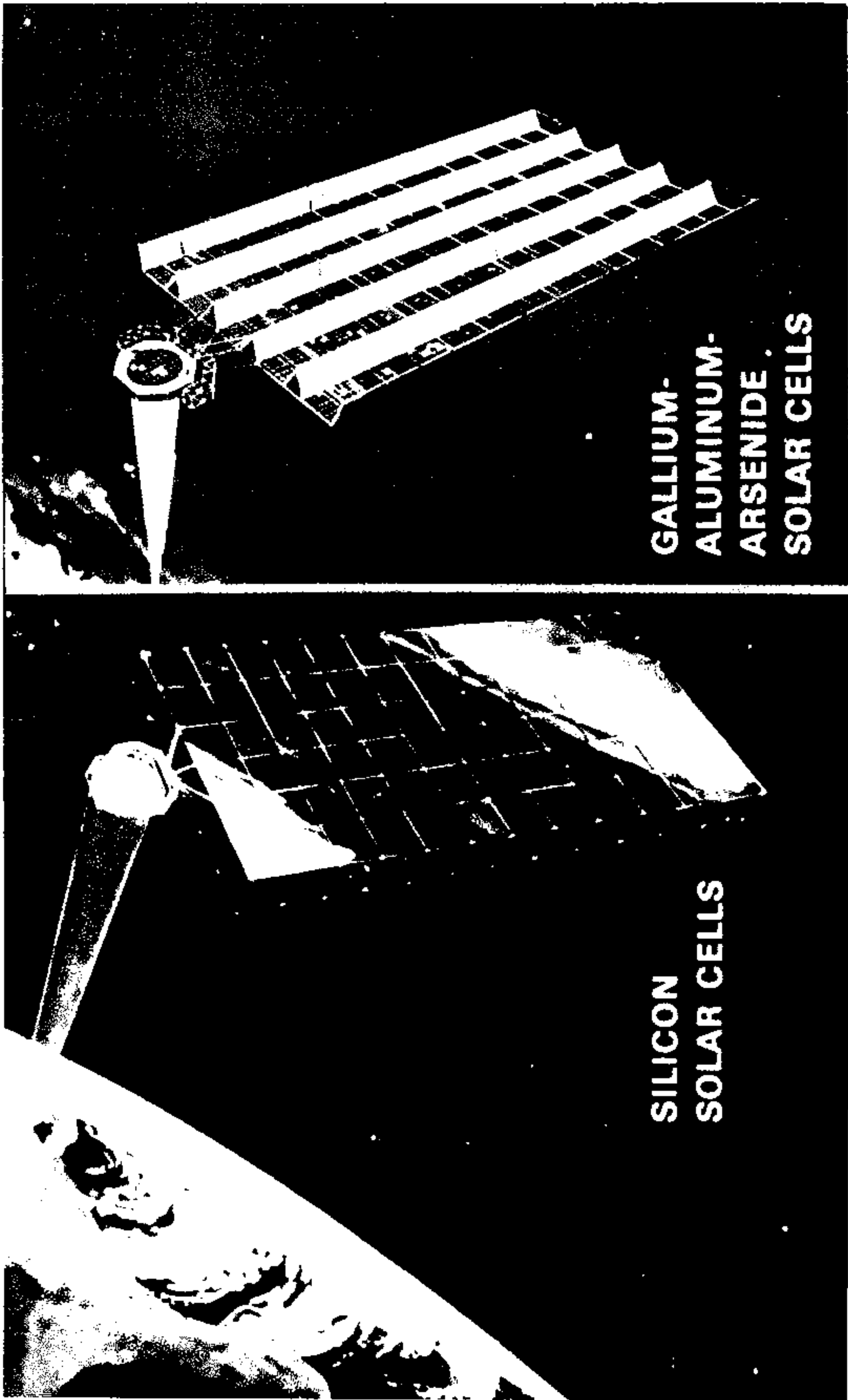

Figure 5



**GALLIUM-
ALUMINUM-
ARSENIDE
SOLAR CELLS**

**SILICON
SOLAR CELLS**

Figure 6
Reference System Concepts

NASA Solar Power Satellite		Satellite Mass Summary	
Millions of Kilograms			
	GaAlAs Array Option CR=2	Silicon Array Option CR=1	
Solar Array	13.8	27.3	
Transmitting Antenna	13.4	13.4	
Array - Antenna Interfaces	.1	.1	
Sub total	27.3	40.8	
25% Contingency	6.8	10.2	
Total	34.1	51.0	

Figure 7

SATELLITE POWER SYSTEM
 CONCEPT DEVELOPMENT AND EVALUATION PROGRAM
 SYSTEMS ACTIVITY FUNDING ~ \$K

	FY 77	FY 78	FY 79	FY 80	TOTAL
SYSTEMS DEFINITION	715	765	235	490**	2,205
SOLAR ENERGY CONVERSION	85	60	100	50	295
ELECTRICAL POWER PROCESSING & DISTRIBUTION	150	50	100	-	300
POWER TRANSMISSION AND RECEPTION	735	565	1,240*	260	2,800***
STRUCTURES/CONTROLS AND MATERIALS	200	165	285	150	800
OPERATIONS	150	225	490	50	915
SPACE TRANSPORTATION	165	170	150	100	585
TOTAL	2,200	2,000	2,600	1,100	7,900

* INCLUDES \$400K FOR SOLID STATE SPS

** INCLUDES \$125K FOR LASER SPS

*** INCLUDES \$700K FOR MW AT JPL

Figure 8

**PRELIMINARY CONCEPTS EMPLOYING
SOLID-STATE MICROWAVE CONVERTERS**

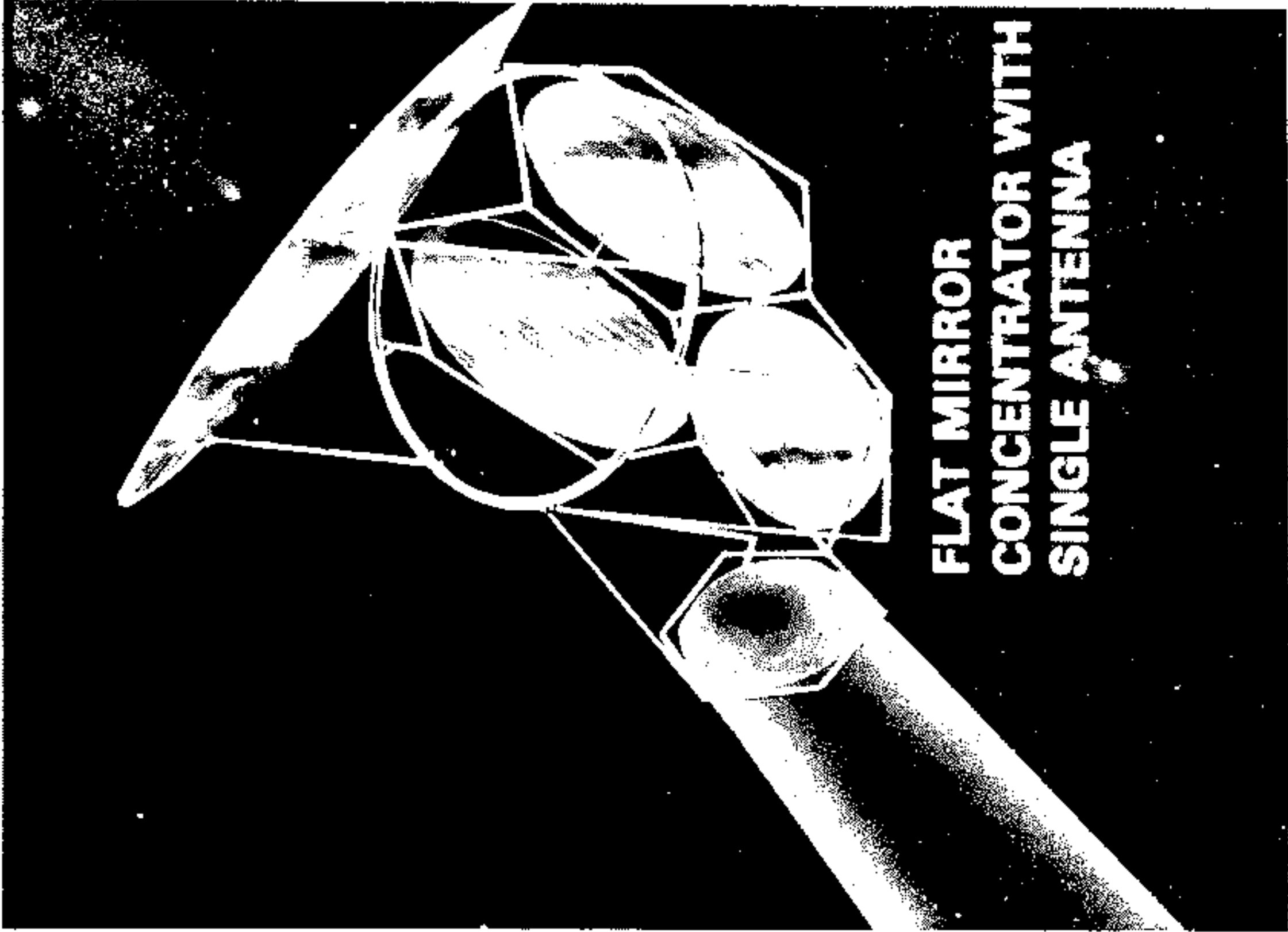

**FLAT MIRROR
CONCENTRATOR WITH
SINGLE ANTENNA**

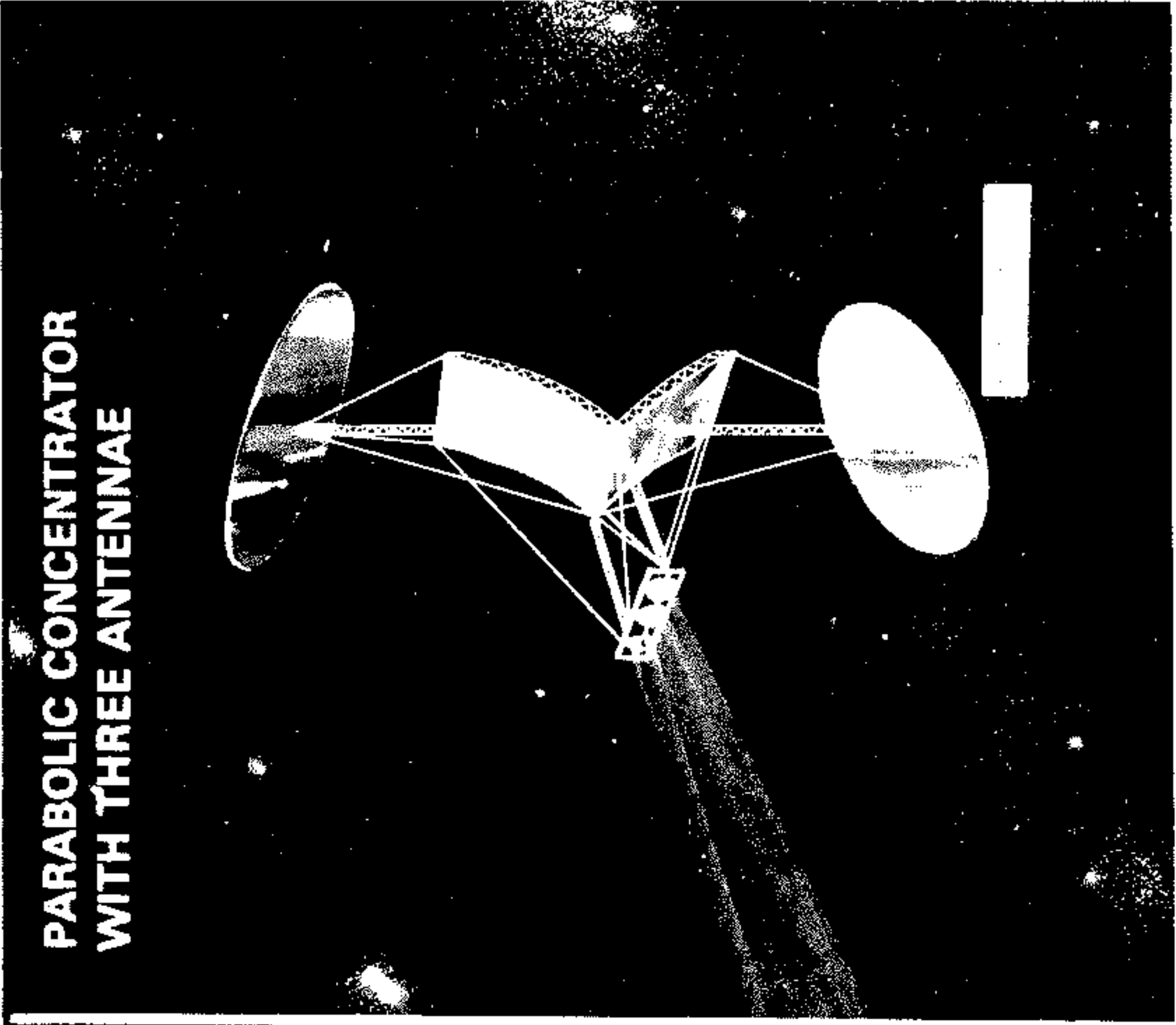

**PARABOLIC CONCENTRATOR
WITH THREE ANTENNAE**

Figure 9
Preliminary Concepts Employing
Solid-State Microwave Converters

SPS TECHNICAL WORKSHOPS

JSC MANAGED WORKSHOPS

<u>DISCIPLINE</u>	<u>CHAIRMAN</u>	<u>DATE</u>
● MICROWAVE POWER TRANSMISSION	DR. J. FREEMAN, RICE	JAN 15-18, 1980
● STRUCTURAL DYNAMICS & CONTROL	DR. B. MINGORI, UCLA	JAN 22-23, 1980
● CONSTRUCTION AND MATERIALS	DR. R. MILLER, MIT	JAN 24-25, 1980

MSEC MANAGED WORKSHOPS

<u>DISCIPLINE</u>	<u>CHAIRMAN</u>	<u>DATE</u>
● TRANSPORTATION	DR. R. JAHN, PRINCETON	JAN 28-30, 1980
● ENERGY CONVERSION & POWER MGMT	DR. J. R. WILLIAMS, GIT	FEB 5-7, 1980

ENVIRONMENTAL ASSESSMENT OVERVIEW

A. R. Valentino
Argonne National Laboratory

INTRODUCTION

For the Concept Development and Evaluation Phase (CDEP) of the Satellite Power System (SPS) Program, the environmental assessment program component has as its objectives:

- to identify the environmental issues associated with the SPS Reference System;¹
- to prepare a preliminary assessment based on existing data;
- to suggest mitigating strategies and provide environmental data and guidance to other components of the program as required;
- to plan long-range research to reduce the uncertainty in the preliminary assessment;
- to initiate research on particularly sensitive issues.

The key environmental issues associated with the satellite power system concern human health and safety, ecosystems, climate, and interaction with electromagnetic systems. Five tasks have been established to address these issues:

- Task 1 · Microwave Health and Ecological Effects
- Task 2 · Nonmicrowave Health and Ecological Effects
- Task 3 · Atmospheric Effects
- Task 4 · Effects on Communication Systems due to Ionospheric Disturbance
- Task 5 · Electromagnetic Compatibility

In Task 1 the potential effects of microwave energy on SPS workers, the general public, and ecosystems are evaluated. Other possible health and ecological impacts of the satellite power system are examined in Task 2, including the effects of the space transportation system, ionizing radiation in space, occupational risks due to manufacturing, and air and water pollution. Task 3 comprises characterization of potential atmospheric disturbances due to the SPS and assesses climatic impacts, including the effects of rocket effluents on the atmosphere. The impacts of ionospheric disturbances (caused by microwave heating and space-vehicle effluents) on communications systems which use the ionosphere for radio wave propagation are evaluated in Task 4 and in part in Task 3. The direct effects of the microwave power transmission system on communication and other electromagnetic systems are addressed in Task 5. These include direct and scattered power effects, power at harmonic frequencies, and spurious power sources.

Specific environmental issues have been identified for each of the five tasks and a preliminary assessment has been performed based on

existing data. No environmental problem has yet been identified which would preclude the development of the satellite power system technology. To increase the certainty of the assessment, some research has been initiated and long-term research is being planned.

The current environmental assessment has been summarized in the Preliminary Environmental Assessment for SPS.² The final revision of the Preliminary Environmental Assessment will be completed later this year.

MICROWAVE HEALTH AND ECOLOGICAL EFFECTS

The Satellite Power Reference System delivers microwave power developed on the solar collecting satellites in geosynchronous orbit to the very large receiving antennas (rectennas) on the earth's surface. The power beam is an unmodulated continuous wave at a frequency of 2.45 GHz. This task is concerned with the effects of this microwave beam on the health of the SPS worker in space and on earth, the health of the general population, and the ecosystem. In the Reference System the power density at the center of the beam near the transmitting antenna in space would be as high as 2200 mW/cm². The power density of the beam at the center of the rectenna is 23 mW/cm² and the power density as a function of distance from the center of the rectenna is shown in Figure 1. The power density at the edge of the rectenna is 1 mW/cm² and 0.1 mW/cm²

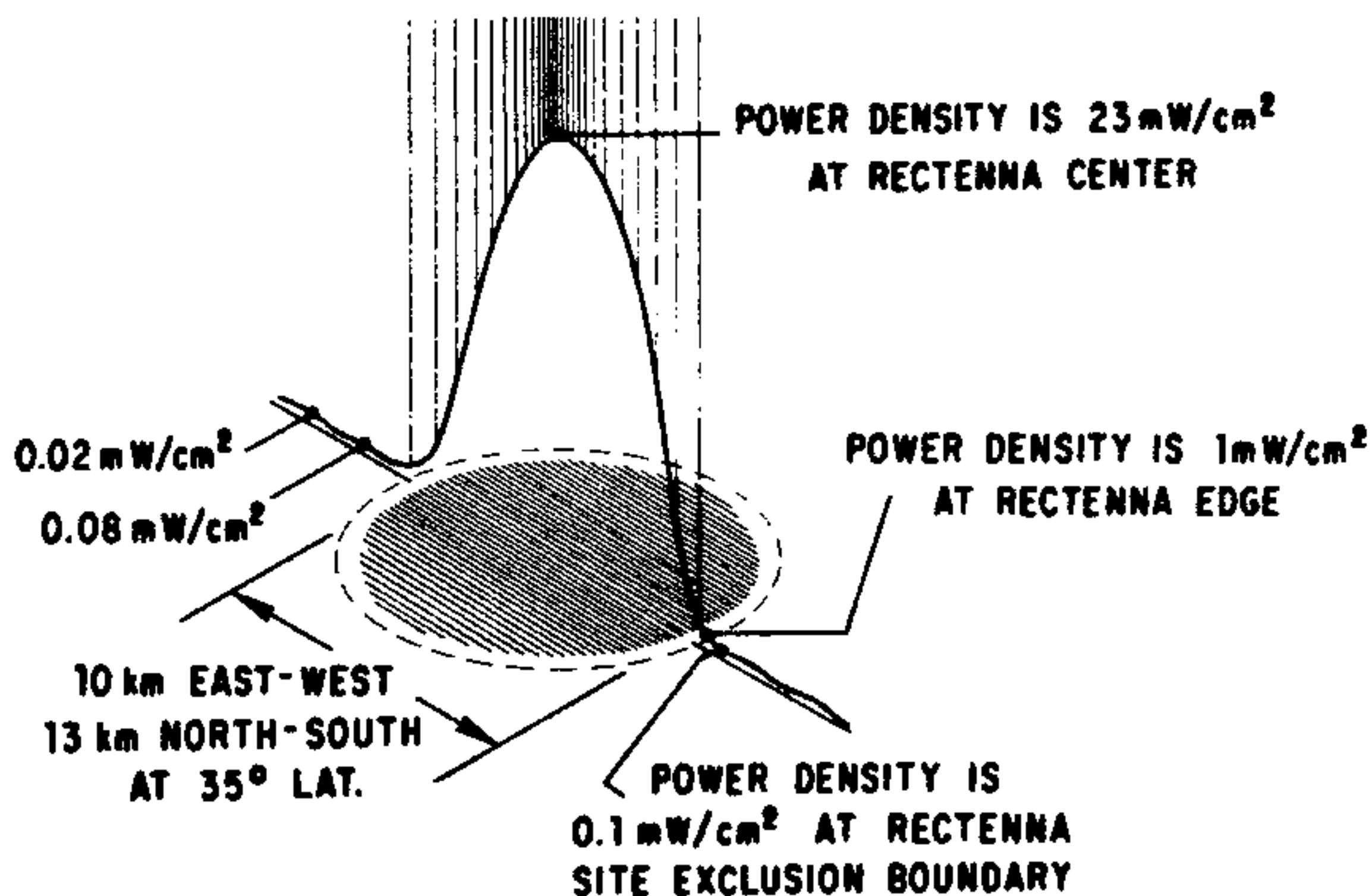

Fig. 1. SPS Microwave Power Density Characteristics at Rectenna Sites

at the exclusion boundary. If there were sixty rectennas in the continental United States spaced an average of 300 km apart, the tails of the power beam patterns would combine and the minimum power density at any point would be about 10^{-4} mW/cm².

These values have been compared to standards and guidelines for exposure to radio frequency power. In the USSR, the official maximum permissible average power densities for people occupationally exposed to radio frequency power in the frequency range from 300 MHz to 300 GHz emitted from stationary antennas are 10^{-2} mW/cm² for a full working day, 10^{-1} mW/cm² for two hours, and 1 mW/cm² for 20 minutes. The maximum value for continuous (24 hour) exposure of the general population is 10^{-3} mW/cm². The United States has no official maximum permissible exposure limit for radio frequency power for the general population. The Occupational Safety and Health Administration (OSHA) has promulgated a protection guideline of 10 mW/cm² for persons occupationally exposed for greater than six minutes to power in the frequency range from 10 MHz to 100 GHz based on the same guideline value of the American National Standards Institute, and this guideline has been adopted by a number of organizations, including the DOD.

SPS power density levels can be indirectly compared with background or ambient radio-frequency power densities. The EPA is measuring environmental field intensities at selected locations within various U.S. cities to permit estimations of cumulative fractions of the total population being exposed at or below various power density levels. A recent report³ presents the results for 15 cities, a total of 486 sites. The report concludes that, of the population group studied representing 20 percent of the total U.S. population, a median exposure value of about 5×10^{-6} mW/cm² time averaged power density exists and less than 1 percent of the population is potentially exposed at levels above 10^{-3} mW/cm². It was observed that the FM radio broadcast service (88-108 MHz) is responsible for most of the continuous illumination of the general population. Direct comparison with SPS cannot be made because of the frequency difference. Nevertheless, these data provide us with a measure of the ambient nonionizing radiation.

The SPS workers within the rectenna area would not need to be exposed to levels exceeding current U.S. guidelines if precautions are taken and protective clothing used in some areas. The public near a rectenna would be exposed to levels in excess of the USSR standard and nearly all of the general population would be exposed to levels greater than the current background. Before this is done, a quantitative assessment of the risk associated with this exposure must be developed. Currently, the data necessary to make a quantitative assessment is not available. Furthermore, controversy exists over whether or not adverse biological effects should be expected for low level (less than 0.1 mW/cm²) power densities.

For these reasons, as well as the fact that there is only a limited amount of data applicable to the SPS, conclusions regarding the potential

biological implications of the SPS microwave power transmission system remain tentative and qualitative at this time. Additional substantive, pertinent data are required before a decision can be made to deploy the SPS.

The following list summarizes present knowledge (based on conventional scientific interpretation of existing data) of the potential effects of SPS microwave energy on biological systems in space, at rectenna sites, and outside rectenna sites.

- Immunology and Hematology
 - Effects in space largely unknown
 - Effects at rectenna sites possible
 - Effects beyond rectenna sites unlikely
- Mutation
 - Effects unlikely in space or terrestrial environments
- Cancer
 - No effects expected
- Reproduction
 - Potential effects unknown in space and on rectenna sites
 - Small risk of effects elsewhere
- Development
 - Effects unlikely except for species inhabiting rectenna sites
- Growth
 - Effects unlikely
- Behavior
 - Effects on SPS workers and other species endemic to rectenna sites possible
 - Effects beyond rectenna sites uncertain
- Physiology and Integrative Processes
 - Effects in space and at rectenna sites possible
 - Effects beyond rectenna sites unlikely
- Interactive Situations, Medications, and Special Populations
 - Possible adverse but largely unpredictable implications

~~On the basis of this qualitative assessment~~ public health effects appear unlikely; however, there is some small risk concerning human reproductive processes and an uncertainty about behavioral effects. Risks for persons in poor health, receiving medications, or under stress may be somewhat higher than for other members of the public, but this likelihood cannot be assessed with confidence at this time.

Workers at SPS rectenna sites would be exposed to higher levels of microwave energy than the public, with a proportionately higher risk of health effects. If health effects were to occur, they probably would affect the body's immune and blood systems, reproduction, general physiology, or behavior. The effects on spaceworkers of an accidental exposure to the relatively strong microwave energy in space are practically unknown, as there is almost no experience to which the SPS situation can be related. Undesirable effects might be possible.

Microwave energy beams in the lower atmosphere and at rectenna sites have the potential to affect airborne and terrestrial animals that reside at or pass through rectenna sites. The greatest potential effects would be expected on immune or blood systems, reproduction processes, physiology, and behavior.

In the current assessment of SPS almost all of the microwave exposure effects are ascribed to the biological effects of the heating produced by microwave energy. It is conceivable that levels of microwave energy too low to increase body temperatures measurably may nevertheless cause subtle, possibly important, changes in biological processes. The open question of nonheating effects thus increases the uncertainties in this assessment.

Because of the lack of data on microwave biological effects, research is being started on airborne biota and immunology and hematology, teratology, and behavioral effects in animals. Airborne species are of high priority since some can be expected to inhabit or pass through typical rectenna sites.

Extensive research is required to support a quantitative assessment of microwave effects on human health and the ecosystem. The assessment is needed to estimate the impacts of the SPS system, guide the design of an SPS microwave transmission system, and provide a base for international standards of microwave exposure.

NONMICROWAVE HEALTH AND ECOLOGICAL EFFECTS

Development of the satellite power system would require extracting certain natural resources, shipping those resources to factories for processing and manufacturing, transporting finished products to a launch site, and launching the products (and construction workers) into space for orbital assembly of the satellites. Relatively large areas of land

also would need to be cleared so that SPS rectennas could be built; manufacturers would ship rectenna components to these sites. Space transportation vehicles would have to be built, either in manufacturing plants or at SPS launch sites.

Most of these activities would be conventional processes normally associated with mining, manufacturing, and transportation. Their environmental consequences also may be regarded as conventional, and potential SPS-related impacts can be assessed on the basis of experience with closely-related activities. Many of these conventional impacts would occur even if the SPS is not developed, as a result of the development of other new power sources.

However, the space activities associated with the satellite power system must be given special consideration. The scope of SPS activities--especially if a large number of satellites were placed in orbit--would greatly exceed the extent of other space activities to date. Thus an analysis of environmental impacts resulting from SPS space activities is a formidable task. Because of the limitations of the existing data base, much of the present analysis is still qualitative rather than quantitative.

SPS depletion of resources, conventional air and water pollutants and waste products could be locally significant and noticeable to the public near industrial centers and SPS rectenna and launch sites. None of these impacts is peculiar to the satellite power system, with the exception of noise generated by SPS rocket launches. All effects could be controlled to some degree by conventional strategies.

Workers in industries supporting SPS development would be exposed to the same kinds of environmental effects as the public but their level of exposure would often be greater. They also would risk conventional occupational illnesses and injuries. Available industrial safety measures appear to be adequate to maintain SPS-related risks at generally-accepted levels.

The principal risks to space workers, as depicted in Figure 2, have been identified based on present knowledge and experience.

Space workers could be injured in SPS launch accidents and during space travel. To date these risks have been faced by only a few people who have been intensively trained for space travel. For SPS, many more individuals would be exposed to these risks, and the level of training might be different than that possible for small groups of people.

One of the principal issues is the ability of humans to work efficiently in space for extended periods of times without undue risk of life shortening or persistent disability. The Apollo and Skylab programs have provided data relevant to this issue. This data has been studied and the conclusion has been reached that there is no substantial evidence to indicate that unpreventable or noncorrective adverse effects will be

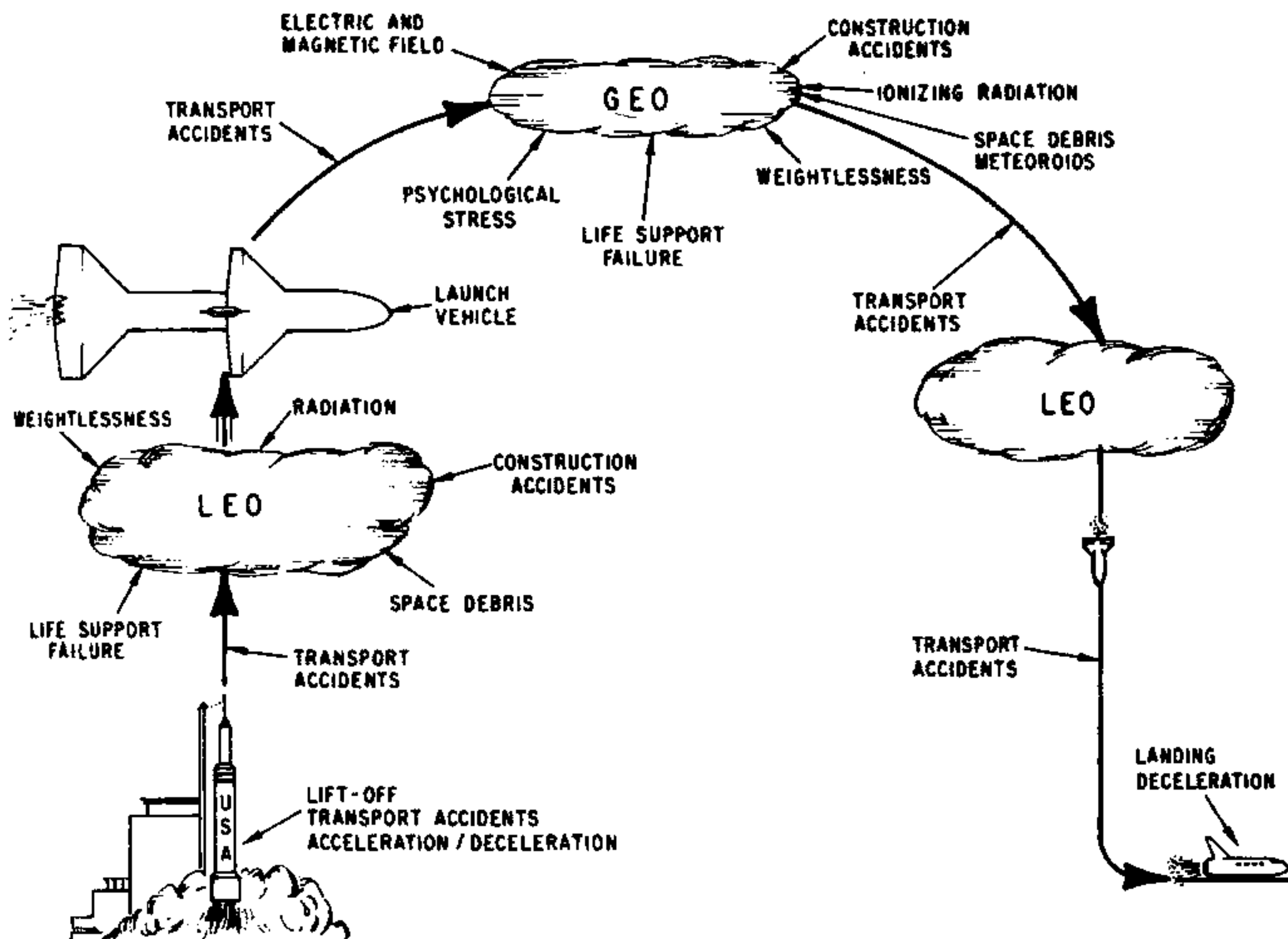

Fig. 2. SPS Environmental Effects on Space Workers

experienced by SPS space workers. Furthermore, although additional potentially adverse effects may be identified in the future, counter-acting or ameliorating measures can probably be developed to avoid these effects.

The predominant types of ionizing radiation which occur in space are known. The high-energy heavy ions (known as HZE particles) that would be encountered in space are of particular concern. Preliminary calculations made for HZE and other types of predictable ionizing radiation for SPS space workers indicate that radiation doses might exceed current limits recommended by national and international commissions on radiation protection. Unpredictable radiation, from solar storms for example, are also of concern. The risks from ionizing radiation in space could be minimized through carefully-designed shielding for space vehicles, working and living modules, and solar storm shelters. A warning system could be developed to protect workers from excessive, unpredictable space radiation. In addition, special monitoring systems would be necessary to obtain comprehensive, immediate accounts of radiation conditions in places occupied by space workers. Personnel dosimeters with quick readouts also would be required because of differences in

exposure among individuals performing different tasks under varying conditions and work schedules.

Ecosystems might be affected by pollutants from industrial activities supporting SPS development; these effects would be the same as those from activities supporting other energy supply endeavors. The effects of some pollutants on ecosystems are not entirely understood. Site-specific environmental impacts undoubtedly would have some effects on species that normally would inhabit SPS rectenna sites. These impacts might include changes in habitat and natural order of succession. A study of a hypothetical rectenna site in California will quantify representative site-specific impacts. Other principal ecological effects, yet to be quantitatively assessed, might stem from light reflected from power satellites and acoustic noise near launch and landing sites. Both of these, however, can be expected to be either minor perturbations or subject to mitigation by appropriate engineering changes.

SPS EFFECTS ON THE ATMOSPHERE

Every level of the earth's atmosphere would be affected to some extent by the construction and operation of a satellite power system. Atmospheric effects resulting from space transportation and satellite operation are the principal considerations of this task. The effects of rectenna operation are also included. These potential atmospheric effects are illustrated in Figure 3.

Estimates of the local and mesoscale weather and climate effects of waste heat from an SPS rectenna indicate that impacts would generally be small, but would be detectable in some instances. The absorption of microwave power in the troposphere is expected to be worse during rain storms, but even then would have a negligible effect on the weather.

An assessment of the air quality impacts of the HLLV, if launched from Kennedy Space Center has shown that:

- The sulfur dioxide concentration would not be a critical problem.
- Nearly all of the carbon monoxide would be oxidized to carbon dioxide.
- The amount of nitric oxide formed would probably be negligible.
- Acid rain might occur near the launch site if sulfur was present in significant quantities in the fuel. Nitrogen is also a potential source for the formation of acid rain but thus far this possibility has not been evaluated.

Valuable but limited information has been gathered regarding inadvertent weather modification due to rocket launches. Because there

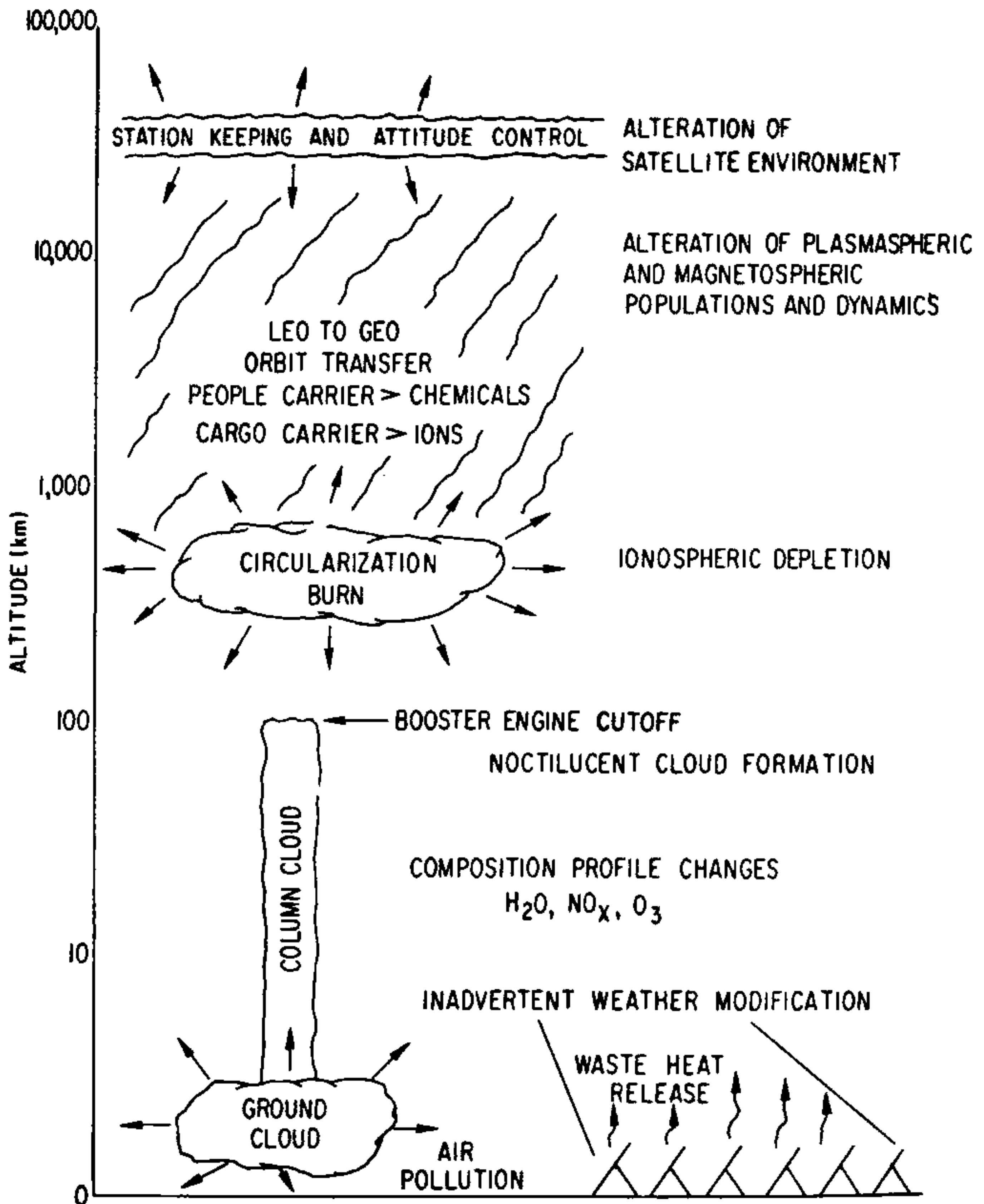

Fig. 3. Illustration of Potential SSP Atmospheric Effects

is a possibility for inadvertent weather modification by the SPS rocket effluents in the troposphere and because cumulative effects would be possible, continuing monitoring of rocket-exhaust ground clouds is needed. Simulations (using computer models) of inadvertent weather modification by HLLV launches under various meteorological conditions are also required to improve the assessment.

Carbon dioxide emissions due to rocket launches would be expected to have no detectable effect in the stratosphere and mesosphere. However, water vapor concentrations could be increased by SPS-related rocket-exhaust emissions. The change in the total (globally averaged) ozone layer due to SPS spaceflights would be expected to be undetectable, as would the effects of nitrogen oxides. The presence of a 0.05% sulfur impurity in the fuel is not considered likely to have any impact, and a similar conclusion may be reached regarding other fuel impurities. Corridor-effect calculations are important to an improved assessment of the SPS perturbations of the composition of the stratosphere and mesosphere.

The globally averaged effect, on the earth's surface, of the anticipated composition perturbation in the stratosphere and mesosphere would be negligible. Reliable assessments of general climatic effects due to SPS perturbations must await model predictions of altitude and latitude dependence. It is probable that transient clouds at stratosphere and mesosphere altitudes would be induced in the vicinity of the launch site but they would not be expected to have a detectable impact on anything else.

The lowest layers of the ionosphere (the D- and E-regions) could be affected by both rocket launches and spacecraft reentry. The effluents from these space operations include water vapor, hydrogen gas, and thermal energy during launch, and ablated materials, oxides of nitrogen, and thermal energy during reentry. These effluents would modify the composition and properties of the ionosphere and might influence climate, satellite-based surveillance systems, radio communications, navigation systems, microwave propagation (SPS power-beam stability) and magnetospheric processes. While the likelihood of altering the electron and ion composition seems to be fairly high, the magnitude of the impacts is uncertain. The effects of nitrogen oxides formed during reentry and the effects of ablated materials do not appear to be important at this time.

Calculations have shown that injection of water and carbon dioxide into the F-region of the ionosphere results in both plasma reduction (electron-ion recombination) and enhanced airglow (visible and IR emissions from excited molecules). These predictions have been verified both inadvertently during the Skylab launch and deliberately during the Lagopedo experiments. Plasma reductions can result in interference with radio communications and navigation systems. Enhanced airglow, while not a serious matter at ground level, can contribute to the noise level of satellite-based surveillance systems.

The issues associated with SPS rocket effluents in the plasmasphere and magnetosphere include the following:

- Injection of Ar⁺ ions. Effects would be likely and would be expected to be important.
- Generation of plasma instabilities. Possibility of communication interference is unknown.
- Enhancement of airglow. Probability of occurrence and severity of impacts are unknown.
- Disturbance of Van Allen belts and plasma sheet. Probability of occurrence is unknown but potential impacts are important.
- Changes in auroral current systems. Probability of occurrence and severity of impact are unknown.
- Magnetosphere/solar-wind interaction changes. Effects are uncertain but may be important if associated with climate.

EFFECTS OF IONOSPHERIC DISTURBANCE ON TELECOMMUNICATIONS

The ionosphere is the part of the earth's atmosphere beginning at an altitude of about 50 kilometers and extending outward 400 kilometers or more, containing free electrically-charged particles (electrons and ions). The characteristics of the ionosphere vary daily, seasonally, and with the solar cycle.

The ionosphere refracts (deflects) and slows down electromagnetic energy (such as radio waves). The amount of deflection depends on ionospheric electron density, the wave frequency of the electromagnetic energy, the frequency of occurrence of electron collisions, and the strength of the geomagnetic field. The electron density can cause a radio wave to be totally reflected and returned to the earth's surface. This property is used for long-distance propagation of high-frequency radio waves. Radio waves at higher frequencies travel directly through the ionosphere.

Changes in the ionosphere can alter the performance of telecommunication systems whose power is transmitted within and through the ionosphere. Small-scale irregularities (meter to kilometers) in ionospheric electron density can produce radio signal fading and result in loss of information. Ionospheric changes due to the SPS Reference System could result either from interactions between the ionosphere and the SPS microwave beam (heating) or interactions with effluents from SPS space vehicles.

The microwave power density transmitted from solar power satellites to earth might be sufficient to heat the ionosphere, even though only a

small fraction of the microwave power would be absorbed by the ionosphere. The heating mechanism is complex, resulting in phenomena such as increased electron temperatures, irregularities in electron density, and focusing of electromagnetic waves. The communications effects of such heating might include absorption or scattering of radio waves (which would disrupt communications systems depending upon the ionosphere as a signal propagation path) and scattering of both the SPS microwave power beam transmitted from space and the beam control signal sent from rectenna to power satellite. Figure 4 illustrates examples of SPS microwave transmission effects on the ionosphere and telecommunications systems.

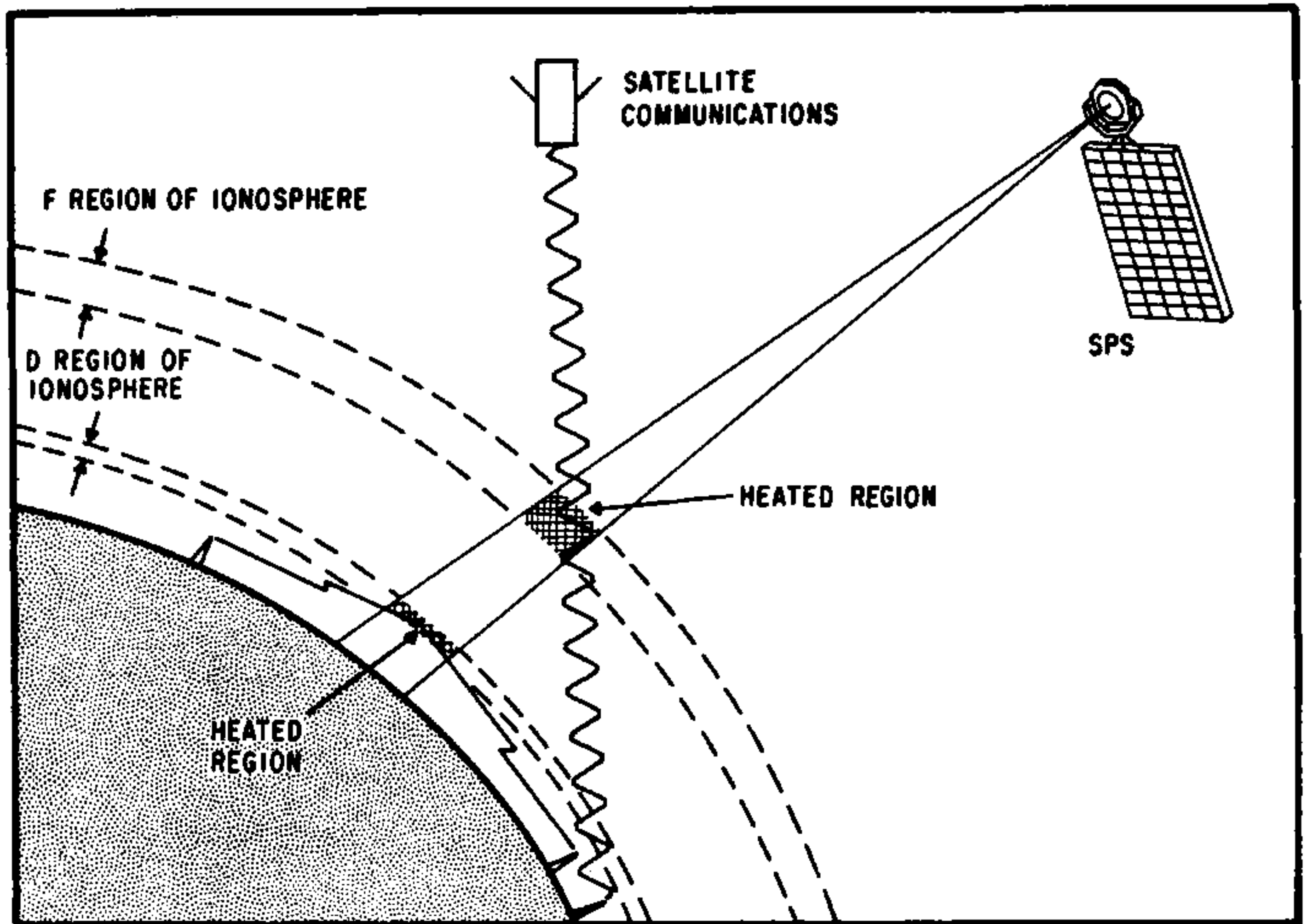

Fig. 4. Examples of SPS Microwave Transmission Effects on the Ionosphere and Telecommunication Systems

A coordinated program of theoretical and experimental work is underway to better understand the impact of SPS heating of the ionosphere. Experimental studies are performed at Arecibo Observatory in Puerto Rico and the Ionospheric Heater Facility in Platteville, Colorado. Both facilities use high-frequency radio-wave transmissions to heat the ionosphere; they can deposit power in the lower ionosphere that is

equivalent to the SPS power for ionospheric heating. This is possible because the heating is inversely proportional to the square of the heater frequency.

Experiments related to SPS effects on telecommunications have been conducted at Platteville, where the communications environment is representative of environments in which the SPS microwave-beam transmission would typically occur. Many different types of communications signals are monitored while the Platteville facility is heating the ionosphere. Because the current Platteville facility provides SPS comparable power density only to the lower ionosphere, the telecommunications experiments performed so far were directed toward obtaining performance information for those systems whose radio waves are significantly affected by the structure of the lower ionosphere. The telecommunication systems chosen for investigation were representative of those operating in the very low frequency (VLF, 3 kHz-30 kHz), low frequency (LF, 30 kHz-300 kHz), and medium frequency (MF, 300 kHz-3 MHz) portions of the electromagnetic spectrum. The results obtained indicate that the SPS, as currently configured with a peak power density of 23 mW/cm², will not adversely impact upon the performance of VLF, LF, and MF telecommunication systems.

The currently available ionospheric heater facilities are limited in power and frequency range and cannot simulate SPS effects in the upper ionosphere. Modified and expanded facilities would be required to simulate SPS heating of the upper ionosphere, verify the frequency scaling theories, and study the limitations on power density in the ionosphere.

The electron density of the ionosphere likely would be decreased by rocket effluents in the vicinity of the SPS launch sites creating "ionospheric holes." Theoretical predictions of electron depletion and data from Skylab and missile launches suggest that a wide range of communications services could be affected following SPS rocket launches.

ELECTROMAGNETIC COMPATIBILITY

Electromagnetic compatibility is achieved when the capabilities of radio, radar, and other electronic systems are maximized with a minimum of interference between systems. The satellite power system would be designed and operated in ways which would satisfy established national and international rules for using the electromagnetic spectrum. Nevertheless, there would be a potential for producing interference because the amount of microwave power transmitted from space to earth for the Reference System would be unprecedented, and the size of the microwave beam would be very large at the earth's surface.

The SPS field intensity would be one volt per meter at a distance of 30 kilometers from the center of a rectenna site. Communications systems generally operate with received-signal strengths of several microvolts per meter so communications systems within about 100 kilometers of an SPS rectenna could receive sizable signals from the satellite

power system. Commercial radio and television signals at distances of 1 to 50 kilometers from the transmitter range from several millivolts to several microvolts.

Examples of SPS microwave transmission beam interference mechanisms are illustrated in Figure 5. Electromagnetic systems likely to experience SPS interference would include military systems, public communications, radar, aircraft communications, public utility and transportation system communications, other satellites, and radio and optical astronomy. The interference potential of the SPS would not be especially unusual except in terms of geographic area. Many high-powered radar systems can produce interference of similar electromagnetic intensities, but the influence is generally limited to the immediate geographic area. Mitigating strategies such as cabinet shielding and radio receiver filters are commonly used to avoid interference near radar stations, and these strategies could be adapted, to at least some extent, if interference situations were encountered with the satellite power systems. Equitable distribution of the costs of such strategies would require careful attention.

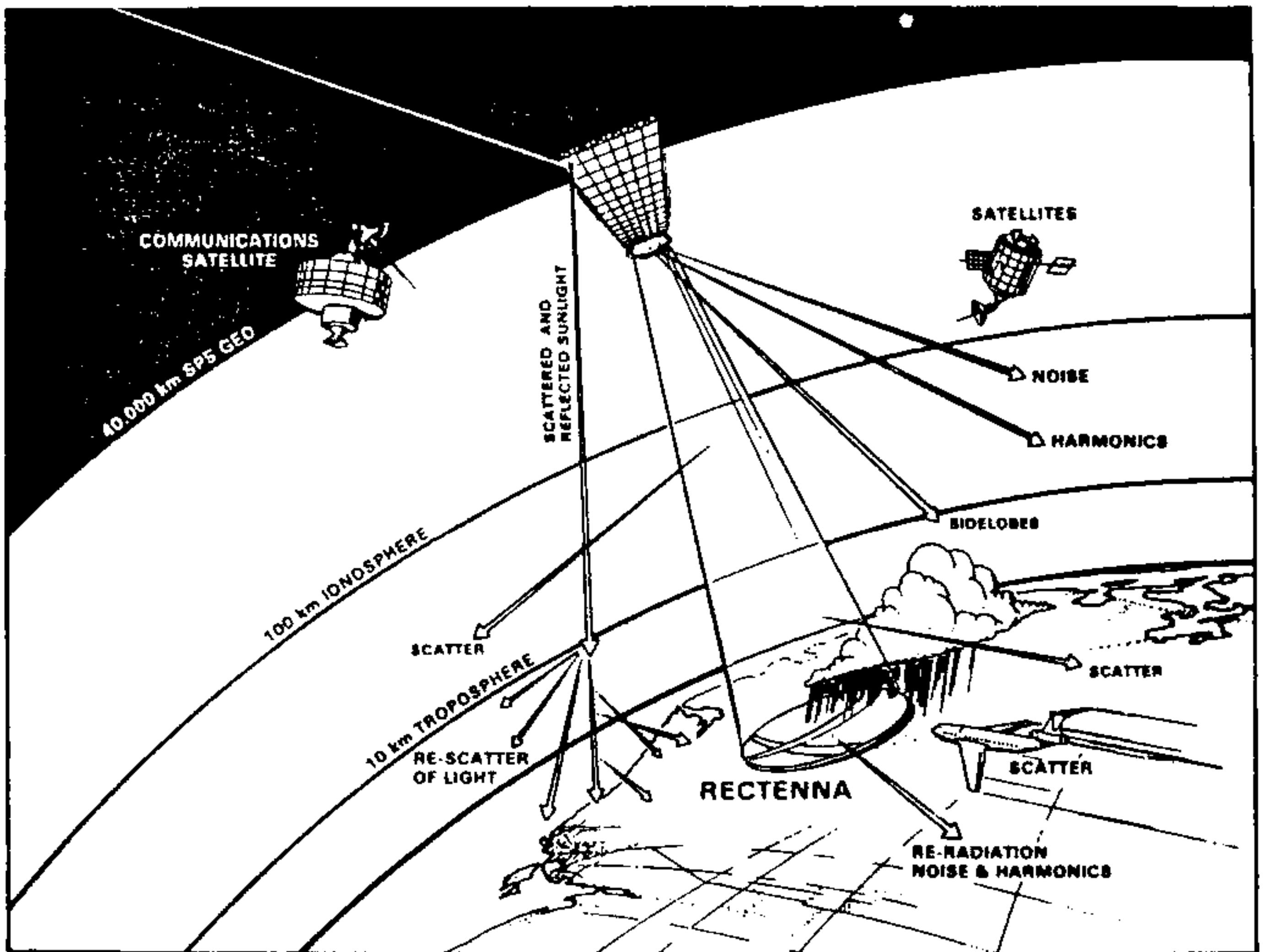

Fig. 5. SPS Electromagnetic Interference Mechanisms

The principal mitigation strategy for preventing SPS interference by direct energy coupling to any class of equipment is a part of the engineering design of the solar power satellite and the rectenna. Interference can be minimized by designing the SPS microwave system to stringent specifications, thereby reducing undesirable emissions at frequencies other than its operating frequency and constraining the size and shape of the transmitted microwave beam. Judicious rectenna siting--including rational tradeoffs between the desire to locate rectennas as near to energy load centers as practical and the need to avoid interference with the maximum number of other users of the radio spectrum--also is an important mitigation strategy.

Military communications equipment is generally complex; uses especially low operating signal levels and therefore is particularly sensitive to electromagnetic interference. Possibilities for modifying the equipment to reduce interference are limited by the nature of its uses. A study has been completed that characterized the potential for SPS interference if a rectenna were located near a large military facility. The China Lake Naval Test Center and two Air Force bases in the Mojave Desert in Southern California were selected for the study. The site selected was especially useful because a wide range of civil telecommunications systems is located nearby and a major electric load center (Los Angeles) is some distance west of the Test Center. Thus the site may be regarded as potentially typical of an actual SPS rectenna site insofar as it conforms to several basic criteria (infrequent cloud cover, near a load center, low population density in the immediate vicinity, etc.). At least 813 government and 685 civil systems were on record as located in a 21,000 square-kilometer area surrounding the hypothetical rectenna and were analyzed.

The study showed there would be a significant potential for the satellite power system to interfere with national defense requirements as represented by large military operational, test, and evaluation facilities. The performance of radar instruments used at airstrips and on test ranges to acquire and track targets might be degraded by 10 to 65 percent. The reception and reliability of command and control communications could be reduced to 5 to 30 percent, and tactical systems performance could be reduced greatly.

Recognizing the constraints inherent in ameliorating interference involving military equipment, the sole mitigation strategy considered in the study was changing the location of the hypothetical SPS rectenna. A relatively minor change in location substantially reduced the impact on national defense facilities without increasing interference effects on civil systems. This scheme may be applicable in other places where large, essentially unoccupied land areas are potentially available as rectenna sites but may be of limited value because of nearby military and civil electromagnetic systems.

Geosynchronous earth orbit (GEO) is currently occupied by a number of space satellites, and undoubtedly will be occupied by others in the

future. The SPS also would be located at GEO altitudes. The U.S. INTELSAT satellite has been analyzed as a "worst case" example of potential SPS interference with other GEO satellites. The microwave power which could be delivered to INTELSAT by a solar power satellite was computed and compared with the calculated interference threshold for INTELSAT. The comparison showed that, under maximum-interference conditions, the power delivered by the power satellite would be more than five times lower than that required for interference to occur. Interference thresholds for other commercial GEO satellites are similar to that for INTELSAT, so it can be inferred that the SPS would not be likely to interfere with commercial satellites in GEO. Military satellites are now being analyzed.

Low earth orbit also is occupied by satellites, such as LANDSAT, which is used to monitor earth resources management, and GPS, which is used as a global navigation and position-fixing system. LANDSAT traverses the continental United States six to eight times each day, so it conceivably could encounter an SPS microwave beam. The transit time through the beam would be approximately four seconds; sensor and communications interference could occur during transit. Modifications to the resource satellite to prevent interference appear to be feasible. The GPS satellite is in a higher orbit than LANDSAT and therefore would be exposed to more intense SPS electromagnetic energy and consequently would experience more severe interference. Mitigation strategies are currently being studied for GPS.

Both radio and optical astronomy are used to study the weakest measurable sky signals. Since the satellite power system would contribute power to the radio, infrared, and optical spectrums, there would be significant potential for limiting capabilities for astronomical observations. Radioastronomy could be affected by SPS microwave power beams at distances of hundreds of kilometers from rectenna sites. Additional studies are required to develop a quantitative assessment of these effects.

Power satellites in space would be expected to reflect substantial amounts of light. Even with a coefficient of reflectivity as low as four percent, each power satellite would appear to be brighter than all but the brightest bodies in the sky (the sun and the moon) and would be about as bright as Venus when it is most visible. Multiple satellites would brighten the sky considerably. For example, 60 satellites would provide as much light as the moon between its new and quarter phases across a band 40° long and 10° wide. Earth-based optical observations would be hindered under these conditions.

REFERENCES

1. *Satellite Power System Concept Development and Evaluation Program Reference System Report*, Department of Energy Report DOE/ER-0023 (October 1978).

2. *Preliminary Environmental Assessment for the Satellite Power System (SPS) Revision 1, Volume 1 - Executive Summary; Volume 2 - Detailed Assessment*, Department of Energy Reports DOE/ER-0036/1 and DOE/ER-0036/2 (January 1980).
3. R. A. Tell and E. D. Mantiplay, "Population Exposure to VHF and UHF Broadcast Radiation in the United States," *Proc. IEEE*, 68(1):6-12 (January 1980).

SOCIETAL ASSESSMENT OVERVIEW

Charles E. Bloomquist
PRC Systems Sciences Company

The decision to proceed with SPS will depend on a political determination that commitment of the economic, institutional, and social energies required for its implementation is a worthwhile investment. This determination will be national (and international) in scope and will be based on knowledge of the environmental and societal impacts of the SPS, its projected economics and technological risks, expressed through the influence of contending segments of society.

To assist the decision makers, an assessment of societal issues associated with the SPS has been undertaken as part of the Concept Development and Evaluation Program. Results of the assessment are reported here.

The primary societal assessment objectives are:

- (1) to determine if the societal ramifications of an SPS might significantly impede its development, and
- (2) to establish an information base regarding these issues.

The approach taken to meet these objectives is oriented to serve the needs of the decision makers. That is, the studies conducted are not intended to be exhaustive treatments of the issues addressed; rather, they are to provide estimates regarding SPS impacts commensurate with its stage of development and the needs of the decision makers.

The four major areas of the societal assessment are: Resources, Institutional Issues, International Implications, and Public Concerns. The rationale for dividing the assessment into these categories is somewhat as follows. Societal issues are created by the interplay between the SPS and its external environment. Those components of the external environment which clearly exert control or influence over SPS and those which are most directly impacted by SPS were given primary considerations.

The SPS requires large inputs of resources, the allocation of which depends on various decision making bodies or institutions. Other institutional mechanisms are required to manage program activities and control interfaces between the SPS and its external environment. International bodies would exert control over SPS because of financial interest, its space-based nature, and the need for agreements to allocate radio frequencies and orbital slots and to set microwave exposure standards. Because of its global significance, the SPS would, in turn, influence international relations. Public concerns over potential social change resulting from the magnitude of the program and the interplay of environmental institutional and international mechanisms is one of the most important components of the external environment.

Having defined the general areas of concern, a two-phase study process was implemented. Key issues in each area were defined and a preliminary assessment was conducted. On the basis of the results, a final assessment was undertaken to pursue the preliminary studies further, where indicated, or to undertake new initiatives which seemed to be indicated. The end result of this process is over two dozen issue-related study reports in addition to a preliminary and

final societal assessment report which attempt to compile the key findings and their implication for SPS. The findings are briefly surveyed below by issue area.

Resources

Based on an initial understanding of system characteristics, the physical resource requirements most likely to present a potential problem were considered to be land, materials, and energy. Therefore, a preliminary study was commissioned to assess the magnitude and impact of these SPS resource requirements. Since determination of land requirements alone is not as important as knowing where rectenna sites can be located, a second study was conducted to identify locational criteria and make a preliminary determination of areas that were eligible for rectenna sites. On the basis of the preliminary studies, three additional activities were undertaken in the final assessment. First, a general methodology for materials assessment of energy systems was refined and applied to the SPS situation to validate and extend the preliminary findings. Preliminary work in the analysis of energy utilization by SPS indicated that no further work was warranted in this area. The preliminary siting and land-use studies, however, indicated the need for a more sophisticated approach to this problem. Two additional studies were, therefore, set in motion. The first of these was essentially a follow-on to the preliminary work in finding eligible and ineligible areas for rectenna sites. The second examined a specific site in great detail to determine the potential environmental impact of installing an SPS rectenna there. These studies are all essentially complete; results are briefly indicated in the following paragraphs.

The preliminary materials analysis compiled a list of required materials for an SPS and then, using a relatively crude screening procedure, evaluated each material in terms of world and domestic supply. Also considered were manufacturing capacity and adequacy of the data base. The refined methodology uses computerized screening of the materials with flags raised at various threshold levels as a function of several parameters: current domestic and world production rates, domestic and world reserves, and so on. Thresholds can be changed and the analysis rapidly run to determine sensitivities. No insurmountable materials problems are evident in either the preliminary or refined analysis. However, materials definition, both quantities and specific kinds, is in a fairly primitive state. Similar analyses will be required as the detailed materials requirements become better defined. Currently, well over half of the elements or compounds required by either design option (silicon or gallium arsenide for the photovoltaic cell material) present no problems. There is a problem in the demand for mercury and tungsten in both options, with silver and gallium becoming problems for the gallium arsenide option. Manufacturing capacity problems are also judged to be more severe for the gallium arsenide option.

Net energy analysis has been used in the past to compare alternative energy generating systems in terms of the energy produced by each system per unit of energy required. The preliminary assessment indicated that there have been a few analyses of the SPS using some of the widely varying techniques

available. SPS energy ratios were found to be marginally favorable with respect to other energy sources when the system boundaries were drawn so as to exclude fuel ("fuel" in this case being solar radiation). When fuel is included, the SPS energy ratios are very favorable. There are, however, large uncertainties associated with the SPS design and with the energy analysis techniques themselves. Because of these uncertainties, it was considered unwarranted to conduct additional studies in this area for the final assessment. If further studies should be undertaken in the future, it is recommended that such analysis employ a hybrid methodology consisting of: (1) process analysis to identify key initial energy requirements, and, (2) input-output analysis to account for indirect energies. A breakdown of material requirements by system component would facilitate the use of materials energy intensity data and better reveal sensitivity to data uncertainties in the energy analysis. Basically, the energy resource is not considered to be a problem. However, the high initial energy investments of a capital-intensive SPS program make for a long pay-off period. The dynamic consequence of the program mean that, though each individual plant may have a positive energy ratio, initial energy requirements create a protracted energy drain during the initial years of construction and operation.

The approach to the land-use problem, both in the preliminary and final assessments, has been to identify those areas of the contiguous United States that cannot be used for siting rectennas. The remaining areas are then "eligible," pending further analysis. It has also been assumed in both assessments that the required land must be near enough to load centers to represent a reasonable solution to the utility integration problem. Thus, sufficient land is only one requirement; suitably located land is another. The preliminary assessment identified areas of the U.S. that were potentially eligible for SPS rectenna sites. A problem arose, however, in matching potentially eligible areas to power demand areas. The North Central and Northeast regions of the U.S. have the smallest potential area for rectenna siting relative to apparent need. Unfortunately, the uncertainties in the analysis were such that little confidence could be placed in these results. Therefore, a follow-on study was undertaken that refined the data base of exclusion criteria (populated areas, national parks, etc.) and used a finer mapping grid in the eligible area analysis. The preliminary assessment used a 26 X 26 kilometer grid size; the final assessment used the USCG 7.5 minute quad maps which are roughly 13 kilometers on a side. Validation of both eligible and ineligible areas was incorporated in the analysis and sensitivity studies were conducted. In a related but independent analysis, a prototype environmental impact statement was prepared for a specific, although hypothetical rectenna site.

The primary conclusions of the siting studies are that there are suitably located areas for rectenna sites throughout the U.S. Actual acquisition of the specific sites promises to be a difficult problem at best, and location of sites in some of these areas will exact a fairly heavy cost penalty to either prepare the site or modify the rectenna design. The most critical design variable is topography. Sites can be placed in different terrain but only at a substantial cost penalty incurred in site preparation. Migratory bird flyways could have a devastating impact on eligible areas, depending on the (currently unknown) impact of SPS microwave radiation on birds. Sea sites are

available but definition of eligibility is necessarily more crude due to the lack of design parameters for an offshore rectenna. The methodology for determining eligible areas for SPS rectenna sites is highly automated, elegant, and widely applicable.

The prototype environmental impact statement was prepared to see what problems would be uncovered by taking a detailed look at a specific site. The location was chosen because a nearly concurrent EIS was being prepared for the site as a potential location for a geothermal energy resource. Thus, the massive amounts of required background data were essentially free and it was only necessary to hypothesize the placement of a rectenna in the area and redo the analysis. Objectives of the study were: (1) to develop a comprehensive prototype assessment of the non-microwave-related impacts, (2) to assess the impacts of rectenna construction and operations in the context of actual baseline data for a site in the California desert about 250 kilometers north of Los Angeles, and (3) to identify critical rectenna characteristics that are most significant in terms of the natural and human environment. Critical characteristics include: the sheer size and intensity of use of the contiguous land area required by an SPS rectenna; the lack of flexibility in siting individual rectenna structures once the rectenna boundaries are established; the difficulty in finding suitable sites that do not conflict with other societal needs and values; uncertainties relating to reestablishing native ecosystems following total ecosystem modification during construction, and the related need for further research into microclimatic effects near the ground surface beneath the rectenna panels; the proposed two-year construction schedule which has significant implications for socioeconomic impacts, air quality, water supply, and biological resources--all of which could be reduced by extending the construction schedule; and public versus private ownership which has significant implications for rectenna impacts on the local tax base.

Institutional Issues

Initial concerns in this area focused on the financing and management of a system as large as SPS, its anticipated difficulties with state and local regulations and its interface with the existing utility industry in the U.S. The utility interface studies were continued in the final assessment period to more definitely explore this critical parameter. The regulation of microwave radiation is in a state of flux and is extremely important for all implementation schemes of SPS which rely on transmission of power by microwave radiation. Therefore, a detailed study was undertaken to establish the state-of-the-art, historical background, and likely future of the regulation of microwave radiation. A survey of federal agency involvement in general for future phases of SPS development was established to assist in program management and perhaps to form the basis for future interagency involvement. The insurability of SPS was investigated by a major broker of spacecraft insurance to get an initial feeling of the special problems involved with respect to SPS and the probable response of the insurance community. Results of these studies are indicated in the following paragraphs.

The financial attractiveness of any project depends on the relationship between anticipated rewards and expected risks. In the case of the SPS, potential problems or downside risk plays a major role in project financing. Risk can be measured through cash flow scenarios or in terms of pay-off periods. The busbar cost of electricity is found to be the single most important factor in cash flow and rate of return. The large capital requirements for SPS through R&D and the initial operational phases tend to favor some form of public sector financing. The federal government or a consortium of governments may be the only available source of financing during start-up operations. Even when the SPS reaches maturity, the private sector would face an extreme challenge to finance the program. A joint venture partnership between government and the private sector is possible where the public interest would be assured by regulation of prices and profits, and government license of the technology. Just how government regulation and the private sector would interface with the SPS requires greater clarification, especially as it regards electricity pricing, industrial relocation, and private sector financing.

Power plant regulation falls primarily under the jurisdictional review of state and local entities. The regulatory framework is in a state of flux, and processes vary by jurisdiction. The role of state Public Utility Commissions in financing and rate regulation is changing. PUCs' approvals of utilities' pre-commitment to the SPS may be conditional on government guarantees regarding electric power pricing. In lieu of the federal government's establishment of a national energy policy, many states are going their own way, creating a de facto decentralized trend in energy policy. States want and are asserting increasing control over power plant planning. This poses a potential problem for the SPS. The inherent characteristics of the SPS will require regional coordination of power plant regulation and transmission interties. No present regulatory framework exists at interstate levels. Land-intensive rectennas may require federally mandated, state-coordinated land use and energy planning. The establishment of a national power grid, currently under study at the federal level, may alleviate or solve many of these problems. Regulatory approvals for current power plant technologies and other delays in regulatory processes now consume a decade or more. This is an indication of the potential time constraints in developing and operating the SPS.

Two categories of concern have been studied with respect to integrating SPS electricity with the then existing utilities. The first has concentrated on questions of ownership, management and other institutional factors remains from the utilities' point of view. The resolution of these factors remains rather nebulous because of the difficulty of predicting future situations. It is fairly clear, however, that while the SPS could be integrated into projected utility networks, the task will not be easy. Technical considerations regarding the location of rectenna sites across the U.S. and providing power to land centers appears to present no great difficulty even under rather severe constraints. There are regional differences but even these are less than might have been anticipated.

There are no federal standards which exist protecting the worker and/or general public from potential hazards of microwave exposure. "Voluntary"

guidelines of 10 mW/cm^2 are a recommended set of values established by the American National Standards Institute (ANSI) in 1966. Events from as early as the 1930's, stimulated by research on "nonthermal" effects of rf radiation as a therapeutic technique, are the roots of the ANSI standard. Currently the lead federal agencies with regulatory responsibilities for microwave radiation are the Department of Health, Education and Welfare (HEW), the Department of Labor (DOL), and Environmental Protection Agency (EPA). Each of these agencies contains specialized subsidiary offices, research, or advisory bureaus to assist a respective agency in establishing and enforcing microwave regulations. The entire federal regulatory process is currently under review, aimed at streamlining and improving the system. Proposed changes include a Committee on Regulatory Evaluation to oversee the regulatory efforts of all agencies. The regulatory changes would also require each new ruling with an economic impact of more than \$100 million to consider alternatives to the ruling, including projected costs and benefits of the proposal. For SPS, these regulatory changes would demand an assessment of microwave health effects and a cost and benefit analysis of SPS-derived energy weighed against not having enough energy in the absence of SPS, or any other energy-producing concept. In general, there is a growing trend toward stricter controls on activities perceived harmful to public health. There is also a trend toward the convergence of microwave standards worldwide, characterized by a lowering of Western exposure levels while Eastern countries consider standard relaxation. Cooperative exchange programs and an increasing dialogue between countries and scientists have contributed to a better understanding of methodology and experimental techniques used to develop standards. The need for additional bioeffects research is central to adopting public and workplace standards. Of particular relevance to SPS is the initiation of long-term, low-level microwave exposure programs. Coupled with new developments in instrumentation and dosimetry, the results from chronic exposure programs and population exposure programs and population exposure studies could be expected within the next five to ten years. Public interest in microwave radiation is on the increase. Public concern that rf energy is yet another hazardous environmental agent is sparked by increasing media attention to the topic. In the absence of definitive scientific data on electromagnetic bioeffects, both thermal and nonthermal, discussions of utilizing microwaves may engender all the rhetoric, pro and con, which surrounds the implementation of nuclear power.

Agencies with a purview over the Satellite Power System have been identified including the scope of their responsibility and when and how they can be expected to exercise their authority. The materials are presented in a workbook format. The identification of agencies was accomplished by calling out major SPS functions and activities within the five remaining phases and also within the major issue areas. This list of functions addresses an SPS of international nature as well as one that is limited to a national focus. In either scenario, most of the regulatory functions would continue to be applicable to SPS construction and operation within the United States, but the roles of some agencies, such as the Department of State, would increase dramatically in the international scenario. The SPS concept poses many exposures to both financial loss and liability to third parties. In order to eliminate or minimize these exposures, it is possible that insurance could be provided

to protect against certain risks during both pre-operational and operational phases. The international underwriting community has shown a willingness to insure the sizeable risks affiliated with today's telecommunications satellites, and this precedent could serve as a basis for the acceptance of SPS ground and space-related exposures. The major risks affiliated with the program stem from both the sizeable financial losses that could be incurred and the enormous liability exposures presented by extensive launch and space-construction activities. The possible environmental effects of both the ground and space segments also present a substantial degree of risk. The interrelation of so many participants combined with the need for a continuous flow of resources into space and to launch/rectenna sites forms a dynamic system that can be severely damaged by catastrophic loss at a number of key points. The effects of the overall SPS effort, moreover, will extend into an international realm that today does not provide for the sharing of liability exposures among what could be a consortium of many diverse countries. Even if constructed as a domestic effort, the exposure to international lawsuits are not clear at this time. Underwriters do not presently have a basis for assessing either the possible origins of claims or their severity. However, an effort to develop SPS, combined with a close liaison with the world insurance market, would undoubtedly result in insurance for many SPS exposures. A consistent educational process will both allow underwriters to identify periods of exposure, for which policies could be designed, and would allow increased market capacity for these risks to achieve required levels.

International Considerations

The preliminary assessment identified three important international considerations with respect to SPS. These are: (1) controls expected to be exercised by international organizations through enforcement of treaties governing operations in space and new agreements (e.g., on microwave radiation, geostationary orbit and radio frequency assignment) that may be required because of unique aspects of the SPS; (2) international organizational options to successfully manage the SPS; and (3) military implications of the SPS. A final assessment of the military implications of the SPS was undertaken to more specifically address threats and undertaken by SPS subsystem. In addition, the final assessment has drawn together previously contracted work, melded in foreign appraisals of the SPS, assessed the current international status of SPS, developed strategy guidelines based on case studies of existing international organizations, and derived this from options for an international dialogue within the context of world political/legal realities and agency concerns.

An international organization is strongly indicated for SPS development and commercialization. Four prospective international organizational structure models for the SPS are: (a) a public/private corporation akin to COMSAT, which would evolve into an international corporation akin to INTELSAT; (b) an international organization in which the U.S. would retain substantial control; (c) a quasi-governmental agency like the TVA; (d) a multi-national, private consortium. Any SPS organization must be: responsive to U.S. energy needs, politically feasible, cost-effective, and conducive to international

cooperation and acceptability. The COMSAT/INTELSAT option meets these four conditions. The international scope of the SPS, however, may be better obtained by selling SPS hardware (i.e., satellites, rectennas, etc.) rather than the power, because foreign participants would have a greater stake in the venture than if they were merely passive consumers.

Extensive treaty provisions would be required in order to realize an internationally acceptable SPS. Three existing international organizations most directly concerned with SPS are the: (a) U.N. Committee on the Peaceful Uses of Outer Space (UNCOPUOS), (b) International Telecommunications Union (ITU), (c) Committee on Space Research (COSPAR) of the International Council of Scientific Unions (ICSU). The three existing treaties most applicable to the SPS are the: (a) 1967 Treaty on Principles Governing the Activities of States in the Exploration and Use of Outer Space, Including the Moon and Other Celestial Bodies (U.N.), (b) 1972 Convention on International Liability and Damage Caused by Space Objects (U.N.), (c) 1973 Telecommunications Convention and Final Protocol Treaty. Under the 1967 Principles Treaty, the space environment is considered to be open to all who are able to use it. In the case of the SPS, the consideration of space and its environs as part of the "common heritage of mankind" raises the question as to who should benefit from the space resource. The radio frequency spectrum and the geostationary orbit are considered natural resources. As such, they fall within the "province of mankind" pursuant to the 1967 Principles Treaty. The seemingly finite geostationary orbit space and increasing competition for its use will influence slot availability for the SPS. Some nations argue that long-term use of geostationary orbit slot is the same as appropriating it and is, therefore, in violation of the treaty. However, there is some consensus on the first come, first served principle. States with space capabilities have clearly established a customary rule of law whereby outer space exists beyond the sovereignty of any nation-state. This rule has been established in the absence of a formal definition of outer space sovereignty and in the face of the Bogota Declaration, issued by eight equatorial countries asserting sovereignty over the geostationary orbit above their land mass. While international law has not established microwave exposure standards, the 1972 Liability Convention covers the subject of harm caused by orbiting space objects. The Convention is "victim oriented." Clearly, a launching State would be internationally liable for harm produced by microwave radiation emanating from a space object in geostationary orbit. International law prohibits adverse changes in the environment. There is a present lack of knowledge about microwave health and environmental effects. International agreement on microwave exposure standards may be reached much faster if a framework of cooperative bilateral agreements has been established between the U.S. and other countries. The U.S., or any organization operating the SPS, must have general international acceptance of microwave exposure standards in order to be safe from potential negligence suits. The U.S. could take a positive role in calling for an international pool of resources to help in assessing the feasibility, benefits, and impediments of developing a satellite power system. Participation by all countries in such a scheme and distribution of eventual benefits could be determined solely, or in part, on the basis of contributions of human and material resources. It would appear to be more than just a reflection of enlightened

self-interest to spread the R&D costs among the nations of the world. Such policy would further undercut any argument by equatorial countries that the current system is inequitable because the benefits of outer space industrialization would accrue to both space and non-space powers.

The huge power supply that the SPS would develop and the strategic position of the geostationary orbit make the system attractive for some military applications and also vulnerable to attack. Thus, militarily, the SPS becomes a factor in international relations. One has to distinguish between aggressive and supportive military applications to properly assess the impact. There are potential weapons capabilities which would accommodate SPS power output. The SPS could also be used to relay power to other military installations (such as satellites, aircraft, or remote terrestrial stations) or to function as a platform in a manned or unmanned mode for surveillance, repair, etc. Whether or not the SPS serves a military function, it would be attractive as a target. The space segment of the SPS would be vulnerable to an energy with space capabilities but relatively invulnerable to saboteurs or terrorists. The ground segment of the SPS would pose no more attractive a target to saboteurs, terrorists or military attack than other major industrial complexes. However, since the rectenna site would control its assigned satellite to some degree, strong protective measures are indicated. An SPS with offensive or defensive capabilities would have an unsettling impact on international relations. International agreements including resident inspection teams at the satellites would probably be required to minimize vulnerability, and ensure the non-militarization of the SPS.

The possible benefits of an SPS program are not just national in scope. It is an inherently international energy concept in that it would utilize resources that are within the international domain (e.g., outer space and the radio frequency spectrum) and would have some impact on the global environment. In this sense foreign involvement is inevitable. But beyond this, the energy potential of the SPS is global in nature. International participation in its development would enhance this potential and contribute to the improvement of international relations. A strategy for international participation in the SPS program has been prepared by (1) assessing the current international status of the SPS in terms of foreign interests, programs and recommendations; (2) integrating the findings of previous investigators who have worked on international SPS issues; (3) developing strategy guidelines based on case studies of existing, large international organizations; and, (4) putting all this information together to develop options within the context of world political/legal climate and agency concerns.

Public Concerns

The preliminary assessment of public concerns focused on two specific and two general issues. The specific issues were relocation and centralization/decentralization. The general issues were public acceptance and student participation. The general studies were intended to develop preliminary public perspectives on the acceptability of the SPS concept and to develop methods for disseminating SPS information to the college community. The issue of centralization is an important topic for investigation on the basis that: (a) there

may be a dichotomy between the SPS design concept and public preferences, and (b) the magnitude of the power output relative to present power-generation facilities have potentially wide sociological ramifications. Implementation of other large energy generation schemes has caused severe relocation of industry and populations. Thus, the preliminary assessment included treatment of this issue from the SPS perspective. The final assessment continued studies of public acceptability, considered the specific problems of the aged and conducted a public outreach experiment, including three public interest groups and thousands of individuals. All studies in this area were summarized in a document which also explored strategy options for the further involvement of the public in the unfolding SPS development process.

The development of a national awareness of the possible environmental impacts of large-scale projects; passage of various laws and regulations for the purpose of controlling environmental degradation; mandatory direct public involvement in project review and approval; and the rise to prominence of public interest organizations have all made the consideration of public acceptability of the SPS very important. Because of the preliminary nature of the SPS concept development and evaluation and the lack of evidence to show any more than a minimal level of public awareness about the SPS, the investigative reports on public acceptance put most of their emphasis on the more general, pre-siting-related issues and the views of knowledgeable organized interests, expressed in the media through personal communication. SPS is not viewed as a highly acceptable energy alternative at this time. A partial listing of major concerns include:

<u>Environmental</u>	<u>Non-Environmental</u>
Microwave effects on health, safety and the environment	Microwave communications effects
Launch vehicle emission effects	Cost
Land use/rectenna siting	Internationalization
	Centralization effects

Positive response focused on the SPS as: a possible solution to the energy crisis, an application of solar energy to meet baseload needs, and a general economic restorative. There is also a perception that the SPS will be a "cleaner" energy source than alternative energy systems. If there is one single point that advocates and opponents can agree on, it is that many of the potential impacts of the SPS program (both environmental and non-environmental) are not well understood and require further study.

As a first step in alleviating public concerns and encouraging general participation in the SPS program, it is desirable to identify and establish a dialogue with important segments of the populace. With particular regard to the student population, several methods have been identified which could encourage or facilitate participation in the SPS discussion. The goals of student and public participation programs should be to create a flexible participation structure for direct involvement of the public in the SPS program development. The following criteria, among others, should guide the selection of appropriate participation techniques: placement of the SPS within a broader energy perspective, making the process multi-disciplinary and informational, and providing feedback to the DOE.

The relocation of industries and population due to SPS implementation is dependent upon choice of site and the cost of electrical transmission, among other factors. The cost of electricity, by itself, may not be a sufficient incentive for industry to relocate. Industries most likely to relocate to rectenna site regions are those which consume a significant amount of electricity and have an uncertain energy supply future. Such energy-intensive industries include iron and steel, chemicals, paper, and aluminum. "Boomtown" phenomena have occurred in recent years with the introduction of coal gasification plants in Wyoming and the construction of other new energy generation technologies in rural areas of the U.S. It is likely that this would occur at SPS rectenna sites, too. Growth-induced effects at these sites through population in-migration following industrial relocation are predictable. One approach which can be used to predict local (at the county level) socioeconomic impacts is based on export base theory, which relates net regional migration to basic (i.e., export) economic activity. Computer models have been developed to perform this type of analysis.

At the same time that "boomtown" phenomena have occurred, there has developed a general shift away from centralizing tendencies in the U.S. A militant new regionalism is likely to emerge in the next decade. Conflicts over energy and environmental issues are increasingly perceived as regional conflicts. State and local entities are assuming increasing influence over energy policy decisions, and general public policy matters. This means that the SPS may have to meet regional energy needs if no single national policy exists at the time of its introduction. The SPS may have to conform to a "de facto" national energy policy which focuses on utilization of geographically diverse fuel sources. There is also a trend for the U.S. to become a multi-option society, rather than an either-or society. This flexibility is reflected in the increasing interest in "appropriate scale" for technological innovations, rather than an emphasis on "economies of scale."

An outreach experiment was initiated in an effort to acquire feedback about the SPS concept from three public interest groups: the Citizen's Energy Project, the Forum for the Advancement of Students in Science and Technology, and the L-5 Society. Each group summarized approximately 20 SPS reports and distributed the summaries to 3000 of their constituents requesting their comments and questions. Responses received were submitted to DOE for comment.

The methods adopted to accomplish their assigned tasks were independently chosen by each group. Therefore, the kinds of feedback information received, both qualitatively and quantitatively, are a result of the methods used to obtain this information, and are different for each group. The CEP position is very much in opposition to SPS. This organization advocates decentralized small-scale solar energy systems. Therefore, the two major reasons given for opposing SPS are the trend toward centralization which SPS is indicative of, and the cost of SPS which might extract funds from terrestrial solar alternatives. The FASST position on SPS is relatively neutral. The major focus is on the process of outreach and an effort to include student participation in the development of an advanced technological system. The L-5 position is very much in favor of

SPS. As an organization which is very pro-space and pro-technological development, SPS represents one of many doors into the space frontier. The response to the outreach effort by respondents in all three groups was positive. The opportunity to provide feedback and input in the SPS concept development was appreciated and a pleasant surprise to many. However, there were some questions raised from respondents in all three groups about whether or not public input would actually be utilized.

The U.S. aging population is increasing rapidly. Those "over 65" numbered 3.1 million in 1900 and by 1977 the total climbed to 23.5 million. It can be stated with reasonable certainty that this figure will rise to 31 million in the year 2000 and 43 million in the year 2020. These figures, corresponding to more than 10 percent of our population, are by no means insignificant. This growing constituency is expected to produce substantial social, economic and political influence over the period contemplated for development of alternative energy systems. Energy is used so universally in our daily lives--for lighting, residential comfort, water heating, operating appliances, transportation, etc.--that we seldom think of it for itself, but only for what it can do. It might appear, at first, that age does not play a role in how people demand energy. However, upon further examination, it becomes evident that there are reasons for differing energy demands between age groups. Because the aged generally live on fixed and limited incomes, it follows that their problems have a serious economic aspect. There are also special medical concerns, particularly those related to temperature and lighting, since the aged are particularly vulnerable to situations in which either of these is less than adequate.

A strategy for public involvement is proposed. It is a building-block process which selects components that are compatible with the stage of SPS development, available funds, and the degree of public interest. Several program alternatives are provided, and several options for combining and building programs are offered. The strategy consists of six steps describing a plan of action which can be used repeatedly and periodically throughout the course of SPS development. The six steps are:

- (1) Establish goals and objectives,
- (2) Identify and select participating actors,
- (3) Identify and select SPS issues which should be addressed,
- (4) Select the program task which will facilitate attainment of the goals and objectives,
- (5) Select appropriate methods and techniques for each program task.
- (6) After implementation of methods and techniques, evaluate preceding steps in terms of fulfilling the goals and objectives.

The selection of participating actors, SPS issues of importance, program tasks and methods and techniques are mutually influenced by the selection in each of the others. The selections in all four are influenced by the goals and objectives which have been established. Program evaluation analyzes the results of the implementation of methods and techniques with respect to the goals and objectives. Therefore, all steps in the outreach strategy are interactive.

A COMPARATIVE ASSESSMENT
OF THE REFERENCE SATELLITE POWER SYSTEM
WITH
SELECTED CURRENT, NEAR-TERM AND ADVANCED
ENERGY TECHNOLOGIES

by

Michael R. Riches
Program Manager

The SPS Concept Development and Evaluation Program (CDEP) was established by the Department of Energy (DOE) and the National Aeronautics and Space Administration (NASA) to generate information by which a rational decision could be made regarding the direction of the Satellite Power System (SPS) program after fiscal 1980. The four functional areas within the joint DOE/NASA-CDEP are as follows:

- Systems Definition: development of the SPS reference system design.
- Environmental Assessment: evaluation of potential environmental effects of SPS.
- Societal Assessment: evaluation of potential societal effects of SPS.
- Comparative Assessment: development of a comparative data base on the SPS and other energy systems.

The results of the first three activities are inputs to the comparative assessment process as well as independent program assessments.

This report concerns the Comparative Assessment portion of the DOE/NASA-CDEP. The objective of the comparative assessment is to develop a traceable comparative data base for those making decisions on the SPS and near-term and advanced energy technologies. To achieve this objective, alternative energy technologies were selected, characterized, and evaluated according to a prescribed framework. These evaluations were then integrated into a comparative assessment. This process is shown in Fig. 1. The six-step comparative methodology is described more thoroughly in reference (1). Other Comparative Assessment reports are included in the bibliography. The information presented in these comparisons is for the most part traceable to research reports, cited in the bibliography, on the various energy systems. However, because of its comparative nature, this assessment includes, in some instances, estimates and conclusions based on judgments made from the documented data base. Comparative information was assembled on an issue-by-

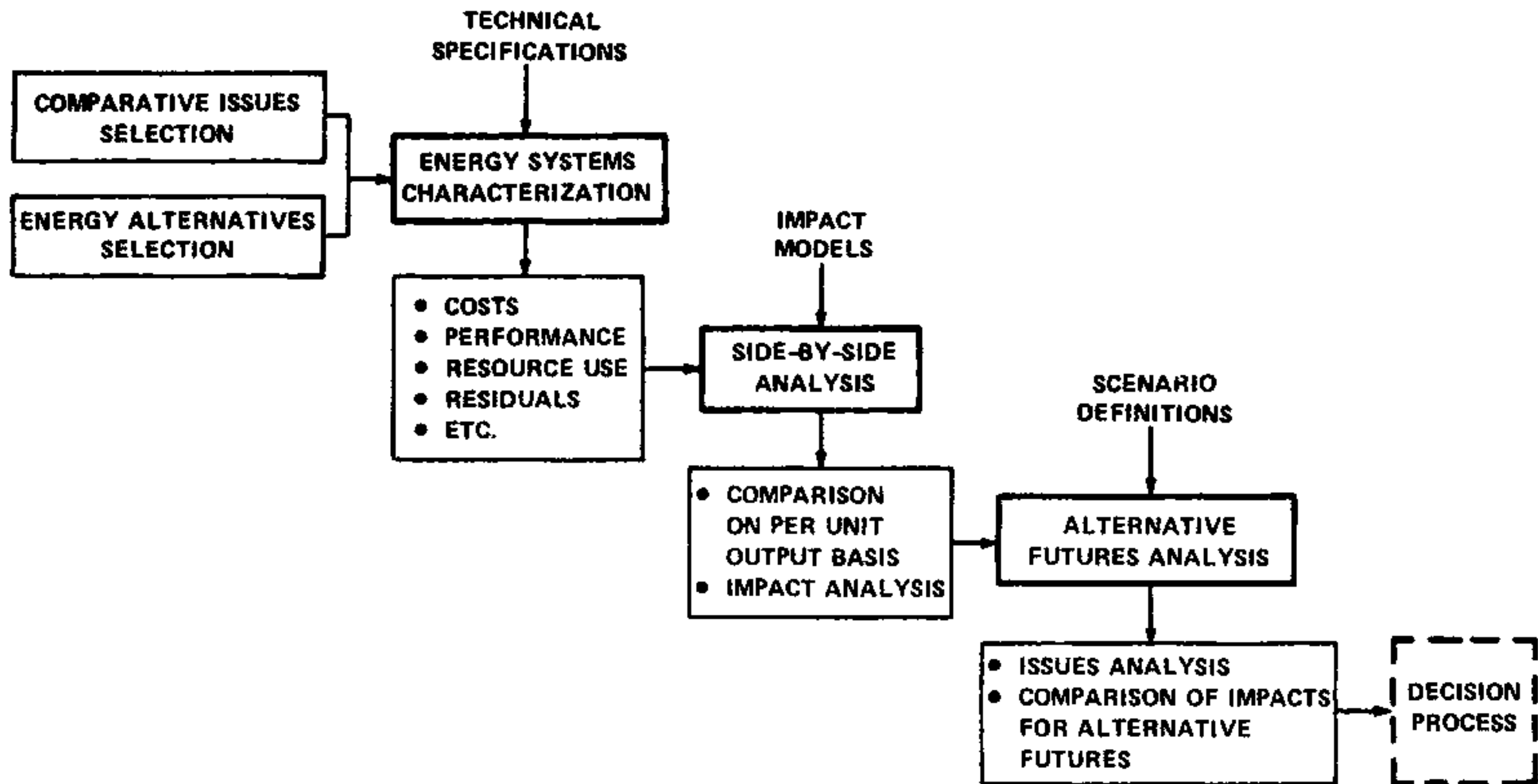

FIG. 1. ANALYSIS SEQUENCE FOR COMPARATIVE ASSESSMENT

Table 1. Developmental Status of the Technologies Selected for Comparison

Tech-nology	Units in Operation	Years Since Start of R&D	R&D Effort	Capital Cost Uncertainty Factor	Cost Uncertainty Issues
Convention-al Coal	>1000	50	Large	2	Fuel, ECT*
LWR	> 50	25	Large	2	Fuel, ECT
CG/CC	5	25	Large	3	Fuel
LMFBR	5	25	Medium	3	Fuel, ECT
TPV	0	5-10	Small	4	Materials, Efficiency
SPS	0	5-10	Small	4-5	Materials, ECT, Space Transport, and Construction O&M
Fusion	0	15	Medium	4-5	Materials, Con-tainment Design ECT

*ECT - Environmental Control Technology

Table 2. Cost and Technology Assumptions for Year 2,000 Technologies*

Technology	Current		Near-term		Advanced	
	Coal	LWR	CG/CC	LMFBR	TPV	SPS
Base Capital Cost (1978 \$/KW)	800	1,200	1,000	1,600	1,200	3,400
High Capital Cost (1978 \$/kW)	1,600	2,800	2,700	4,700	4,200	15,800
High/Low Ratio	2.0	2.3	2.7	2.9	3.5	4.6
O&M Costs (1978 mills/kWh)	4	3	3	3	6	16
Capacity MWe	1,250	1,250	1,250	1,250	200	5,000
Capacity Factor	0.70	0.70	0.70	0.70	0.30	0.90
Heat Rate (kJ/kWh)	10,454	10,982	9,610	10,032	-	-

* Fusion data was not available for publication

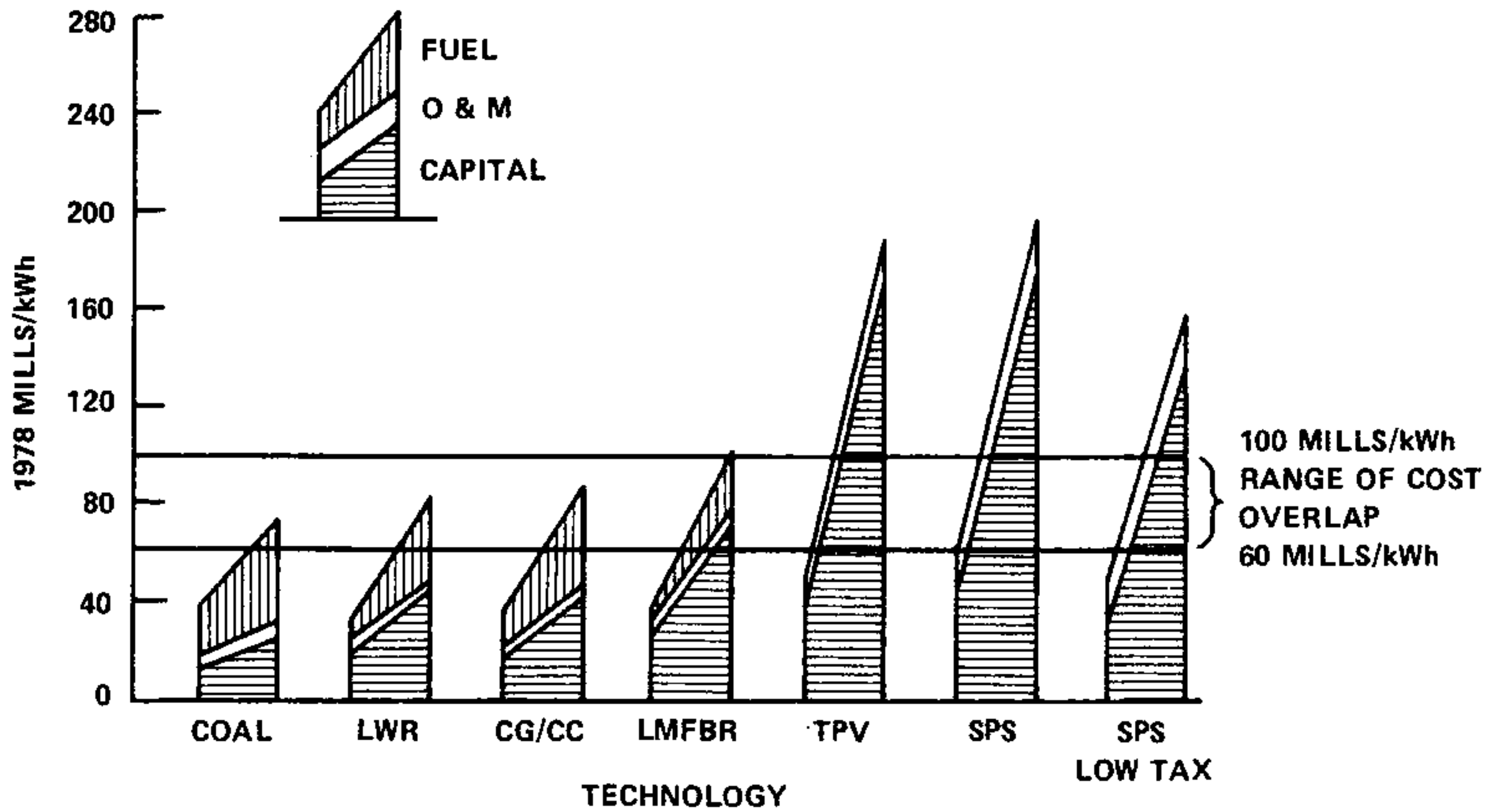

FIG. 2. LEVELIZED LIFE-CYCLE COSTS
(Fusion data not available for publication)

issue basis, and no attempt was made to synthesize the results into a single figure of merit and rank ordering.

Products include the preliminary side-by-side assessment and the alternative futures comparison (to be published in August 1980). The side-by-side comparison is a normalized comparison. The preliminary results are reported as per unit energy output, such as megawatt-year and are based on assumed economic conditions near the beginning of the 21st century. The alternative futures comparison will define plausible economic and energy futures and make comparisons based on the energy and economic climate pertinent to these futures.

PRELIMINARY SIDE-BY-SIDE RESULTS

The six issue areas used for side-by-side comparisons were cost and performance, health and safety, welfare, resources, macroeconomic and socio-economic, and institutional. The comparisons were performed for technologies that are at different states of development -- current, near-term, and advanced -- and therefore have different degrees of information available (e.g., actual vs. projected construction data). Table 1 lists development and experience levels for the technologies evaluated in this preliminary assessment. Capital cost uncertainty factors and cost uncertainty issues are also listed. These cost uncertainty factors were developed on the basis of existing relevant documentation and on the judgment of the assessment participants.

Cost and Performance

A summary of the cost comparisons is shown in Table 2 and illustrated in Fig. 2. The energy cost ranges in Fig. 2 show overlap between the SPS and the alternative technologies. This overlap resulted from the preliminary side-by-side assessment assumptions that used independent cost estimated for each technology and did not take into account the correlated characteristics of their respective cost breakdowns. A correlated data base would provide a more realistic energy comparison and may reduce or eliminate the overlap.

The following key cost drivers* and factors affecting uncertainty were identified in the analysis:

- SPS: capacity factor, technology performance, O&M cost, cell production efficiency, cell cost.
- TPV: cell production efficiency, cell cost, capacity factor.
- CG/CC: gasifier cost, fuel price
- IMFBR: fuel price
- Conventional coal: fuel price

- LWR: fuel price
- Fusion: scientific uncertainty

In comparing costs, it should be noted that the SPS Reference System was developed to guide the assessments and has not been optimized with regard to environmental, economic, or societal benefits. This is also true for the reference systems selected for the alternative concepts. Should the SPS concept, and thus system design options and tradeoffs, continue to be evaluated, it is expected that its projected costs will change.

Health and Safety

The comparison of health and safety aspects of advanced and current technologies is not possible on a total risk basis because of the uncertainties and unquantifiable impacts for all the technologies, even current coal and nuclear technologies. The health and safety results (side-by-side) can best be summarized as follows:

- All the technologies will have distinct health and safety impacts.
- It is difficult to quantify and assess the low-level and delayed impacts of all technologies.

In general, the more defined technologies (e.g., coal, LWR) have a greater number of quantifiable risks and fewer unquantifiable risks. The opposite is true for the less-defined technologies (e.g., fusion, SPS). In contrast to the apparent public willingness to accept limited known risks of energy systems, recent experience with LWR systems indicate that perceived major risks that are less quantifiable or predictable may restrict or completely halt energy system deployment, if adequate assurances of low impact probability are unattainable. In this study, health and safety issues potentially of major concern but currently unquantifiable were placed into two general categories as follows:

1. Low levels of pollutants or radiation, which impose, at most, small individual risks that are not well-understood. However, an exposure of a large number of persons and cumulative effects are of concern.
 - Low-level ionizing radiation from fission reactors.
 - Coal combustion air pollutants that are transported long distances.
 - Low-level microwave radiation (non-ionizing) from the SPS.
2. Catastrophic and perceived events with a probability of occurrence that is thought to be low.
 - Large radiation release from a major fission reactor accident.

- Diversion of nuclear materials from fission reactors for use as weapons.
- Perceived inadvertent acute exposure of a large population to SPS microwave radiation.
- Crash of an SPS heavy-lift launch vehicle or a low earth orbit vehicle into an urban area.

Environmental Welfare Effects

Effects not related to health and safety are classified here as environmental welfare effects, e.g., weather modification by carbon dioxide (CO₂), materials degradation, electromagnetic interference with communications,² aesthetics, and noise. In the side-by-side comparison, only qualitative evaluations of the effects were made. For some issues, definitive work has been done, e.g., SPS electromagnetic interference. Although the CO₂ problem is much discussed, there is certainly no consensus on the risks involved.

Resources

Resource comparisons in this assessment were limited to net energy, materials, and land. The net energy analysis showed that all the technologies are net energy producers if the thermal fuel value of non-renewable fuels is not considered. The SPS and TPV become more efficient producers as the energy efficiency of all production improves (e.g., SPS could go from a 6-year to a 1.5 year payback period for a silicon system). An SPS system utilizing gallium aluminum arsenide was compared to the silicon system and looks promising, but very little information is available to support this comparison.

Each technology (with the exception of the LMFBR) has material requirements that could be considered critical because of environmental control requirements or limited production capability. However, none of these materials appears to be limiting, but a thorough materials assessment based on materials demand and supply, including world demand forecasting, has not been done for all technologies.

Water use by the SPS and TPV is minimal in comparison to that by coal and nuclear systems. Even coal and nuclear systems do not have overall water limitations, but siting is constrained by the availability of water.

Land use was compared on the basis of quantity, duration, and location, and the comparisons were broken down by the different phases of the fuel cycle. The total amount of land required for the complete fuel cycle is roughly the same for all technologies (for SPS and TPV, a little larger). However, the SPS and TPV require large blocks of continuous land and may involve additional long distance transmission because of remote siting, which could cause additional difficulties*.

* However, societal assessment studies to be reported at this program review may show little necessity for SPS transmission lines over 300 Km.

Institutional

Only regulatory issues were addressed in the side-by-side assessment. The SPS, fusion, and other advanced systems may be difficult to operate in the current regulatory climate. The SPS could be additionally burdened by international regulations that do not appear to limit the other technologies.

ALTERNATIVE - FUTURES ASSESSMENT

The alternative futures analysis is the final step in the comparative assessment. It incorporates the results of the side-by-side impact analyses into future energy supply/demand scenarios. While not intended as energy forecasts, the scenarios provide a dynamic framework for examining specific issues and potential problems of various energy technologies under a range of plausible energy futures. More specifically, the alternative futures analysis provides a means for identifying and assessing the conditions under which a SPS system might operate in conjunction with conventional energy systems (e.g., coal and nuclear power) and less conventional energy systems (e.g., low BTU coal gasification and fusion).

The alternative futures analysis involves three supply/demand scenarios:

- o Low electrification (340 MWe of electrical capacity)
- o Intermediate electrification (540 MWe of electrical capacity)
- o High electrification (1700 MWe of electrical capacity)

The low electrification scenario assumes that constraints on the use of coal, nuclear energy and petroleum will increase. Moreover, consumers will prefer decentralized energy options and that a moderate substitution of capital for energy will occur. Hence, energy conservation efforts will be increased, and there will be less demand for electricity.

The intermediate scenario assumes that constraints on the use of coal and nuclear energy will remain substantially as they are in 1980 (constraints on the use of oil and gas are assumed to be constrained in all cases). Although energy consumers will engage in a moderate amount of energy conservation, the demand for electricity will continue to increase. Moreover, consumers will prefer centralized energy sources. The intermediate scenario appears to be the most likely case.

The high case also assumes that constraints on the use of coal and nuclear energy do not increase. In addition, the "high electric" case is one in which most uses of energy are supplied by electricity. In this case, a centralized energy system is the only realistic alternative.

In the alternative futures analysis, these scenarios are used to examine the results of the energy characterizations and side-by-side analysis in a

dynamic framework of possible future energy conditions. Four steps are involved: First, a mix of energy technologies is specified. Second, the scenarios are used to project each technology's share of future energy demand. Next, the overall impacts of each energy technology are extrapolated for the respective demand level. Finally, the results of the impact projections are analyzed and threshold levels are specified for the six issue areas. The six issue areas include health and safety, resource requirements, macroeconomics, socioeconomics, welfare effects, and costs.

For the health and safety area, the scenarios and quantification (wherever possible) of the total potential public and occupational health and safety effects associated with each fuel cycle for a given level of energy demand. Similarly, the alternative futures analysis looks at the demand for resources (e. g., land, water, and materials) over times and the impact of each fuel cycle on the GNP, the rate of inflation and unemployment, interest rates and investment.

In the socioeconomic area, the alternative futures analysis employs the scenarios to "qualitatively" examine the regional efforts of each technology under the three demand scenarios. The scenarios are also employed to quantitatively and qualitatively assess the respective welfare effects of each fuel cycle. Finally, the alternative futures analysis uses the scenarios to specify the costs of producing the electricity demanded given the demand and the technology mix.

FINAL COMMENTS

It was not the objective of this comparative assessment to make direct comparisons between the technologies alternative to the SPS (e.g., between coal and central-station photovoltaics or between fission and fusion). The assumptions of the assessment were designed to allow comparison of the SPS to the alternatives, and cross-comparisons among the alternatives would be valid under some, but not all, of these assumptions.

In all comparative assessments it is vital that the assumptions, uncertainties, and inconsistencies that exist between the systems being compared are clearly and objectively presented. Otherwise the comparison may provide limited, if any, information on which to make meaningful decisions.

It is intended that the data supplied in this comparison will aid in increasing knowledge and thereby decreasing uncertainty for the decision maker as he or she evaluates the initial SPS concept.

REFERENCES

1. Wolsko, T., et al., *A Methodology for the Comparative Assessment of the SPS and Alternative Technologies*, DOE Report (In press).

BIBLIOGRAPHY

- Cirillo, R.R., et al., *Comparative Analysis of Net Energy Balance of Satellite Power Systems and Other Energy Systems*, DOE Report (In press).
- Habegger, L.J. Gasper, and C.D. Brown, *Health and Safety: Preliminary Comparative Assessment of the SPS and Other Energy Alternatives*, DOE Report (In press).
- Harza Engineering, *Utility Interface Requirements for a Solar Power System*, DOE/ER -0032 (Sept. 1978)
- Kellermeyer, D.A., *Climate and Energy: A Comparative Assessment of the SPS and other Energy Alternatives*, DOE Report (In press).
- Levine, E.P., et al., *Comparative Assessment of Environmental Welfare Effects of the Satellite Power System and Other Energy Alternatives*, DOE Report (In press).
- Newsom, D. E., and T.D. Wolsko, *Preliminary Comparative Assessment of Land Use for Satellite Power Systems and Alternative Electric Energy Technologies*, DOE Report (In press).
- Poch, L.A. and T.D. Wolsko, *A Review of the Nuclear Safeguards Problem*, ANL/EES-TM-67 (Oct. 1979).
- Poch, L.A. and T.D. Wolsko, *A Review of the Nuclear Waste Disposal Problem*, ANL/EES-TM-68 (Oct. 1979).
- Samsa, M., *Selection of Alternative Central Station Technologies for the Satellite Power System Comparative Assessment*, DOE Report (In press).
- TRW, Energy Systems Planning Division, *Characterizations of Advanced Power Plant Technologies*, Draft Report, Prepared for Argonne National Laboratory (August, 1979).
- United Engineers and Constructors, *Satellite Power System and Alternative Technology Characterization*, UE&C-ANL-790831, Prepared for Argonne National Laboratory (August 1979).

United Engineers and Constructors, *Satellite Power System Cost Review*, UE&C-ANL-790831, Prepared for Argonne National Laboratory (Nov 1979). In press as DOE report.

U.S. Department of Energy and NASA, *SPS CDEP Reference System Report*, DOE/ER-0023 (Oct. 1978).

Wolsko, T.D., et al., *A Preliminary Side-by-Side Comparative Assessment of the Satellite Power System and Alternative Technologies*, Technologies, DOE report (in press)

A Footnote to the Comparative Assessment Review

The SPS Comparative Assessment program has as its objective -- "To develop a traceable data set that will aid in increasing knowledge and thereby decreasing uncertainty for the decision maker as he or she evaluates the SPS concept" -- all within the overall SPS CDEP objective. That is, from the Comparative Assessment point of view, are there any insurmountable problems for SPS?

The reports presented and the questions and comments received support our assertion that we have achieved our objectives, to provide a traceable and objective data set. It remains to communicate the results in the final report, noting the benefits and concerns surrounding the issues of the SPS reference system and concept as compared to the selected alternatives.

The overall finding is that within the assumptions, uncertainties, and scope of the assessment, no comparative issues appear as insurmountable barriers to the SPS concept.

AN OVERVIEW ON EUROPEAN SPS ACTIVITIES

K. K. Reinhartz

European Space Agency

European Space Research & Technology Centre, Noordwijk, The Netherlands

1. Introduction

Satellite Power Systems have now been studied in Europe for at least six years. Both national and international government agencies and industry have been involved in evaluating the potential contribution of an SPS to the European energy supply and to assess the potential impact on European industry of European participation in an SPS programme. So far this effort has been at a much lower level than in the United States. A large part has been a critical review of the work performed in the United States, but in addition an effort has been made to identify problems that would be specific to a European application of the SPS and to study possible solutions to these problems.

To assist understanding of the complicated institutional framework in which European SPS activities take place, it is useful to review first the organization of space and energy research in Europe before describing the activities themselves in more detail.

In Europe space research and space technology development is pursued at both an international and a national level. Most of Europe's international space activities are the responsibility of the European Space Agency (ESA), which was formed from the two earlier European space organizations: The European Space Research Organisation (ESRO) and the European Organisation for the Development and Construction of Space Vehicle Launchers (ELDO). ESA's Member States are Belgium, Denmark, France, Germany, Ireland, Italy, Netherlands, Spain, Sweden, Switzerland and the United Kingdom. Other countries, e. g. Austria, Canada and Norway participate in selected Agency programmes. In addition to the joint European programmes, several of ESA's Member States have national space projects, which they conduct alone or bilaterally with other European countries or with the United States.

In space research and technology development, the joint European programmes of ESA represent the major part of the overall European effort. The situation is very different for energy technology. There are joint European programmes, mostly funded through the Commission of the European Communities, but they represent only a small part of the total effort in Europe, which is mainly controlled at national level. The major energy activities of the European Communities are the Joint European Torus (JET) experiment on thermonuclear fusion and the work at the Joint Research Establishments concerned mainly with nuclear-energy-related research.

In addition to the Communities programme, several European countries participate on an individual basis in energy research projects organized under the auspices of the International Energy Agency (IEA) of which most Western countries are members, including the United States and Japan.

2. The European Energy Situation

Only thirty years ago Europe was almost self-sufficient in energy. Since then, however, its consumption has more than doubled and the additional demand has had to be met with imported energy, mostly in the form of oil and gas. Recent events

have demonstrated just how dangerous this import dependence can be for economic and social development, and all countries in Europe have been prompted to initiate large-scale research and development programmes aimed at reducing their dependence on imported energy.

Growing public awareness of the limitations and drawbacks of each of the available energy sources has led to recognition of the fact that no single source will be able to meet even a major part of our energy demand in the future. The non-renewable sources such as oil, gas, coal and uranium, and the renewable or almost inexhaustible sources such as wind, hydro-power, biomass, direct solar energy conversion or nuclear fusion, are all limited in their use by geographical, environmental, economic or political factors. Compared with other parts of the world, Europe is in a particularly difficult position because most of its primary energy resources, such as oil, gas and geothermal energy are relatively small, while coal reserves are relatively large but difficult to mine, uranium is scarce, and even sunshine is not very abundant.

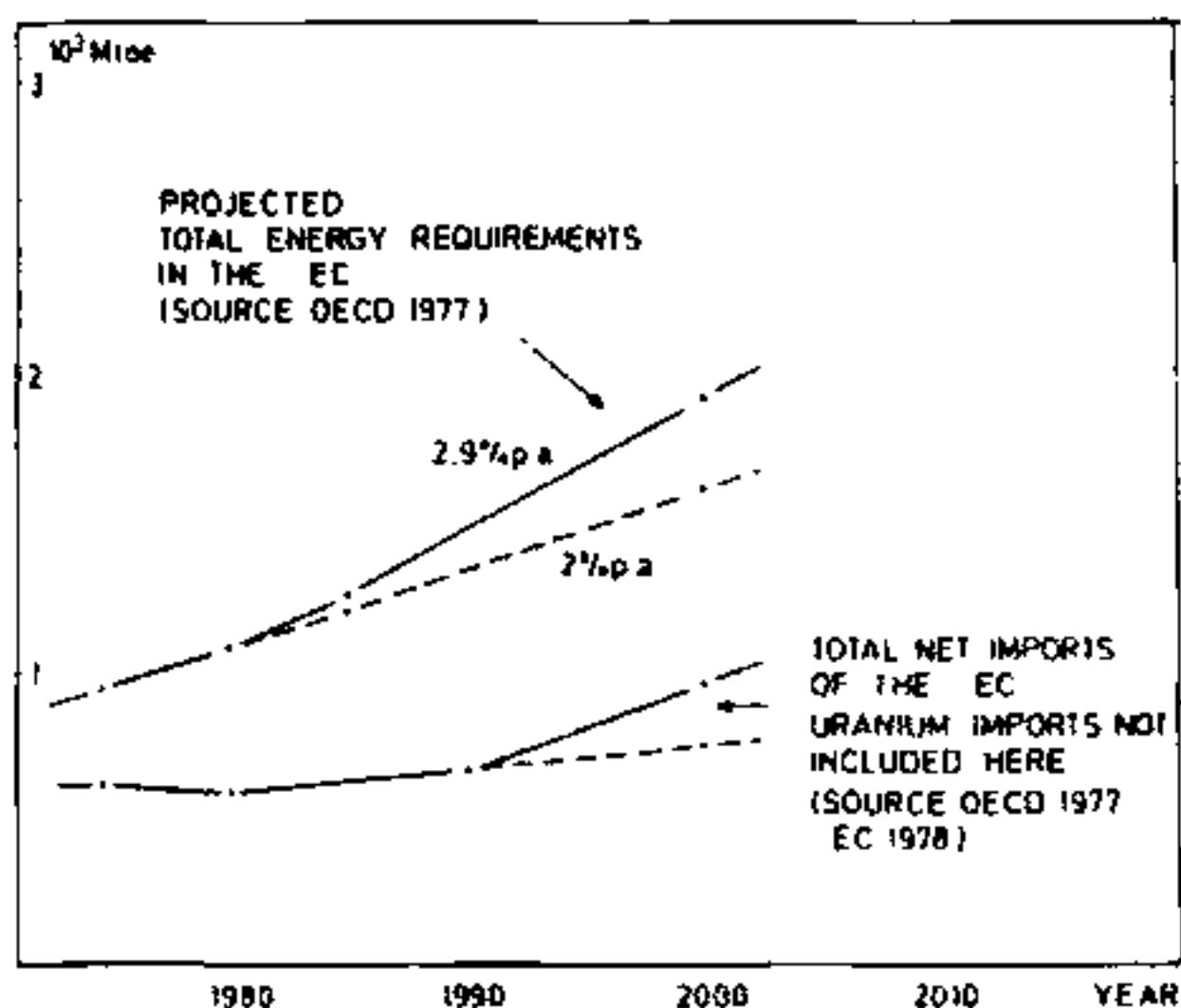

Figure 1

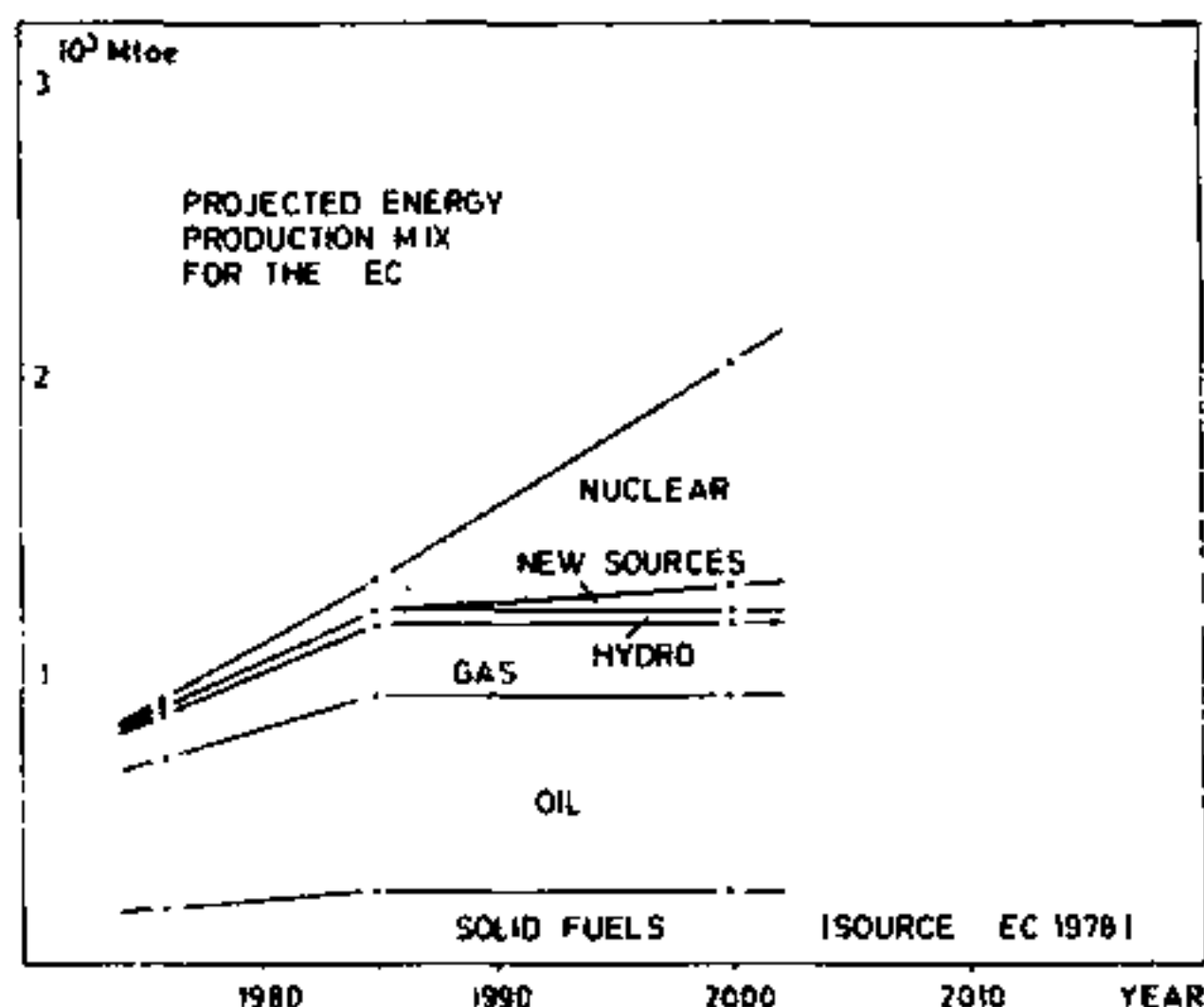

Figure 2

Europe now imports between 50 and 60% of its energy needs. Figure 1 (1) shows the projected energy demand in the European Economic Community (EEC) and the estimated import needs. Figure 2 shows a more detailed projection of the expected energy mix (2,3). Bearing in mind that most of the uranium has also to be imported, this projection indicates an even larger EEC dependence on imported energy in the future. Europe's precarious energy situation can be illustrated by the fact that at present, the indigenous primary energy production per capita in the United States is more than 2,5 times that in Europe and this ratio will probably increase with time, in view of the much larger fossil fuel resources in the States.

Unfortunately, it will also be more difficult for Europe to develop the use of renewable energy sources. For example, the average annual insolation in central Europe is about 1000 kWh/m², compared with 2500 kWh/m² in Arizona. Southern Europe has higher insulations, up to approximately 1700 kWh/m² in Southern Spain, but in most parts it would be very expensive and, because of the need for very

large capacity storage, technically difficult to use solar energy for electricity generation. In central Europe the cost of solar electric power would be more than 2,5 times higher than in large areas of the United States, considering that the installation cost of a solar electrical generation plant is more than inversely proportional to insolation for a given capacity.

The EEC's energy-supply projection foresees some contribution from new sources or technologies other than fossil fuels and nuclear energy (3). It is estimated that these may provide 2-5% of the energy needs in the year 2000, but none are expected to have a significant impact on Europe's overall energy supply. The total contribution from solar energy is not expected to be more than 1 or 2%, compared with 20% in the United States' plans.

3. Status of European SPS Activities

Investigation of the SPS concept started in Europe approximately six years ago and National Agencies as well as the European Space Agency have tried to evaluate its viability for Europe. Most of the studies were initiated by departments or organizations associated with space research and technology. The energy departments of European governments have so far not shown any great interest in the idea.

The first significant effort was a detailed study of the SPS concept performed under a contract from the German space research organization (4). The work was performed in 1974/75 and its results were used and further extended in an extensive analysis of the use of solar energy in general, which was performed by a group of German firms and research institutions under contract from the German Ministry of Research and Technology (BMFT). This later study (5) led to the conclusion that for a country like Germany the potential advantages of an orbital solar power station are significant when compared with terrestrial solar power stations, since the relatively small amount of solar radiation energy available at the earth's surface, together with the unfavourable annual variations makes use of terrestrial solar power plants not very attractive. It was also pointed out, however, that a number of basic questions had to be investigated before specific technical problems should be studied. Examples of the basic questions raised were the environmental aspects, the cost of space transport and solar-energy conversion, the feasibility of controlling very large structures in space, and the analysis of alternative technical SPS configurations. However, despite the rather positive assessment of the SPS compared with terrestrial solar electrical power generation, the German Government did not continue its investigation.

More recently the Department of Industry in the United Kingdom funded a study of the SPS as part of an investigation of the industrialization of space. This study (6), which was completed early in 1979, discussed the technological and environmental aspects of the SPS as well as its potential contribution to the European energy supply. It also addressed the economic and political issues involved in the manufacture and operation of the SPS.

The conclusion was that the problems associated with the SPS were no different in scale from those associated with other options for supplying our future needs of baseload electricity, e.g. fossil fuel burning or nuclear fission. Any differ-

ence was thought to lie more in the nature of the mix of problems associated with the different energy sources than in their absolute magnitude. The study also recommended that, prior to making any significant financial commitment to SPS specific technology development, the United Kingdom should first investigate such basic issues as:

- the advantages and disadvantages of adding the SPS to existing or projected candidates for future baseload electricity supply
- the possible locations for rectennas for meeting European power needs
- the environmental impact of SPS operation
- the probable timescale for technology development and operational applications.

Late in 1979, the UK Department of Industry awarded a further contract to a group of companies led by British Aerospace, to study the implications for UK industry of the implementation of Solar Power Satellites. The major objectives of this contract are:

- to assess and identify all direct and indirect design areas and hardware technologies involved in SPS development and operation
- to identify potential opportunities for UK industry
- to attempt to quantify these opportunities and to recommend future actions.

In addition, British Aerospace has initiated an in-house effort to investigate certain technical aspects of the SPS that are particularly critical for Europe:

- Study of several methods for reducing the rectenna area, e.g. combination of laser and microwave power transmission by using a stratospheric platform to convert laser energy into microwave energy or splitting of a 5 GW beam into several smaller beams.
- Assessment of radio-frequency interference, both with ground and spaceborne communication systems, and definition of possible mitigating approaches.

In France, M. Claverie and A. Dupas of Centre National de la Recherche Scientifique (CNRS) have investigated the SPS's potential role as a solar-energy conversion system compared with terrestrial solar power plants. They first made an assessment of the potential World market for terrestrial and space solar power stations (7) and came to the conclusion that solar electrical power generation in space and on the ground can complement each other. This conclusion is based on the assumption that a large part of the electrical power needs have to be supplied by large centralized baseload power stations, including power satellites, but that in addition there is a significant market for decentralized electrical energy generation, mainly in areas that have high insulations and/or lack a power grid infrastructure.

More recently Claverie and Dupas (8) have studied in greater detail whether the SPS is the only practical option for generating baseload electrical power from

solar energy. They compare SPS and terrestrial photovoltaic energy conversion plants, in combination with storage systems to provide continuous power-generation capability. The preliminary conclusions are that terrestrial photovoltaic power stations may be able to compete with SPS stations as baseload power plants, both in terms of investment cost and land requirement in locations with high insulations such as the Southwestern parts of the United States, but not in central Europe. They recommend further study of this issue.

The European Space Agency started to assess the SPS concept in 1977. Following an initial compilation of the literature, the Agency's work has been oriented in three main directions:

- collection and distribution of technical information on the SPS in order to stimulate a discussion on the potential role of an SPS in the future European energy scenario
- identification of those aspects in the development and operation of an SPS that would be different in the United States and Europe
- study of selected SPS technical problems in order to identify possible areas for European research and technological development.

As a part of the dissemination of the technical information being gathered, a number of articles (9,10) have been published in ESA journals and a round-table discussion has been organized (12). The SPS was also discussed in a position paper prepared for the Agency's Member States and used as an input to the 1979 WARC, proposing consideration of the SPS by allocating an adequate frequency band to energy transmission (13).

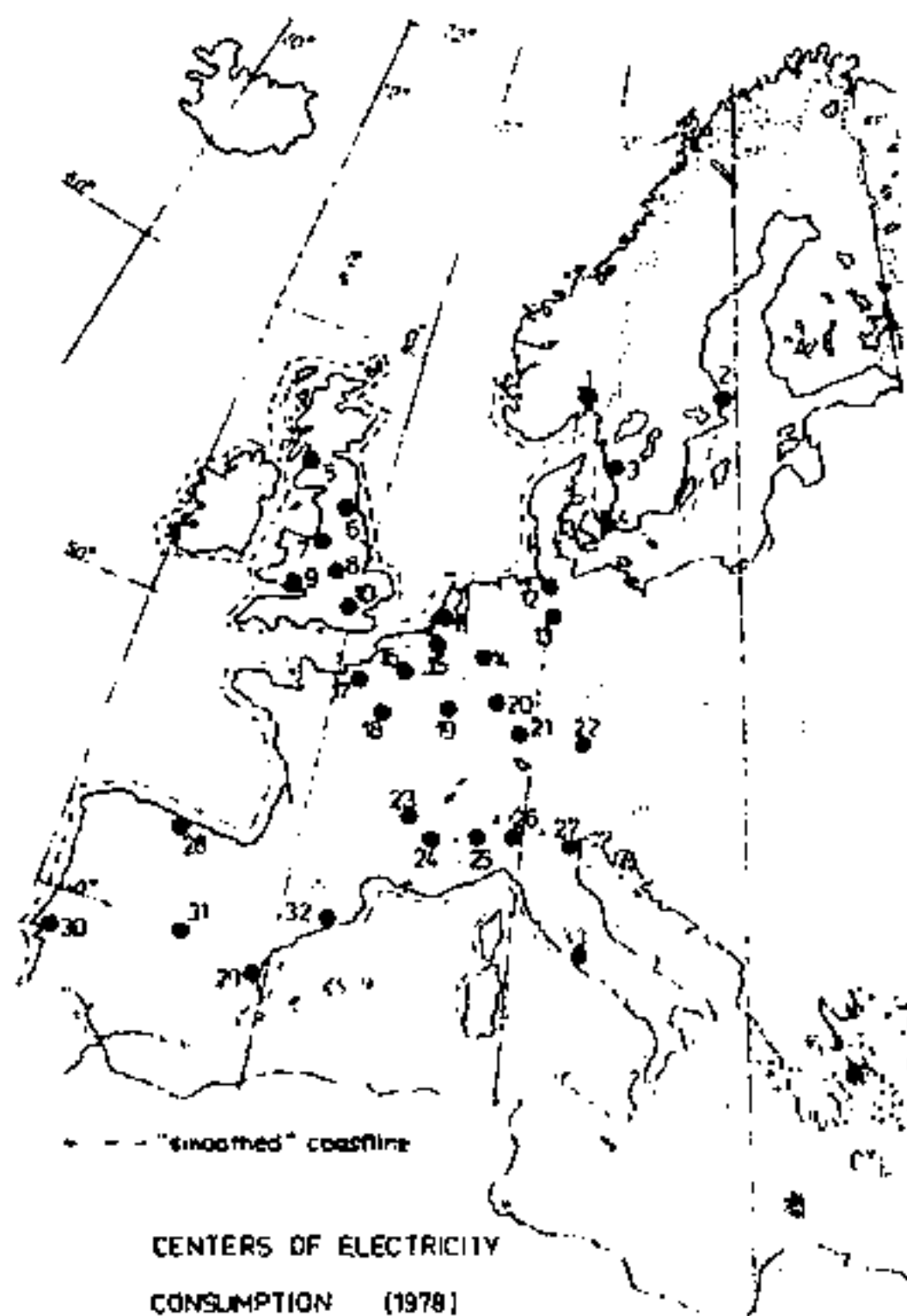

Figure 3

In 1979, J. Ruth and W. Westphal of the Technical University of Berlin performed a preliminary study (14) of the European aspects of solar power satellites under ESA contract. Some specific European factors were identified in this study.

The Western European countries lie in the longitude range 24°W to 30°E , and in the latitude range 36°N to 72°N . This area is not only considerably more northerly than the United States but it also includes a considerable number of East European countries, a fact that could give rise to serious political problems.

Most of the major centres of electricity consumption, defined as circular areas of 100 km diameter and with consumptions of more than 3 GW, lie roughly between 45°N and 55°N (Figure 3). If SPS rectennas were to

be placed near these major consumption centres, very large tracts of land would be needed. Even without longitude offset, the size of a rectenna and associated safety zone at 53° latitude would be almost twice as large as at 30° latitude, taking the beam geometrics of the United States' reference system as a guide (17). The long axis of the ellipse forming the safety zone (corresponding to a maximum microwave intensity of 1 mW/cm² with the beam energy distribution defined in the United States' reference system) would become 44 km instead of 26 km with a short axis of 20 km. The area would grow from 400 to 730 km² as shown in Figure 4. The situation would be worse if longitude offset had to be included, because most of the major consumption centres lie between 5°W and 10°E.

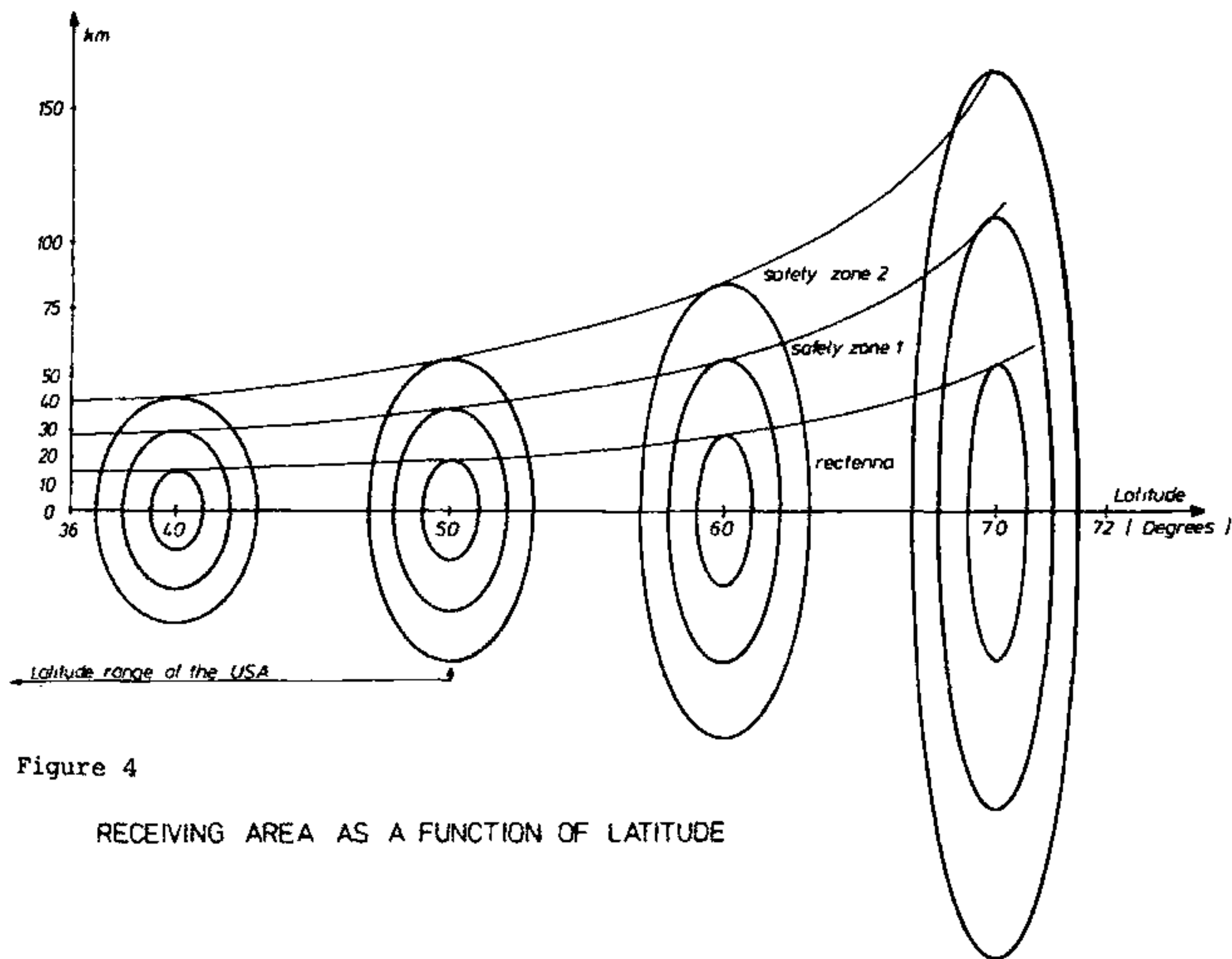

Figure 4

RECEIVING AREA AS A FUNCTION OF LATITUDE

Because of the high population density in the European region with the highest electrical power consumption, it would not be possible to place rectennas of the size defined in the United States' reference system near the consumer, without moving considerable numbers of people. As Figure 3 shows, European conditions are more favourable for placing rectennas offshore. More than 80% of the major consumption centres are located within 300 km of a coastline. In addition, large parts of the relevant offshore regions are relatively shallow, with depths of between 10m and 50m.

Since the land for rectenna sites is so severely restricted and European industry has considerable experience in the construction of offshore structures (from the North Sea oil exploration), the problem of siting rectennas offshore has been further investigated by P. Collins (16).

Neglecting the specific problem of interfacing power satellites with a utility grid, the 5 GW per unit of the United States' reference system does not seem to be a problem in itself. At present, there are already blocks of three to five nuclear power plants with capacities of 1 GW each in the planning stage in several European countries. The national grids in Europe are also widely interconnected. In addition to the member states of the UCPTTE (15) (Union for the Co-ordination of the Production and Transport of Electrical Energy) Austria, Belgium, Federal Republic of Germany, France, Italy, Luxemburg, Netherlands and Switzerland, Spain, Portugal, Yugoslavia, Denmark and Greece are connected to a European network.

The United Kingdom and the Scandinavian countries are also connected to the UCPTTE grid, via direct current lines.

The exchange of electrical energy between national grids is constantly increasing. In 1977, 51,000 GWh, corresponding to 5.9% of the total electricity generated, were exchanged between the UCPTTE member states alone. The maximum power exchange at any given time during 1977 between UCPTTE countries was 8.3 GW. The capacity of the lines crossing the borders of the Federal Republic of Germany, for example, was 21,600 MW in 1977.

In addition to restrictions imposed by the size of the sites needed for rectennas, the potential contribution of an SPS to the European energy supply could also be limited by spacecraft orbital location constraints. West to East Europe extends from 10°W at the West coast of Ireland, to 25°E, at the West coast of Turkey. It is not yet clear what the minimum separation for power satellites in geostationary orbit would be. Preliminary estimates assume a separation of 0.5° corresponding to a maximum of 70 satellites in geostationary orbit within the longitudinal boundaries of Europe. In practice, the number available to Western European countries would be lower than this because of the needs of East European or African countries falling within the same longitudinal band.

The availability of orbital space may become an important factor in the assessment of Europe's interest in the SPS. It has been estimated (14) that the minimum energy production from the SPS necessary to justify the development of such a technology would be approximately 10^3 TWh/year, which corresponds to the EEC's present electrical power consumption. This lower limit would call for approximately 25 satellites, each with an output of 5 GW.

4. Prospects for European Activities

Any future European activity in the SPS field will be strongly influenced by the fate of the SPS project in the United States. A significant effort in Europe can only be expected if the United States' Government decides to continue and increase its SPS activities beyond the present three-year assessment phase. Until this decision is taken, the European effort is expected to continue at its

present level. ESA will continue system studies with the major aim of investigating possibilities for reducing the surface area needed for rectennas. ESA is also planning to study the impact that an SPS technology and development programme would have on the European space programme.

A major step in such an analysis will be the selection of areas for potential European activities, assuming that Europe would participate in a joint international programme. Typical selection criteria for early programme phases would be:

- that results are also applicable to other European space programmes
- that Europe has a significant technological advantage in a subject
- that the results of the activity are very important for SPS programme decisions in Europe
- that a high production volume with a large "added value" could be expected.

Any future technological research in Europe can make use of a well-established infrastructure, both in space and in energy technology. Europe's space programmes started more than fifteen years ago and the national and international budgets for space research and technology are presently of the order of \$1,150 million per year. European space activities embrace the whole spectrum of space technology, supporting complex scientific missions, satellite communications, spacecraft, launcher development and the manned Spacelab. (11).

The availability of the Ariane launch site at Kourou, French Guyana, which is ideally situated for launches into geostationary orbit, might prove particularly interesting. The low latitude and low population density associated with this site could represent substantial advantages for an SPS programme. (Figure 5).

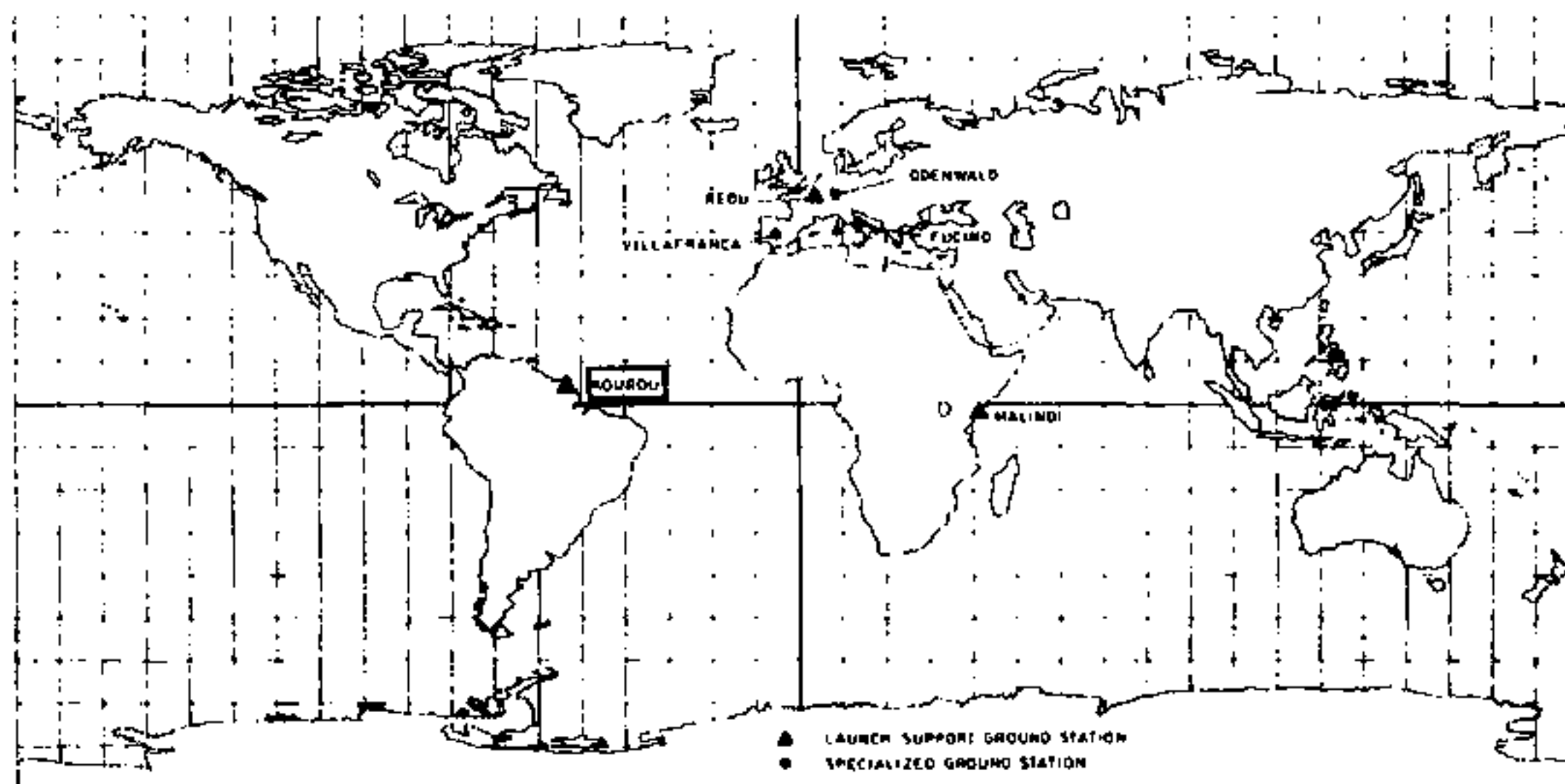

Figure 9 - European launch site, Kourou, French Guyana

In addition to investigating the potential impact of an SPS technology programme on European space activities, ESA will continue to promote the assessment of the SPS concept in Europe through the organization of working groups. The present lack of communication between space and energy organizations makes it very difficult to come to a comprehensive understanding of the potential benefits and penalties of using the SPS as part of the European energy supply.

5. Conclusions

At present, Europe's energy needs are satisfied mainly by oil, coal, and natural gas. More than 50% of this energy is imported, mostly as oil. Current predictions assume that the demand will grow and that Europe will continue to import at least 50% of its energy needs.

In view of the unfavourable geographical and climatic situation of large parts of Europe, terrestrial solar energy conversion is unlikely to make a significant contribution to Europe's future energy supply. The use of solar energy via the SPS approach could therefore prove to be of major interest if its technical, economic and societal viability can be demonstrated for European conditions.

The SPS is being studied in several European countries and by ESA. The total effort has been considerably smaller than in the United States, but a number of specific European aspects have already been identified and will be studied further. Because of the compactness and much higher population density of Europe, it will be very difficult for example to find suitable rectenna sites on land. Reduction of individual rectenna areas and/or the placing of rectenna offshore will be very critical as far as the acceptability of the SPS for Europe is concerned.

Part of the European studies involves analysis of the role that Europe might want or might be able to play in an SPS technology and development programme. Europe has a good space-technology infrastructure combined with considerable experience in planning and executing international space projects and this could form the basis for strong European participation in a joint international SPS venture with the United States and other countries. A specific European problem is the fact that there is no European equivalent to the Department of Energy in the USA which could co-ordinate and fund the European elements of an SPS programme. Based on its technical expertises and its experience in the management of large international projects, ESA could undoubtedly play a major role in any future European SPS activities and it will therefore continue to investigate system aspects and selected areas of relevant space technology.

References

1. OECD: World Energy Outlook, Paris 1977
2. CEC: Report COM (78) 613, Brussels 1978
3. Strub A, EC Energy Structure, Proc. European Symp. on Photovoltaic Generators in Space, ESTEC, September 1978, ESA SP-140, pp. 295
4. AEG-Tfk et al, Analyse der technologischen Entwicklungsprobleme für den Einsatz Orbitaler Systeme zur Energieerzeugung im bzw. der Energieübertragung aus dem Weltraum, May 1975, RV 11-v 67/74 - PZ - BB 74
5. ASA/AGF, Energiequellen für morgen? Teil II: Nutzung der solaren Strahlungsenergie, 1976
6. GTS, Report on Study Field 'B'. . ., No. GT 78008/B-1-3, February 1979
7. Claverie M. J. and Dupas A.P., The Potential Global Market in 2025 for SPS, AIAA 79-1373
8. Claverie M. J. and Dupas A. P., Terrestrial v.s. Space Baseload Solar Electricity, IAF 79-172
9. Kassing D. and Reinhartz K. K., Energy for Europe from Space? ESA Journal 1978, Vol. 2, No. 3, pp 179-187
10. Stoewer H., Reinhartz V. K. K. and Kassing D., The SPS as a Future European Source, ESA Bulletin No. 21, pp 8-14
11. Stoewer H., Tilgner B. and Kassing, D., European Technology Applicable to SPS, IAF 79-174
12. ESA Symposium: Photovoltaic Generators in Space, Round Table: Space Power Generation for Europe?, Proceedings pp. 293, September 1978
13. ESA Position Paper for 1979 WARC, ESA/C (78) 99
14. Ruth J, and Westphal W., Study on European Aspects of SPS, ESA Report No. CR (P) 1266, 1979
15. UCPTE, Annual Report 1978/79
16. Collins, P. Q., Feasibility of Siting Rectenna Systems over the Sea, IEE-Colloquium on SPS, London 1979
17. DOE/NASA, SPS-Reference System Report, October 1978

SPS Issues: The Need to Look Ahead
Kevin K. Dybdal
St. Olaf College

The implementation of satellite power systems (SPS) will have a very broad impact upon the future generations of this world. SPS will have consequences in national economies, in political policy decisions, in attempts to achieve energy independence, and in international cooperation. Thus, there is a need for a systemic examination of SPS for the purpose of identifying potential problem areas and the issues related to those areas.

A systemic approach (e.g., Thorsheim, 1979; Toren, 1980) is a valuable perspective from which to evaluate SPS implementation as a reliable, safe, and cost-efficient energy supply of the future. It allows for the identification and examination of the individual issues and areas of concern, and has the added feature of recognizing the existence of interrelationships and interdependencies. A systemic perspective allows decision making to be based within a broad context.

This paper examines only a few of the numerous points to be addressed during the early stages of SPS research and development. Many of the problems that are encountered in the attempt to develop satellite power systems are not unique to this project. Therefore, results of research into SPS will have applications in many other areas. The AIAA in their Solar Power Satellites position paper (1979) states "... that a great deal of the technology applicable to SPS systems is needed for other projected space applications." Perhaps some way could be found of coordinating and sharing research in these areas. The cost of SPS development may then become more justifiable.

Reliability

Reliability and the ability of an energy source to supply electricity without interruption will be important concerns for the future. Satellite power systems (SPS) are attractive because of their ability to collect and transmit energy almost 100% of the time that they are in operation. Such continuous power generation enables them to operate as base-load energy supplies, giving them an advantage over earth-based solar energy systems that will be affected by day/night cycles and atmospheric conditions (Glaser, 1979).

Reliable satellite power systems should be free from slow-down or shutdown. They will be more attractive if they are not susceptible to loss of power due to system damage, hardware failure, tracking error, sabotage, or military threat.

Because the reliability of each individual part of any system has a direct bearing on the total system reliability, a systemic perspective is valuable.

Safety

The biological and environmental safety of SPS will be important future concerns (Grey, 1978; Manson, 1980). Such concerns will be particularly important to the generations that will have to deal with any long-term effects of SPS implementation.

The examination of possible problem areas (e.g., long-term effects of microwave transmission, worker safety in outer space, and environmental impact) can be aided by a systemic approach. Variations in system design, operational procedures, and managerial policy will all have impact upon safety. Decisions affecting the safety of SPS will be more appropriate if they are based upon an understanding of the complex interrelationships involved in SPS.

Cost-efficiency

The future of satellite power systems will also be related to their cost-efficiency. The probability of SPS becoming a part of our energy future will increase if the system can provide base load electrical energy at costs competitive with other energy systems.

SPS could reduce the current dependence of nonrenewable energy supplies. The cost of that independence may be economically, ecologically, or politically greater than we wish to accept. We need to act now to study the problems and potentials of this energy system. Only after we gain a better understanding of the system as a whole can we hope to make intelligent decisions regarding its implementation.

Exploration into multinational funding for SPS needs to be supported. SPS will require large amounts of capital investment for research and development. Multinational funding would ease the burden for any nations wishing to develop satellite power systems. The development of a multinational SPS operational organization may reduce the risk of military action against any of the satellites in the system (Manson, 1979). Several nations are now demanding equatorial orbit sovereignty (Barna, 1979). A multinational SPS program would allow better negotiation with these countries. Cooperation on an international level could prove to be a major boost for the economic future of SPS.

The investment payback rate will be an important consideration. SPS will receive more support if its research and develop-

ment costs can be amortized within a reasonable time period.

Conclusion

The safety, reliability, and cost-efficiency of satellite power systems are all interrelated. A reliable and safe system will be less likely to incur extra costs because of slowdowns or shutdowns. Large investments occurring early in the development phase may be offset by increases in system reliability and safety. These increases would help the systems achieve their full economic potential.

Reliability, safety, and cost-efficiency are not the only issues in the SPS program. But they are important areas to examine, and a systemic approach can be a valuable tool.

Resources

AIAA Position Paper, Solar Power Satellites, Astronautics & Aeronautics, Vol. 17, No. 1, January 1979, pp. 14-17.

Barna, Becky. Wanted: Space in Space. DATAMATION, Vol. 25, No. 10, September 1979, pp. 87-89.

Glaser, Peter E. The Outlook for Solar Power Satellites. Paper presented at The Council for Energy Studies Conference on World Energy Economics IV, London, England, February, 1979.

Grey, Jerry. Testimony before Subcommittees on Advanced Energy Technologies and Energy Conservation Research, Development, and Demonstration and Space Science and Applications; Committee on Science and Technology; U.S. House of Representatives; Ninety-fifth Congress, Second Session, April 12, 1978. (No. 68).

Manson, Simon. Personal Communication, January 24, 1980. (Manager, Satellite Power System Program, NASA, Washington D.C.)

Thorsheim, Howard I. General Systems Theory: A Logic-Of-Inquiry For Alternate Human Futures. Paper presented at the 24th Annual Meetings of the Society of General Systems Research, meeting with the American Association for the Advancement of Science, San Francisco, January 1980.

Toren, Brian K. The Meaning of General Systems Theory. System Trends, 2(3), 1980, pp. 3-4.

SPS OVERVIEW: REQUIREMENTS, ALTERNATIVES, AND REFERENCE SYSTEM
L. E. Livingston
NASA/Johnson Space Center - Houston, Texas 77058

Any major new source of energy should satisfy several requirements. It should be non-depletable with a large positive energy payback over its useful life, capable of base-load operation and have no fundamental constraint on capacity. It should be compatible with power grids, economically competitive and environmentally acceptable. It should not make excessive use of critical resources, and should be capable of development with reasonable cost, time and risk. The SPS appears to be capable of meeting all of these requirements.

Several power generation options were considered, including silicon, gallium arsenide and thin film photovoltaics, solar/Brayton and solar/Rankine cycle thermal engines, solar/thermionic and nuclear/Brayton. Of these, the last two were rejected early because of large mass penalties relative to the other systems. The helium Brayton and potassium Rankine systems are nearly competitive in mass and cost with the photovoltaic options, but the Brayton cycle achieves competitive mass only at very high turbine inlet temperatures which require advanced ceramic materials not appropriate for reference system use. The potassium Rankine cycle is an acceptable alternative to photovoltaic systems, but was not selected as the reference system because of turbomachinery and radiator maintenance questions and difficulty of construction relative to the photovoltaics.

Some thin film photovoltaic systems may be competitive if sufficiently high efficiencies can be achieved; some present resource problems. The candidate reference systems were thus reduced to silicon and gallium arsenide. A sunlight concentration ratio (CR) of 2 reduces the cost and weight of a gallium arsenide system but is not effective for silicon. Gallium arsenide at CR2 is substantially lighter than silicon at CR1, but presents technology and availability problems. Pending resolution of these questions, both systems are retained as reference systems.

For RF generation, the klystron is preferred to the amplatron because of higher gain, lower noise and higher output per tube. The magnetron appears interesting but has not been investigated in depth. Solid-state RF generators offer several advantages; they are discussed in a subsequent paper. A slotted waveguide array is the preferred type of radiating element based on high efficiency, simplicity and few unknowns. The waveguides are assembled into 10 m x 10 m subarrays for minimum mechanical and electronic complexity.

A wide variety of transmitter power density tapers has been studied. A ten-step 10 dB Gaussian taper has been selected for the reference system as a good compromise between peak power density, sidelobe levels and mechanical complexity. The reference system employs a retrodirective phase control system, although ground command and hybrid systems are promising alternatives.

The reference rectenna consists of dipole receiving elements and Schottky barrier diodes on panels normal to the microwave beam, with power distribution and conditioning equipment for the required interfaces with the power grid. Other concepts, such as waveguides or parabolic concentrators, may offer advantages but appear to be too costly.

A reference set of efficiencies has been defined that represents reasonable goals for each step in the power conversion-transmission-reception chain (see figure 1). These efficiencies imply a power density limit of 21 kW/m^2 at the transmitter which, together with a limit of 23 mW/cm^2 at the ionosphere and the reference antenna taper, leads to a maximum power of 5 GW per microwave link delivered to the power grid. This is the value selected for the reference system. There is recent evidence that 23 mW/cm^2 may be conservative; if so, the maximum power per link could be increased.

A geostationary orbit, with zero eccentricity and inclination, is preferred on an overall basis, although a few other orbits offer some specific features that could prove to be advantageous. Solar radiation pressure is the dominant perturbative force, requiring on the order of 50 tonnes of propellant per year if eccentricity is to be held at zero. By differential thrusting, this orbit-keeping impulse can also be applied to altitude control, which would otherwise require nearly as much propellant itself.

A major consideration in selection of the reference configuration (figure 2) was ease of construction. The scale of the program mandates the highest possible degree of automation in the construction process; this in turn places a premium on highly regular configurations that can be constructed with a small number of frequently repeated operations. Ease of construction was, for example, one consideration in the selection of an end-mounted, rather than central, antenna.

The reference system is constructed in synchronous orbit using material transported from low earth orbit by electric orbit transfer vehicles. Construction in low orbit of sections of the satellite with subsequent self-powered transfer to synchronous orbit for assembly is an alternate approach.

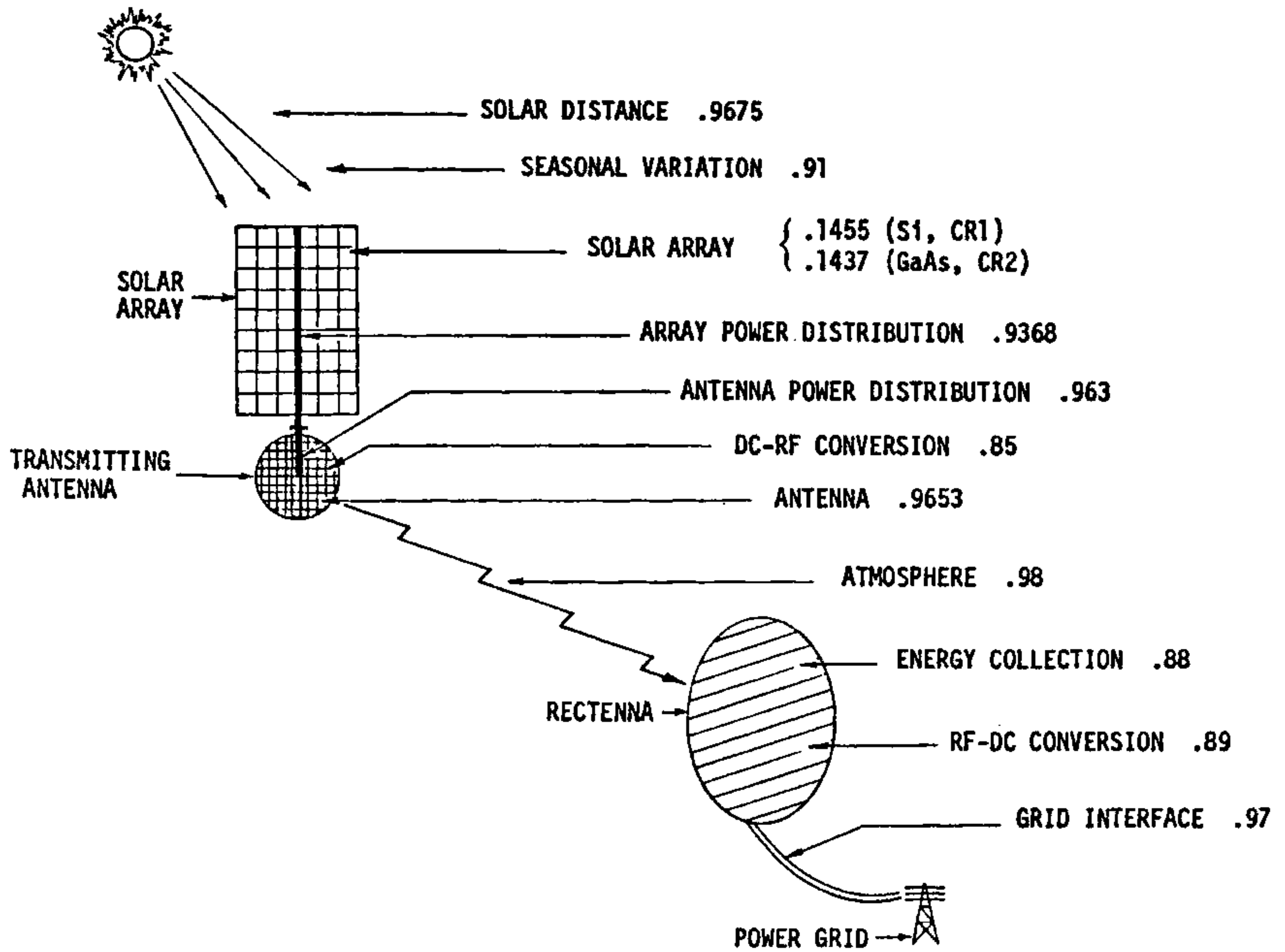

93

Figure 1. Reference Efficiency Chain

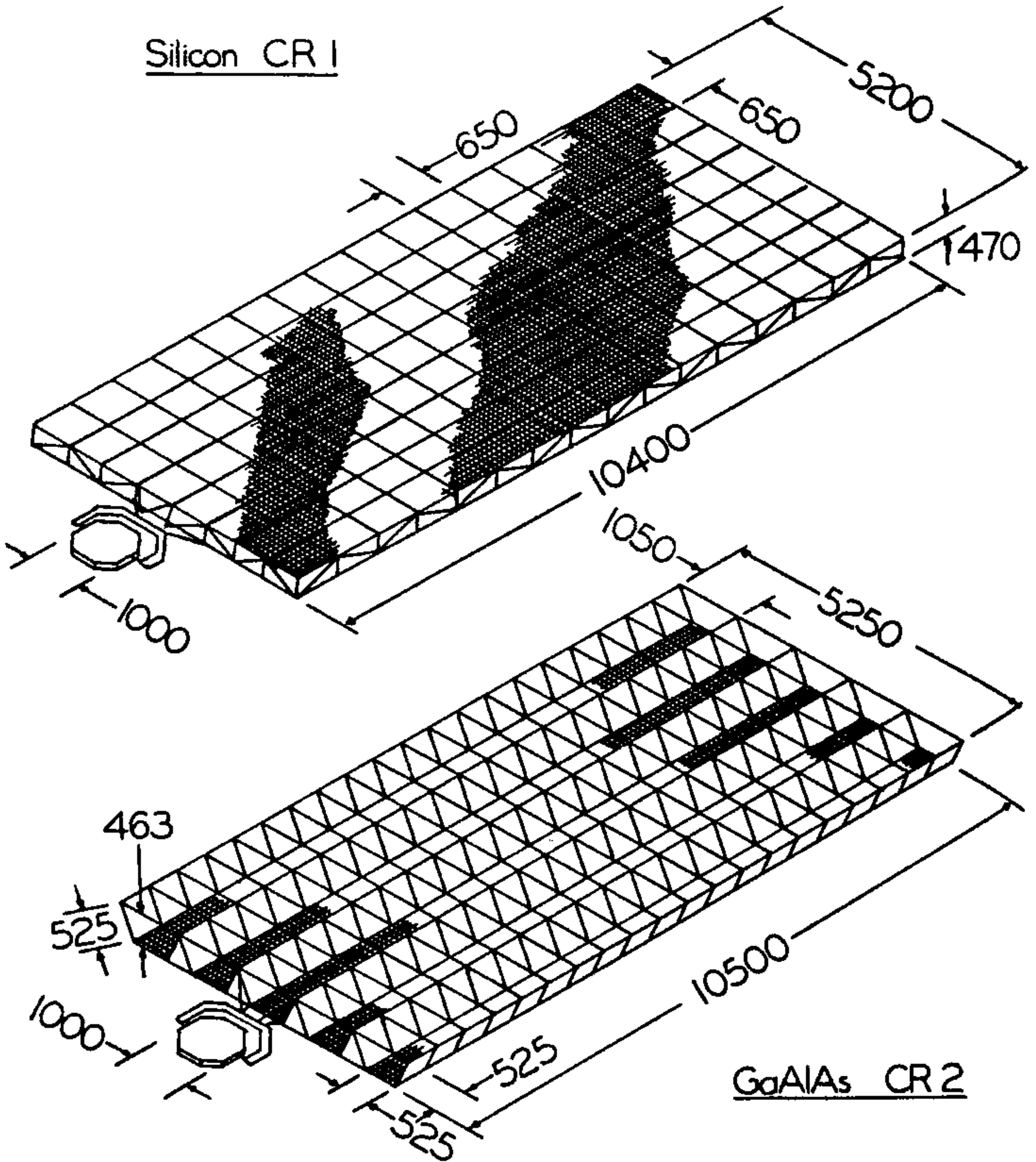

Dimensions in meters

Figure 2. Reference Configurations

EMERGING SPS CONCEPTS
by G.M. Hanley, Rockwell International
G.R. Woodcock, The Boeing Company

Four new technologies have recently been evaluated to determine their effect on Satellite Power System (SPS) concepts. Two of these technologies, solid-state power amplifiers and magnetrons, are replacements for the klystrons used for dc to RF conversion on the satellite. A third technology, laser power transmission, transmits the energy at laser frequencies rather than microwave frequencies. The fourth technology, multibandgap solar cells, has the promise of significantly increased solar to dc conversion efficiency as compared to the reference-concept silicon and gallium arsenide solar cells. This paper summarizes the design characteristics of concepts resulting from application of these technologies.

One of the solid-state microwave concepts, shown in Figure 1, has a configuration similar to the reference concept, although this concept has two end-mounted antennas rather than one. Solar energy is collected in the same manner as it is on the reference satellite and is conducted to the attached microwave antenna using a modified power distribution system. Because of a lower operating temperature requirement for the solid-state amplifiers (compared to klystrons), larger antennas are needed that produce less power at the utility interface than the reference concept (2.6 GW per antenna compared to 5.0 GW). Although the concept shown in Figure 1 uses a concentrated GaAs solar array, a nonconcentrated silicon solar array also could be employed and would have a similar collector area. The antenna configurations for this concept are quite different from the reference klystron design because of the large number of solid-state power amplifiers needed to provide the RF power compared to klystrons (5-10 watts per amplifier for solid state compared to 50-70 kilowatts for klystrons). The major problem, however, is distribution of power from the solar array to each of the power amplifiers. Feed voltages for the solid-state amplifiers is ten volts compared to voltages for the klystron that vary from 8,000 volts to 40,000 volts. One approach proposed by Rockwell to alleviate this problem employs a combination of series/parallel strings of power amplifiers to achieve higher module voltages along with two-step dc/dc power conversion on the antenna to transform from high voltage from the solar array (40,000 volts) to the string voltage (640 volts). The resulting system requires advanced technology dc/dc converters with masses of 0.27 kg/kW. An alternate approach proposed by Boeing utilizes parallel/series strings up to very high voltages (e.g., 5500 volts) with direct power from the array.

A solid-state sandwich concept, shown in Figure 2, overcomes the power distribution problems of the previously described solid-state concept by putting the microwave antenna and power amplifiers directly behind the solar array in a "sandwich" configuration. Since the antenna must constantly be pointed at a receiving site on the ground, the sun must be reflected onto the array with a two-reflector

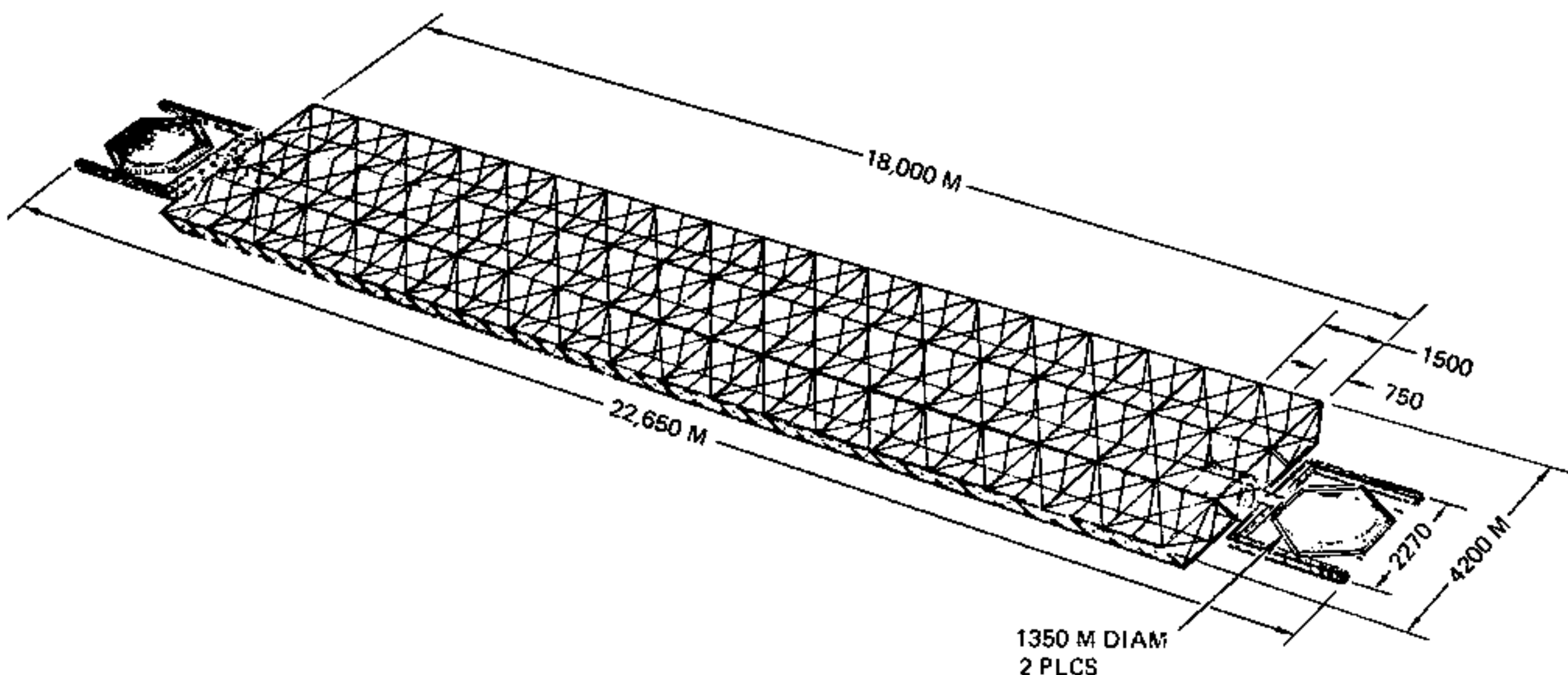

Figure 1 Solid-State End-Mounted Antenna Satellite Concept

system. The secondary reflector is fixed to the sandwich array, while the primary reflectors point at the sun continuously. Although the reflector area is large, the reflector mass is low since it is fabricated from 1/2 mil aluminized kapton. The concept as illustrated in Figure 2 has two microwave antennas, each of which transmits 1.2 GW of power to the utility interface on the ground. This concept is not practical with silicon solar cells because it is necessary to have concentrated sunlight (5.2 suns in this concept) on the solar cells to provide adequate power density to the transmitters. Either GaAs or multibandgap solar arrays are feasible under these conditions.

The sandwich panel concept designed by Rockwell is shown in Figure 3. The solar array is bonded to a fiber honeycomb core. The back of the solar array serves as a ground plane for the power amplifier drive distribution system located midway through the honeycomb core. Another ground plane is located on the other side of the sandwich. This ground plane serves both the amplifier drive system and the transmitter. The honeycomb core assembly is attached to a truss structure that supports the antenna and power amplifiers. The power amplifiers are shown mounted at the front of the truss structure to beryllium oxide wafers that dissipate waste heat from the amplifiers. A single amplifier drives each dipole. The total mass per unit area of the sandwich is only 1.68 kg/m²

Magnetrons appear to have significant advantages compared to klystrons, including increased lifetime (up to 30 years compared to ten years for klystrons between replacements), a single rather than multiple operating voltages (thus eliminating dc/dc conversion), a simpler waste heat rejection system (use conduction/radiation of heat rather than heat pipes and radiators), and possible a higher dc/RF conversion efficiency (e.g., 90 percent compared to 85 percent). The resulting design concept is shown in Figure 4. Although the satellite appears very similar to the klystron reference concept, there are some significant differences. Power at the utility interface is 5.6 GW compared to 5.0 GW for the reference concept. The mass is only 26.7 million kg compared to 31.6 million kg for the reference concept.

Table 1 compares some of the most significant characteristics of the above described concepts. As indicated, the magnetron concept has much lower specific mass compared to the reference concept, the solid-state end-mounted antenna concept has higher specific mass, and the solid-state sandwich concept, using multibandgap solar cells, has a specific mass that is similar to the reference concept using multibandgap solar cells. The multibandgap solar cells significantly reduce specific mass. They are particularly effective on the sandwich concept in this regard.

Laser power transmission concepts have not yet been defined to the level of detail of microwave concepts. The Boeing Company is currently conducting initial studies of this concept. Three approaches are being considered: electric discharge, solar pumped, and free-electron lasers.

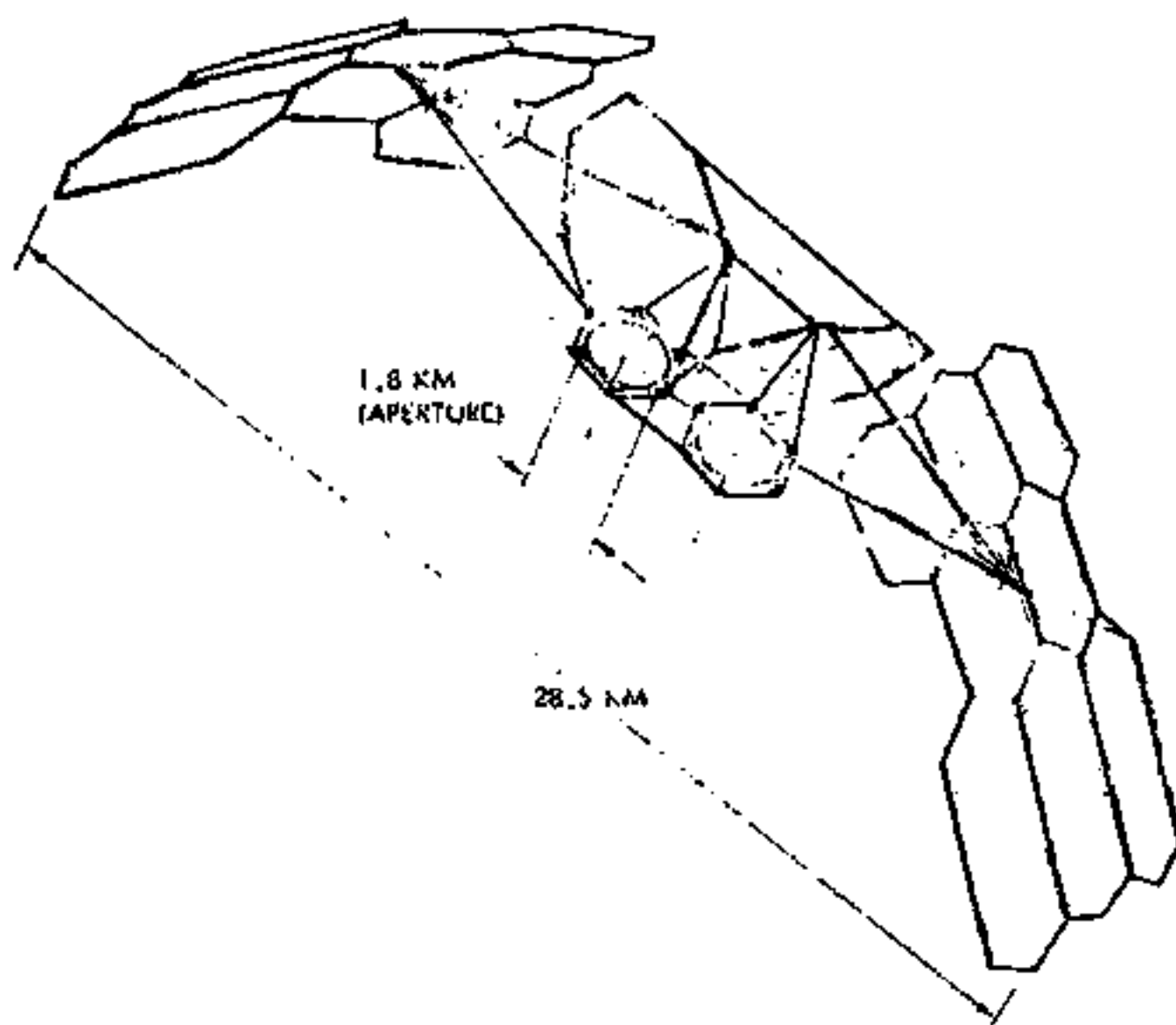

Figure 2. Solid-State Sandwich Satellite Concept

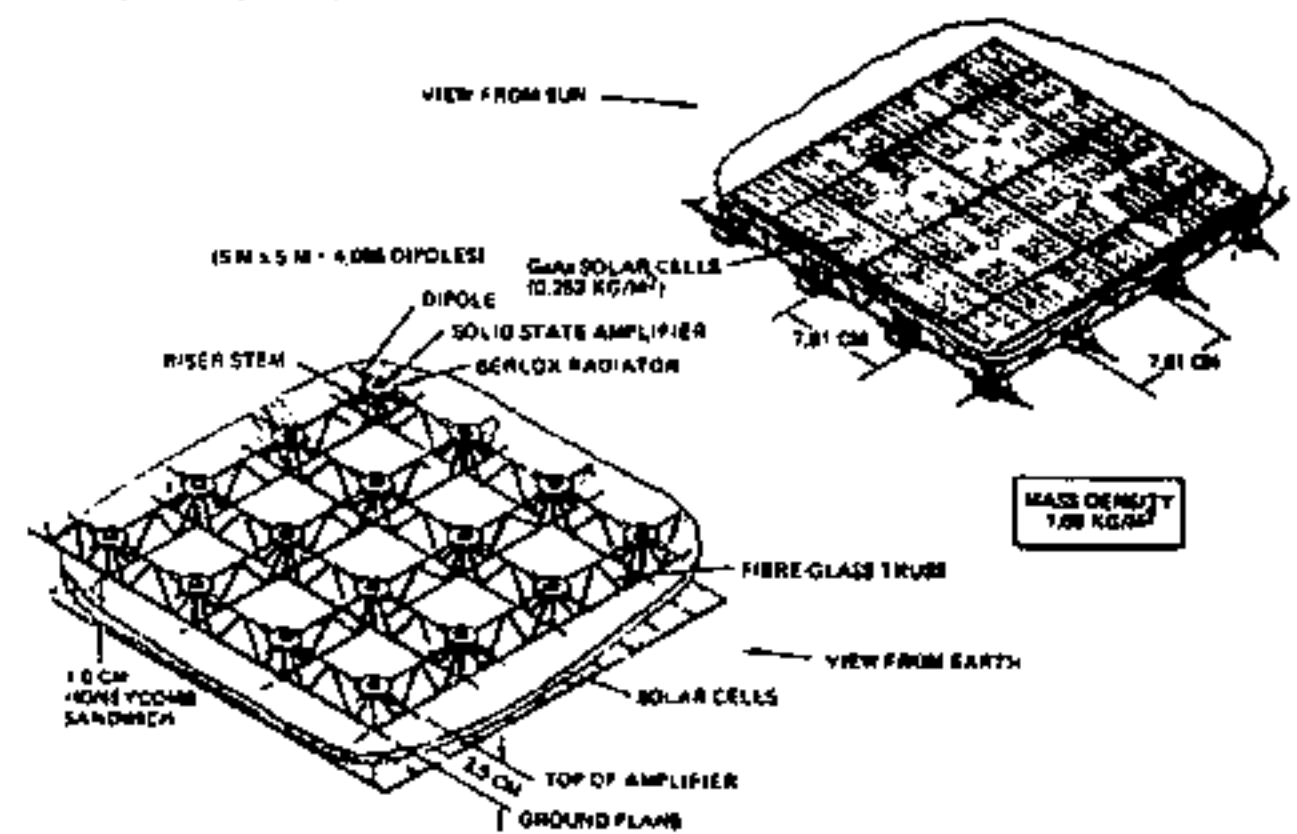

Figure 3. Solid-State Sandwich Design

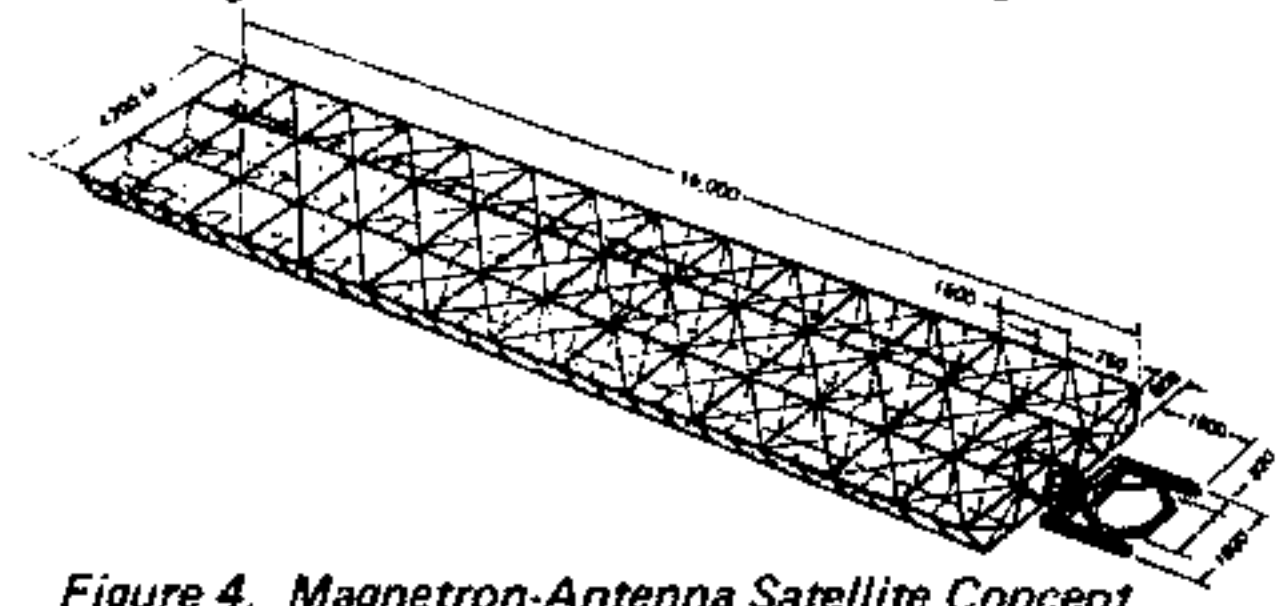

Figure 4. Magnetron-Antenna Satellite Concept

Table 1. Concept Comparisons

	REFERENCE CONCEPT		MAGNETRON CONCEPT		SOLID-STATE END-MOUNTED CONCEPT		SOLID-STATE SANDWICH CONCEPT	
	GaAs	MBG	GaAs	MBG	GaAs	MBG	GaAs	MBG
TYPE OF SOLAR ARRAY	GaAs	MBG	GaAs	MBG	GaAs	MBG	GaAs	MBG
EFFECTIVE CONCENTRATION RATIO	1.83	1.83	1.83	1.83	1.83	1.83	5.2	5.2
MAXIMUM TRANSMITTED POWER DENSITY (kW/m ²)	21	21	28	28	6.6	6.6	0.70	1.1
ANTENNA POWER TAPER (dB)	10	10	10	10	10	10	0	0
TRANSMITTING ANTENNA APERTURE (km)	1.0	1.0	0.92	0.92	1.4	1.4	1.8	1.6
RECTENNA BORESIGHT DIAMETER (km)	10.0	10.0	11.0	11.0	7.5	7.5	4.8	5.4
POWER AT UTIL. INTERFACE/SATELLITE (GW)	5.0	5.0	5.6	5.6	5.2	5.2	2.4	3.0
POWER AT UTIL. INTERFACE/ANTENNA (GW)	5.0	5.0	5.6	5.6	2.6	2.6	1.2	1.5
SATELLITE MASS (10 kg)	31.6	26.0	26.7	21.5	40.0	35.6	20.5	16.4
SATELLITE SPECIFIC MASS (kg/kW)	6.2	5.1	4.8	3.8	7.7	6.8	8.5	5.40

Electric discharge lasers require electric power to drive a high-voltage discharge that pumps the laser medium to an excited discharge state and to circulate the lasant through a cooling loop to remove waste heat. For this type of system, a solar array may be employed to produce the power. This type of system is extremely inefficient, resulting in a large solar array and large radiators. The result is a system mass and cost that is not competitive with microwave power transmission systems.

Direct solar-pumped lasers also are inefficient because of the narrow lasant spectral band and the broad spectral characteristics of solar energy. For this reason, an indirect solar-pumped approach is used to achieve more compatible spectral characteristics. Solar energy is focused by reflectors into a cavity collector (Figure 5). A temperature is achieved in this cavity that releases thermal radiation in the spectral region that excites the lasant. Efficiencies of this system are considerably improved.

The final laser system, the free-electron laser, is shown in Figure 6. In this concept, an electron beam is formed (using a klystron as the electron source, which is accelerated in an RF accelerating cavity) that produces laser frequency energy upon passing through a magnetic field that causes lateral electron movement. The beam is directed to mirror assemblies on each end of the satellite that form a laser beam which is directed to a receiving station on the earth. The solar array provides the energy that powers the system. The system on the ground for conversion of laser to electrical energy uses optical diodes that are analogous to the microwave rectenna. Conversion efficiencies are similar to the rectenna system. This system appears to provide the highest efficiency and lowest mass of all laser systems studied.

Figure 7 compares the specific masses of the laser concepts and the reference silicon solar array concept that uses klystrons for dc/RF microwave conversion. Current estimates made by the Boeing Company indicate that the lowest mass laser concept (free-electronic laser) is about twice the specific mass of the reference concept.

Additional effort remains to be accomplished to evaluate and compare these concepts. Even lower mass and cost solid-state antennas need to be developed because of the importance of antenna mass on the cost of these concepts. Device development also must proceed to ensure that the requirements can be met. Magnetron concepts appear to have the best combination of characteristics, but development is needed to determine whether predicted lifetime and efficiency goals can be obtained. Because of the obvious advantages of multibandgap solar arrays in improving system

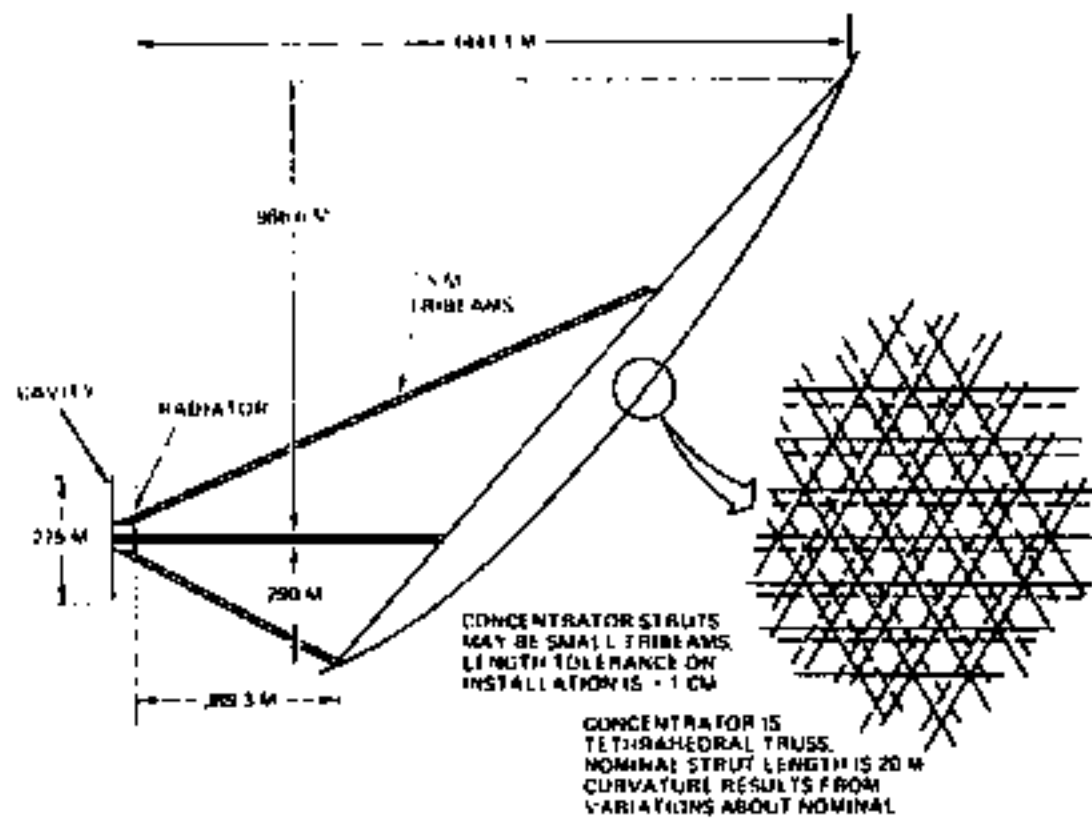

Figure 5. Indirectly Optically Pumped Laser SPS General Arrangement

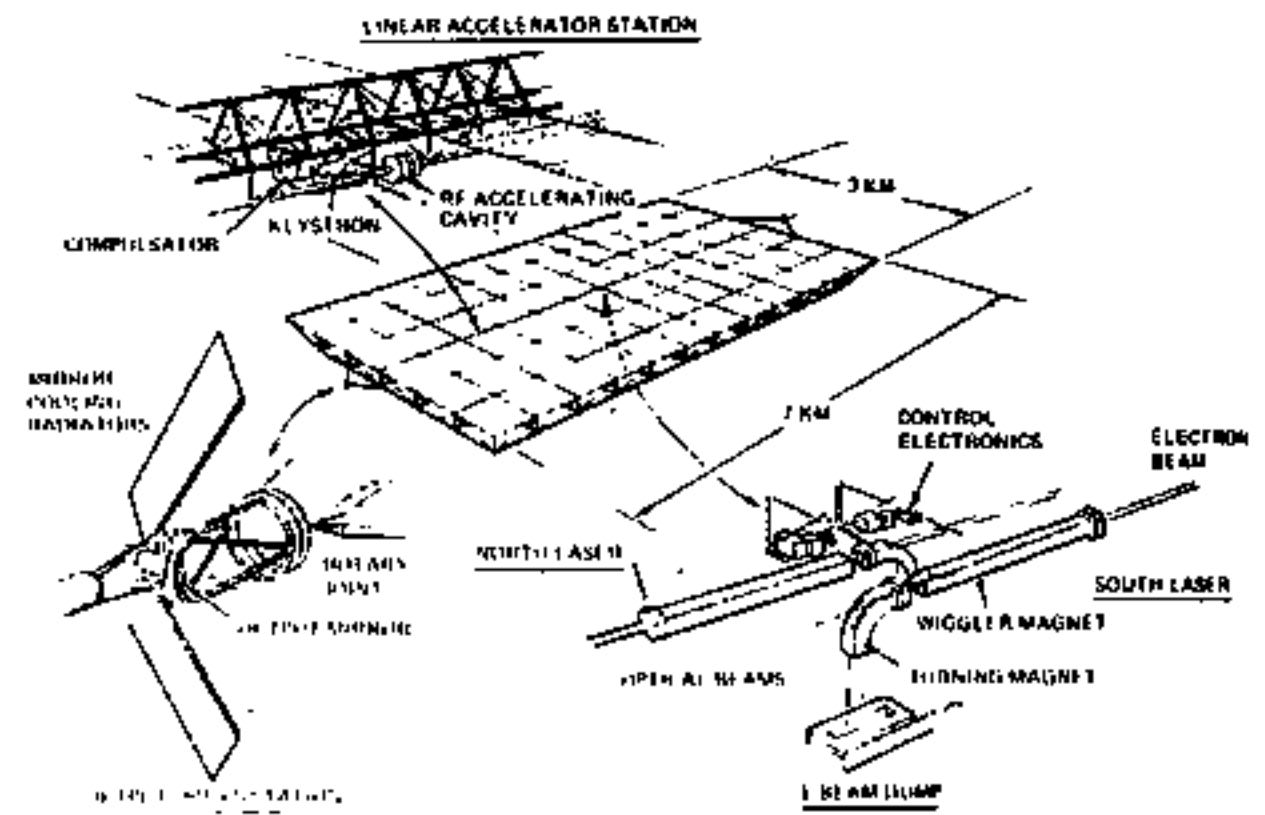

Figure 6. 1-GW Single-Pass Free Electron Laser SPS

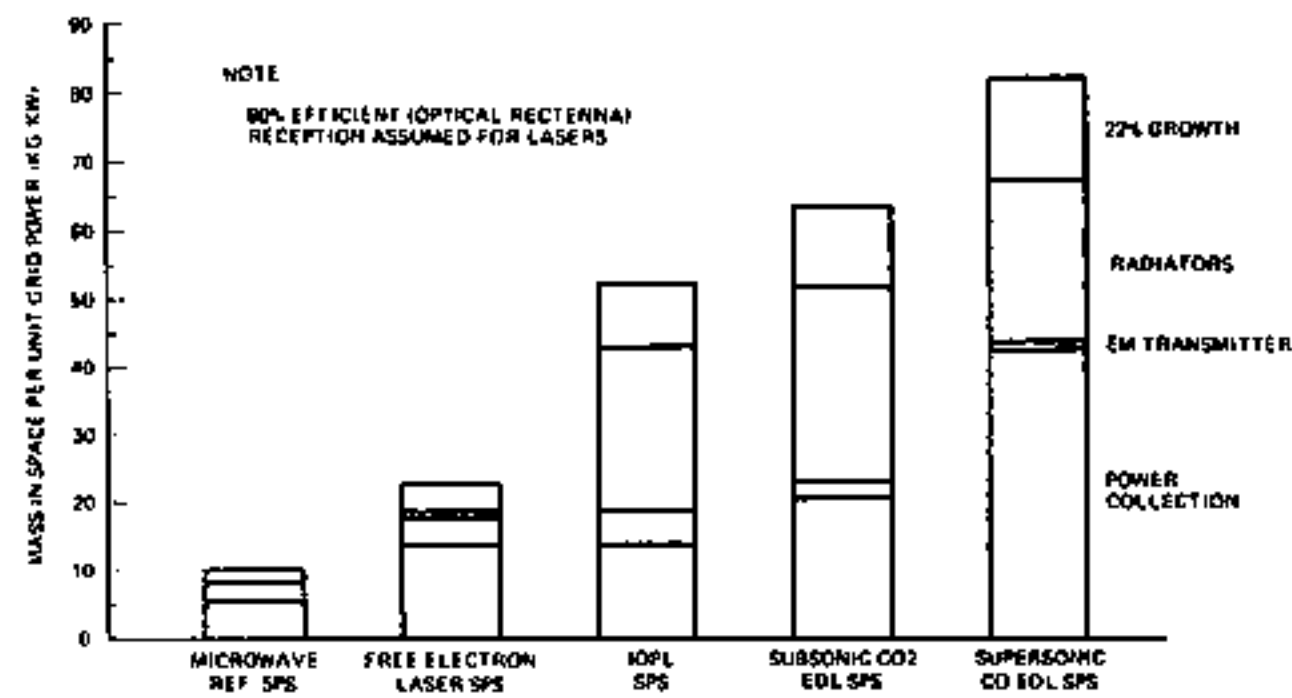

Figure 7. Comparison of Laser Options and Reference SPS Concept

efficiency, research leading to cells with the desired high efficiencies with little increase in cost and mass is needed. Additional laser systems studies are needed to determine approaches that may lead to reduced mass and cost to make them more competitive with the microwave SPS concepts. In addition, because of the problems related to penetrating heavy cloud layers, total power system integration studies are needed to determine the degree to which a laser system might penetrate the utility network.

INTEGRATION OF SPS WITH UTILITY SYSTEM NETWORKS

Bjorn M. Kaupang
General Electric Company

Introduction

This paper will discuss the integration of SPS power in electric utility power systems. Specifically treated will be the nature of the power output variations from the spacecraft to the rectenna, the operational characteristics of the rectenna power and the impacts on the electric utility system from utilizing SPS power to serve part of the system load.

Dynamic Power Variations in the SPS System

As a first approximation the SPS system consists of a constant power source working into a constant load. However, in practice the available power degrades slowly over the 30 year lifetime and it is modulated by infrequent but relatively rapid fluctuations.

Table 1 lists some of the conceivable sources of relatively rapid power variations in the SPS system. They are listed approximately in sequence of the associated total yearly loss of energy.

It can be seen that among the listed items only the first two, maintenance and eclipse produce 100% outage and both of these fall into the scheduled down time category. These two sources cause scheduled down times of 1.36% and 1% respectively. The remaining effects are small and essentially random. Total energy loss is less than 2.7% per year if shut down and start up times associated with eclipses are also considered.

When it is necessary to implement scheduled or unscheduled output power level variations from the spacecraft several methods can be considered.

Table 2 shows 7 methods to control the power input into the rectenna. Reduction of power to zero will require a maximum .45 sec.

Rectenna Inverter Control and Operation

The power conditioning system that has been recommended for the SPS is the current fed, line commutated inverter. This type of system is in common use in HVDC power transmission. Synchronous condensers control the ac voltage and the supply of reactive power.

The SPS should operate at full available output. To accomplish this, the inverter must present to the rectenna the optimum load impedance. It is assumed that the rectenna is basically resistive in nature and there is an optimum dc load resistance for maximum power transfer.

Normally the system would be operated at optimum resistance so that the rectenna would reflect a minimum of power. The power level would be adjusted at the satellite and would usually be set at maximum available power. If power reduction is required by utility considerations and it could not be accomplished at the satellite, the converter power can be adjusted by means of moving the resistance off optimum. Of course, RF power would be reradiated but that might be acceptable under the circumstances.

The converter module requires reactive power from the ac bus in approximate proportion to the active power being delivered to the utility network. This reactive power is supplied by static capacitors, harmonic filters and synchronous condensers.

Performance during the semi-annual eclipse periods can be made largely automatic. As RF power decreases during the partial eclipse period the converter, through its constant resistance load characteristics, will track the rectenna output and provide available power. The principle problem during these eclipse periods will be power dispatch in the ac system to preserve load and frequency. A mitigating factor will be that the power loss occurs at night when the ac system is most able to cope with it.

SPS Operating Characteristics

Currently accepted response characteristics for electric utility system generating plants and measures of utility system reliability have been the basis for the integration of SPS power with electric utility systems.

Two of the power control methods, 2 and 4, described in Table 2 were deemed practicable and acceptable by utility system criteria. The response times and power control range for these two methods are compared with conventional generating unit characteristics in Figure 1. It is seen that the SPS response in both cases is better than that of conventional generation.

The SPS is unlike conventional generation in that it has no mechanical inertia and hence appears as a negative load to the system. Control of the incident power will be at the satellite antenna via communications link and this control loop, involving transmission of control signals through space, is the nearest analog of governor control of a conventional generation source.

The study of impacts on system reliability adding SPS generation to electric utility systems was based on a reliability model for SPS as shown in Figure 2. These probability plots were developed using the information in Table 1 combined with a failure analysis of the rectenna system. These curves, however, are too complex to be used directly in current utility system reliability planning models. A simplified 5-state outage model was used in a parametric approach to determine the impact of SPS power on utility system reserve levels for various amounts of SPS penetration. The results of this investigation are shown in Figure 3.

Conclusions

The results indicate that if RF beam control is an acceptable method for power control, and that the site distribution of SPS rectennas do not cause a very high local penetration (40-50%), SPS may be integrated into electric utility system with a few negative impacts. Increased regulating duty on the conventional generation, and a potential impact on system reliability for SPS penetration in excess of about 25% appear to be two areas of concern. Assessment of more detailed models and advanced design parameters for the SPS system must be done before it would be possible to investigate the SPS/Utility System integration in more detail.

NO.	SOURCE OF POWER VARIATION	RANGE %	FREQUENCY OF OCCURENCE PER YEAR	AV. DURATION OF OUTAGE PER OCCURENCE MIN/YEAR	TOTAL OUTAGE HR./YEAR	MAX. POWER REDUCTION GW	AV. YEARLY ENERGY LOSS GW HR.	TIME TO MAX POWER LOSS	SCHEDULED YES NO
1.	SPACECRAFT MAINTENANCE	0-100	2	2 x 3600	120	5	600	6 MIN	X
2.	ECLIPSE	0-100	62	3376 TOTAL 71 MAX PER/ OCCURENCE	56.26	5	261.3	1 MIN	X
	ECLIPSE WITH SHUTDOWN AND STARTUP			5270	67.8		439	1 MIN	X
3.	WIND STORM	75-100	0.01	5260	67.6	1.25	106.5	5 MIN	X
4.	EARTHQUAKE	90-100	0.01	1800	30	0.5	15	10 SEC	X
5.	FIRE IN REC-TENNA SYSTEM	80-100	0.01	840	14	1	14	30 MIN	X
6.	METEORITE HIT OF SPACECRAFT EQUIPMENT	90-100	0.01	1200	20	0.5	10	100 MS	X
7.	RECTENNA EQUIPMENT FAILURE	91.5-100	1	50	0.833	0.425	0.35	100 MS	X
8.	PRECIPITATION	93.3-100	50	1	0.833	0.335	0.28	1 M	X
9.	POINTING ERROR	94.8-100	5000	0.6	0.833	0.29	0.24	1 S	
10.	IONOSPHERE	98.5-100	20	10	3.32	0.15	0.24	1 S	X
11.	GROUND CONTROL EQUIPMENT FAILURE	95-100	5	3	0.25	0.25	0.06	0.3 S	X
12.	AIRCRAFT SHADOW	99.99-100	20	20 M 1 M MAX/ OCCURENCE	0.3	0.0005	0.0015	1 S	X

TOTAL WITHOUT SHUTDOWN/STARTUP: 331 HR (3.77%) 1030.8 (2.35%)
WITH SHUTDOWN: /STARTUP: 362 HR (4.12%) 1188.5 (2.71%)

Table 1. Characteristics of Available Power Variation in SPS System

METHOD	EFFECT ON LIFETIME	RANGE OF POWER	TIME DELAY	ON	OFF	WHERE THE POWER GOES	ENERGY REQUIREMENT
1. REDUCE KLYSTRON BEAM VOLTAGE	SMALL	100-80	300 MS	X		THERMAL RADIATION ON SPACECRAFT	NONE
2. INTRODUCE QUADRATIC PHASE ERROR TO ANTENNA APERTURE	NONE	100-50	300 MS	X		INCREASES POWER AROUND RECTENNA. (~ 14 KM)	NONE
3. RANDOMIZE ANTENNA PHASES	NONE	100-0	450 MS	X		INTO 1000 KM DIA. FOOT-PRINT	NONE
4. TILT OF ANTENNA PHASE	NONE	100-0	1 SEC.	X		OFF EARTH	NONE
5. TILT OF ANTENNA	MODERATE	100-0	216 S	X		OFF EARTH	MODERATE
6. DISCONNECT KLYSTRON RINGS		100-0	3 S		X	AROUND RECTENNA	NONE
7. TILT SOLAR ARRAY AND 6	LIFE OF SLIP RING	100-0	131 MIN.		X	TO UNIVERSE	LARGE

Table 2. Various Methods to Reduce Power Into Rectenna

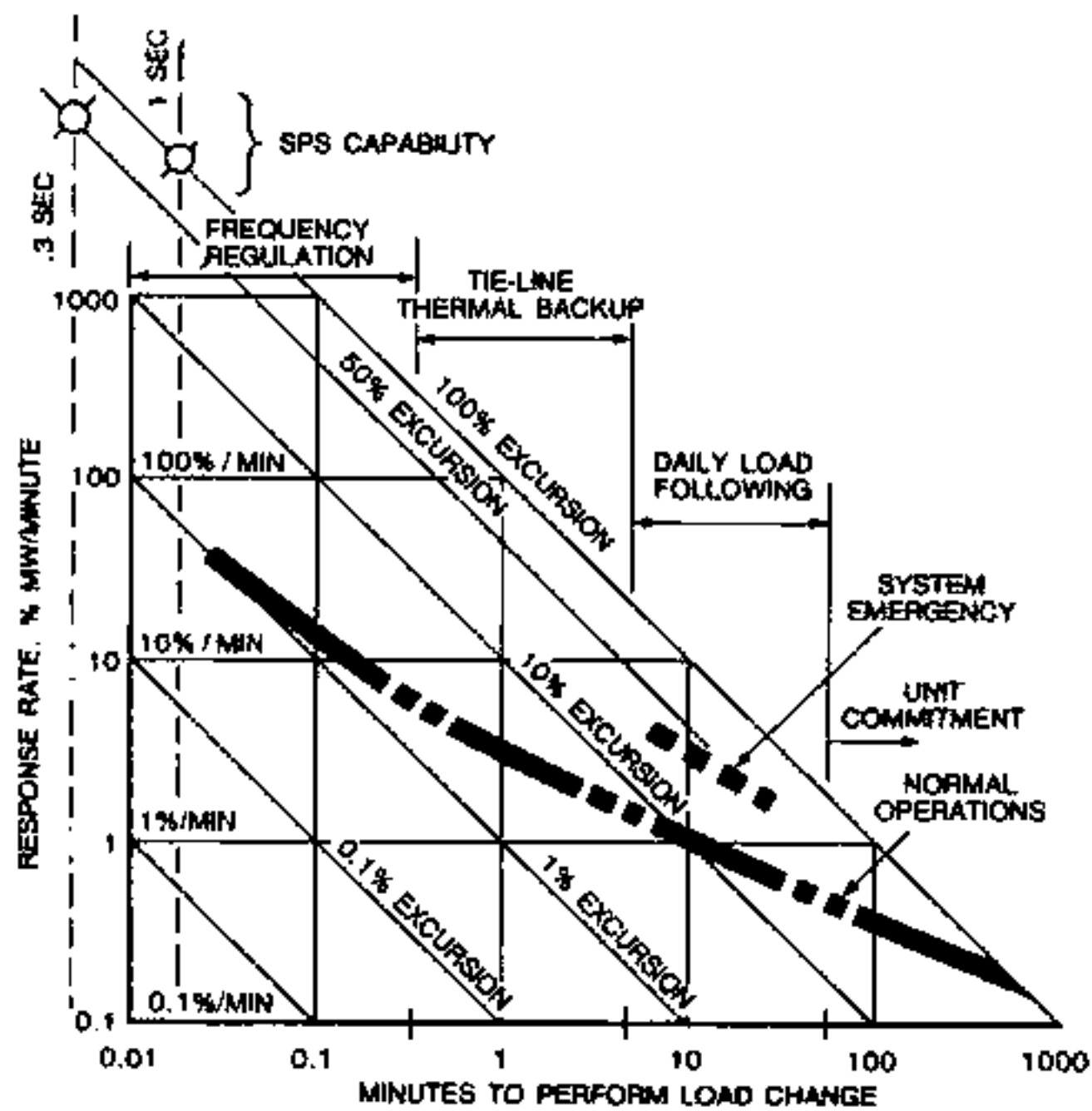

Figure 1. SPS Response Capability Compared with Conventional Generating Units

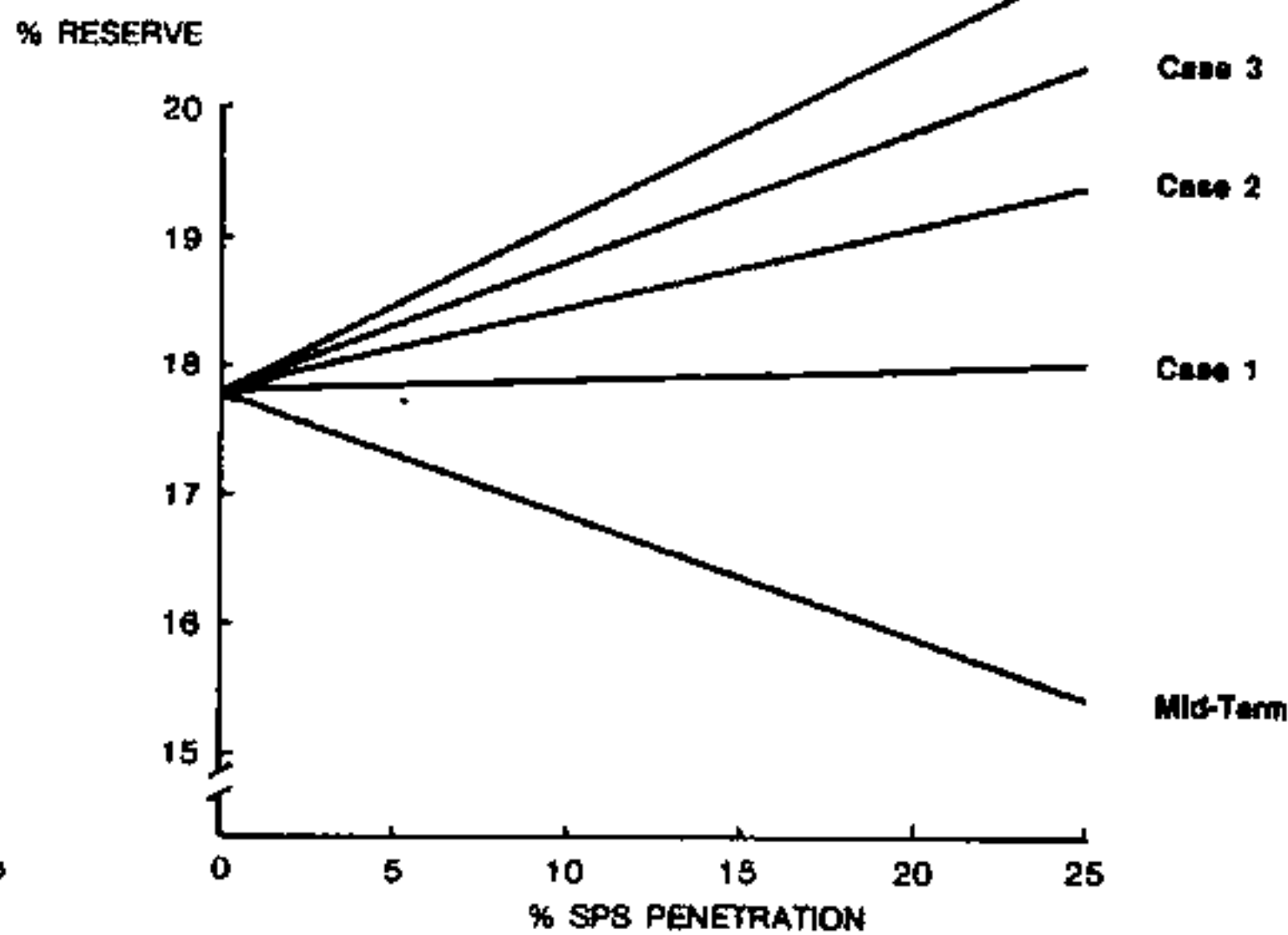

Figure 3. Utility System Reserve Levels vs. SPS Penetration

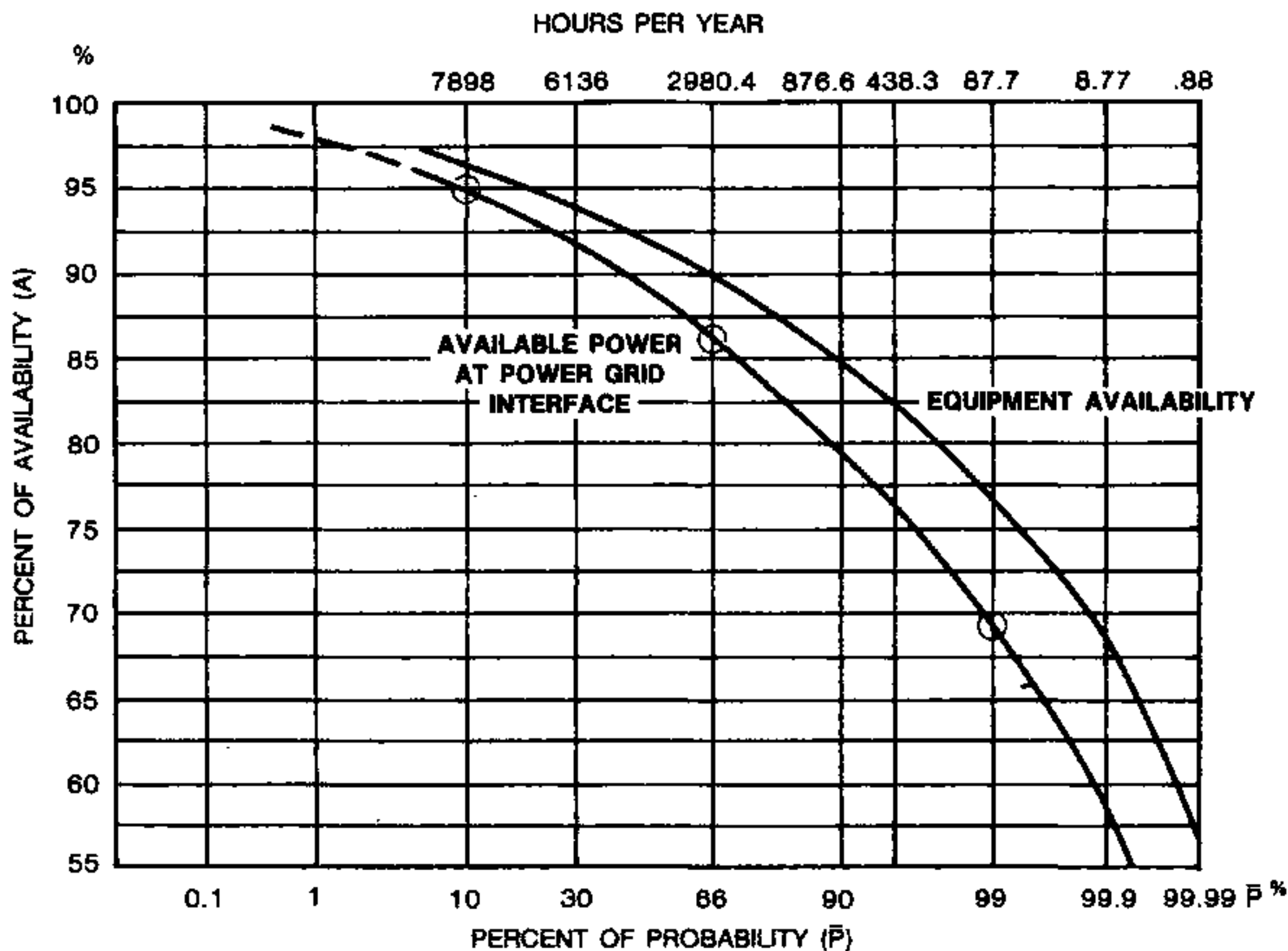

Figure 2. Utility System Reliability SPS Reliability Model

SPS COST METHODOLOGY AND SENSITIVITIES

Robert O. Piland
Lyndon B. Johnson Space Center
National Advisory Committee for Aeronautics
Houston, Texas

INTRODUCTION

Accurate cost estimates for any advanced energy system are very difficult to develop. All such estimates require assumptions related to technological advancement over an extended period of time. Nevertheless, the evaluation of a potential system requires such estimates, and a number of cost estimates have been developed during the Solar Power Satellite (SPS) Concept Evaluation Program. The present summary paper will describe one such estimate for illustrative purposes. It should be noted that no official cost estimate exists for an SPS program at the present time.

Cost estimates for advanced systems must be considered from two perspectives. The first is the cost to achieve the initial operational unit. This cost includes research, engineering, demonstration, industrial and operational facility development, as well as the hardware and construction costs of the initial operating unit. The second is the cost to replicate the initial unit. The replication cost may vary as learning continues and productivity increases.

For the purpose of estimating costs, assumptions are required. The reference system as described in reference 1 serves as a general basis for the present estimate. Primary elements of the system are depicted in figure 1. These include the energy system consisting of the satellite and ground-receiving station or rectenna, a space construction facility located in geosynchronous orbit and a staging base located in low earth orbit; and a cargo launch vehicle and a cargo orbital transfer vehicle. Other system elements include personnel launch and transfer vehicles, launch and recovery facilities, and earth-based production facilities. Each satellite is designed to deliver 5 gigawatts of power to an electrical utility network, and two satellites are assumed to be constructed each year for a period of 30 years resulting in a generating capacity of 300 gigawatts.

The program is assumed to consist of a number of phases. Each phase represents an increasing commitment of resources as confidence in the ultimate success of the program grows. The phases may be implemented serially although a degree of overlap may represent the most effective approach.

Reference 1. Reference System Report, Satellite Power System Concept Development and Evaluation Program, U.S. DOE and NASA, October 1978.

Figure 1

NASA

**Solar Power
Satellite**

**Major Program
Elements**

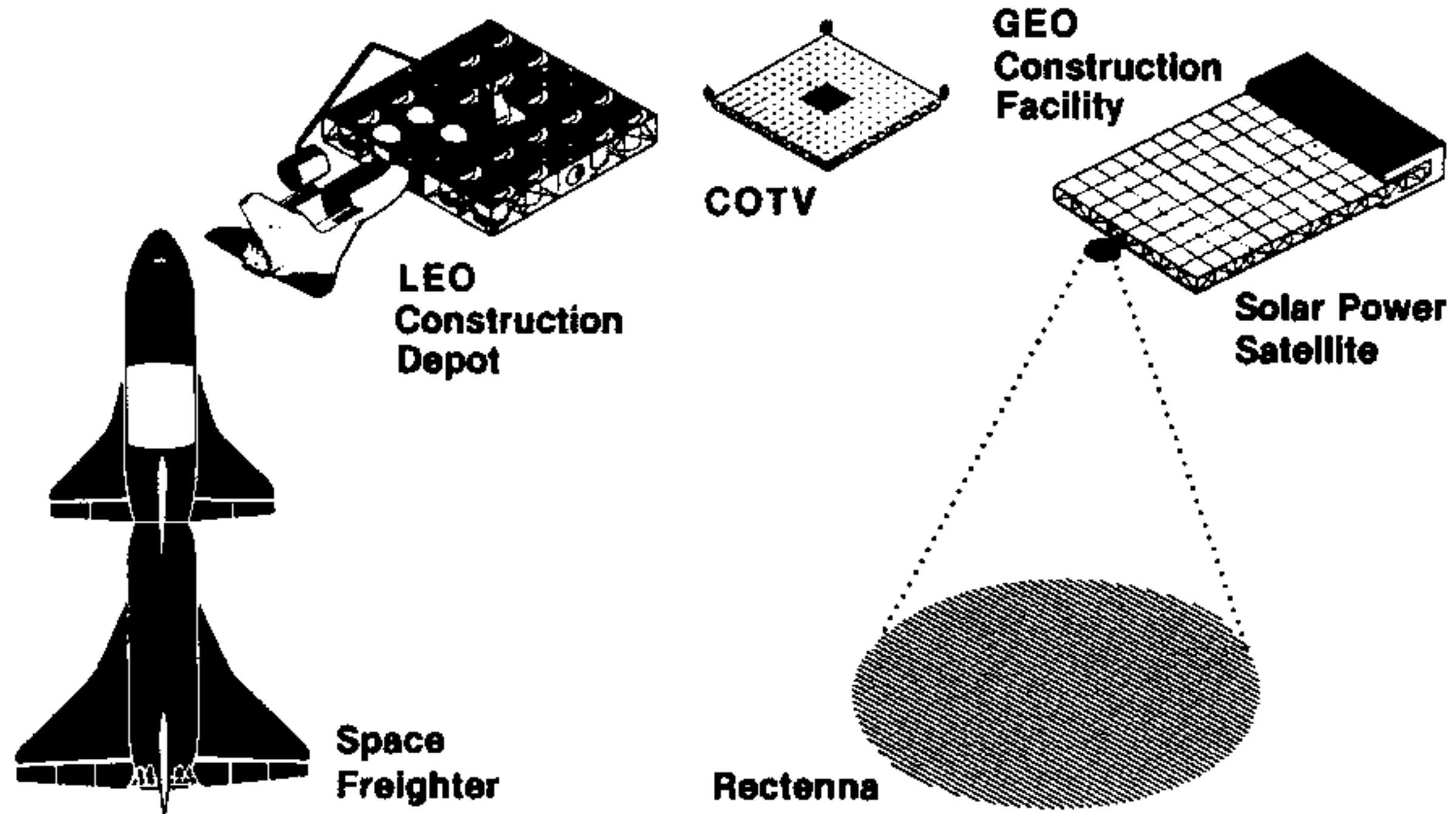

Program Cost Estimates

The program phases with an estimated cost for each phase are presented in Table 1.

<u>Table 1. Solar Power Satellite Program Cost Scenario in Billions of 1977 \$</u>	
<u>Phase</u>	<u>Cost</u>
Research	.4
Engineering	8.1
Demonstration	23.0
Investment	57.5
First Unit	<u>13.5</u>
Total	102.5
Average Unit	11.5

It should be noted that the cost of the necessary environmental research program and social and economic studies are not included in Table 1. These costs would not affect the total cost nor the average unit cost to any great extent. They could, however, add significantly to the research phase of the program.

The total cost of the program through the first full-scale unit is estimated to be slightly over 100 billion dollars. The subsequent fifty-nine units are estimated to cost an average of 11.5 billion dollars per unit. A general description of each of the phases is given below.

Program Phase Descriptions

The research phase is designed to resolve critical technical issues which have been defined during the concept evaluation program. Approximately one-half of the estimated effort would be expended in ground laboratories and would emphasize such issues as the development of techniques for mass producing solar cells at acceptable costs. The remaining half of the effort would be devoted to specific space experiments which cannot be conducted in the laboratory. High voltage-plasma interaction typify the phenomena which cannot be adequately simulated in the laboratory.

The engineering phase would consist of a number of space projects which would allow the development of space construction techniques and the testing in space of engineering models or prototypes of various subsystems. Major cost elements include a multi-man space operation center in low earth orbit, a manned orbital transfer vehicle, a one megawatt solar array and transmitter, a liquid flyback booster for the Shuttle transportation system, and a number of subsystems such as the electric propulsion units.

The demonstration phase of the program is most difficult to define, and will have to evolve over a period of time. For the purpose of the present estimate, a system capable of delivering 100-200 megawatts of power from geosynchronous orbit to earth is assumed. This phase includes construction and support facilities at geosynchronous and low earth orbit and significant transportation system development and operations.

The investment phase involves the development of the capability to construct full-scale commercial energy systems. It includes the development and purchase of a transportation fleet, a full-scale space construction facility, launch and recovery facilities to handle daily launches, and industrial production facilities to mass produce solar cells, power amplifiers, and other high volume components.

The cost of the first production unit includes the satellite hardware costs (33%), the cost of transporting the hardware to the space construction facility (33%), the cost of space construction (11%), and the cost of hardware and construction of the ground rectenna (22%).

The average unit cost is seen to decrease somewhat after construction of the first unit. This reduction is related to an estimated reduction in space construction costs, as a function of learning, and a reduction in transportation costs.

Concluding Remarks

A total SPS program has been defined and costs for such a program estimated. The scope and complexity of the program, coupled with the necessity of projecting technology over a long period of time obviously limit the accuracy of such an estimate. Despite these difficulties, the cost estimates are useful as a reference for comparison with alternate approaches and as a guide for assessing the relative cost importance of the various program elements and components.

The cost estimates presented in table 1 were obtained from studies conducted by the Boeing Aerospace Company as part of the SPS Systems Definition effort.

SPS TECHNICAL ISSUES
C. H. Guttman
PS01, NASA Marshall Space Flight Center, Alabama 35812

Beginning with the earliest studies of Satellite Power Systems (SPS) engineers and scientists have consciously "red flagged" any technical issue which would either seriously impact or potentially negate the integrity of an SPS Program. Issues were identified not only relating to the question of engineering feasibility, but also to the equally important areas of environmental and social acceptability and, especially, economic viability. Much effort has been expended on studies and experiments directed toward obtaining an understanding of these issues and the degree to which they can be resolved. A lot of people feel that many "show-stoppers" exist which cannot be resolved, or worse, that key technical issues have been ignored. It is the intent here to enumerate technical issues which were highlighted some four years ago; to selectively discuss some of the results obtained as to their resolution; and to briefly touch on their current status.

The table shown below is a composite list of technical issues and program concerns covering the spectrum of SPS activities. A set of criteria was developed as a guide in evaluating the issues. These criteria consisted of categorizing the issues into one of the following three levels of criticality:

- Level 1 - Potential "show-stoppers"
- Level 2 - Potential of serious impact
- Level 3 - Potential of undesirable impact

CRITICALITY	ECONOMIC VIABILITY	TECHNICAL FEASIBILITY	ENVIRONMENTAL ACCEPTABILITY
LEVEL 1— POTENTIAL SHOW STOPPERS (KEY ISSUES)	CAPITAL INVESTMENTS TRANSPORTATION COST TO ORBIT FRONT-END DD&E RESOURCE AVAILABILITY COMPETITIVE COST OF ENERGY	PHASE CONTROL LAUNCH RATES ANTENNA POINTING & CONTROL ORBITAL ASSEMBLY	MICROWAVE EXPOSURE STANDARDS MW IMPACT ON OZONE LEVELS & UV RADIATION LAUNCH VEH IMPACT ON OZONE LAYER SPACE RADIATION LIMITS TO CREW
LEVEL 2— POTENTIAL SERIOUS IMPACT	LIGHTWEIGHT BLANKET, PRODUCTIBILITY DTV PERFORMANCE CHARACTERISTICS OPERATIONS/MAINTENANCE COST MW ELEMENT LIFE FAILURE RATES PWR CONVERSION DEVICES LIFE/DEGRADATION ATT CONT & STATIONKEEPING THRUSTER PERFORMANCE AND LIFE RECTENNA LAND REQUIREMENTS SYSTEMS COMPLEXITY PAYLOAD PACKAGING DENSITY REFLECTOR FILM DEVELOPMENT ON-BOARD ENERGY STORAGE	DC/RF CONVERTERS WAVEGUIDES SATELLITE POINTING & CONTROL SHUTDOWN/STARTUP OF MW ANTENNA LAUNCH VEHICLE SIZE SPACE MAINTENANCE PROCESSES ORBITAL TRANSFER OF LARGE SPACE STRUCTURES POWER DISTRIBUTION SWITCHING TECHNOLOGY/CAPACITY HIGH-TEMPERATURE HEAT EXCHANGERS PROPELLANT RESUPPLY IN ORBIT RELIABLE FLUID CONTAINMENT REFLECTOR FILMS FLATNESS CONTROL VOLTAGE & CURRENT REGULATION MICROWAVE BEAM DISPERSION ANALYSIS	PUBLIC ACCEPTANCE OF SPS RFI EMI HIGH-VOLTAGE SPACE CHARGING PLASMA INTERACTIONS LAUNCH VEHICLE NOISE & SONIC BOOMS GEO ORBIT AVAILABILITY SPACE COLLISIONS ENERGY BALANCES DTV EMISSIONS
LEVEL 3— POTENTIAL UNDESIRABLE IMPACT	ASSIGNMENT OF MW FREQUENCY LAUNCH VEHICLE RECOVERY/REFURBISHMENT ON-GROUND PWR FLUCTUATIONS & STORAGE REFLECTOR FILMS DEGRADATION RECTENNA ELEMENT LIFE/FAILURE RATES/ MAINTENANCE OIL USAGE (LAUNCH VEHICLES) LAUNCH SITE(S) LAND REQUIREMENTS INTERNATIONAL ENDARGERS/CRISIS BSE REQUIREMENTS SECURITY REUSABLE PARTS	CONSTRUCTION BASE LOGISTICS POWER CONDUCTION TERRESTRIAL LOGISTICS FUTURE NASA PROGRAMS RECTENNA OPERATIONS DEV PROGRAM SCHEDULE & FLEXIBILITY RECTENNA/UTILITY INTERFACES ENGINEERING AVAILABILITY RECTENNA INFORMATION MGMT SYSTEMS SATELLITE INFORMATION MGMT PROCESSING MANUFACTURING CAPABILITIES/DEMANDS	SAFETY & CONTROL OF LAUNCH VEHICLES ORBITAL CREW SAFETY POLLUTANTS FROM MINING & MANUFACTURING TERRESTRIAL WORKERS HEALTH & SAFETY MW EFFECT ON ECOLOGY, SOIL, WATER, AND ATMOSPHERE POLLUTANTS FROM TRANSPORTATION OPNS FAILED HARDWARE (ON SPS) DISPENSATION LAND USE NEAR RECTENNA

Table 1. Program Issues and Concerns

A Level 1 issue was defined as an issue which, if a negative result were determined or if there were a failure to resolve the issue, could result in the SPS program being labeled as unfeasible. If these issues were not resolved, or a work-around developed, they would be labeled as "show stoppers" and as a result the SPS program would more than likely be discontinued.

For example, if the capital needed to finance materials, equipment, labor, etc., could not be obtained, the SPS program would not get to the operational phase.

A Level 2 issue was defined as an issue which, if a negative result were determined or if there were a failure to resolve the issue, could result in serious impact to the SPS program. For example, if the solar cell cost was significantly higher than current projections, there might be serious impacts to the SPS program since a significant portion of the satellite cost is attributed to the cost of solar cells.

A Level 3 issue was defined as an issue which, if unresolved, would result in undesirable impact to the SPS program. For example, crew safety is considered a necessity but if the current plans for crew safety could not be achieved, then surely work-arounds could be developed to provide the safety requirements without significantly impacting the program.

The table presents the issues subdivided, based on the above Level considerations and into areas of economic viability, technical feasibility, and environmental acceptability. Specific information required for resolution of the issues was developed and a planned overall approach for resolution was identified. Summary results of these analyses are presented in Figure 1.

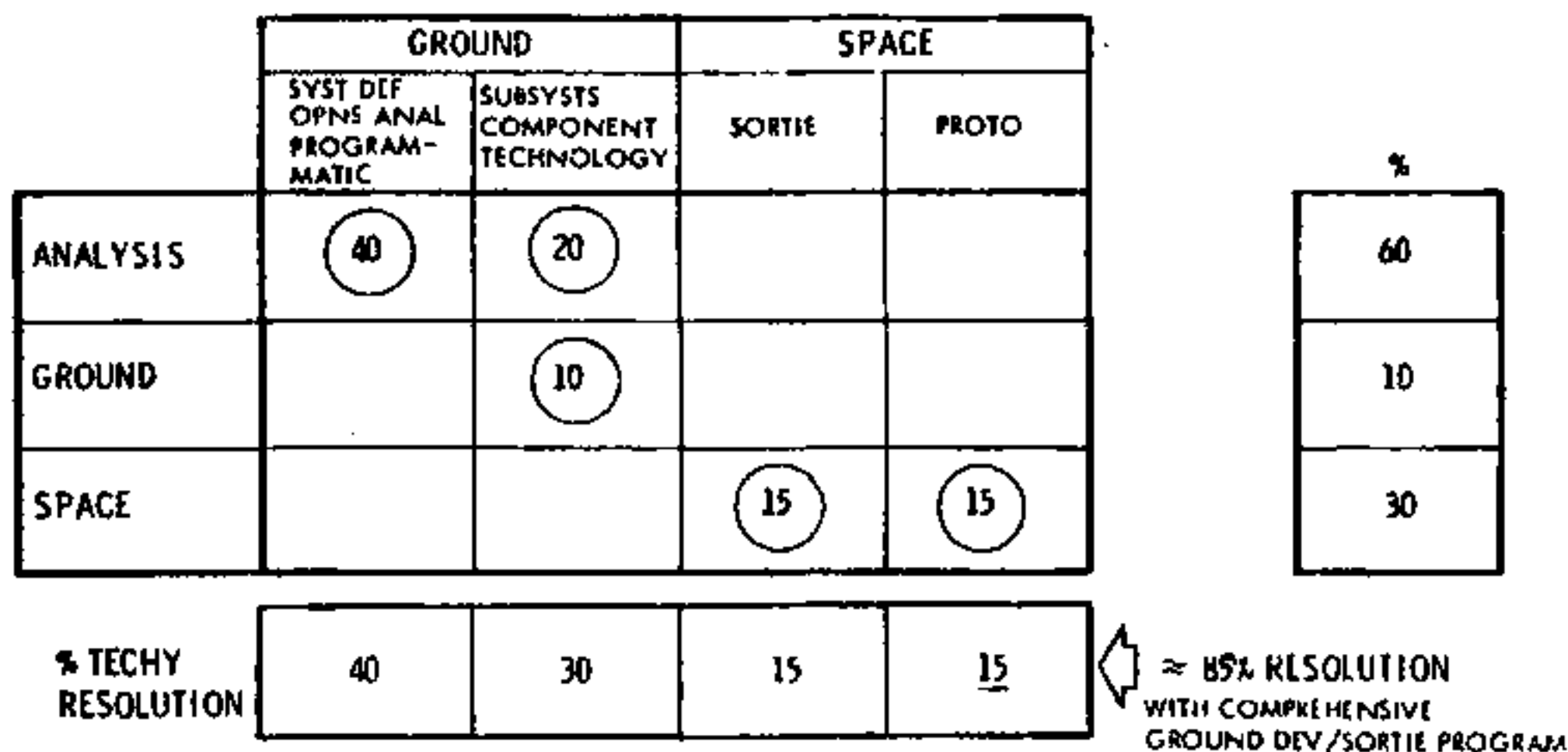

Figure 1. Resolution of Technical Issues

As shown, 60% of the technical issues can be resolved with analysis only; 10% require only ground testing for resolution; and the remaining 30% require space experiments or demonstrations for resolution. The figure also shows that 85% resolution of the issues may be accomplished prior to development of a prototype. Since this table was prepared, some of the issues have been resolved and plans have been developed leading to the resolution of others.

CRITICAL TECHNOLOGY AREAS OF AN SPS DEVELOPMENT AND THE APPLICABILITY
OF EUROPEAN TECHNOLOGY
D. Kassing and J. Ruth
Systems Engineering Department
European Space Agency, ESTEC, Noordwijk, The Netherlands

Introduction

Satellite Power System (SPS) evaluation studies conducted in Europe (Ref. 1,2) have shown that this proposed space energy system could be an additional energy source to other advanced energy systems, such as nuclear breeder and nuclear fusion reactors. The SPS could supply a significant portion of the base-load electricity required in Europe and hence could contribute to making Europe less independent on energy imports. Besides the potential benefits the studies have, however, also shown that high uncertainties exist with respect to technical feasibility, environmental acceptability, and economic practicality.

The purpose of this paper is to discuss a possible system development and implementation scenario for the hypothetical European part of a cooperative SPS effort and to characterise technology and systems requirements which could be used as an initial guideline for further evaluation studies. The technical analysis is based closely on current DOE/NASA SPS reference system (Ref. 3) and factors that could influence the utilisation of SPS's in W. Europe. It is understood that the scenario presented by the authors is not intended either as a prediction or as a recommendation, but as a tool for further evaluations.

The Scenario

A system of forty 5 GW units could supply some 20% of W. European electricity demand in 2030 (Fig. 1). After completion of a pilot plant demonstration around 2000 which has shown that the SPS is feasible, economic and safe, a stepwise implementation phase follows with at least 2 implementation lines, one for the U.S.A. and the other for W. European SPS's (Fig. 2). Together with the 60 SPS units assumed for the U.S.A. (Ref. 3), a minimum total of 100 units have to be constructed by 2030. This implementation allows a stepwise extension of the infrastructure needed for production, construction and transportation (Fig. 3).

To identify most critical technologies and systems, an SPS development plan was devised backwards from the initial operation date of the pilot plant to the present. It defines major milestones and the date when a new type of system element is required (Fig. 4). Table 1 gives assumed characteristics of appropriate space transportation vehicles and space bases. Figure 5 shows the resulting subsystem development scenarios. For the construction of the pilot plant in LEO a construction base has to be developed which would later (during system implementation) be used for the construction of the electric-propulsion COTV's.

Applicability of European Technology

The development scenario is divided into 3 phases; each phase following up specific objectives. Since early phases should improve the fundamental understanding of the concept and assist the definition of the SPS subsystems, it is understood that hardware required for early key experiments in space could be derived in most cases from state-of-the-art technology.

An evaluation process has therefore started at ESTEC (Ref.4) to identify those European technologies applicable to near-term studies and concept-technology verification investigations that will be needed if SPS's are to become a reality in the late 1990 s. Examples of advanced European space technologies are described including high power microwave amplifiers, antennas, advanced structures, multi-kilowatt solar arrays, attitude and orbit control systems, electric propulsion, the ARIANE launch vehicle and the near equatorial launch site in Kourou.

References

- 1) J. Ruth & W. Westphal, 1979, European Aspects of SPS, Final Report ESA CR (P) 1266
- 2) General Technology Systems Ltd., 1979, Study Field B- SPS-, Report GT 78008/B1 to 3.
- 3) DOE/NASA, SPS Reference System Report, October 1978, DOE/ER-0023
- 4) H. Stoewer, B. Tilgner, D. Kassing, European Technology applicable to SPS, Proceed. IAF 1979, Paper 79-174
- 5) Conservation Commission of the World Energy Conference 1978, Electricity Demand Projections, 1978

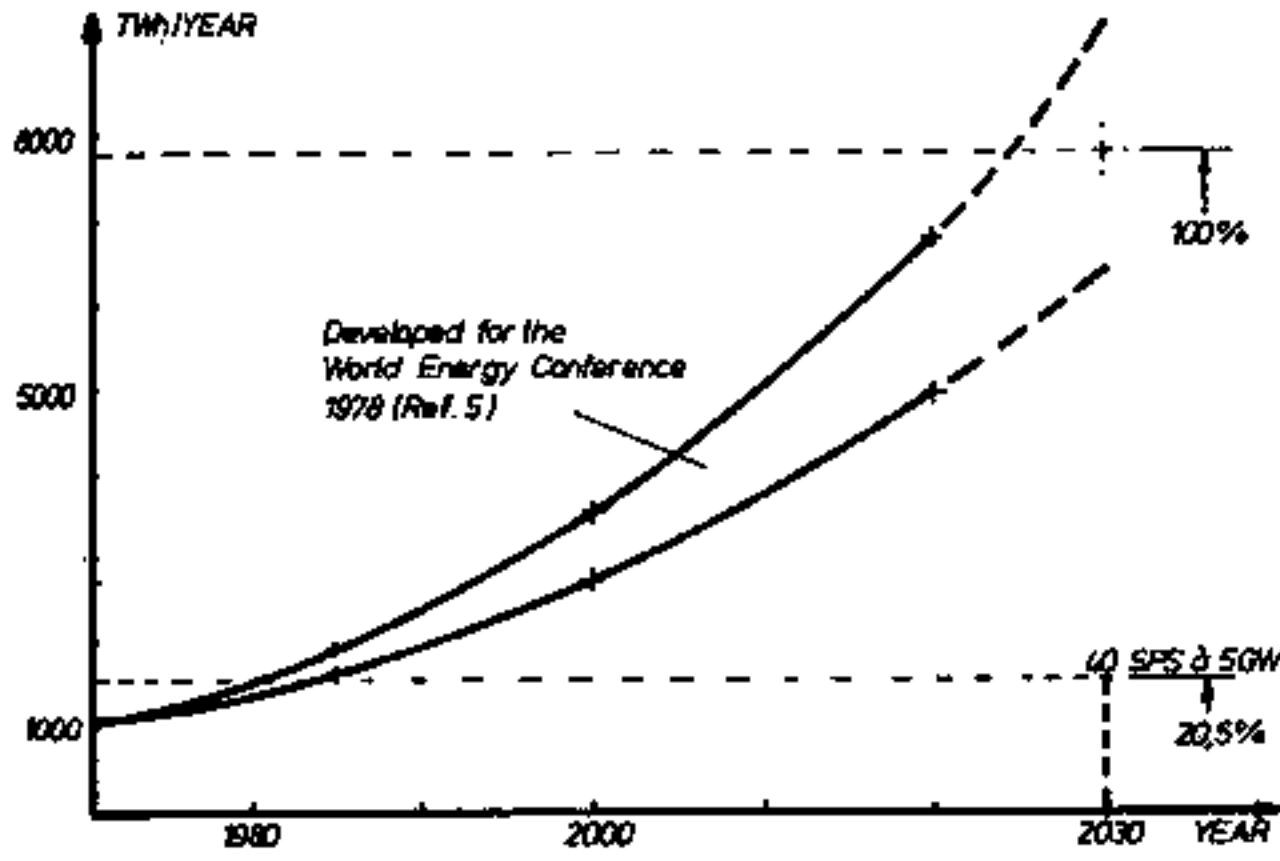

Fig.1: Electricity Demand Model for W Europe

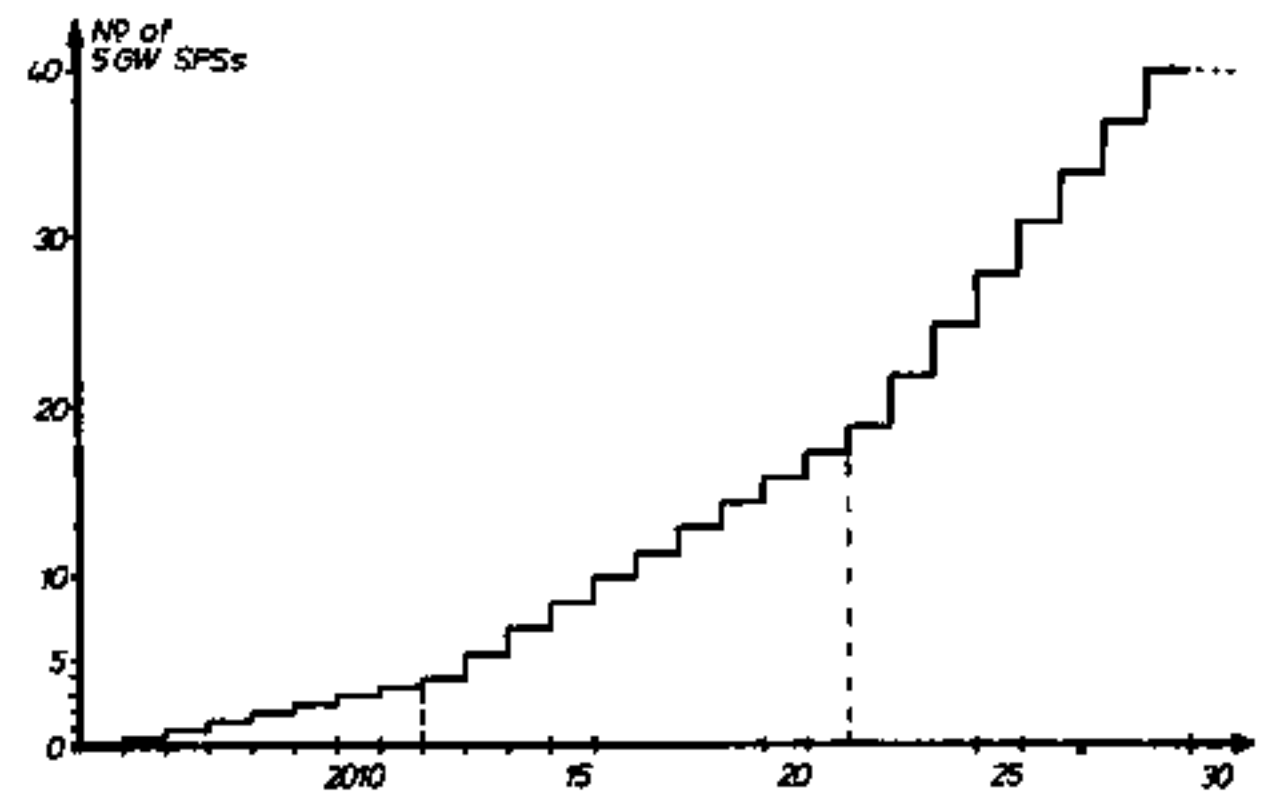

Fig.2: Implementation Scenario for 40 European SPSs

ELEMENTS ↓	PHASES →						
	Pre-implementation	1. Implementation Step: 1 SPS in 2 Years	2. Implementation Step: 1,5 SPSs per Year	3. Implementation Step: 3 SPSs per Year			
Operational HLLVs		3 units	2	3			
Operational PLVs				2			
Operational LSBs				2			
Operational COTVs		2	6	10			
Operational POTVs				2			
Operational GCBs				2			
Operational 5GW SPSs							
YEAR →	2000	05	10	15	20	25	30

Fig.3: Infrastructure needed for European Implementation Scenario

LAUNCH VEHICLES	ORBITAL TRANSFER VEHICLES	SPACE BASES
HLLV (150) - Heavy Lift Launch Vehicle*, IOD 1996 GEOW: 3870 t, Payload: 150 t	Exp. EPM - Electric Propuls. Module, IOD 1991 attached to GEO-Test Satellite, for orbit raising	LEO-Base-S/L deriv. Free-Flyer, IOD 1990 for constr. of GEO-Test Satellite and 2-MW-Dev. SPS, Crew 5-7
HLLV (450) - Heavy Lift Launch Vehicle*, IOD 2011 GEOW: 11020 t, Payload: 450 t	Small EPM - Electr. Propuls. Mod., IOD 1995 attached to 2-MW - Developm. SPS	Pilot LCB - Constr. Base for Pilot SPS, IOD 1997 in Low Earth Orbit (LEO) Si-opt.: Mass-500 t, Crew-30 Ga-opt.: Mass-350 t, Crew - 40
* Both vehicles 2-stage winged and fully reusable; Booster: CH ₄ /LOX; upper stages LH ₂ /LOX	Pilot EPM - Advanced Electr. Prop. Mod., IOD 1999 attached to Pilot Plant	Final LCB - Construct. Base for COTV, IOD 2000 in LEO Si-opt.: Mass-500 t, Crew - 30, Ga-opt.: Mass-350 t, Crew - 40.
Small PLV - Personnel Launch Vehicle Opt. 1 Space Sh. derivative, 5-12 pass. Opt. 2 HERMES-Type/ARIANE, 5-12 pass. IOD 1990 (after 1999: Emergency Veh.)	COTV - Electr. Propuls. Vehicle, IOD 2001 reusable; 180 days round-trip time; Payload: 3500 - 4000 t	LSB - Staging Base in LEO, IOD 2001 advanced LEO- Base, Mass-100 t, Crew - 10;
PLV (50) - Advanced Shuttle with 50-pass. module Flyback booster: CH ₄ /LOX; IOD 1999	Small POTV - Personnel Orbit Transfer Vehicle, reusable; LH ₂ /LOX, 2 stages, IOD 1992 5 - 7 pass.	GCB - Construct. Base for 5-GW-SPS Geostat. Orbit, IOD 2003 Si-Opt.: Mass- 4200 t, Crew - 240, Ga-Opt.: Mass- 3000 t, Crew - 340.
PLV (75) - Advanced PLV for 75-pass. module IOD 2011	POTV (80) - Large Pers. Orbit Transf. Vehicle IOD 2001, reusable, LH ₂ /LOX, 2 stages, 80 passengers.	
	POTV (160) - advanced version of POTV (80) for 160 passengers, IOD 2011	

IOD = Initial Operation Date

Tab.1: Characteristics of Space Vehicles and Bases

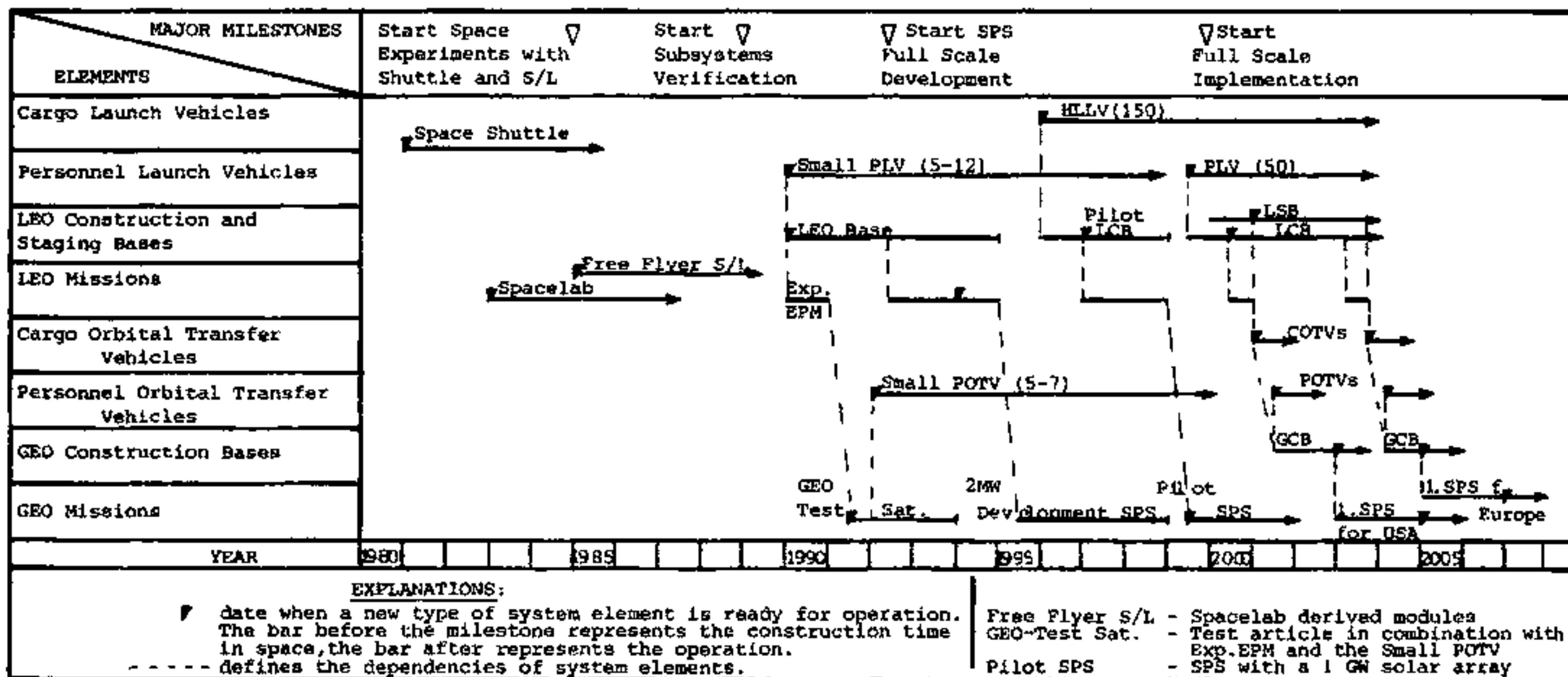

Fig.4: SPS Development Scenario

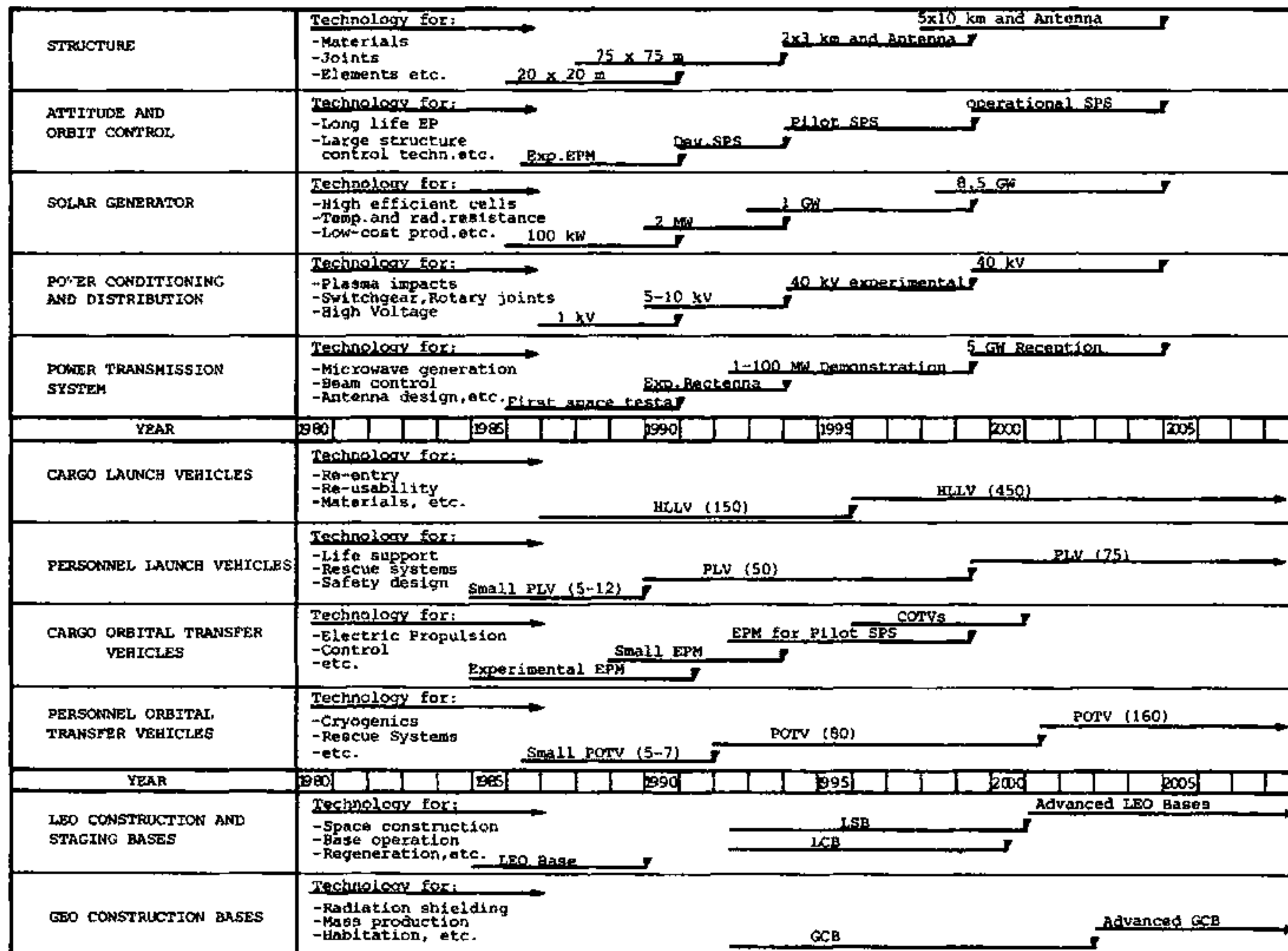

Fig.5: Subsystem Development Scenario

OVERVIEW OF ATMOSPHERIC EFFECTS

Donald M. Rote

Argonne National Laboratory

Effluents from the transportation system are the major cause of SPS-related atmospheric effects. These effects include inadvertent weather modification, air quality degradation, compositional changes in the stratosphere and mesosphere, formation of noctilucent clouds, plasma density changes, airglow enhancements, and changes in composition and dynamics of the plasmasphere and magnetosphere. In most cases, these effects have been difficult to assess because they involve processes that are either not well-understood by the scientific community or are speculative in nature, or because they involve extrapolations of known effects to unprecedented scales. Hence, with few exceptions, the results should be regarded as tentative.

HLLV launches have been found to have a significant potential for inadvertent weather modifications on a local scale. Under selected meteorological conditions such launches can affect convective patterns, alter cloud populations and induce trace precipitation. None of these effects are judged to be serious.

Air quality impacts of HLLV launches are predicted to be very small except possibly for nitrogen oxides. If a short-term air quality standard is set as anticipated, then ground-level concentrations of NO_2 due to rocket launches could exacerbate existing problems. However, the launches by themselves are not expected to exceed the expected standard. NO_2 production can also lead to slight increases in acidity of precipitation on a local, intermittent basis. It seems unlikely that the enhancement is great enough to cause significant environmental effects.

Stratospheric CO_2 and H_2O injections are estimated to be completely negligible from both the ozone depletion and greenhouse effect points of view. Small ozone reductions (a few %) are expected above 70 km, but the effect on the total ozone column would not be detectable.

Repeated injections of H_2O in the mesosphere will cause a long-term modification of the water concentration profile on the order of 15% near the launch latitude, with larger increases on a short-term, smaller scale basis associated with individual rocket launches. Short-term, small-scale ice clouds (noctilucent clouds) are expected to be formed but are not expected to reach global scales and therefore are not expected to cause climatic impacts.

Several mechanisms that are not completely independent of each other have been shown to produce both positive and negative large changes in D- and E-region plasma densities. It is presently not clear how large the net plasma density changes will be or even what sign they will take.

In the F-region, however, the picture is much clearer. We can predict with considerable confidence the scale of and with somewhat less confidence the duration of F-region holes caused by various engine burns of SPS space vehicles. Each POTV injection burn will result in an ionospheric hole on the scale of the continental U.S. HLLV circularization burns will produce holes one-tenth the size but twice per day. More speculatively, the periodic engine burns may lead to a chronic low-level depletion in a ring-shaped global region centered around the launch latitude. Crude estimates suggest a 10% plasma reduction in this region superimposed on periodic, small-scale, but much deeper, depletions. Confirmation with more detailed model calculations is required. Probably the major consequences of this depletion ring will be perturbations of VLF, HF, and possibly VHF wave propagation. Another impact of potential importance is the enhancement of airglow. The greatest enhancements observed to date are on the order of 10 kilo Rayleighs for certain emissions in the visible and near IR. Assessment of these effects is beyond Task Area 3's scope.

The effect of POTV and COTV emissions in the magnetosphere is perhaps least-well understood at the present time and least-well supported by observations. The masses and energies injected are large compared to naturally occurring values and therefore give cause for concern. Heating by the argon plasma beam is expected to lead to enhancement of dosage of trapped relativistic electrons. Production of artificial ionospheric electric currents similar to those associated with naturally occurring magnetic storms could be driven by the magnetosphere-argon ion beam interactions. Such currents could result in long telephone line and power line circuit-breaker tripping and enhanced pipeline corrosion. The presence of large quantities of neutrals (from POTV) and heavy ions can lead to substantial depletion of high energy charged particles and modification of auroral response to solar activity. The possibility also exists for the formation of plasma instabilities that could cause satellite communication signal interference. Finally, an appreciable amount of airglow may be generated especially near LEO by the impingement of the dense Ar^+ beam on the thermosphere. The significance of this airglow should be assessed by the remote sensing community.

The sun-weather effect that has been widely debated in the recent climate literature, if it is real, is likely to involve a coupling of the upper and lower atmospheres. Several mechanisms have been proposed to explain such a coupling. It has been conjectured that, if indeed modifications in the solar wind can influence climate through some such coupling scheme, then perhaps the SPS upper atmospheric effects we have been discussing could play a role in disturbing the coupling scheme. In that sense, upper atmospheric SPS effects may be casually connected to possible climate effects. However, until the sun-weather effect is placed on a firmer footing, and until the SPS upper atmospheric effects themselves are better understood, the potential effect of SPS

upper atmospheric effects themselves are better understood, the potential effect of SPS on climate and weather cannot be evaluated.

One final effect that has been investigated in the current assessment is the inadvertent weather modification likely to be caused by the rectenna's structure coupled with the release of waste heat. From the weather and climate points of view, the rectenna seems likely to have effects comparable with those due to other nonindustrial land-use changes covering the same surface area. That is, local, detectable meteorological effects that probably have little consequence.

IONOSPHERIC DISTURBANCE OVERVIEW
C. M. Rush
U. S. Department of Commerce/NTIA
Institute for Telecommunication Sciences; Boulder, Colorado 80303

The operation of the Satellite Power System (SPS) is currently designed to provide between 5 to 10 gigawatts of power on a continuing basis to the surface of the earth. At the center of the microwave power beam, the power density is of the same magnitude that could lead to enhanced heating of the ionosphere and to the creation of changes in the structure of the ionosphere. The degree to which the ionosphere and ionospheric-dependent telecommunication systems will be impacted by the operation of the SPS is, therefore, of concern.

A program of research and exploratory development that is national in scope has been undertaken in order to assess the potential impact of SPS operation upon the ionosphere. This program relies upon the utilization of ground-based ionospheric heating facilities in order to simulate the ionospheric heating that will proceed from SPS operation. Facilities located at Platteville, Colorado, and Arecibo, Puerto Rico, form the focus of experiments that have been undertaken in order to simulate observed results and to extrapolate the results to the SPS operational scenario.

Thus far the experimental program directed toward assessing telecommunication impacts due to SPS operation has received the most attention. In August, September, and October 1979, and again in March 1980, the Platteville high-powered, high frequency Facility was operated in a mode that simulates SPS ionospheric heating. Telecommunication systems operating in the VLF, LF, and MF portions of the electromagnetic spectrum were monitored. The performance of OMEGA (VLF), LORAN-C (LF), and AM broadcast (MF) stations was investigated during times when the Facility was "ON" and when it was not. The locations of the radio receivers that provided for the monitoring of the signal characteristics of the systems were chosen in order that the radio energy passed through the ionosphere modified by the Platteville Facility.

Figure 1 shows a typical example of the type of data and results that were observed. Shown on the figure is the phase and amplitude of OMEGA signals transmitted from Hawaii and monitored at Brush, Colorado, on August 16, 1979. The OMEGA-Hawaii signal is transmitted on a frequency of 11.8 kHz. The phase is given in microseconds (μ s) and the amplitude is decibels (dB). The hatched areas indicated above the time scale refer to those times that the Facility was operating in the "ON" mode. At all other times the Facility was not modifying the ionosphere.

Close inspection of the figure reveals little change in the behavior of the OMEGA phase and amplitude when the Platteville Facility was "ON" and when it was "OFF". Taking five minute averages of the phase and amplitude when the Facility was "ON" and when it was "OFF" shows that the phase was $3.82 \pm 1.54 \mu$ s with the Facility "ON" and $5.82 \pm 1.45 \mu$ s with it "OFF"; the amplitude was 14.9 ± 1.30 dB

with the Facility "ON" and 15.1 ± 0.90 dB with the Facility "OFF". Data taken on different days and data observed on the LORAN-C and AM broadcast stations show no change in the performance of VLF, LF, and MF systems that can be associated with operation of the Satellite Power System.

The experimental program geared toward assessing the physical phenomenon involved in ionospheric/microwave beam interactions relies heavily upon the Arecibo Facility. It is anticipated that this Facility will be supplying SPS comparable power density to the ionosphere in the near future. Theoretical studies have been directed toward developing predictive models of the ionosphere that include the effects of enhanced electron heating in the D region and thermal self-focusing in the F region.

The SPS Ionospheric Disturbance program involves the expertise of a number of individuals and organizations. The organizations actively participating in the assessment are listed in Table 1. The program is directed toward assessing the degree to which the operation of the SPS will modify the ionosphere and impact upon the performance of telecommunication systems.

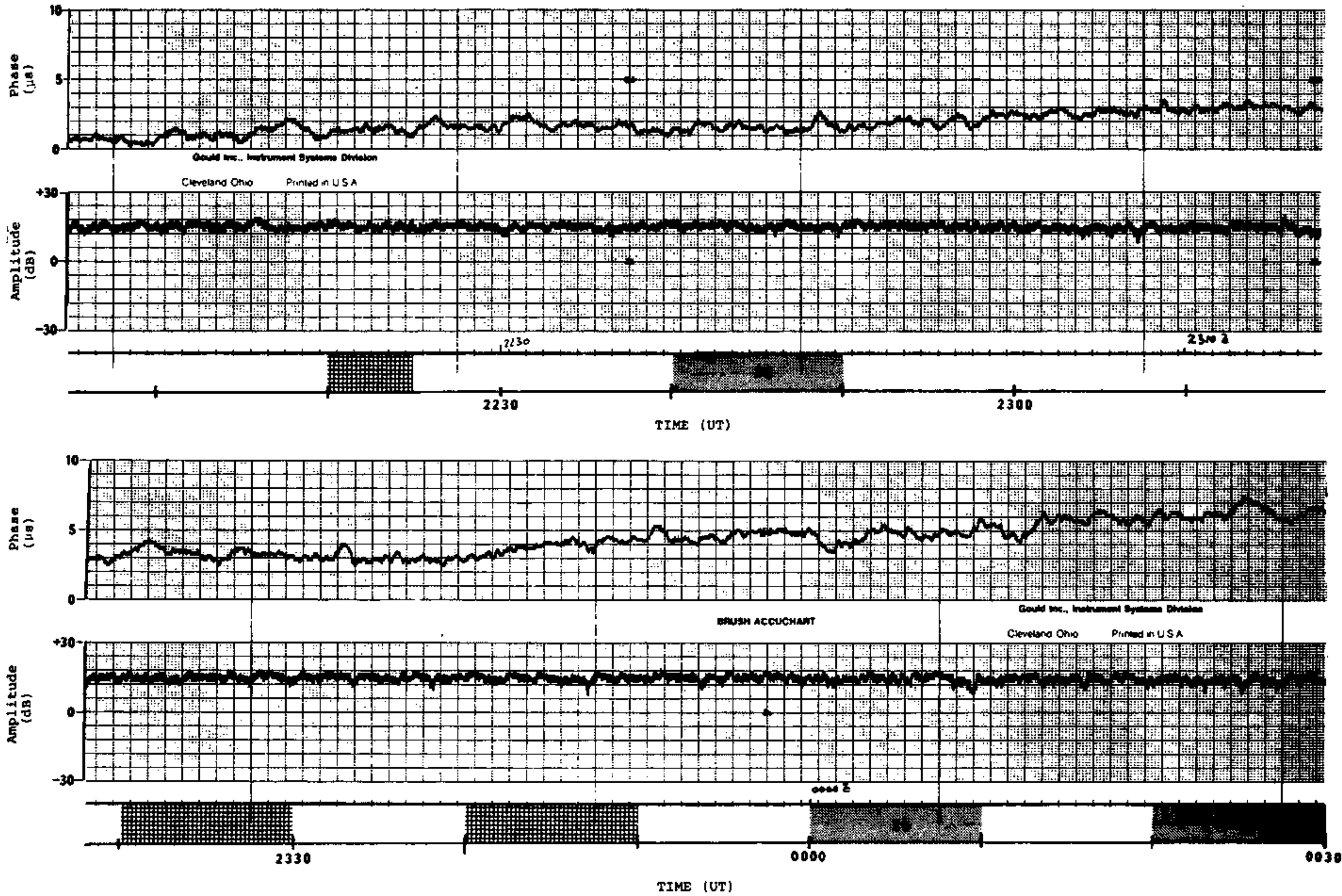

Figure 1. OMEGA phase and amplitude recorded at Brush, CO, from Hawaii at 11.8 kHz on August 16, 1979.

Table 1. Participating Organizations in the SPS Assessment of Ionospheric Disturbance Effects

<u>Organization</u>	<u>Program Area</u>
Institute for Telecommunication Sciences } SRI, International Emmanuel College	Telecommunications Effects
Los Alamos Scientific Laboratories } Rice University Case Western Reserve University	Experimental Physics Studies
United Technologies Research Center } Plasma Physics Laboratory, Princeton University of Colorado National Center for Atmospheric Research	Theoretical Studies
Raytheon Corporation } University of Illinois	Expert Advisors
Institute for Telecommunication Sciences }	Overall Program Management

ELECTROMAGNETIC COMPATIBILITY OVERVIEW

K. C. Davis

Pacific Northwest Laboratory, P.O. Box 999, Richland, WA 99352

In the process of delivering 5 Gw of electrical power the SPS will, due to limitations of available technology, contribute undesired electromagnetic radiation over a broad spatial and spectral range. Because of the large power handled by SPS and the extreme sensitivity of some other electromagnetic systems, even a very small fractional loss from the SPS can have a major impact.

Assessment of the Electromagnetic Compatibility (EMC) impact of SPS has two major parts; determination of the emissions expected from SPS including their spatial and spectral distributions, and evaluation of the impact of such emissions on electromagnetic systems including consideration of means for mitigating effects. Determination of SPS emissions is hampered by uncertainties in the design of the system and the unavailability of representative components for testing. Some aspects, such as the spatial distribution of microwave power at the intended transmitting frequency, can be computed with high assurance of accuracy. Other important values, such as power spectral densities for noise sidebands and harmonics, must be estimated or extrapolated from existing systems.

Evaluation of impacts is aided by the existence of well-developed techniques and a substantial body of data relevant to SPS EMC. The problem remains very large because of the number of potentially impacted systems. It has been necessary to select representative and/or important systems based on sensitivity to expected EMC emissions, proximity to proposed rectenna sites, or severity of consequences if affected. Specific testing of systems and equipment under conditions representing SPS exposure has been done to fill gaps in previous data and more is planned.

SPS EMC impacts fall into four major categories:

(1) Effects of High Microwave Power Densities on Electronic Systems:

These effects are expected only relatively near rectenna sites (within approximately 50 km) but in that area could affect a wide variety of systems including computers, controls, sensors and communications. Well-developed techniques exist to mitigate the expected effects and their effectiveness has been demonstrated in SPS-related tests. The major impact in this area may be the cost of modifications. Spacecraft transiting the microwave power beam are special cases but no insurmountable problems have been identified.

(2) Effects of High Power Levels at 2.45 GHz on Receiving Systems Operating at Other Frequencies:

These will be most severe near rectennas but could affect sensitive systems at large ranges if they are strongly coupled to SPS, e.g., by large upward-looking antennas. Most of the effects can be mitigated, for example by antenna modifications or addition of RF filters. Degradation may result in some cases and modification may be unacceptable for some systems. Rectennas will have to be sited to avoid sensitive facilities, e.g., Radio Astronomy and Deep Space Research by large ranges (100 km or more).

(3) Effects of SPS Emissions at Other Frequencies on Receiving Systems Operating At or Near Those Frequencies:

These emissions may cause problems throughout the hemisphere below SPS spacecraft since they would not be expected to have the same spatial distribution as the main power beam. Rectennas may also be a significant source of emissions at spurious frequencies. SPS spurious emissions are

subject to stringent constraints in FCC and International Regulations, but there remains some concern that very sensitive receiving systems operating near 2.45 GHz or harmonics may experience interference.

(4) Effects of Scattered Sunlight from SPS Spacecraft:

Each spacecraft will, even if it scatters only 4% of the sunlight it intercepts, be brighter than any other object in the night sky except the moon (as bright as the planet Venus at its brightest). Sixty SPS spacecraft will have the effect of a fractionally illuminated moon always present in the night sky. This would cause substantial interference with ground-based astronomy and other scientific observations of the night sky requiring dark conditions. Mitigation would require substantially darker SPS spacecraft or relocation of a number of observational facilities to space.

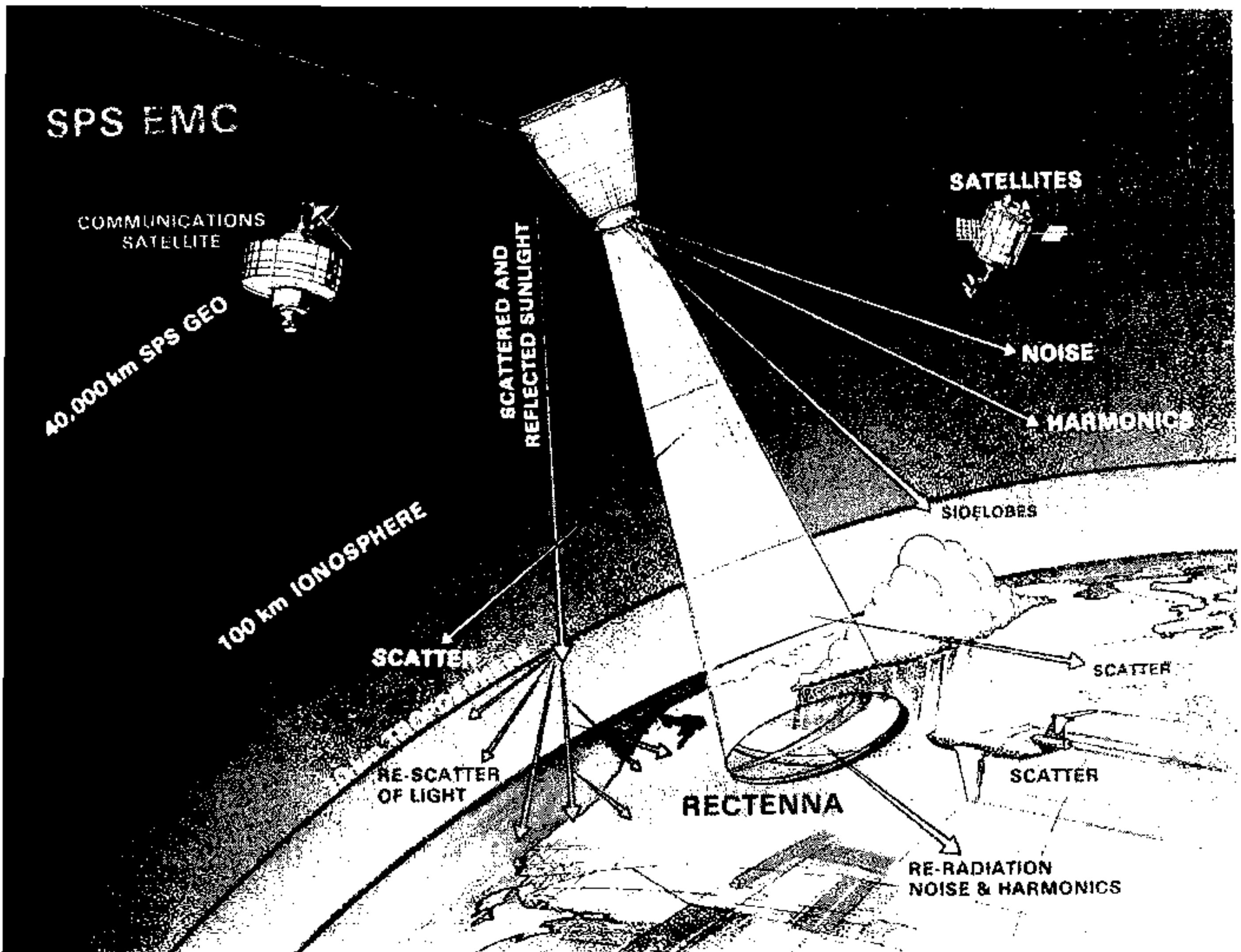

NONMICROWAVE HEALTH AND ECOLOGICAL EFFECTS: OVERVIEW
Margaret R. White, Lawrence Berkeley Laboratory,
University of California, Berkeley, California 84720

This study is one of five being carried out, under the auspices of the Department of Energy, to assess the environmental impacts of the Satellite Power System (SPS). The assessment is using as a baseline the 1978 SPS Reference System developed by NASA and its contractors. The potential impacts are based on current knowledge with regard to the consequences of constructing and operating SPS as defined by the reference system. Studies of the nonmicrowave health and ecological effects encompass impacts on the public, the terrestrial worker, the space worker, and the ecology and agriculture.

For the public there are possibilities of increases in pollution (water, air, solid waste); noise near launch, landing and construction sites; transportation accidents (from both terrestrial transport of materials and space transport accidents); toxic materials exposure (from mining, manufacturing, and fuel use); eye injury from reflected light; skin cancer from reductions in ozone; acid rain; unusual weather changes; electromagnetic field exposure; and long-term, low-level effects from laser-beam scattering (lasers are being tentatively considered as an alternate to microwaves for transmitting solar energy to earth). The majority of the impacts for the public are expected to be increases in conventional hazards, and can probably be avoided by using methods and regulations now used by industry for mitigating unwanted effects. A few, e.g., launch and landing noise, and accidents or unique toxic materials, will need special planning and possibly research to avoid unduly endangering the public.

The terrestrial worker will be exposed to air and water pollution; all the conventional occupational hazards associated with mining, manufacturing, transport and construction; possibly exotic toxic materials; the noise and accident hazards at launch and landing of space vehicles; and the electromagnetic fields and high voltages at rectennas (earth-receiving stations). Again, most of the hazards to health are of a conventional type and probably can be mitigated with use of usual procedures and safety regulations. Such things as launch and landing noise and accident and exposure to unusual toxic materials will take special study and precautions to lessen hazards.

The space worker will be exposed to some conventional hazards, as well as the unconventional hazards of living and working in space. These will include space travel; effects of weightlessness; space ionizing radiation; occupational hazards of construction under weightless conditions; emergency medical and dental problems; extravehicular activity; psychological problems of extended confinement; life support failure; spacecraft charging (with possibilities of electric shock); electromagnetic field exposures; high voltage; and the possibility of meteoroid or space debris collisions. It is expected that current studies, research, improvements in design, etc., will assist in minimizing most of these hazards between now and the time when SPS goes into production and operation.

Ecology and agriculture will also be subjected to the conventional hazards of air, water, and solid waste pollution resulting from mining, manufacturing, transportation, and construction. At launch and landing and rectenna sites habitats or agricultural land will be lost and/or damaged. Wildlife and possibly agricultural animals will be disturbed by launch, landing, and construction noises, and may be disturbed by reflected light from the

space structures. There is a slight chance that ecosystems and agriculture may be damaged by ozone depletion (ultraviolet light) and by electromagnetic fields in the vicinity of rectenna and power transmission lines.

This assessment has been based on the 1978 reference system which was, of necessity, extremely preliminary in nature. Thus, much specific information needed to assess impacts in a quantitative manner was unavailable. The assessment was also constrained to use current knowledge, i.e., no research was involved. Therefore, there are still many uncertainties which must be resolved before impacts can be specified in detail.

Many of the people working in fields related to the potential impacts described in this assessment predict that ways will be found to mitigate or eliminate many of these impacts before SPS is put into operation. In order to minimize impacts, in-depth studies, research and design changes will be necessary.

SPS MICROWAVE HEALTH AND ECOLOGICAL EFFECTS - PROGRAM AREA OVERVIEW
Daniel F. Cahill

Exp. Biol. Div., U.S. Env. Protection Agency, Res. Triangle Park, NC 27711

The Reference System for SPS proposes to employ microwaves as the means by which power will be transmitted from the satellite to ground-based rectenna sites. An operating frequency of 2450 MHz CW is considered optimum at this time because this frequency has relatively low atmospheric transmission losses, is not allocated as a broadcast frequency in the U.S., and the technology exists to mass produce power amplifiers for this frequency.

The necessity for considering the potential microwave health and ecological effects of the SPS is based on the anticipated power levels which the SPS will radiate. It is expected that the maximum ground level power density would be 23 mW/cm² at the center of a 10 by 13 kilometer rectenna and 1 mW/cm² at its edge. Beyond the controlled area of the rectenna site the power densities would range from tens of μ W/cm² to nW/cm².

The resultant exposure scenarios are: occupational exposures of adult male and female workers to 0.1-23 mW/cm² on an intermittent basis; brief, transient exposures of members of the general public and airborne biota to levels of 0.1-23 mW/cm²; continuous exposure of the general population, comprised of all age groups and various states of health, to .0001-0.1 mW/cm²; continuous exposure of on-site ecosystems to 0.1-23 mW/cm² and off-site ecosystems to .0001-0.1 mW/cm².

Public acceptance of the SPS is crucial to the viability of the concept. This can only be gained if a number of important issues are addressed and satisfactorily answered. Not the least of these are the potential microwave health and ecological effects (MW/H/E). Because of the short timeframe allotted to the Concept Development Phase of the SPS program, the MW/H/E area was necessarily focused on two near-term objectives, the need to investigate those apparently credible reports of biological effects occurring at 2450 MHz which had not yet been corroborated and an examination of specific questions resulting from the operation of an SPS system. As a result, SPS-sponsored research was directed at establishing dose-response relationships and threshold levels for the effects of relatively short term exposures at moderate to low power densities (1-23 mW/cm²) on birds and bees and on the hematological/immunological, teratological and behavioral responses of mammals. The current status of this research will be presented.

The Ground Based Exploratory Research Phase of the SPS program will provide the time for an evolution of the MW/H/E program. The general direction of the research program during this period will be discussed.

A considerable amount of health effects research is conducted at a frequency of 2450 MHz outside of the SPS program. Some recent research results which may have implications for the SPS program will be briefly reviewed. These include the reports of: Thomas et al. on microwave/drug interaction; Stern et al. on behavioral thermoregulatory response to microwaves; Adair and Adams on autonomic thermoregulation; Lovely et al. on behavioral and biochemical effects of low level exposures and the Johns Hopkins report on the health status of employees at the U.S. Embassy in Moscow.

AN EVALUATION OF THE LAND AND MATERIAL REQUIREMENTS
FOR THE SATELLITE POWER SYSTEM

Samuel D. Ankerbrandt
PRC Energy Analysis Company

Current research and evaluation of the physical resources requirements for SPS concentrated on three topics: land requirements and the siting of rectenna; the environmental impacts of a rectenna siting, and the materials requirements for SPS. The first two of these topics focus exclusively on the earth-based element of the SPS while the materials assessment considered requirements for both the space and earth systems. The identification, classification, and selection of adequate areas deemed eligible for rectenna siting is critical to further consideration of the SPS reference system. Although each specific rectenna site will generate unique environmental, social, and economic impacts, the prototype environmental assessment illustrates the range of problems which may be encountered. The sheer size and scope of total SPS operations begs questions relating to detailed materials requirements and the availability which are addressed in the materials assessment work.

The methodology employed in the rectenna siting work has been one of systematically eliminating areas in the contiguous forty-eight states which could not be used for rectenna siting. Areas were eliminated through the analysis of categories of variables (Exhibit I) ranging from those variables which would absolutely exclude rectenna siting, to those which potentially might exclude rectenna siting, to those affected by SPS design and/or cost constraints. Among the absolute exclusion variables are topography, specifically designated lands such as national recreation areas and military reservations, specific land use areas such as populated areas and interstate highways, and areas which pose problems of electromagnetic compatibility. Potential exclusion areas include specifically designated lands such as Indian reservations and national parks and grasslands, specific land-use areas such as croplands, areas which pose problems of electromagnetic compatibility, and flyways of waterfowl and other birds. Design/cost variables included natural occurrences such as tornadoes, freezing rain, and seismic risk.

These "eligible" areas are plotted on 7.5 minute quad maps roughly 13 kilometers on a side for maximum definition and the analytic results have been automated to enhance further studies as well as the performance of sensitivity analyses. Sensitivity analyses and validation studies have been performed as part of the work. In short, the methodology for determining "eligible" areas for SPS rectenna sites is highly automated, elegant, and widely applicable. What the methodology shows is that there probably are adequate suitably-located areas for rectenna sites in the U. S. It shows that topography is the most important physical variable in determining eligible areas; sites can be placed in different terrain but only at substantial cost penalties incurred in site preparation. Important questions the methodology does not completely address are those concerning electromagnetic compatibility and the effect of microwave energy on migratory birds.

Considerations for the selection of a specific rectenna site has been addressed in a prototype environmental impact statement (EIS) performed for a site in the California desert about 250 kilometers north of Los Angeles. This SPS study benefitted from data assembled and analyses performed for an EIS for a geothermal project in the same area and required only the hypothetical placement of a rectenna in the area and alteration in the analyses. The specific objectives of

the study were: (1) to develop a comprehensive prototype assessment of the non-microwave-related impacts on the natural and human environments of the SPS reference systems ground receiving station (GRS); (2) to assess the impacts of GRS construction and operations in the context of actual baseline data for the specific site; and (3) identify the critical GRS characteristics or parameters that are most significant in terms of both the natural and human environment. The prototype EIS concluded that the critical project parameters include: the sheer size and intensity of use of the contiguous land area required by an SPS GRS; the lack of flexibility in siting individual rectenna structures once the rectenna boundaries are established; the difficulties in finding suitable sites that do not conflict with other societal needs and values; uncertainties relating to reestablishing nature ecosystems following total ecosystem modifications during construction, and the related need for further research into microclimatic effects near the ground-surface beneath the rectenna panels; the proposed two-year GRS construction schedule which has significant implications for project socioeconomic impacts, air quality, water supply and biological resources and possible logistical problems for GRS construction - all of which could be reduced by extending the construction schedule; and the public versus private GRS ownership which has significant implications for GRS impacts on the local tax base.

Since the earth and space components of the SPS will require enormous amounts of materials, a materials assessment was conducted to detail the material requirements for SPS and to identify potential availability problems and constraints so that responsive action could be defined and incorporated into overall SPS planning. The materials assessment analysis identified 22 materials used in the SPS, and tracing the production processes for these 22 materials, identified a total demand for over 20 different bulk materials and revealed a requirement for nearly 50 raw materials. The analysis evaluates each material in terms of world and domestic supply, manufacturing capacity and adequacy of the data base. The refined methodology uses computerized screening of the materials with the flags raised at various threshold levels as a function of several parameters, such as current domestic and world production rates and domestic and world reserves. Thresholds can be changed and the analysis rapidly run to determine sensitivities.

Assessment of these SPS material requirements produced a number of potential material supply problems (Exhibit 2), the more serious associated with the solar cell materials (gallium, gallium arsenide, sapphire, and solar grade silicon), and the graphite fiber required for the satellite structure and space construction facilities. In general, the gallium arsenide SPS option exhibits more serious problems than the silicon option, possibly because gallium arsenide technology is not as well developed as that for silicon.

EXHIBIT 1. CATEGORIES OF THE VARIABLES

ABSOLUTE EXCLUSION

Inland Water
Military Reservations
Atomic Energy Commission Lands
National Recreation Areas
SMSA's
Adjusted Population Density
Marshland Vegetation
Perennially Flooded Areas
Endangered Species
Interstate Highways
Topography Unacceptable
EMC-A150
EMC-A100
EMC-A50

POTENTIAL EXCLUSION - HIGH IMPACT PROBABILITY

Indian Reservations
National Forests and Grasslands
Wild and Scenic Rivers
Agricultural Lands - Mostly Cropland
Agricultural Lands - Irrigated
EMC-P150
EMC-P100
EMC-P60
EMC-P50

POTENTIAL EXCLUSIONS - IMPACT UNKNOWN

Flyways of Migratory Waterfowl - Ducks
Flyways of Migratory Waterfowl - Geese

DESIGN/COST VARIABLES

Tornado Occurrence
Acid Rainfall
Snowfall
Freezing Rain
Sheet Rainfall
Wind
Lightning Density
Hail
Seismic Risk
Timbered Areas
Water Availability

SOCIETAL ASSESSMENT

MATERIALS

MATERIAL	PERCENT SUPPLIED AS BY-PRODUCT	WORLD PRODUCTION GROWTH RATE	SPS PERCENT OF DEMAND	NET PERCENT IMPORTED	PERCENT WORLD RESOURCE CONSUMPTION	COST \$/kW
Threshold Value	50%	10%	10%	50%	200%	\$50/kW
Gallium	A	A	A	A		
Graphite Fiber		A	A			A
Sapphire		A	A			A
Silicon SEG		A	A			A
Gallium Arsenide		A	A			A
Electricity						A

SOCIETAL ASSESSMENT - INSTITUTIONAL ISSUES
S. I. Shotland
PRC Energy Analysis Company

The objectives of institutional issues studies during the CDEP were to (1) define key institutional areas, (2) establish an information base, and (3) determine whether institutional mechanisms might significantly affect SPS development. Four basic areas were addressed. These included: Finance and Management scenarios; Regulatory issues have been addressed in two study phases, as shown in Figure 1. Preliminary assessment studies were completed in 1978. Subsequently, SPS institutional studies were defined further, and have been addressed in ongoing studies.

Two studies assessed the feasibility and advantage of alternative SPS finance and management scenarios. The studies recommended public sector financing at least for the R&D phase. In addition, an international management organization was recommended for the SPS, a la the COMSAT/INTELSAT model. Private participation in SPS would be a function of the busbar cost of electricity, since this determines cash flow and rate of return on investment. The preferred interim and ultimate management framework needs further definition.

Regulatory issues were addressed in three studies. These included studies on state and local regulation of energy generation facilities, and the trend of federal agency involvement in the SPS. The present framework for state and local regulations of power plant construction and operation has limited applicability to the Satellite Power System. Regulations are in a state of flux, and maybe inadequate to deal with the SPS.

The study on federal regulation of microwave standards reported that the regulatory process and the voluntary $10\text{mW}/\text{cm}^2$ standard is undergoing review. Due to different philosophical approaches to microwave standard setting in the West and East European nations, there is no worldwide consensus on standards. U. S. and Western standards are based on the principal of risk/benefit, with standards set on order of magnitude below the threshold of known harmful effects. Soviet standards permit no perceptible effects. However, there is a trend toward convergence of standards; with a lowering of U. S. and Western standards to more stringent levels and a relaxation of Eastern European standards. Still to be determined, however, are definitions of what constitutes "hazard" or "adequate" safety margin in terms of microwave exposure. The study concluded that without definitive scientific data on microwave bioeffects, SPS use of a microwave power transmission link would engender increased public concern. In addition to these studies, an effort was made to identify federal entities with possible roles to play in SPS development. Forty-four major agencies were identified that could be expected to participate in various phases of SPS program development.

In the area of SPS utility integration, six studies have focused on specific technical and institutional integration issues. Two studies have assessed the regulatory, institutional and technical utility planning and operations constraints associated with siting 60 rectennas to serve power demand load centers in the continental U. S. One siting constraint scenario is shown in Figure 2. The studies concluded that SPS could be integrated with the utility system using state-of-the-art transmission and load management technology. However, some transmission distance problems could be encountered in the West. In addition, institutional barriers to utility ownership of SPS rectennas or bulk power purchase would exist, at least until the SPS is fully operational.

The issue of SPS insurance was addressed in a study performed by an aerospace insurance broker. The objective was to identify perceived SPS insurance risks, and how the insurance industry would respond. SPS poses many exposures to risk, due to potential financial losses from extensive launch and space construction activities, and from liability to third parties. Insurance underwriters have shown a willingness to insure aerospace risks as the industry develops. The study therefore concluded that insurance could be provided to minimize exposure to certain SPS risks during pre-operational and operational phases. Such insurance could result from continuing liaison with the insurance underwriting industry, through compilation of risk and actuarial data on the SPS and aerospace insurance premiums.

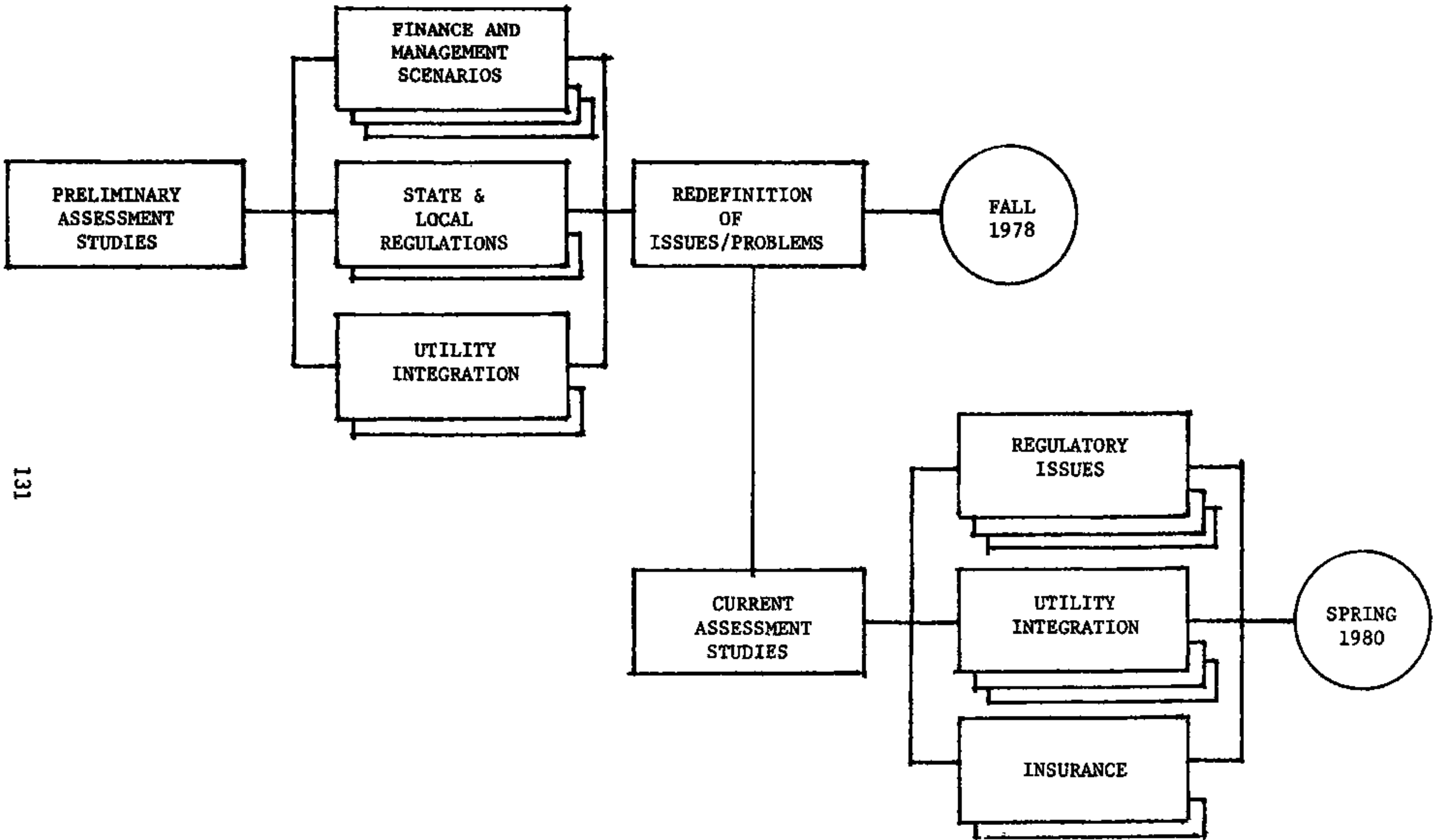
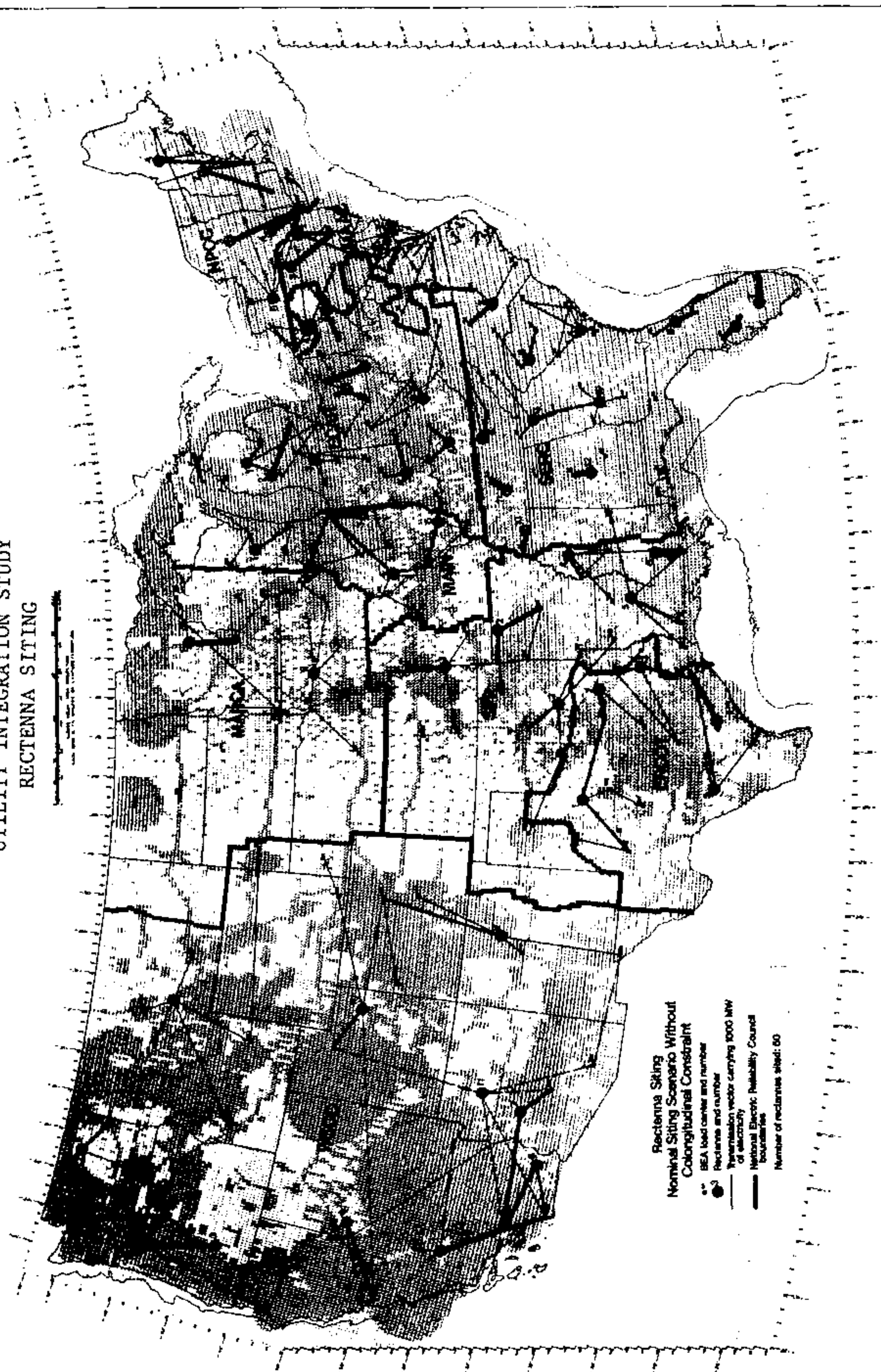

FIGURE 1
SPS INSTITUTIONAL ISSUES ASSESSMENT PROCESS

FIGURE 2
 UTILITY INTEGRATION STUDY
 RECTENNA SITING



Rectenna Siting
 Nominal Siting Scenario Without
 Colongitudinal Constraint

- * BEA load center and number
- Rectenna and number
- Transmission vector carrying 1000 MW
- National Electric Reliability Council boundaries
- Number of retransmitters sited: 60

SOCIETAL ASSESSMENT - INTERNATIONAL ISSUES

A. Daurio

Planning Research Corporation

Studies were undertaken in essentially two phases. Preliminary assessment studies dealt with international agreements (primarily associated with availability of geostationary orbit positions, allocation of the radiofrequency spectrum and microwave exposure standards) and military implications of the SPS. Other papers concerned with prospective organizational structures and finance and management contributed to a preliminary understanding of international issues.

A major preliminary conclusion was that the scope and quality of international tort laws and existing space treaties present no unusual legal prohibitions to SPS development. International acceptance would be strongly influenced by both the real and perceived military character and capabilities of the SPS. An international organization - a la INTELSAT - was strongly indicated for SPS.

Two studies are being done currently: 1) a further study of military implications, whose primary purpose is to demonstrate how a non-military SPS can be achieved; 2) a study to develop a strategy for international participation in the SPS program.

Threats posed by each of the major components of the SPS were considered to be of four types: 1) force delivery, 2) C³I, 3) military support and 4) institutional. It was found that the present reference system capabilities are primarily of a military support nature. Most other military threats would require deliberate modification of the current reference system design.

The SPS is vulnerable to: 1) either conventional attack or nuclear weapons, 2) electronic or chemical/biological warfare, 3) terrorism/sabotage, 4) mutiny/strikes, or 5) collisions with other space objects. However, overall, it remains to be seen whether SPS is any more vulnerable than other ground-based energy systems to such threats. It appears to be no more vulnerable than other systems in the economic infrastructure (water reservoirs, pipelines, roads, etc.)

Safeguards which can reduce threats and vulnerabilities to a tolerable level are of a technological or institutional nature. Technical means include long range space surveillance or adoption of counterforce tactics. Two important institutional safeguards would be: 1) resident inspection in orbit and 2) agreement governing proximity of objects to satellites and the right of self defense.

Development of an international participation strategy is important even for the situation in which an SPS program is purely American. Some form of international involvement is inevitable for these reasons: 1) the SPS uses international resources such as the geostationary orbit and the radiofrequency spectrum; 2) consequently, the SPS is subject to existing international treaties and conventions governing use of these resources and responsible international agencies (e.g., ITU and UN); 3) SPS operations have a global impact which other nations would not be able to ignore. In addition, the SPS is an energy technology with a potential for global development and use. On this basis, it is desirable to involve other nations.

Findings of this current study have been based on: 1) foreign assessments of the SPS appearing in the literature and ascertained through existing contacts

(e.g., ESA and IAF); 2) experience of other international organizations and agencies (e.g., COMSAT, INTELSAT, INMARSAT and IEA); 3) consideration of the world legal and political climate with respect to SPS-related issues. It has been found that while the global need for SPS is not yet well-defined, the primary determinant for European utilization is availability of rectenna sites. Organizationally, governmental management of a domestic effort is preferable. Based on the experience of other organizations, a U.S. attempt to dominate an international enterprise would meet with resistance. A cooperative program could be initiated through the IEA. Means should eventually be established for participation by developing countries.

There are several options for promoting greater international participation in an SPS program. This will most likely be an evolutionary process, in view of the time it has taken to negotiate previous international space treaties and establish other international technology development enterprises. However, any international strategy for the SPS would share certain basic goals. These include: 1) building upon existing international contacts, 2) utilizing existing international agencies and agreements, 3) taking cognizance of international concerns and regional needs, 4) encouraging broad foreign participation, 5) promoting international understanding.

The conclusions for this issue area are closely related. Foreign participation in SPS development depends upon U. S. willingness to allow international involvement and continuation of an R&D program. The U. S. should not seek substantial control of any international development program as this will adversely affect a number of long-term U. S. interests. Since military uses of an ostensibly civilian SPS cannot be completely eliminated, early clarification of U. S. intentions is desirable. Both threats and vulnerabilities can probably be reduced to acceptable levels by enlisting international participation, especially through creation of an international resident inspection team and other negotiated agreements.

PUBLIC CONCERNS
S. R. McNeal
PRC Energy Analysis Company

This paper focuses on the role of the public in the SPS Concept Development and Evaluation Program (CDEP).

The role of the public is important for two reasons: 1) public acceptance is an essential part of its ultimate realization; 2) public acceptance is no longer possible unless the public is involved, to the extent that its concerns are made known and satisfactorily resolved in the development process.

Public acceptance was studied by A. Bachrach, Environmental Resources Group and S. Klineberg and C. Gordon, Rice University. The results of these studies suggest that public acceptance of SPS will not be easily obtained, yet it will be essential to its development. There are several issues about SPS which are likely to be important in public acceptance, some of which are the effects of microwaves, centralization/decentralization and military implications.

Public involvement in the SPS CDEP consisted of an experimental effort to acquire feedback about the SPS concept from the constituents of three public interest groups: Citizen's Energy Project (CEP), Forum for the Advancement of Students in Science and Technology (FASST), and the L-5 Society (L-5). The objectives of this outreach effort were to determine the initial response and reaction to the SPS concept by each group, determine the areas of major concern relative to the SPS concept, and gain experience of an outreach process for use in future public outreach efforts. The steps involved in the outreach effort are presented in Figure 1.

Each group summarized 20 SPS White Papers and distributed them to 3,000 constituents with a request for feedback. The methods to accomplish these tasks were independently chosen by each group. Therefore, the kinds of information received, both qualitatively and quantitatively are a result of the methods used to obtain this information and are different for each group.

Each group also identified the most frequent questions asked by respondees. These questions were condensed and combined, totalling 44, which were sent out to the SPS Research and Development (R & D) Task Force for answers. The questions and answers have been printed by DOE and sent to interested individuals in all three groups. Each group has also requested feedback from their respective constituents who are recipients of the questions and answers.

The outreach program was a successful program of public involvement and participation in the SPS CDEP evidenced by the following results: 1) 9,200 individuals/organizations received information about the SPS concept; 2) approximately 1,400 recipients of this information took the initiative to provide feedback (15%); 3) major concerns, fears, risks and benefits of the SPS concept as perceived by respondents were identified; 4) the values of each group and their position relative to SPS were identified; 5) the DOE/SPS Project Office, R & D Task Managers and contracted field researchers learned of the concerns and questions of the respondents.

A review of other federal programs for public involvement suggests that the SPS public outreach is unique and unprecedented. The differentiating circumstances

are: SPS is an advanced technological concept in embryonic stages of development; SPS has a scope of impact that reaches world proportions; there are many potential stages of R & D necessary before a close proximity to a go/no go decision is reached. It is a complimentary adjunct to the SPS Participatory Technology Process, a unique characteristic of the SPS CDEP.

Other studies in public involvement include a study of "Student Participation" conducted by FASST to investigate methods and techniques most appropriate for student involvement in SPS Program development, and a study of the "Energy Implications of an Aging Population," by A. Cambel and Associates of George Washington University.

A strategy for future public participation is currently being developed, modeled after the public outreach effort. Elements of the strategy have been identified, including the goals/objectives, target participating publics, critical issues, program tasks and methods and techniques to accomplish program tasks.

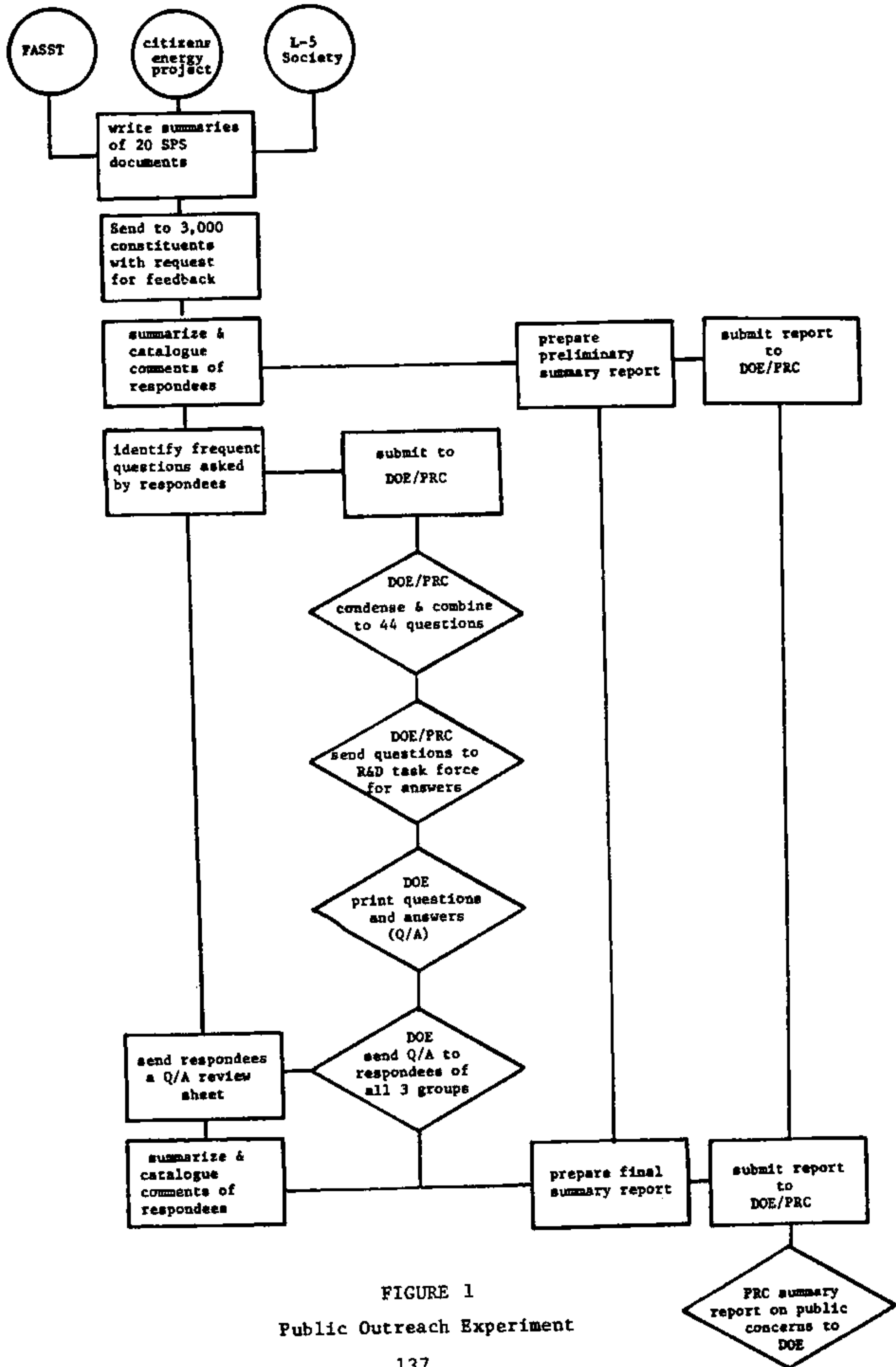

FIGURE 1
Public Outreach Experiment

A METHODOLOGY FOR THE COMPARATIVE ASSESSMENT OF THE SPS
AND ALTERNATIVE TECHNOLOGIES

Thomas D. Wolsko

Argonne National Laboratory - Argonne, Illinois 60439

The objectives of the comparative methodology are to 1) establish a framework of assessment information that incorporates different comparative viewpoints, 2) develop a classification system in which the environmental, social, and economic issues can be grouped into meaningful categories for the decision maker, 3) identify the units of measure that are used to compare the environmental, social, and economic issues, 4) establish quantitative and qualitative strategies (approaches, methods, models) of data collection and analysis for an issue assessment, and 5) identify sources of data for the comparative assessment.

Figure 1 shows the phased sequence of analytical steps that make up the framework for the comparative assessment. The first step in the process is the selection of issues and energy alternatives. Table 1 shows the candidate list of technologies from which the comparative alternatives were selected. The seven technologies with the asterisk were selected for comparison to SPS. The following criteria were used to arrive at the reduced list of energy alternatives shown in Table 1.

- Energy output must be in the form of electricity.
- Commercial availability should be possible in the year 2000.
- The technology must have the capability for baseload operation.
- The technology must have an available source of fuel for many years after the year 2000.
- Design information on the technology must be available.

These criteria allow the inclusion of currently used technologies that have improved performance as well as the selection of new technologies that are being developed or technologies that are still at the conceptual stage (those for which little engineering design information exists). Some of the technologies do not meet all of the criteria but were selected because they provided an important comparison to SPS.

Issues arising from the deployment of SPS and the alternative terrestrial power systems are identified and described in the process of comparative issues selection. The issues taxonomy must be general enough to accommodate differences among the alternative technologies and specific enough to be truly commensurable. Since microwave energy is not a feature of any of the alternatives that might be selected for comparison with SPS, the issues cannot be described simply along the lines of microwave problems. Therefore, the approach taken here is to define comparative issues in terms of the stakeholder concerns, that is, climate, welfare, and health and safety issues.

Figure 2 illustrates the taxonomy that was devised for comparing technologies. The issues are grouped under five major categories: cost and performance, environmental, economic/societal, resource, and institutional. The definitions of some of these categories are unique to this methodology and therefore should not be confused with definitions reported elsewhere.

The issues grouped under cost and performance concern the cost of construction, operation, and maintenance of an energy system, in terms of both capital costs and of operation and maintenance costs. Included in this group are system performance issues, e.g., the reliability.

Environmental issues are divided into two subcategories: those that directly concern public and occupational health and safety and those that do not directly concern these areas (welfare). For example, damage to buildings from air pollution, loss of radio-frequency communication due to microwave interference, changes in land values resulting from deployment of an energy technology, and crop damage due to air pollution.

Socioeconomic effects resulting from technology deployment (e.g., temporary and permanent shifts in population, near-term services, and employment opportunities) and macroeconomic issues like balance of trade, effect on the gross national product, and capital demands make up the Economics/Societal section. Institutional comparisons deal with the effects of existing institutions on the deployment of a technology (regulatory impacts). The resource category includes five subcategories: land, labor, materials, energy, and water. Here, key concerns include resource limits, production limits, degree of foreign dependency, and need for new skilled labor.

Side-by-side analysis tabulates normalized (per MWe) effects of each technology. Because of its static nature it must make certain assumptions about the national economic state of the world. The next step in the methodology is the alternative futures analysis that treats most of the economic conditions as variables and creates a parametric comparison based on different plausible energy supply/demand futures. The last step in the process is an assessment dimension reduction step that would focus the comparative dimensions to the key issues via a formalized process.

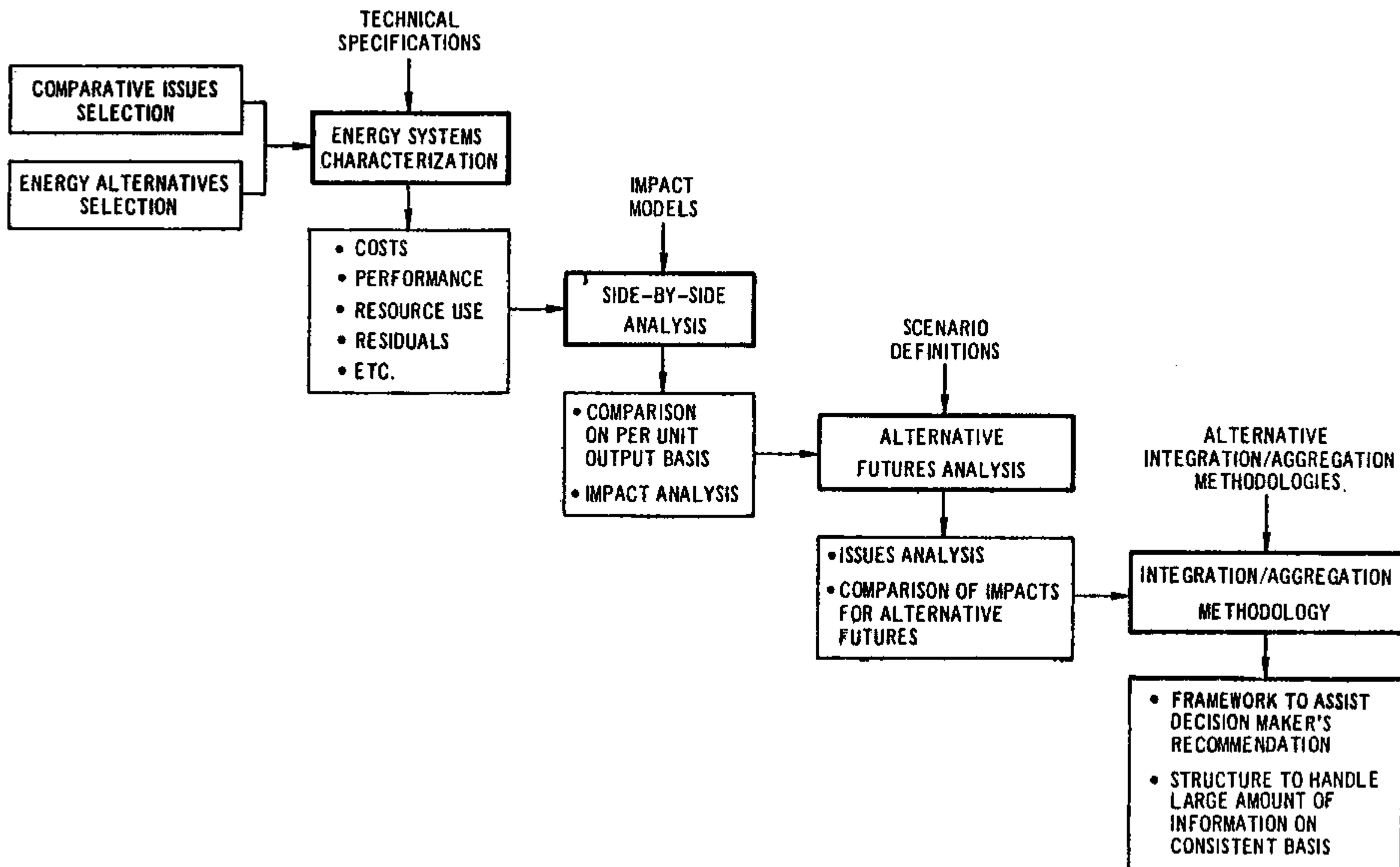

Fig. 1 Analytic Sequence for the Comparative Methodology

Table 1. Candidate Alternative Technologies

Fossil-Fueled

- Gas
- Oil
- *Coal/Stack Scrubber
- Coal/Fluidized Bed
- *Coal-Gasification/Combined-Cycle (CG/CC)
- Coal/Magnetohydrodynamics (MHD)
- Molten Carbonate Fuel Cells with Gasifier

Geothermal (steam, water, hot rock)

Nuclear

- *Light Water Reactor (PWR)
- LWR [Plutonium (Pu) Recycle]
- *Liquid-Metal, Fast-Breeder, Reactor (LMFBR) [Plutonium/Uranium (Pu/U); Uranium/Thorium (U/Th)]

Solar

- Terrestrial Photovoltaic (*centralized and *decentralized)
- Solar Thermal
- Wind
- Biomass
- Ocean Thermal Energy Conversion (OTEC)
- Solar Heating & Cooling
- Process Heating & Cooling

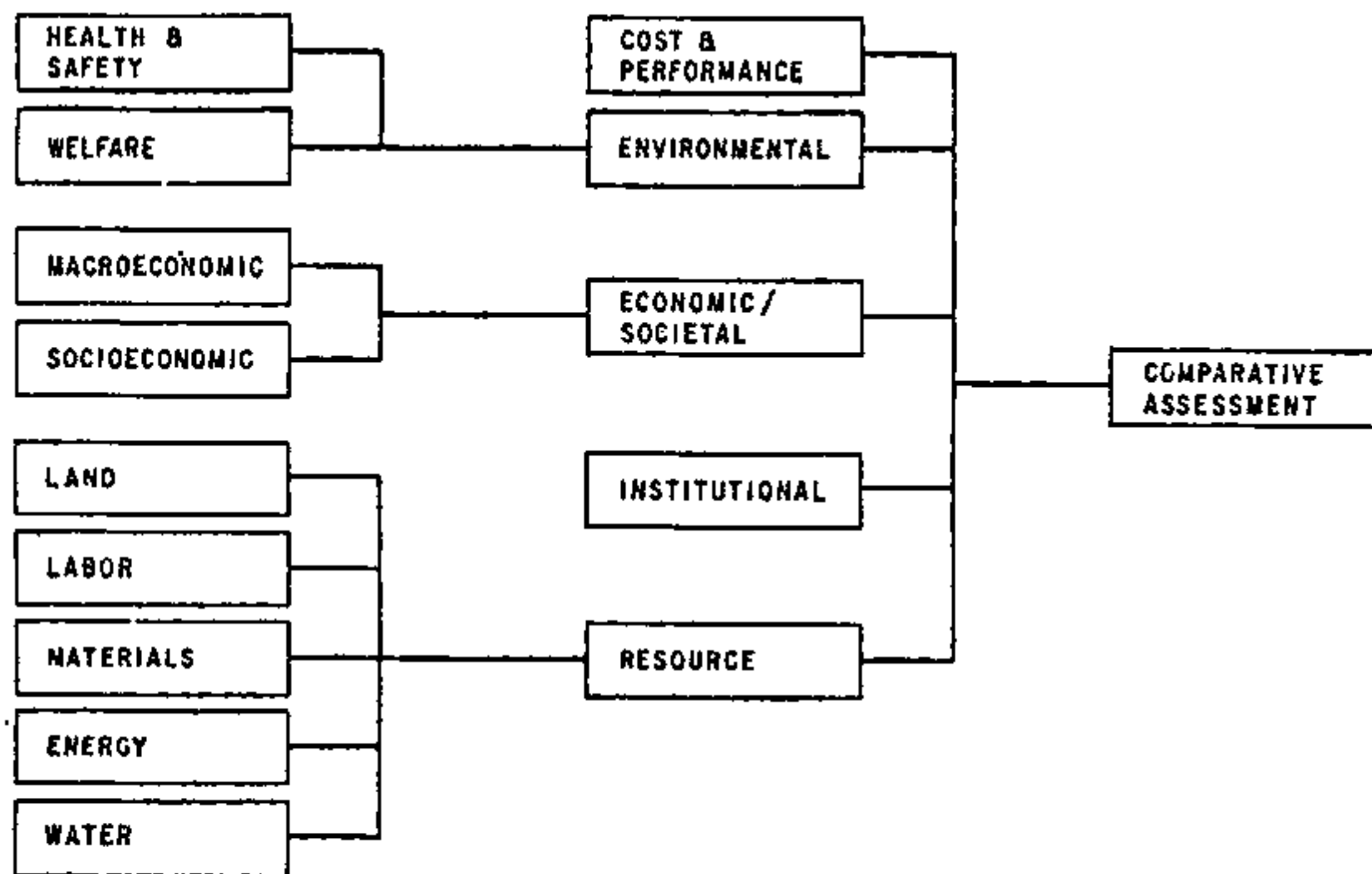

Fig. 2 Comparative Assessment Taxonomy

REFERENCE SYSTEM CHARACTERIZATION AND COST OVERVIEW

Robert O. Piland

NASA/Johnson Space Center - Houston, Texas 77058

Studies conducted during the Solar Power Satellite Concept Evaluation Program have considered a variety of system design approaches. Each of these design approaches has advantages and disadvantages. Considerable additional work would be required before a final or preferred system can be defined. For the immediate purposes of the evaluation program, however, a reference system has been defined to provide a basis for assessing alternate technical approaches, environmental factors and to serve as a basis for preliminary cost studies.

Reference System Description

A description of the system is presented in reference 1. Major elements of the system are depicted in figure 1. They include a cargo launch vehicle, a low earth orbit staging base, a cargo orbital transfer vehicle, a geosynchronous construction base, and the energy system consisting of the satellite and a ground receiving station or rectenna. Additional program elements include personnel launch and orbital transfer vehicles, launch and recovery facilities, and industrial production facilities. More detailed characteristics of the satellite and rectenna are presented in figure 2. The satellite consists of the solar array and the microwave transmitting antenna. The solar array includes a graphite composite truss structure and a blanket of silicon solar cells. An alternate reference option involves the use of gallium aluminum arsenide solar cells in a trough-like structure. A yoke arrangement provides the interface between the solar array and the transmitting antenna. Its mechanization allows the solar array to track the sun while the antenna tracks the rectenna at a fixed position on the earth. The antenna consists of a primary and a secondary structure, on which are mounted approximately 7000, 10 meter by 10 meter, subarrays. The subarrays include 100,000 DC-RF power amplifiers and wave guides. The rectenna consists of a series of panels, oriented toward the satellite, consisting of an open-screen ground plane, on which are mounted a large number of half-wave dipole antennas. The power, collected by the antennas, is fed to Schottky barrier diodes for conversion to D.C. power. The dimensions of the satellite and rectenna are shown in the figure. The satellite weighs 51,000 metric tons.

Cost Overview

The detailed definitions of the satellite, rectenna and other program elements have provided basic information necessary for preliminary cost estimates. A number of estimates have been developed during the Concept Evaluation Program; however, the concept has not matured sufficiently to establish an official estimate. The estimates presented, however, are illustrative, and have been found to be useful in establishing the relative importance of the various program elements from a cost standpoint.

Figure 1

NASA

Solar Power Satellite

Major Program Elements

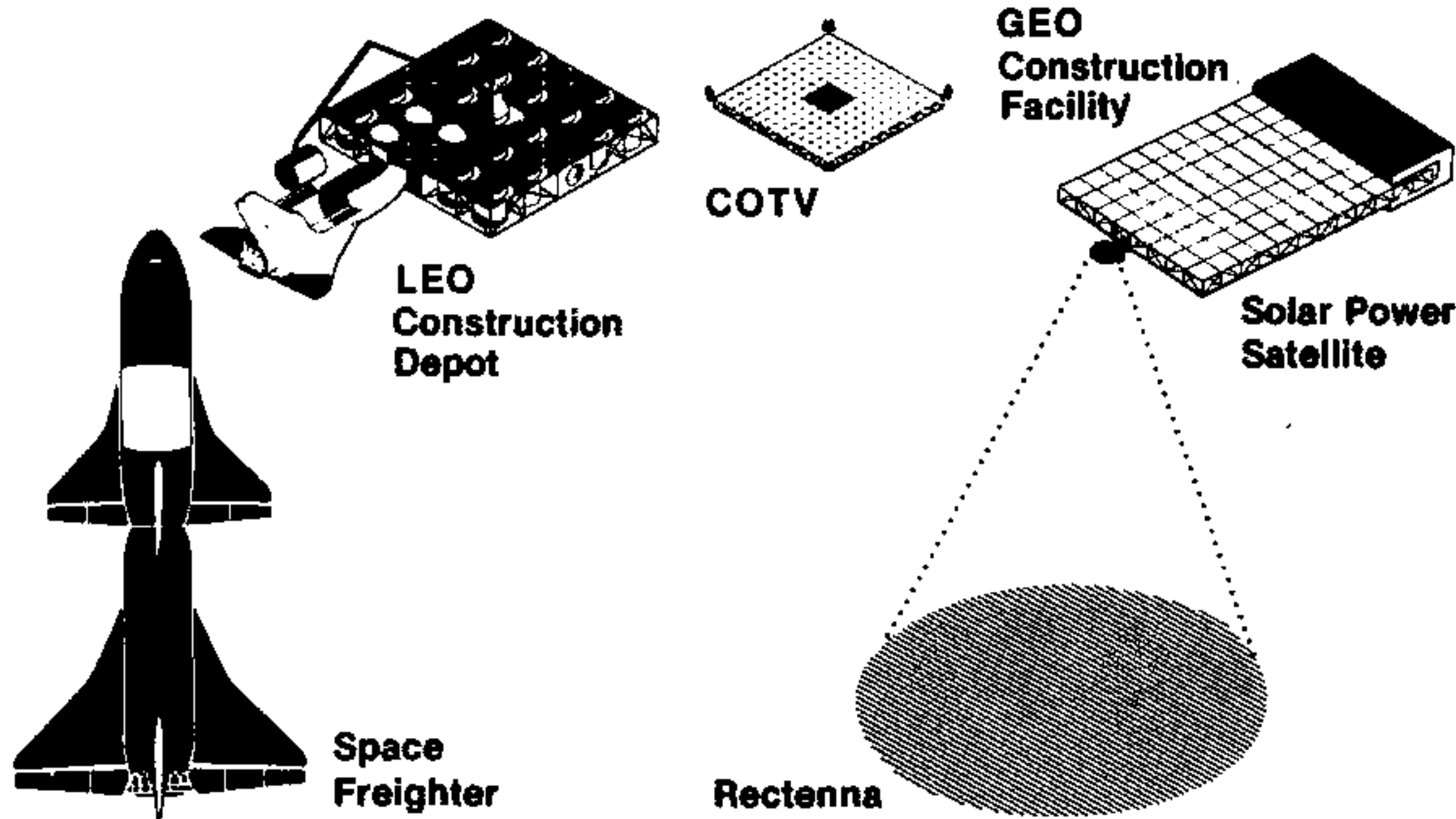

Figure

NASA

Solar Power Satellite

Reference System Characteristics

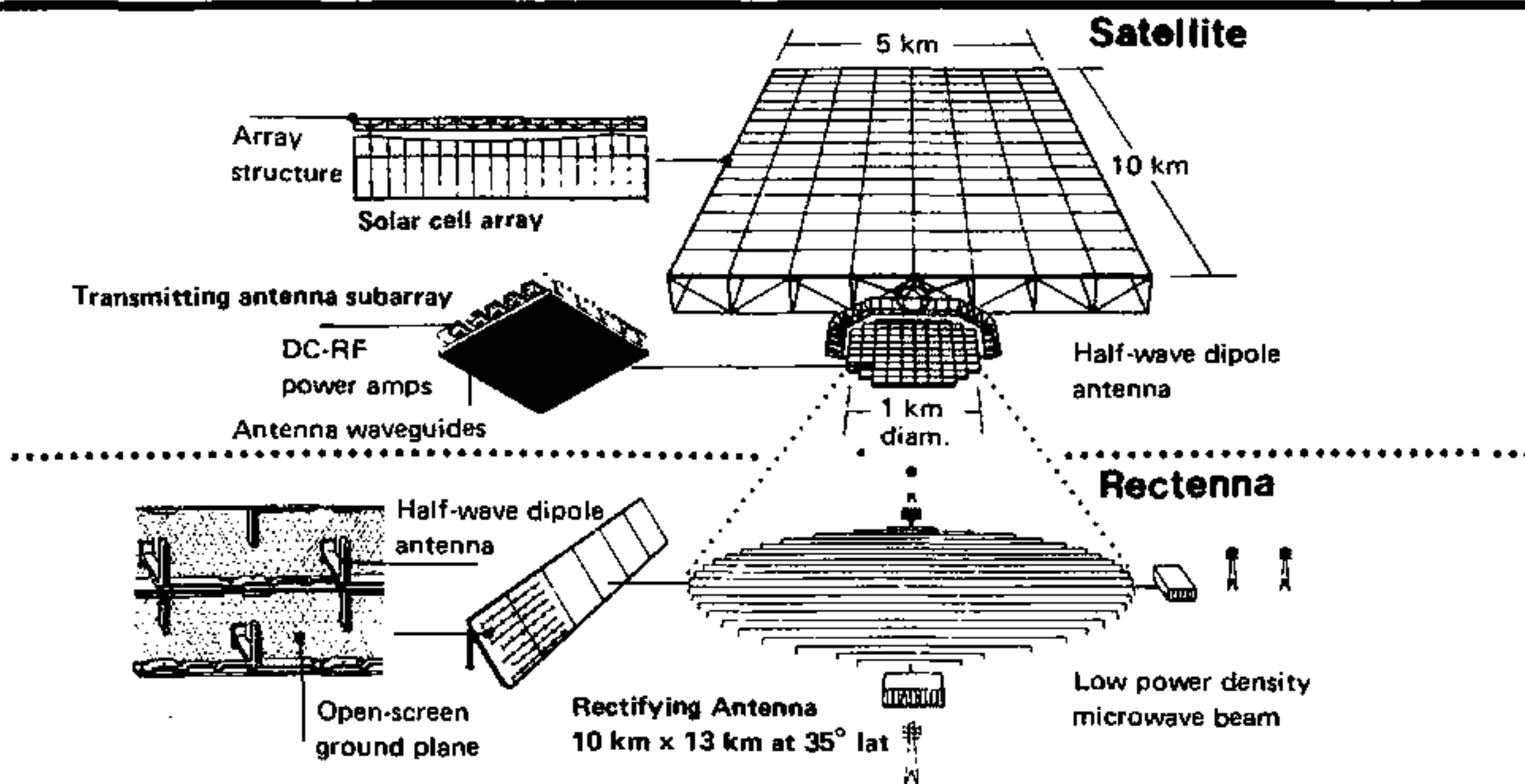

Two cost perspectives are necessary for concept evaluation. The first involves the total cost necessary to research, develop, facilitate, and construct the first full-scale system. The program phases involved in achieving this first unit and the associated costs are discussed in reference 2. The second perspective involves the cost of replicating the initial system and thereby increasing the total power available.

The work breakdown structure presented in table 1 has been utilized in developing the cost estimate. The actual structure used involves many more levels of detail than portrayed in the table. Cost estimating procedures have included conventional estimating relationships based on existing data bases coupled with a "mature industry approach" where very large production quantities are involved.

The satellite costs are those required to produce the 51,000 metric tons of material and components in earth-based facilities. Construction costs include the funds required to maintain and operate the space staging and construction facilities including salaries and supplies for the construction crews. The transportation costs involve the operation of fleets of four types of vehicles ferrying crews and cargo to the space construction facility. The rectenna costs include both the cost of the materials and components and the associated construction costs. Maintenance costs include the crews and components, transportation and facilities necessary to service the satellite and the rectenna, after operations are initiated.

Table 2 presents a summary cost estimate for a particular program scenario, involving the construction of two-five gigawatt systems per year over a thirty-year period. Cost estimates are presented for each program phase leading up to the first full-scale unit and the average cost of the succeeding fifty-nine units. The relative cost of the energy system, construction, transportation, and program management costs are presented.

Concluding Remarks

Accurate cost estimates for any advanced energy systems are very difficult to develop, since such estimates require technology advancement projections over an extended period of time. Nevertheless, such estimates are necessary to the preliminary evaluation of advanced concepts. The primary value of such estimate is to provide an indication of whether the concept should be pursued relative to other concepts, and to evaluate the relative cost importance of the various elements contained within the program.

The estimated costs presented in table 2 were obtained from studies conducted by the Boeing Aerospace Company as part of the SPS System Definition effort.

- Reference 1. Reference System Report, Satellite Power System Concept Development and Evaluation Program, Department of Energy and the National Aeronautics and Space Administration, October 1978.
- Reference 2. Piland, R.O. SPS Cost Methodology and Sensitivities. Satellite Power System Program Review, Department of Energy and the National Advisory Committee for Aeronautics, April 1980.

Table 1
Work Breakdown Structure

1.0 SPS PROGRAM

- 1.1 Satellite
 - 1.1.1 Conversion
 - 1.1.2 Transmission
 - 1.1.3-7 Other
- 1.2 Construction
 - 1.2.1 GEO Base
 - 1.2.2 LEO Base
 - 1.2.3 Maint. system
- 1.3 Transportation
 - 1.3.1 Cargo launch
 - 1.3.2 Cargo OTV
 - 1.3.3 Personnel launch
 - 1.3.4 Personnel OTV
 - 1.3.5 Ground Operations
- 1.4 Rectenna
 - 1.4.1 Site
 - 1.4.2 Structure
 - 1.4.3 Power collection
 - 1.4.4 Control
 - 1.4.5 Interface

145

Cost Elements	Major Program Phases						
	Res.	Eng.	Demo.	Invest.	1st SPS	Total	Avg. SPS
Satellite/ Rectenna	.3	.7	7.5	9.5	6.5	24.5	6.5
Construction	.05	2.3	8.8	17.0	1.8	30.0	1.0
Transportation	.05	5.0	6.5	30.0	4.0	45.5	2.8
Mgmt. & Integ.		.1	.2	1.0	1.2	2.5	1.2
Total	.4	8.1	23.0	57.5	13.5	102.5	11.5

Table 2
A Program Cost Scenario*

*All Costs in Billions
of 1977 \$*

** No official estimates exist.
This is one of several estimates.*

SPS AND ALTERNATIVE TECHNOLOGIES COST AND PERFORMANCE EVALUATIONS

Michael E. Samsa

Argonne National Laboratory - Argonne, Illinois 60439

An important consideration in the analysis of the Satellite Power System (SPS) concept for electrical energy production early in the twenty-first century is its expected generation cost in comparison with that for alternative technologies. This study uses, as a standard metric, the constant dollar levelized annual revenue requirement for production of a unit kilowatt-hour of electrical energy from each system as the basis for comparison. Levelized annual revenue requirement, expressed in mills/kWh, is essentially a discount factor weighted average unit cost of energy production which includes all components of capital recovery, fuel, and nonfuel operating cost projected over the facility's economic lifetime. A typical utility's weighted average cost of capital, exclusive of general inflation, was selected as the appropriate discount rate.

Analysis of future costs is complicated by the existence of large uncertainties about capital and fuel prices twenty to fifty years in the future. This uncertainty originates from three major concerns: 1) uncertain performance capabilities and capital costs for improved current, near-term, and advanced technologies, 2) uncertain future economic trends and their effect on energy demand, and 3) uncertain future regulations that may constrain certain fuel production or use. Each of these factors is accounted for in the analysis.

Table 1 displays the low, nominal and high capital costs projected for each technology for the year 2000. As shown, these costs derive from the direct and indirect capital cost estimates made as part of the technology characterization task by adding costs for contingencies, owner's expenses, and interest during construction. These additions result in a nominal 1978 costs. Projection of these costs to the year 2000 consider ranges of uncertainty in future environmental regulations, safety requirements and technological advances. Low year 2000 costs for coal and nuclear systems assume optimistic projections of future environmental and safety requirements, respectively. Low costs for the central station photovoltaic and SPS technologies assume a reduction in solar cell costs from the nominal \$37.80/m² (1978) to \$21.60/m² (1978). High year 2000 costs are driven primarily by uncertainties in achieving the currently estimated nominal costs as a result of technical and regulatory uncertainties.

Figures 1 and 2 show the ranges of installed generating capacity and fuel prices that result from uncertainties in future economic trends and energy demand. Values shown are derived from the results of the alternative futures scenarios task. Examination of Figure 1 indicates that only the high capacity growth scenario (scenario UH) is capable of accepting a full implementation of sixty SPS units by 2030 if the SPS is limited to no more than twenty-five percent of installed capacity for utility operational purposes. In the lower capacity growth scenarios, UI and CI/CI(d), the SPS implementation rate would need to be reduced to one-half or one-third the nominal rate, respectively, in order to satisfy the twenty-five percent criteria in 2030. Although reduction of the SPS implementation rate would also reduce the up-front investment costs necessary to support it, only about half of the investment costs would vary proportionately; the other half would remain unchanged. Thus, as the SPS implementation rate is reduced, up-front investment adds significantly to the average

unit cost. As indicated in Table 1, reduced implementation could add as much as fifteen percent to the average unit cost, significantly offsetting potential major cost reductions, i.e., the sixty unit nominal year 2000 cost is comparable to the twenty unit low year 2000 cost for the SPS technology.

Figure 3 shows the ranges of levelized annual generation costs for SPS and the alternative technologies considered. The shaded area of each bar in Figure 3 represents the spread in nominal costs as a result of the spread of fuel price scenarios considered, except in the case of the terrestrial central station photovoltaic (TPV) where the range is defined by geographic location (Phoenix and Cleveland) and in the case of decentralized photovoltaics, where the indicated range is both location and design dependent. The low bound of each bar in Figure 3 represents the generation cost under the most favorable fuel price, location and/or design coupled with the low year 2000 capital cost. Conversely, the high bound represents the least favorable fuel price, location and/or design coupled with the high year 2000 capital cost.

Examination of Figure 3 leads to the following conclusions:

1. The SPS will have little chance of competing favorably, on a levelized cost basis, with improved conventional technologies over a wide range of fuel prices.
2. The SPS has a better chance of competing with near-term technologies, i.e. coal gasification/combined cost, high near-term technology cost assumptions.
3. The SPS may compete favorably with advanced technologies such as fusion, central station and decentralized photovoltaic. However, large uncertainties exist about the future costs of these systems.

Figure 4 shows the sensitivity of generation cost to variations in capacity factor for each of the central station technologies. The SPS, fusion and terrestrial photovoltaic systems are more sensitive to variations in capacity factor as a result of their higher capital intensity and essentially no variable fuel costs.

	Conventional Coal	Light Water Reactor	Coal Gasification Combined Cycle	Liquid Metal Fast Breeder	Central Station Photovoltaic	Fusion	SPS Reference System—Silicone			SPS Reference System—GaAl As		
							60 Units	30 Units	20 Units	60 Units	30 Units	20 Units
Unit Capacity (MWe)	1,250	1,250	2 @ 625	1,250	200	2 @ 660	5,000	5,000	5,000	5,000	5,000	5,000
1978 Nominal Cost (10 ⁶ \$)												
Direct	452.1	486.0	537.4	702.9	117.5	1,533.2	11,073	11,073	11,073	10,035	10,035	10,035
Indirect	90.7	197.1	132.7	262.6	20.0	628.7	464	464	464	464	464	464
Investment	-	-	-	-	-	-	1,793	2,730	3,678	1,793	2,730	3,678
Subtotal	542.8	683.1	670.1	965.5	137.5	2,161.8	13,330	14,267	15,215	12,292	13,229	14,177
Contingency	38.0	54.7	60.3	106.2	17.9	389.2	2,133	2,283	2,434	1,967	2,117	2,268
Owner's Costs	53.5	68.6	66.5	93.2	15.3	229.6	463	497	529	428	460	494
Interest During Const.	51.9	83.9	65.1	131.8	8.7	358.9	772	826	831	711	766	820
Subtotal	143.4	207.2	191.9	331.2	41.9	977.7	3,368	3,606	3,844	3,106	3,343	3,582
TOTAL 1978 Costs	686.2	890.3	862.0	1,296.7	179.4	3,139.7	16,698	17,873	19,059	15,398	16,572	17,759
1978 Nominal Cost (\$/KW)	549	712	690	1,037	844	2,378	3,340	3,575	3,812	3,079	3,314	3,552
Non-fuel O&M Costs (mills/kwh)	3.1	2.3	2.7	3.0	3.4/4.6 ^(b)	7.3	5.6	5.6	5.6	5.6	5.6	5.6
2000 Costs (1978 \$/KW)												
Low	647	886	813	1,291	731	2,378	3,139	3,374	3,611	2,874	3,109	3,346
Nominal	762	1,100	957	1,603	1,057	3,677	3,646	3,903	4,162	3,362	3,618	3,878
High	1,605	2,566	2,623	5,048	4,229	(a)	16,698	17,873	19,059	15,398	16,572	17,759
2000 Low/1978 Nominal	1.18	1.24	1.18	1.24	0.87	1.00	0.94	0.94	0.94	0.94	0.94	0.94
2000 Nominal/1978 Nominal	1.39	1.55	1.39	1.55	1.25	1.55	1.09	1.09	1.09	1.09	1.09	1.09
2000 Nominal/2000 Low	1.18	1.24	1.18	1.24	1.45	1.55	1.16	1.16	1.16	1.16	1.16	1.16
2000 High/2000 Nominal	2.11	2.33	2.74	3.15	4.00	(a)	4.58	4.58	4.58	4.58	4.58	4.58

(a) Physical Confinement not Proven

(b) Values for Phoenix/Cleveland

Figure 1

GROWTH OF ELECTRICAL ENERGY DEMAND WILL INFLUENCE RATE OF SPS IMPLEMENTATION

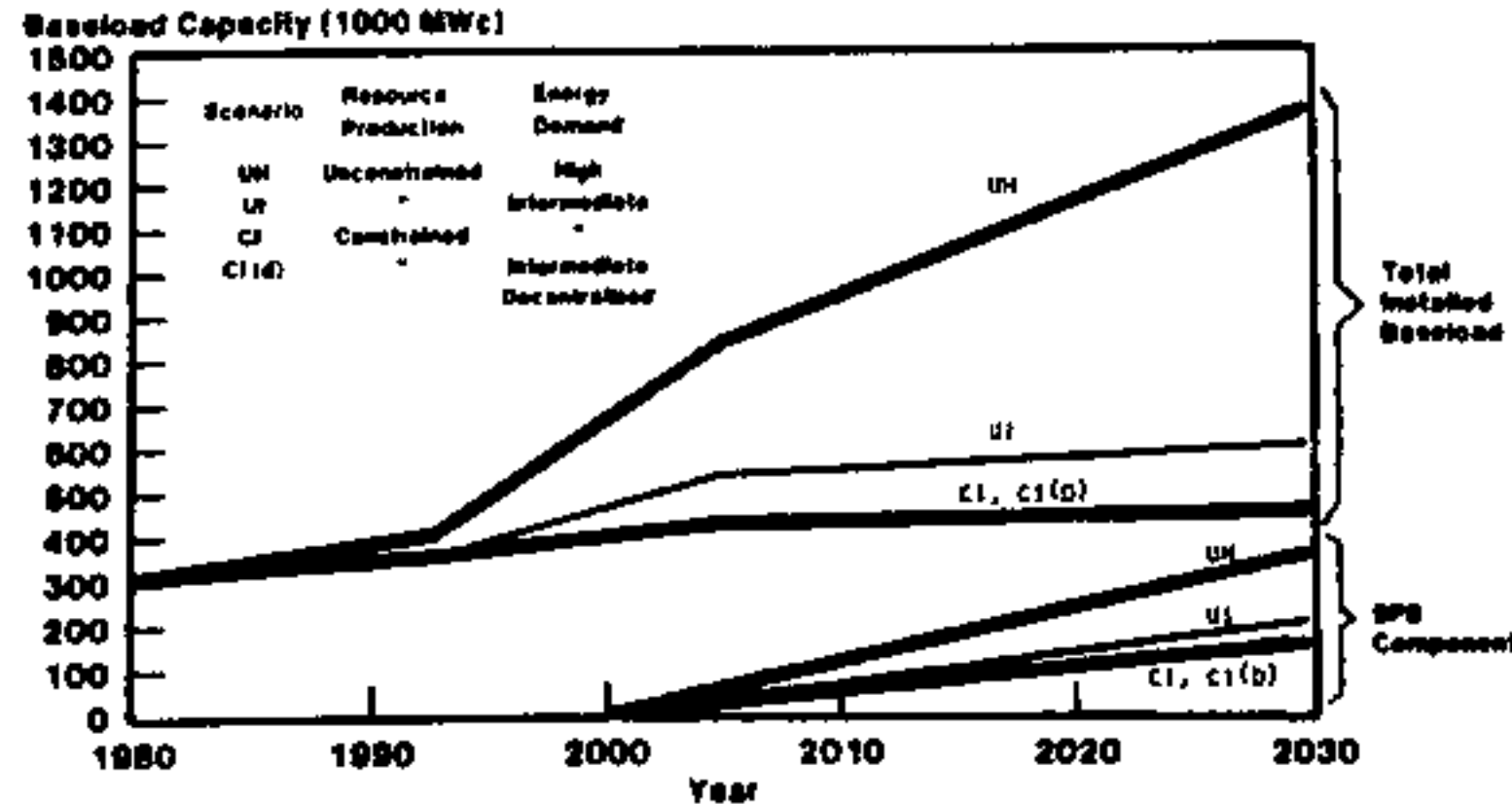

Figure 2

FUEL PRICE SCENARIOS SPAN A WIDE RANGE OF PROJECTIONS

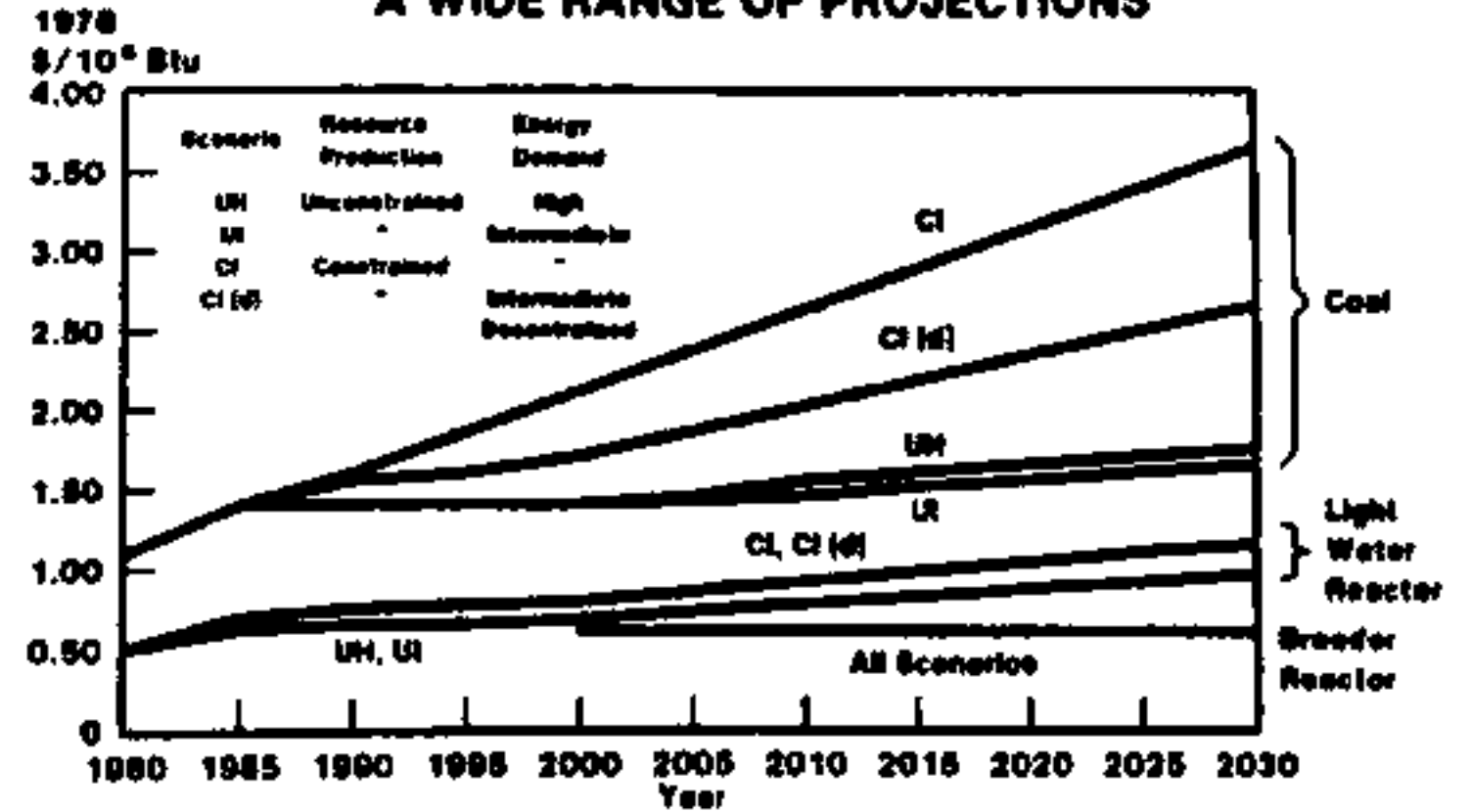

Figure 3

FUTURE CAPITAL AND FUEL PRICE UNCERTAINTIES RESULT IN A WIDE RANGE OF POSSIBLE GENERATION COSTS

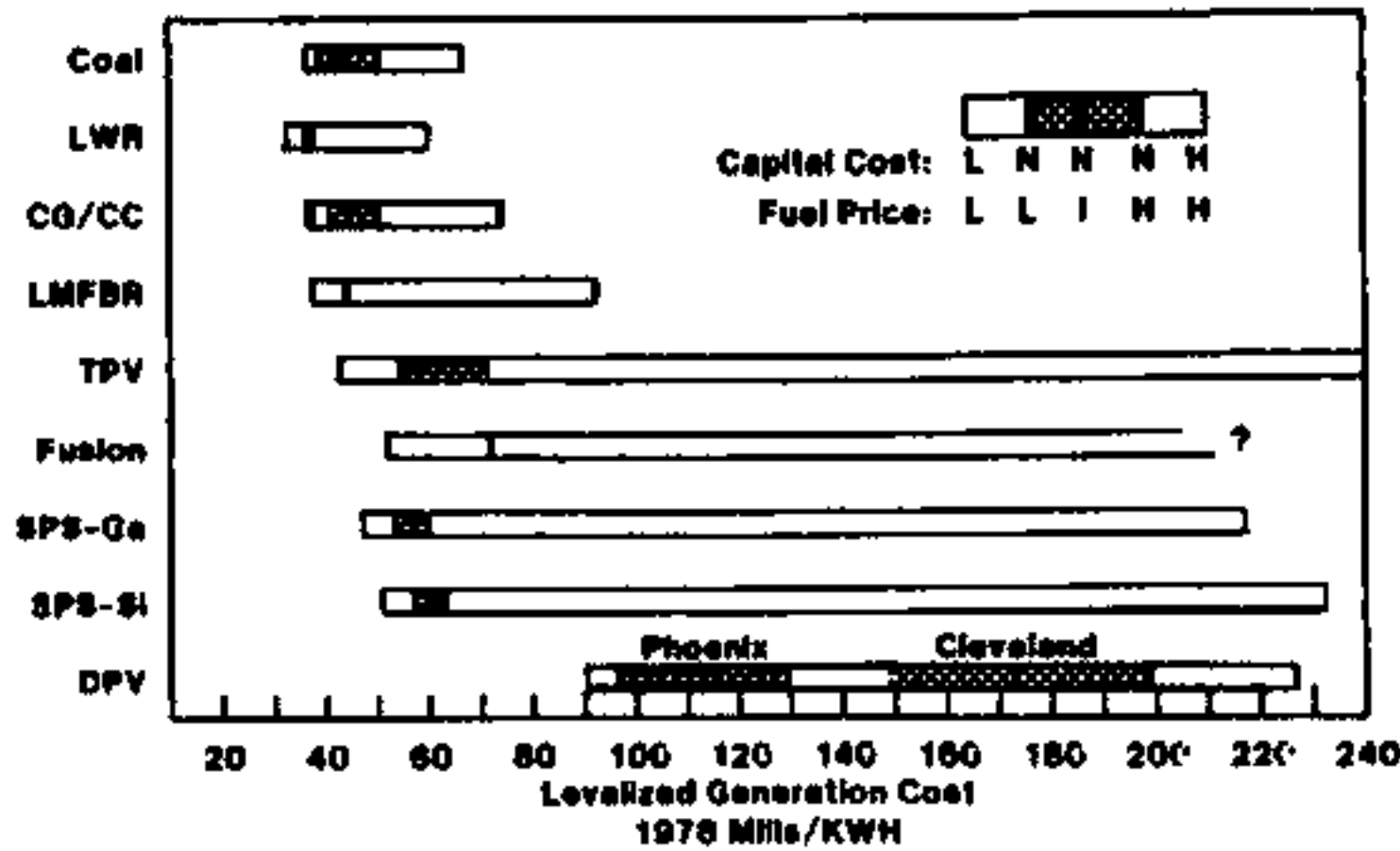
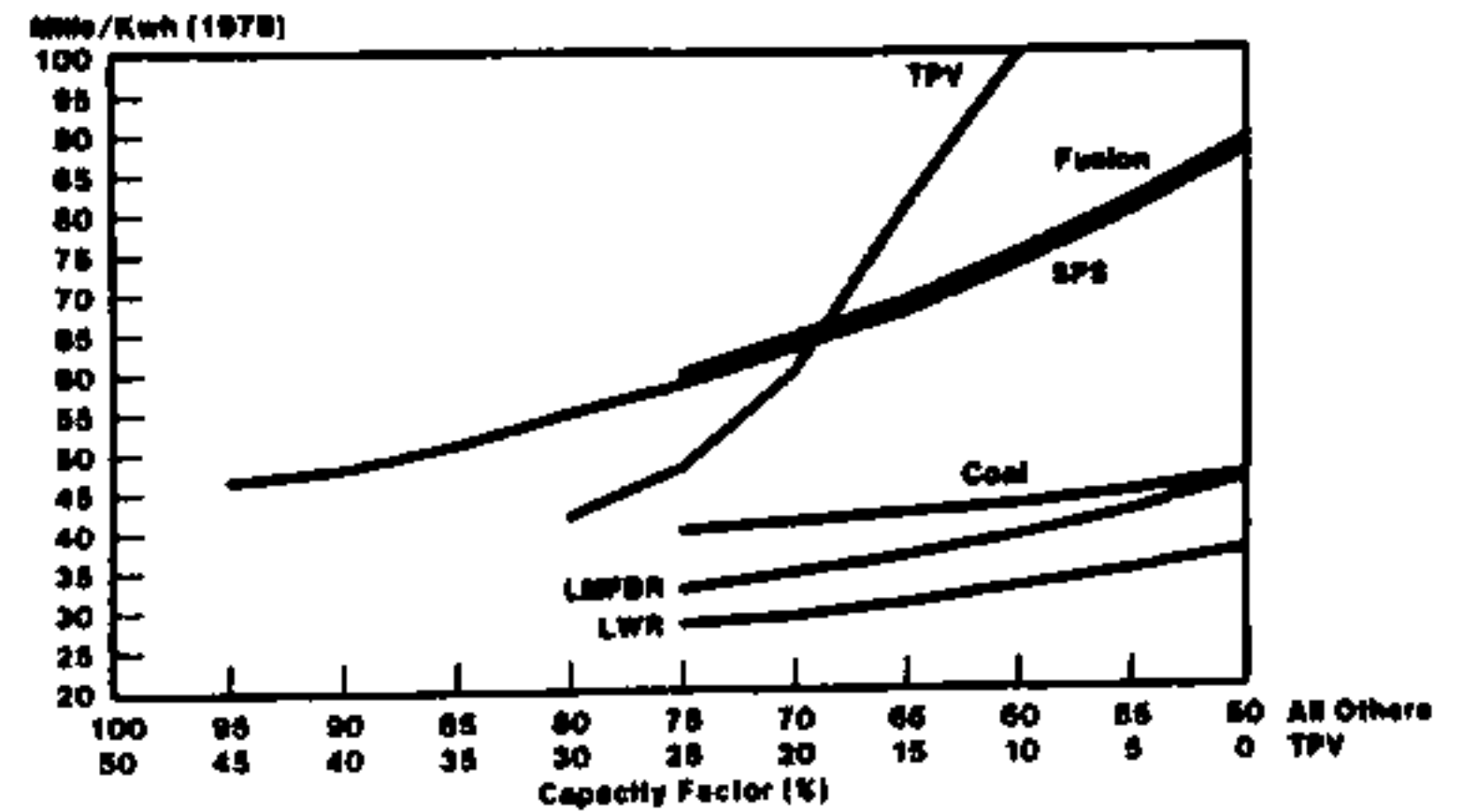

Figure 4

SPS, TPV AND FUSION GENERATION COSTS ARE MORE SENSITIVE TO CAPACITY FACTOR



COMPARATIVE HEALTH AND SAFETY ASSESSMENT OF THE SPS AND
ALTERNATIVE ELECTRICAL GENERATION SYSTEMS
L. J. Habegger - J. R. Gasper - C. D. Brown
Argonne National Laboratory - Argonne, Illinois 60439

A comparative analysis of health and safety risks is presented for the satellite power system (SPS) and five alternative baseload electrical generation systems: a low-Btu coal gasification system with an open-cycle gas turbine combined with a steam topping cycle (CG/CC); a light water fission reactor system without fuel reprocessing (LWR); a liquid metal fast breeder fission reactor system (LMFBR); a central station terrestrial photovoltaic system (CTPV); and a first generation fusion system with magnetic confinement. For comparison, risk from a decentralized "roof-top" photovoltaic system with battery storage (DTPV) is also evaluated. Quantified estimates of public and occupational risks within ranges of uncertainty were developed for each phase of the energy system on the basis of 1000 MWe average system output. A load factor of 70% was assumed for each system except the CTPV and DTPV for which 25% and 12% load factors, respectively, were used. Back-up energy systems were not included in the evaluation. More detailed system descriptions are provided in a companion paper.¹ Components of the analytical procedure are illustrated in Fig. 1. Also discussed in the paper is the potential significance of related major health and safety issues that remain unquantified.

For a comparative assessment that includes the more capital-intensive advanced technologies it is essential that risks from on-site construction and risks from both direct and indirect facility component production be evaluated. The latter indirect component production requirements (e.g., copper mining to produce electrical equipment) were obtained from 1972 input-output tables of the U.S. economy. As illustrated in Fig. 2, these indirect production risks comprise a significant fraction of the relatively large construction phase impact of the solar technologies. Although not shown, similar relative technology differences are obtained for non-fatal person-days-lost from occupational accident and disease.

The construction phase impacts, when averaged over an assumed 30-yr plant lifetime, bring the solar technology life cycle impacts to within the range of uncertainty of the quantified risks for the LWR, LMFBR, and fusion nuclear technologies (Fig. 3). The relatively large CG/CC risks per 1000 MWe-yr illustrated in Fig. 3 result primarily from public exposure to long-range transport of air pollutants (4-74 premature deaths; adapted from ref. 2), coal transport accidents, and coal mine disease and accidents. The relatively high risks of the DTPV system are related to the lower load factor and resultant higher material requirements, production risks for the storage batteries, and greater construction and maintenance requirements for the small, dispersed units.

In general, the more defined technologies (e.g., CG/CC, LWR) have a greater number of quantifiable risks and fewer unquantifiable risks. The opposite is true for the less-defined technologies (e.g., fusion, SPS). In contrast to the apparent public willingness to accept limited known risks of energy systems, recent experience with light water fission systems indicates that perceived major risks that are less quantifiable or predictable may restrict or completely halt energy system deployment if adequate assurances of very low impact probability cannot be given. For this reason potentially major, but unquantified, risks should be given prominence comparable to the quantified risks discussed above. Table 1 is a listing of potentially major unquantified issues

identified for the seven technologies considered. Catastrophic events (i.e., events of low occurrence probability, but high impact per event) are included in the unquantified category because of the inherent difficulty in predicting occurrence rate and impact level. Furthermore, averaging expected catastrophic impacts over plant lifetime does not indicate the full significance of these potential events. Table 1 does not attempt to rank the unquantified issues, although, for example, potential radiation release from fission is expected to be greater than that from fusion.

A further perspective on the significance of relative technology risks is provided by Fig. 4, which indicates the range of annual occupational risks for 2000-2020 scenarios of energy production with and without the SPS system. A nearly constant total electrical energy capacity is assumed in this period for the scenarios (Table 2). Because of high construction and manufacture and low operation and maintenance impacts, the SPS scenario has higher initial, but lower final occupational health and safety risks, as compared to the scenario without SPS. The quantified public risks, in particular those from coal, would favor the SPS scenario with reduced conventional generation. However, the unquantified risks to the public in Table 1 restrict the delineation of definitive conclusions related to total scenario risks.

References

1. Samsa, M., *Cost and Performance Review*, SPS Program Review, Lincoln, NB, April 22-25, 1980.
2. *An Assessment of National Consequences of Increased Coal Utilization*, TID-29425, Feb. 1979.

Table 1. Potentially Major Unquantified Issues Identified

<u>Solar Technologies (CTPV, DTPV, SPS)</u>	<u>Nuclear Technologies (LWR, LMFBR, Fusion)</u>
1. Exposure to Cell Production Emissions	1. System Failure with Major Public Radiation Exposure
2. Hazardous Waste From Disposal or Recycle of Cell Materials	2. Fuel Cycle Occupational Exposure to Chemically Toxic Materials
3. Chronic Low-level Microwave Exposure to Large Populations (SPS only)	3. Diversion of Fuel or By-product for Military or Subversive Uses (LWR, LMFBR only)
4. Space Vehicle Crash into Urban Area (SPS only)	4. Liquid Metal Fire (LMFBR, Fusion only)
5. Exposure to HLLV Emissions (SPS only)	
<u>Coal Technologies (CG/CC)</u>	
(None identified)	

Table 2. Energy Scenario Baseload Capacities (GWe)

Year	LWR	CG/CC	LMFBR	SPS	Fusion	Total
2000	263	238	34	0	0	535
2020 (SPS)	188	71	78	200	11	549
2020 (W/O SPS)	213	159	140	0	37	549

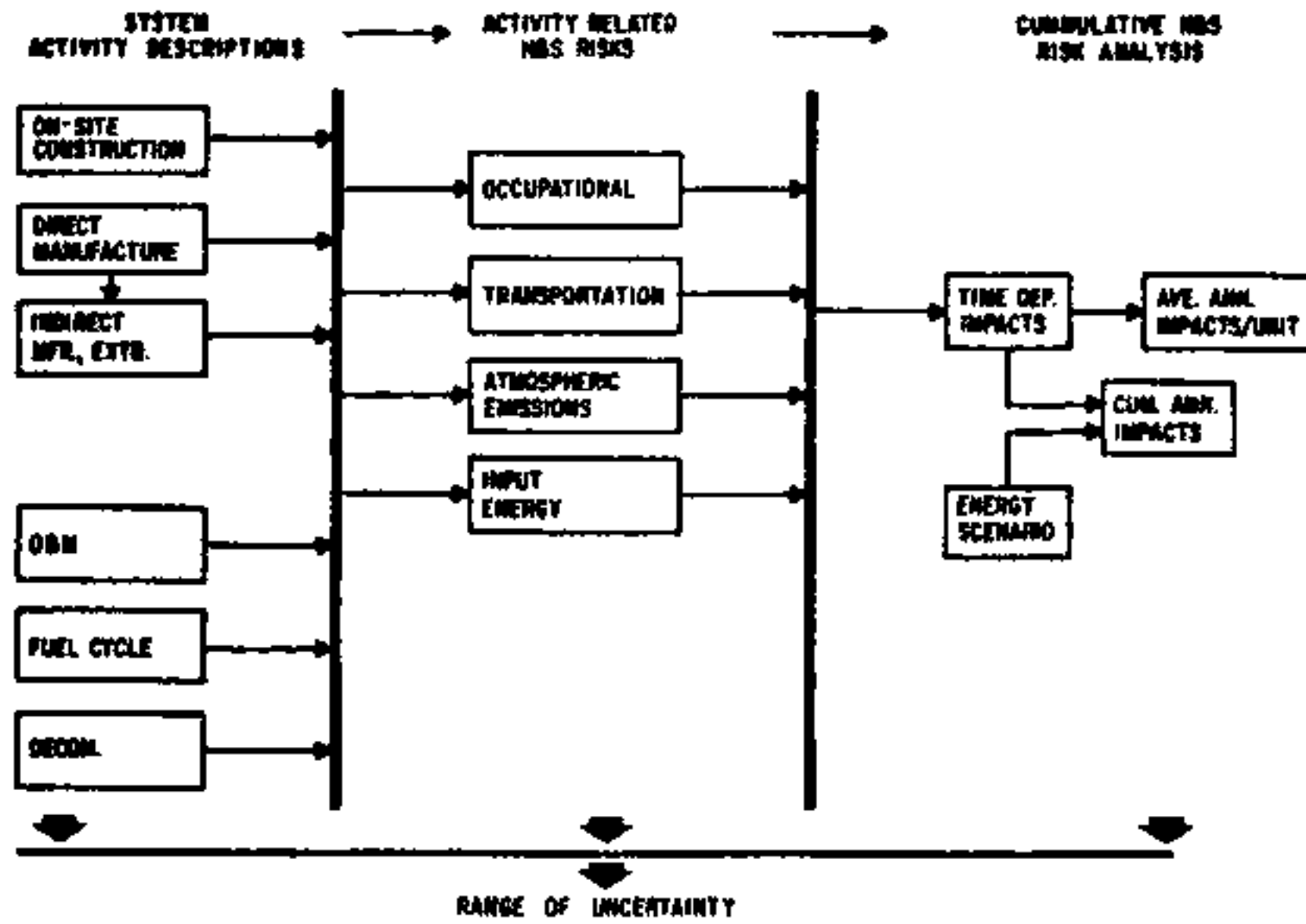

Fig. 1. Components for Comprehensive Energy Technology Health and Safety Risk Assessment.

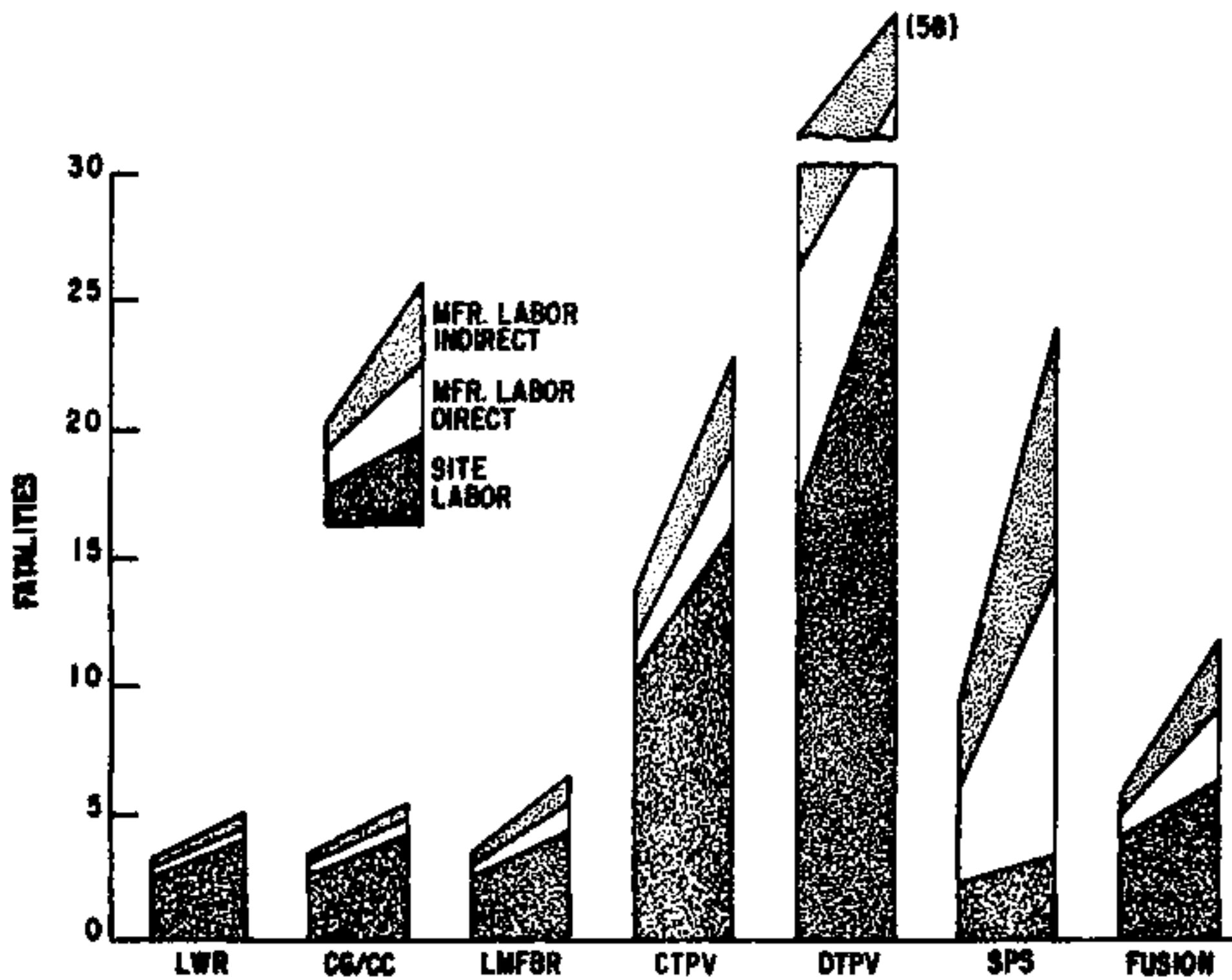

Fig. 2. Estimated Occupational Fatalities From Facility Construction and Manufacture for 1000 MWe Generation Capacity (Diagonal lines Represent Ranges of Estimates.)

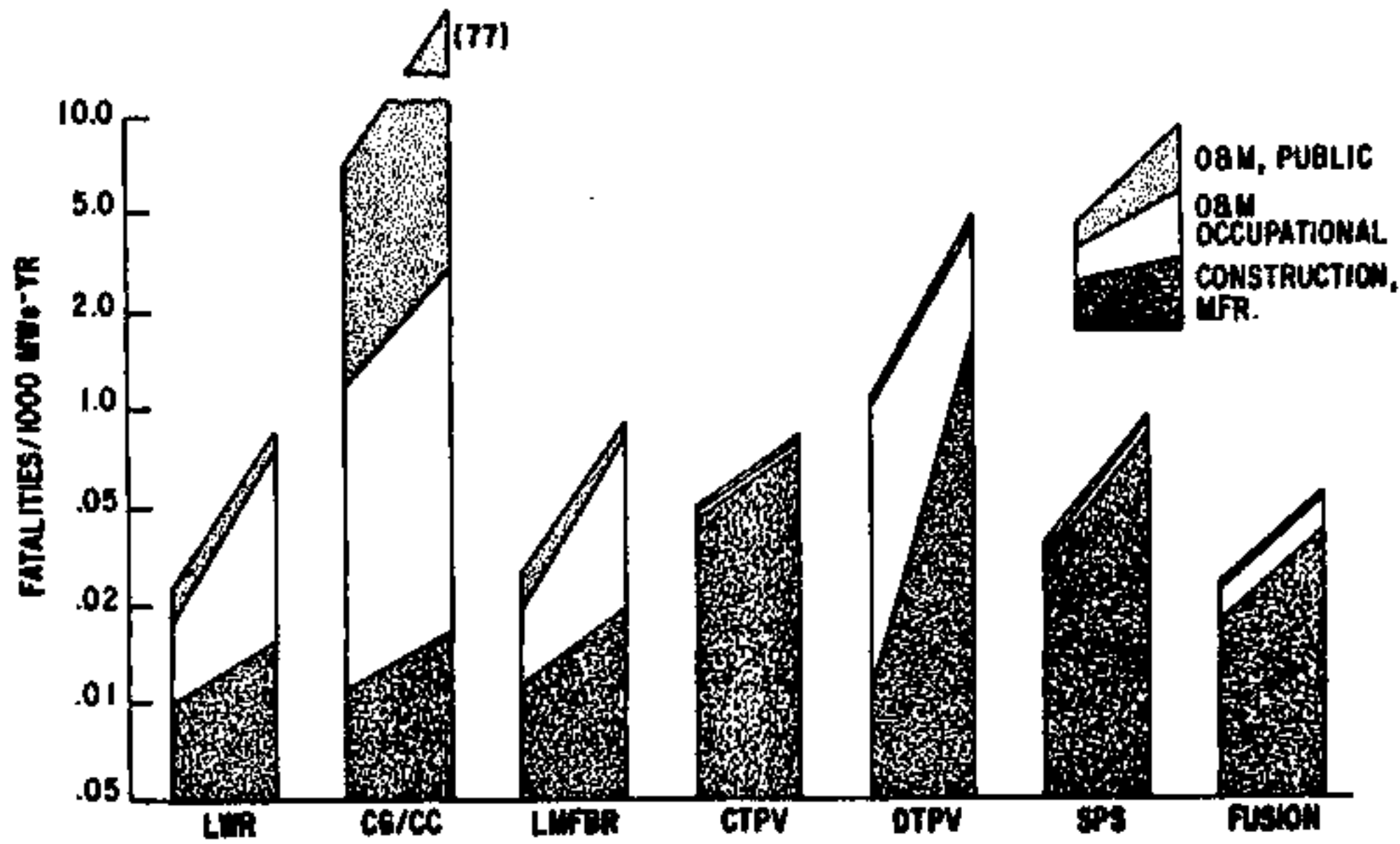

Fig. 3. Quantified Fatalities From Facility Manufacture, Construction, and O&M per 1000 MWe-yr (Diagonal lines represent ranges of estimates.)

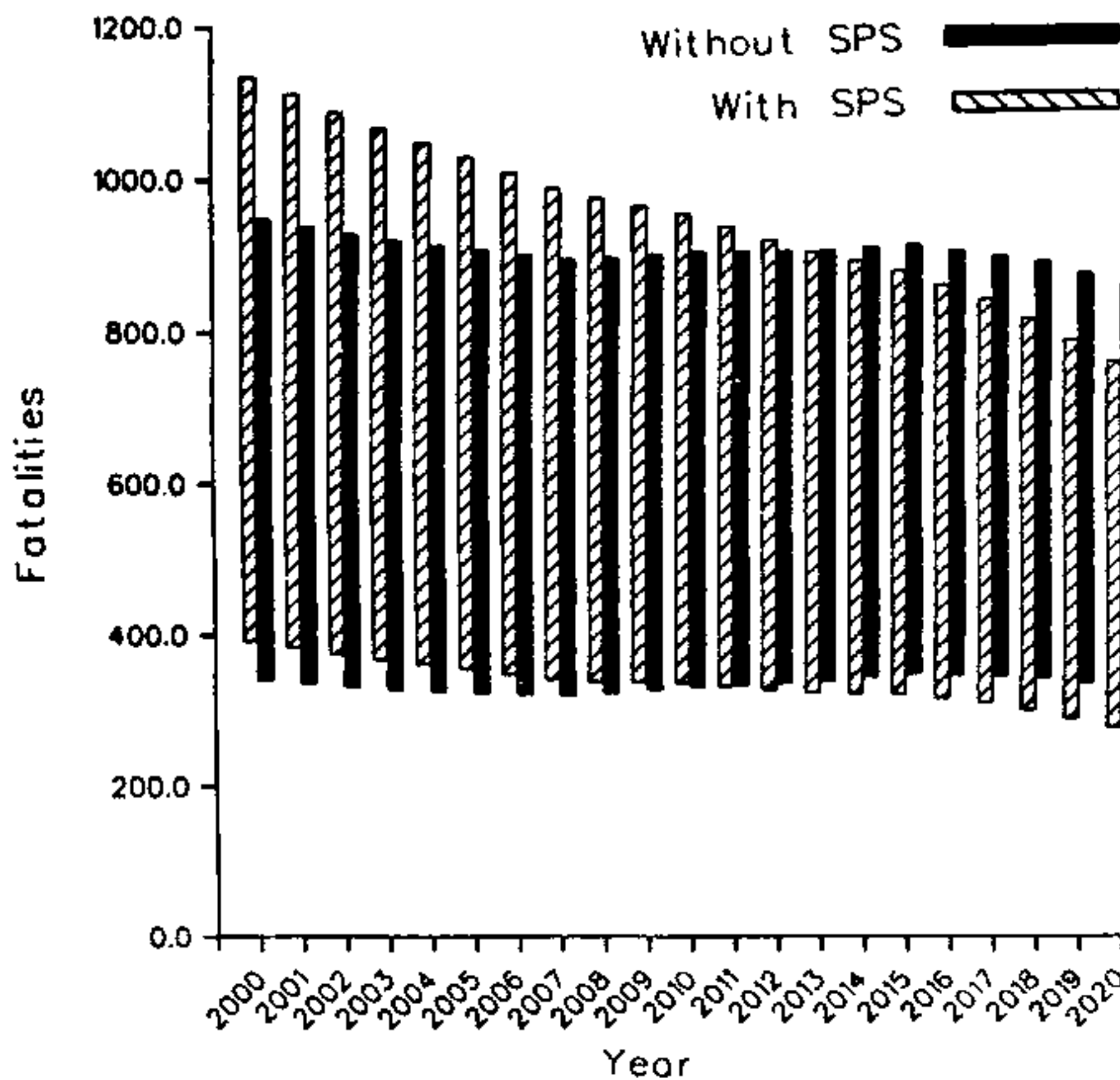

Fig. 4. Ranges of Quantified Cumulative Occupation Risks Related to a Scenario with Approximately Constant Electrical Generation With and Without SPS Implementation.

ENVIRONMENTAL WELFARE COMPARISON

Ronald G. Whitfield

Argonne National Laboratory - Argonne, Illinois 60439

Environmental welfare effects are defined as those effects from environmental degradation due to electrical power generation which are not directly related to public or occupational health and safety but concern the well-being of individuals. Studies were conducted to investigate pathways of energy activities which may cause environmental impacts and lead to welfare effects. Six activities contributing to the fuel cycle for eight energy technologies were defined, characterized, and studied in terms of resultant environmental impacts; welfare effects were classified into six categories. Study results include identification of priority welfare effects based on severity of occurrence and state of knowledge about uncertainty. These priority effects merit closer examination to reduce uncertainties and to develop mitigating actions.

An analysis was performed on two levels; first was a side-by-side analysis based on the emissions and residuals due to energy related activities of power generation plants rated at 1250 MWe; second was a scenario-driven alternative futures analysis intended to overcome the shortcomings of a side-by-side analysis by looking at a detailed mix of possible energy technologies in the future.

Not all environmental impacts result in environmental welfare effects. For example, the chemical discharge into a river is not a welfare effect in and of itself. However, if the chemical discharge results in smaller catches by commercial fishermen or prevents recreational uses of the river, the smaller catches and loss of recreational use would be welfare effects; the chemical discharge would then be considered a welfare-related environmental impact. On the other hand, if a person becomes ill after swimming in a river polluted by the chemical discharge the illness would be a health effect not a welfare effect.

Fewer potentially severe environmental welfare effects have been identified for nuclear options than for coal and solar options. Potentially severe environmental welfare effects identified which are due to air pollution from coal combustion include reduced crop yields, accelerated material deterioration, reduced visibility, reduced commercial/recreational use of waters degraded by acid rainfall. Also of concern is the release of toxic materials from the manufacture of solar cells and from SPS rocket launches.

Coal combustion contributes significantly to the total man-made input of carbon dioxide to the atmosphere and could augment the possible "greenhouse effect" of steadily increasing carbon dioxide levels in the atmosphere. Global temperature increases may be capable of altering precipitation patterns, agricultural production and ocean levels.

Water pollution due to underground coal mining, nuclear fuel fabrication, and solar cell manufacturing produce welfare effects including reduced drinking water quality, reduced commercial/recreational use of streams and lakes, and lowered crop productivity because of irrigation with degraded water. Fabrication of nuclear reactor fuel releases ammonia, nitrates, and fluorine at levels several orders of magnitude above those permitted by drinking water standards. While it is not known what effluents would be discharged from solar cell

manufacturing, this activity could have serious welfare effects because of the toxicity of the raw materials involved.

Surface mining of coal disturbs large areas of land and the productivity of reclaimed mine sites is often less than that of the undisturbed land. Disposal of high-level, transuranic, and low-level nuclear waste and uranium milling residues is likely to remove the affected land from any future use. Materials mining for solar cells and construction of SPS rectennas and launch sites would likely remove large areas of land from other uses and require the relocation of roads and services.

Electromagnetic disturbance of electronic systems as far as 100 km from an SPS rectenna site due to microwave interference could comprise a significant welfare effect. The severity of the electromagnetic interference would depend on the types of electronic systems impacted and their amenability to mitigating strategies that do not cause unacceptable operational compromises. Radio and optical astronomy might also be affected by the SPS.

Ecosystems within and near SPS rectenna sites would be exposed to chronic microwave radiation. While there is limited information on the effects of such exposure, the mortality, reproduction, and behavior of beneficial insects such as bees could be altered, possibly disturbing pollination of food crops.

Noise levels from SPS heavylift launch vehicles would be likely to exceed recommended EPA 24-hour average noise standards and elevate noise levels in communities as far away as 31 km. Launches would occur frequently causing welfare effects such as annoyance and interference with other activities. Land use changes and reduced property values would also be possible.

Some attention was given to alteration in the severity of welfare effects due to increased penetration of the various technologies. Penetration level will not in general become a significant factor causing severe welfare effects for most technologies until the spatial distance between sites becomes small. It is difficult to project such interactions in the absence of detailed siting information. However, it is rather safe to conclude that the climatic effects due to CO₂ become more likely with increased coal combustion. Also, there is the increased possibility of environmental welfare effects due to deployment of 60 SPS satellite-rectenna units. The possibilities of atmospheric alterations affecting communications systems and that increased levels of microwave radiation may affect crops and beneficial insects are not well-understood at the present time.

The environmental welfare effect most likely to have catastrophic consequences involves CO₂ buildup leading to global warming. Electricity generation from coal in the United States constituted only 5% of global CO₂ produced by man in 1977. The significance of this effect and all other environmental welfare effects must be kept in perspective and not overemphasized when comparing alternative technologies for producing electricity on a national level. It is recognized that there are potentially severe environmental welfare effects on a local/regional scale, but these are beyond the scope of the present study since they depend on specific siting information.

Potential Severity of and Status of Knowledge about Key Environmental Welfare Issues^{a,b}

Environmental Impacts with Possible Welfare Effects	Coal		Nuclear		SPS		Activities Causing Potentially Severe Welfare Effects
	Potential Severity	State of Knowledge	Potential Severity	State of Knowledge	Potential Severity	State of Knowledge	
Air Pollution	1	B-C	2-3	B	1	C	Coal-fired power generation (toxic and secondary pollutants). SPS materials manufacture and rocket launch.
Atmospheric Changes	1	B-C	4	B	3	B	Coal-fired power generation (CO ₂ emissions).
Thermal Discharges	2	B	2	B	2	B	--
Water Pollution	1	B	1	B	1	C	Coal mining (underground). Nuclear fuel fabrication. SPS materials manufacture.
Water Use	2	B	2	B	3	C	--
Solid Waste	2-3	A	3	B	2-3	C	--
Land-Use Disturbances	1-2	A	1	B	1	B-C	Coal mining (surface). Nuclear waste disposal. SPS materials mining, rocket launch, rectenna sites.
Electromagnetic Disturbances	1	B	3	B	1	B-C	SPS rectenna operation.
Microwave Radiation	4	B	4	B	1	C	SPS power transmission.
Ionizing Radiation	3	B	1	B	4	B	--
Noise	3	A	3	A	1	B	SPS rocket launch.
Aesthetic Disturbances	2	A	2	A	2	B	--

^aSeverity ranking is based on the most serious welfare effects of the activities within each fuel cycle. Potential severity is ranked according to the following criteria:

- | | |
|---|---|
| 1 - Very significant contribution to welfare effects. | 3 - Minor but measurable contribution to welfare effects. |
| 2 - Significant contribution to welfare effects. | 4 - Negligible contribution to welfare effects. |

^bState-of-knowledge ranking:

- A - Issue thoroughly documented and understood.
- B - Parts of issue understood, but gaps in knowledge exist.
- C - Very little knowledge of issue exists.

RELATIONSHIP OF FUEL CYCLE, ACTIVITIES, ENVIRONMENTAL IMPACTS, AND WELFARE EFFECTS

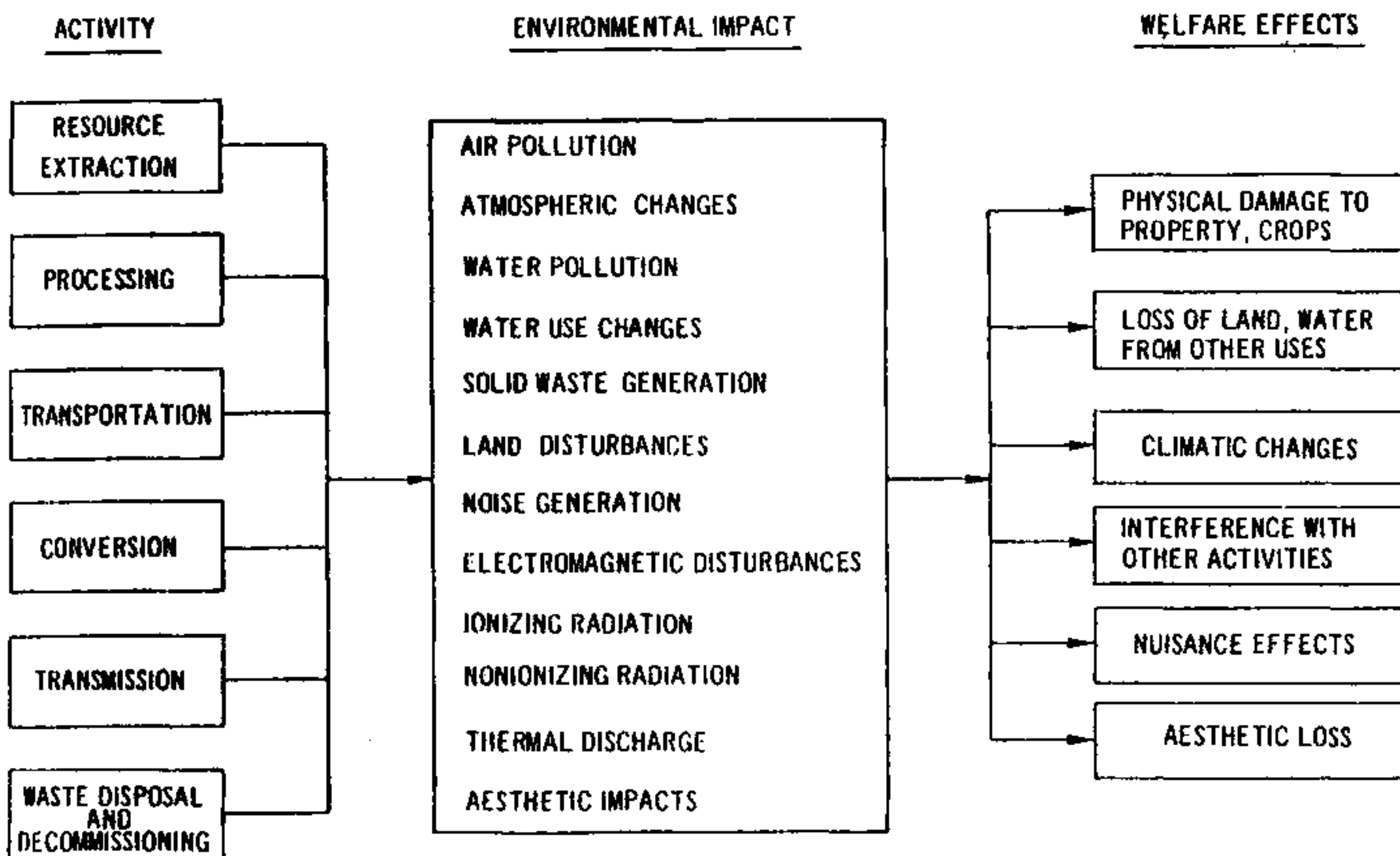

RESOURCES/MACROECONOMIC/INSTITUTIONAL COMPARATIVE ASSESSMENT

Ronald G. Whitfield

Argonne National Laboratory - Argonne, Illinois 60439

Three areas important in the Comparative Assessment of energy technologies are resource requirements, macroeconomic effects, and institutional considerations. Scenarios (alternative energy futures) developed as part of the SPS Concept Development and Evaluation Program were used to provide another perspective on the land and water resources required; macroeconomic results followed from the scenario development activity. The institutional analysis, completed before development of the scenarios, focussed on regulatory issues.

Scenario data are shown in Table 1. Table entries are the number installed megawatts for each technology for the year 2030, for three sets of scenario assumptions UH, UI, and CI (U means unconstrained in terms of the limits on coal production and deployment of nuclear power plants, C means the opposite, H denotes high energy intensity, and I denotes an intermediate energy intensity), with and without an SPS.

Land requirements were first derived on a normalized basis for each of the energy technologies. In km^2 per 1,000 MW of installed capacity, the land requirements used here are: 10 for coal, 3 for light water reactor (LWR), 2 for liquid metal fast breeder reactor (LMFBR), 20 for terrestrial photovoltaic (TPV), 35 for SPS, and 2 for fusion. These amounts include (where appropriate) land requirements for resource and fuel extraction, processing, the power plant site itself, and waste disposal. Transmission requirements are not included because they have been shown to be about the same for all technologies, particularly in view of studies indicating that 60 SPS rectennas can be sited within 300 miles of a load center. Scenario-driven results, shown in Figure 1 for the 1980 to 2030 time period, indicate that total land use (excluding transmission) increases 0-500% without SPS and 100-900% with SPS while electrical energy demand increases 75-850% by the year 2030. The land required by SPS alone in the year 2030 is 2-6 times the total land in use for electrical generation in the United States today. The availability of additional land for power plant sites has not been determined. The need for large contiguous areas, as for SPS rectennas, is a further complicating factor.

Water use in $\text{m}^3 \times 10^6/\text{GW}/\text{year}$, is 22 for coal, 60 for LWR, 22 for LMFBR, 12 for fusion and negligible for TPV and SPS. Total water requirements for the three scenarios, with and without SPS, are shown in Figure 2. Results indicate that deployment of SPS can save large volumes of water. For Scenario CI, SPS saves an amount equal to 40% of the total used in 1980 for baseload electrical generation by coal and nuclear; for Scenario UH, the saving is 170% of today's total.

Due to large uncertainties in determining the resource/reserve levels for both the United States and the world, the analysis of materials problems was less quantitative than the land and water analysis. A screening methodology focussed on a reliance on imports criteria and included availability and total demand considerations. These screening factors identified gallium as being a material of serious concern. Gallium is used extensively in the GaAlAs solar cell option for SPS. Also, of serious concern is tungsten, which is used both in SPS and coal technologies.

Net energy analysis shows that the payback period for most of the technologies studied is small (less than 1.5 years). The SPS GaAlAs option, coal, and nuclear options are about one year, with the SPS Si option being about 6 and TPV (silicon cells) 20 years. Thus, the GaAlAs design affords SPS with an option that compares favorably with conventional technologies on a net energy basis.

Macroeconomic analyses included the calculation of changes in GNP for the year 2000 and, in qualitative terms, the effect on inflation due to deployment of SPS. Using a target GNP of 3.7 trillion dollars (all figures in 1978 dollars) for the year 2000, deployment of 10 GW of SPS power will require 20 to 50 billion dollars of excess investment compared to the least expensive (coal) option. This is 10 to 25% of 200 billion dollars, the amount available for financing economic growth of about 2.3% per annum. Compounded to the year 2030, such a reduction would result in a \$200 to \$500 billion reduction in the target GNP of \$7 trillion.

If uranium and coal fuel supplies are much more constrained than presently envisioned, then deployment of SPS would reduce consumption of these scarce items and possibly reduce their prices. This could in turn reduce total energy expenditures, as indicated in Table 2. For the UH and UI scenarios, SPS energy costs of about 40-50 mills/kWh would result in a breakeven from a total energy expenditures point of view.

The institutional analysis focussed on the regulatory aspects of electricity generation by coal, nuclear, and SPS. The technologies were characterized relative to each other. Justifications for regulation, the level of governmental responsibility, and the cost of regulation were considered. Studies estimate that the annual cost of regulating the nuclear industry is about \$6 billion, versus about \$3.4 billion for coal. In view of the changing regulatory environment (e.g., the decentralization movement and the growth of power on a local scale), it is possible that SPS regulatory costs may look more like nuclear regulatory costs than coal regulatory costs, due in part to the international regulatory aspects of SPS. If this is true, regulatory costs for SPS could be significant compared to SPS investment costs, particularly in a low deployment rate (3.3 GW/yr) scenario.

Conclusions may be stated in the form of important tradeoffs identified in the comparative assessment. In the resources area, the water requirements of coal and nuclear technologies are balanced by the land requirements of solar technologies; materials and net energy issues appear to be of secondary importance, and not significantly different between technologies. Macroeconomic tradeoffs involve the use of scarce (or supply-constrained due to regulations) fuels by coal and nuclear technologies (which tends to be inflationary) versus deployment of capital-intensive SPS technology (which siphons off investment funds earmarked for economic growth, resulting in reduced GNP unless there are offsetting factors) which utilizes direct solar energy. Finally in the institutional area, choices involve the known and anticipated regulations of coal and nuclear technologies versus the unknown regulations for SPS (which has an international regulatory dimension).

Table 1
 Baseload Electricity Demands for 2030 in Gigawatts
 (With and Without SPS)

<u>Scenario</u>	<u>Coal</u>	<u>LWR</u>	<u>LMFBR</u>	<u>TPV</u>	<u>SPS</u>	<u>Fusion</u>
UH	580	630	370	70	X	110
UI	110	180	190	50	X	60
CI	30	100	170	40	X	50
UH	460	530	310	70	300	90
UI	70	170	130	50	150	20
CI	20	70	120	40	100	40

Table 2
 MACROECONOMIC ANALYSIS SHOWS THAT
 SPS MAY EFFECT A NET DECREASE
 IN ANNUAL ENERGY EXPENDITURES
 (Expressed in Billions of 1978 \$)

Scenario:	<u>UH</u>		<u>UI</u>		<u>CI</u>		<u>CI(d)</u>	
	<u>60</u>	<u>120</u>	<u>60</u>	<u>120</u>	<u>60</u>	<u>120</u>	<u>60</u>	<u>120</u>
Mills/kWh:								
2015	8	79	4	34	-12	11	-3	20
2025	14	132	6	56	-20	19	-5	34
2030	16	158	8	67	-25	23	-6	41

Fig. 1. The Land Required by SPS in 2030 is 2-6 times the Total in Use for Baseload Electrical Generation Today.

Square Kilometers (in Thousands)

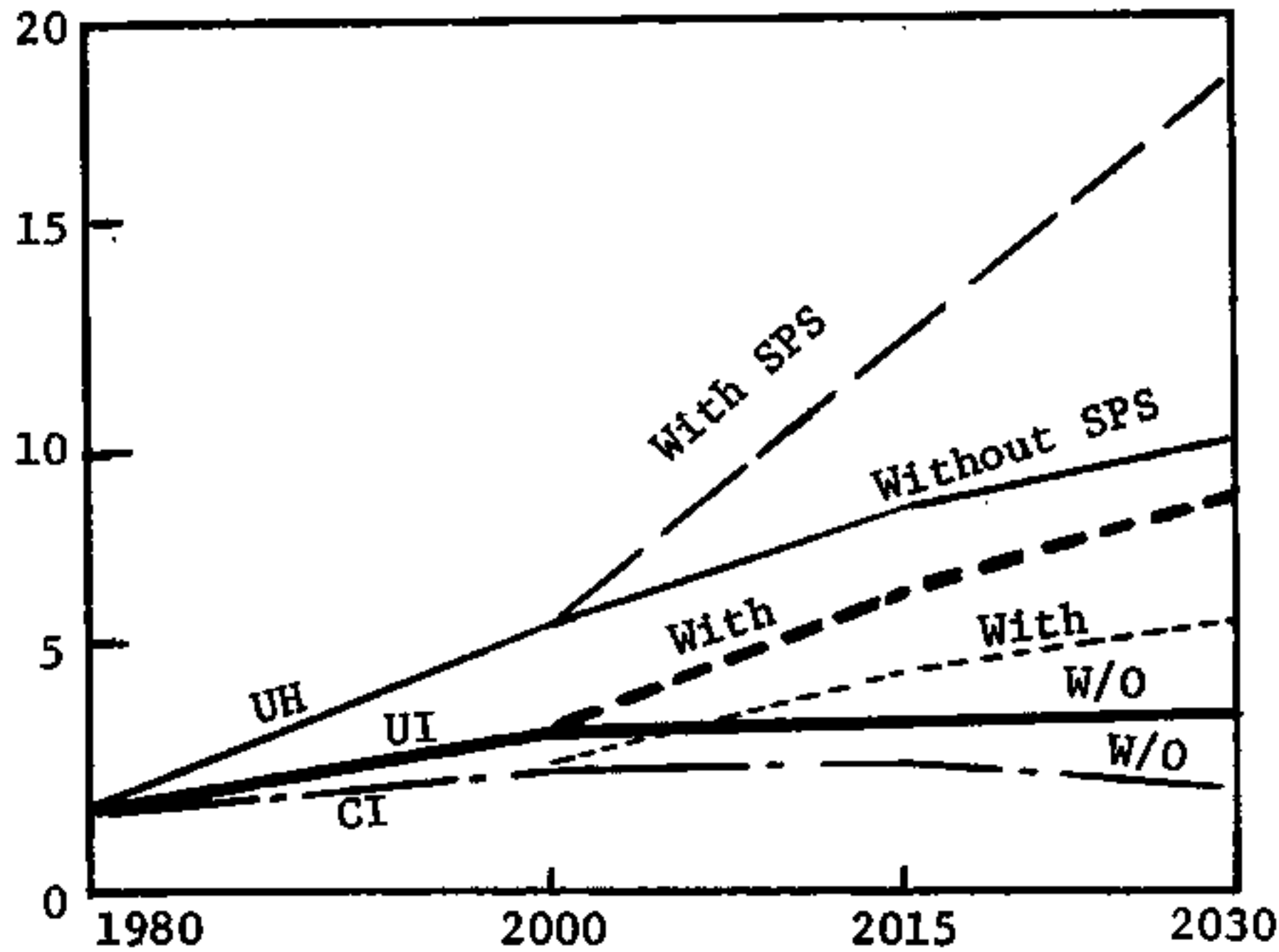
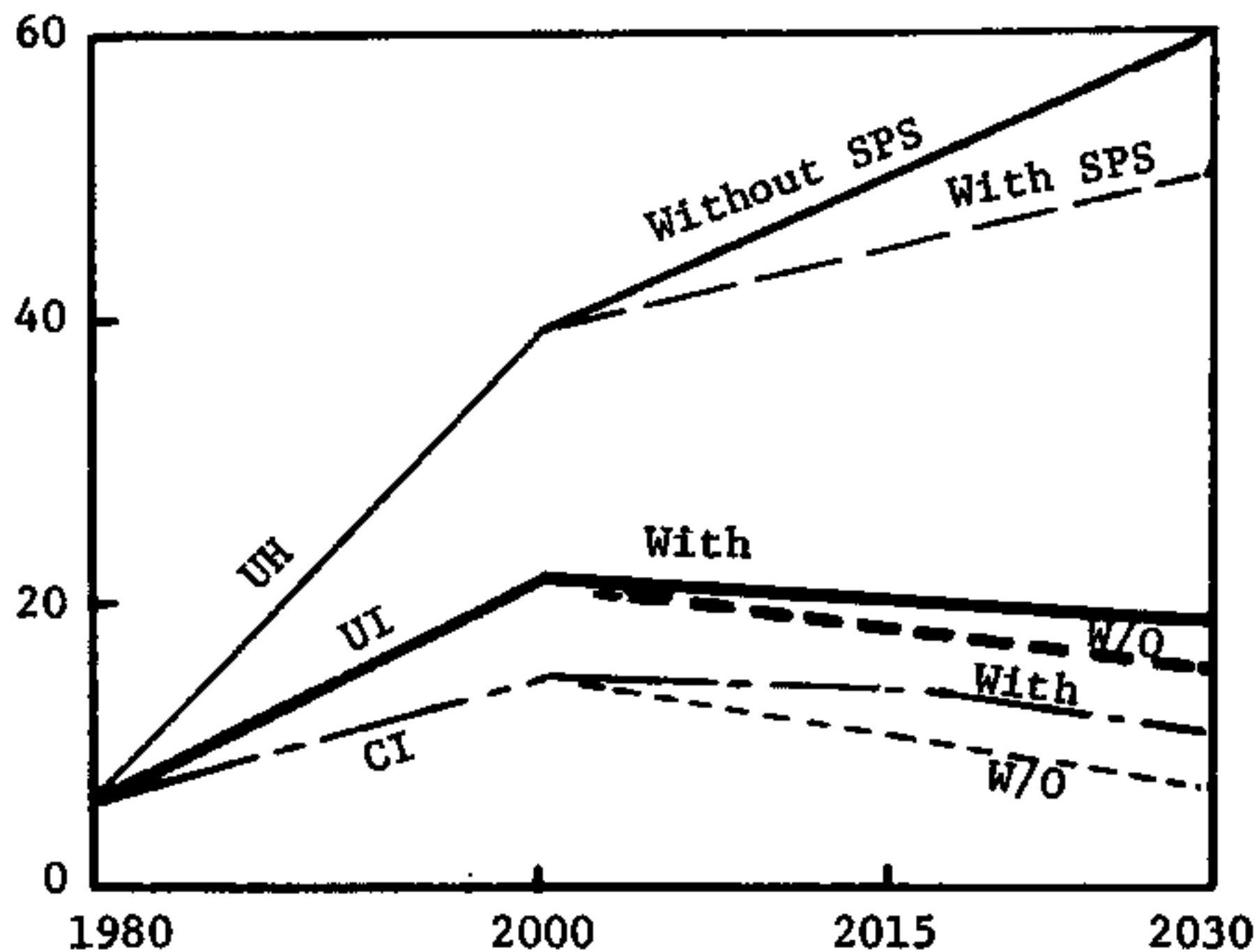

Fig. 2. Deployment of SPS Can Save Large Volumes of Scarce Water Resources.

Billions of m³



SUMMARY: SPS PROGRAM REVIEW
Friday, 25 April 1980

Frederick A. Koomanoff
U. S. Department of Energy

The basic inference or "bottom-line" of these four days of the SPS Program Review stated by the four assessment area managers - Systems Definition, Environmental, Societal and Comparative - is that no insurmountable barrier to the SPS concept have emerged. Significant technical, environmental and cost questions, however, have not been answered. There is need for "hard data" which can be obtained only through research and experimentation. The basic and applied research required to develop the knowledge which is mandatory for informed decision-making has been indicated during this review.

Further, we must recognize that there is no single decision-point for a "go or no-go" decision on demonstrating a SPS. Intelligent decisions based upon unambiguous information and specification of risks must be made at many time phases: research, engineering, verification, proof of concepts, etc.

The SPS program has created and produced very positive generic research results. Every dollar spent has given us increased knowledge as to SPS and has significantly increased our knowledge of basic areas of interest such as:

- microwave health and ecology;
- atmospheric sciences;
- large space structures and space transportation;
- materials;
- energy plant siting;
- also, learning of ways to increase the depth and breadth of participation in the decision process.

This "corporate assessment" of a new, promising technology has attempted to involve many diverse groups to enhance communications, interaction and dialogue.

As C. P. Snow (in Two Cultures) states -- "The only weapon we have to oppose the bad effects of technology is technology itself. There is no other. We can't retreat into a non-technological Eden which never existed. . . . It is only by the rational use of technology -- to control and guide what technology is doing -- that we can keep any hopes of a social life more desirable than our own: or in fact of a social life which is not appalling to imagine."

We must learn how to effectively talk and listen to each other, and arrive at positions based upon the best knowledge available so that informed decisions as to the SPS concept may be made.

SPS STRUCTURES AND CONTROL: A PERSPECTIVE

Robert C. Ried

NASA/JSC, Houston, Texas 77058

Current concepts for a Solar Power Satellite (SPS) are inherently large systems. In the relatively benign external load environment of space; however, the characteristics and design requirements for the structure and control systems are quite different from a terrestrial system. To provide a perspective on these systems, and to provide some background for the more comprehensive papers which follow, a rather simplistic but indicative analysis on a representative configuration has been developed. It should be emphasized that this approach addresses a particular concept only as a mechanism for providing insight.

The first figure illustrates the representative configuration masses and dimensions in convenient approximate magnitudes. The largest magnitude external influences are illustrated in the second figure. There are, of course, many smaller external disturbances which must be considered in the design of a real system as well as control forces, forces between conductors, inertial and gravity loading and the most significant internal loading, isometric stress for stiffness. The lightest weight structure can be achieved through the use of the most efficient structural elements (axially loaded members). A cable or membrane represents the most efficient structural elements, however these elements are limited to tension. To take compression, a column or truss must be designed to be stable from buckling. For lightly loaded and long columns, the most efficient approach is to build a tier of smaller efficient elements as illustrated in Figure 3. Note that as the structure is tiered the mass characteristics approach a proportionality to material density and load and an inverse proportionality to Young's Modulus (E). In general, the structural mass can be reduced by configurations which use fewer but larger compression members. A significant point is that in spite of the large scale of SPS structures, the lightly loaded columns can be designed by minimum gauge material considerations.

The prime design consideration for the SPS structure and control systems is dynamic stability. The classical approach for achieving a dynamically stable system is to employ a frequency separation as illustrated by the frequency hierarchy in Figure 4. The greatest magnitude disturbance is the gravity gradient torque which cycles only twice a day. A simple attitude control law approach, as illustrated in Figure 5, gives a control correction frequency which is proportional to the square root of the disturbance torque derived by the allowable angular momentum impulse deadband. The system dynamic frequencies, as governed by the structural stiffness and overall system mass, are dependent primarily on geometry as illustrated in Figure 6. The largest component of this SPS mass is the solar cell blankets which, to first order, behave as membranes with a frequency dependence as illustrated in Figure 6.

Classical frequency separation is possible for the isolated major system components of the example configuration as illustrated in Figure 7. If the array and the antenna were isolated for this example configuration, the structure control interaction would be minimal. Since these components are connected by the rotary joint, the dynamics and control characterization requires a more in-depth analysis. The significance of structure control interaction and the significance of stiffness to the minimization of dynamic energy is illustrated in Figure 8 by the dimensionless plot of energy against time for a step function input to a simple beam. There do not appear to be any insoluble problems associated with the dynamics and control of an SPS but it is an area requiring more in-depth

analysis and experiments.

The thermal environment for an SPS is dominated by solar radiation and waste heat rejection by the antenna, in the example configuration. Thermal distortion can significantly reduce the buckling stability for a compression column as illustrated in Figure 9. This can be avoided by structural configuration design, appropriate thermal control, use of a low coefficient of thermal expansion (CTE) material or a combination of these. The daily solar cycle of the antenna could also lead to unacceptable thermal distortion if similar techniques were not employed. The significant parameters to the distortion of an antenna is illustrated in Figure 10. An in-depth assessment of the achievable flatness for the reference system antenna was studied by General Dynamics, Convair. As given in Figure 11, the results of this study indicate that the desired flatness of 2 arc minutes could be achieved by state-of-the-art manufacturing tolerance, within maneuvering distortions and within thermal distortion if a low CTE material is used. An existing graphite/epoxy (GY-70/X-30 pseudoisotropic) was used to provide a realistic assessment of material properties and variations in properties. The transient thermal environment associated with biannual occultations can induce dynamic distortions of the overall system depending on the detailed thermal response characteristics and configuration. The dynamic response of the example configuration can be held to a minimum if the structural material is a low CTE material.

The prime findings of the SPS studies to date in the areas of structures and controls are listed in Figure 12. Although the SPS has a significant need for engineering and development work by analysis and experiment in the structures, controls and materials areas, there do not appear to be any insurmountable problems in these areas. There is a definite need for technology development in these areas, however. An in-depth assessment of the control system design and associated system performance is still needed. The significant interrelationships between control sensors, actuators and structural response are not well understood. The limitations of structural and dynamic modeling and their significance to control and system performance require assessment. First order analysis indicate that a 7% scale system (.4% full scale energy) in low earth orbit can provide a reasonable similitude for verification testing of the structure and control systems.

There is also a need to develop an understanding of the long term behavior of materials and coatings in the SPS operating environment. The behavior of materials under the particulate, UV radiation and plasma exposure with low level stress and thermal cycling needs quantification. The significance of construction and assembly to structural design, material selection and control requirements cannot be underemphasized. Overall, the SPS system is an intriguing challenge to the control, structures and materials specialists.

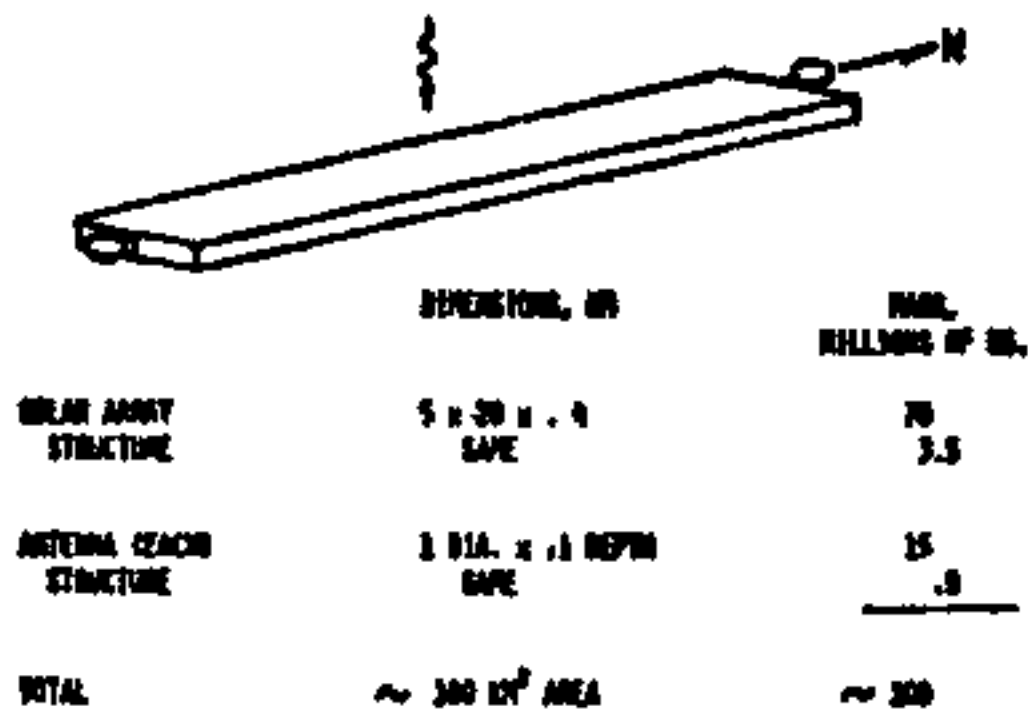

FIGURE 1 - EXAMPLE OF CONFIGURATION

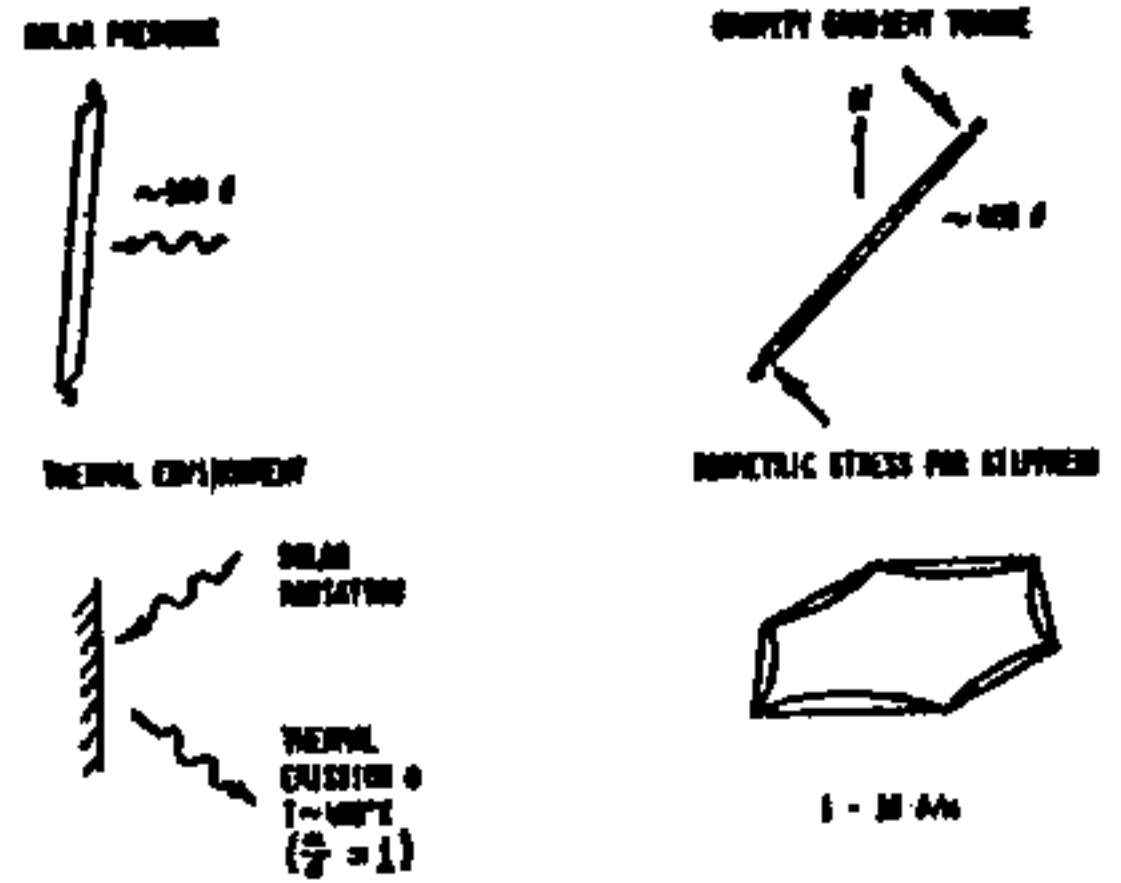

FIGURE 2 - LOADS AND ENVIRONMENT

	CRITICAL BUCKLING LOAD	CRITICAL LOAD
CYLINDRICAL ELEMENT	$\sim \rho [L_c] \left[\frac{P}{E} \right]^2$	$\sim \rho L \left[\frac{1}{D} \frac{P}{E} \right]^2$
TRIANGULAR TRUSS OF CYLINDRICAL ELEMENTS	$\sim \rho \left[L_c \frac{P}{E} \right]^2$	$\sim \rho \left[\frac{1}{D} \right]^2 \left[\frac{PL}{E} \right]^2$

- EFFICIENT SPACE STRUCTURES CAN BE MADE WITH LIGHTLY GAUGED (P), LONG LENGTH (L), INCLUDING LIMITED COLUMN WHICH ARE TIED FROM WALL RANGE (C) BUCKLING LIMITED ELEMENTS
- STRUCTURAL MATERIAL REQUIREMENTS ARE:
 - LOW DENSITY, ρ
 - HIGH YOUNG'S MODULUS, E
 - SMALL GAUGE, t

FIGURE 3 - STRUCTURAL INEQUALITIES CHARACTERISTICS



- ARRAY DISTURBANCE FREQUENCIES & GRAVITY GRADIENT
- GRAVITY GRADIENT FREQUENCY = $2.5 \times 10^{-3} \text{ Hz}$ (1.00 CAD)

FIGURE 4 - FREQUENCY STABILITY FOR CLASSICAL SYSTEM STABILITY

ASSUMPTIONS

- SINGLE DEGREE OF FREEDOM ROTATION @ ABOUT Y AXIS, POP
- RIGID BODY
- CONSTANT DISTURBANCE TORQUE IMBALANCE, M_c
- SQUARE WAVE CONTROL TORQUE, M_c

CONTROL FREQUENCY, $f_c = \left(1 - \frac{M_c}{K} \right) \sqrt{\frac{E I_c}{2 I_{xx} L^2}}$

GRAVITY GRADIENT DISTURBANCE

	ARRAY	ANTENNA
$\Delta \theta$	$\sim 1^\circ$	$\sim 3'$
$\frac{M_c}{2 I_{xx}}$	$\sim \frac{3 \times 10^4}{4}$	$\frac{3 \times 10^4}{10}$
f_c	$\sim 2.5 \times 10^3 \text{ Hz}$	$\sim 1.5 \times 10^3 \text{ Hz}$

FIGURE 5 - CONTROL FREQUENCIES OF FREQUENCY APPROACH

ARRAY $f_c \sim \left(\frac{M_c}{2 I_{xx}} \right) \left(\frac{E I_c}{L^2} \right)^{1/2} \left(\frac{E I_c}{2 I_{xx} L^2} \right)^{1/2} \left(\frac{E I_c}{2 I_{xx} L^2} \right)^{1/2}$

ANTENNA $f_c \sim \left(\frac{M_c}{2 I_{xx}} \right) \left(\frac{E I_c}{L^2} \right)^{1/2} \left(\frac{E I_c}{2 I_{xx} L^2} \right)^{1/2} \left(\frac{E I_c}{2 I_{xx} L^2} \right)^{1/2}$

SOLAR BLANKETS OVERHEAD $f_c \sim \left(\frac{M_c}{2 I_{xx}} \right) \left(\frac{E I_c}{L^2} \right)^{1/2} \left(\frac{E I_c}{2 I_{xx} L^2} \right)^{1/2}$

FOR EXAMPLE CONFIGURATION

ARRAY	ANTENNA	BLANKETS
$\sim 2.5 \times 10^3 \text{ Hz}$	$\sim 1.5 \times 10^3 \text{ Hz}$	$\sim 10^3 \text{ Hz}$

FIGURE 6 - SYSTEM (STRUCTURAL) FREQUENCIES

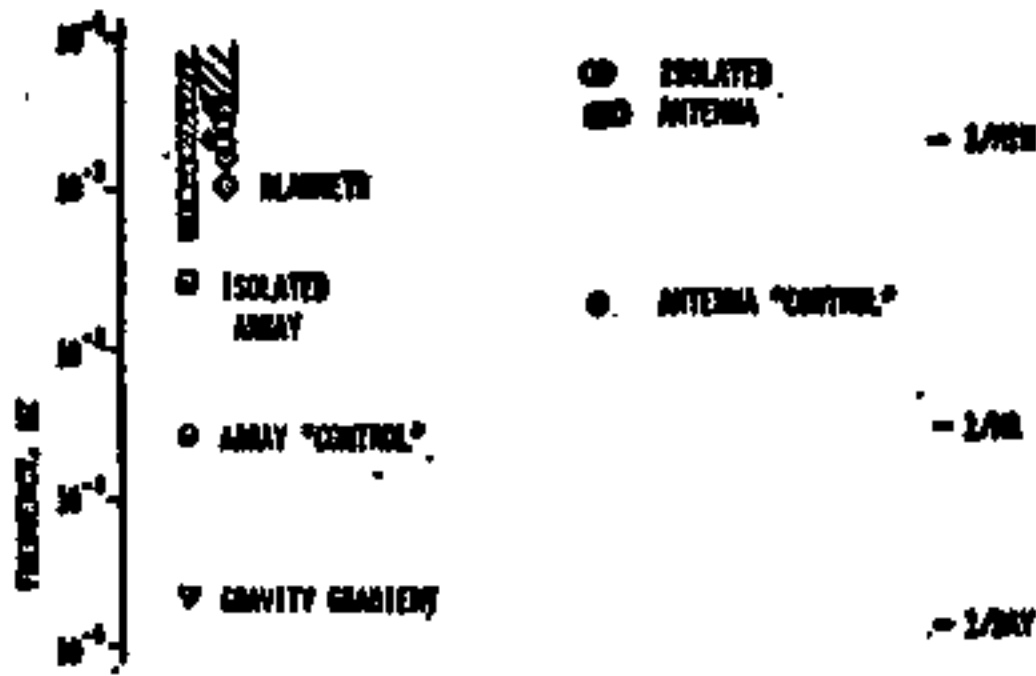

FIGURE 7 - "FREQUENCY" FOR EXAMPLE SPS SYSTEM.

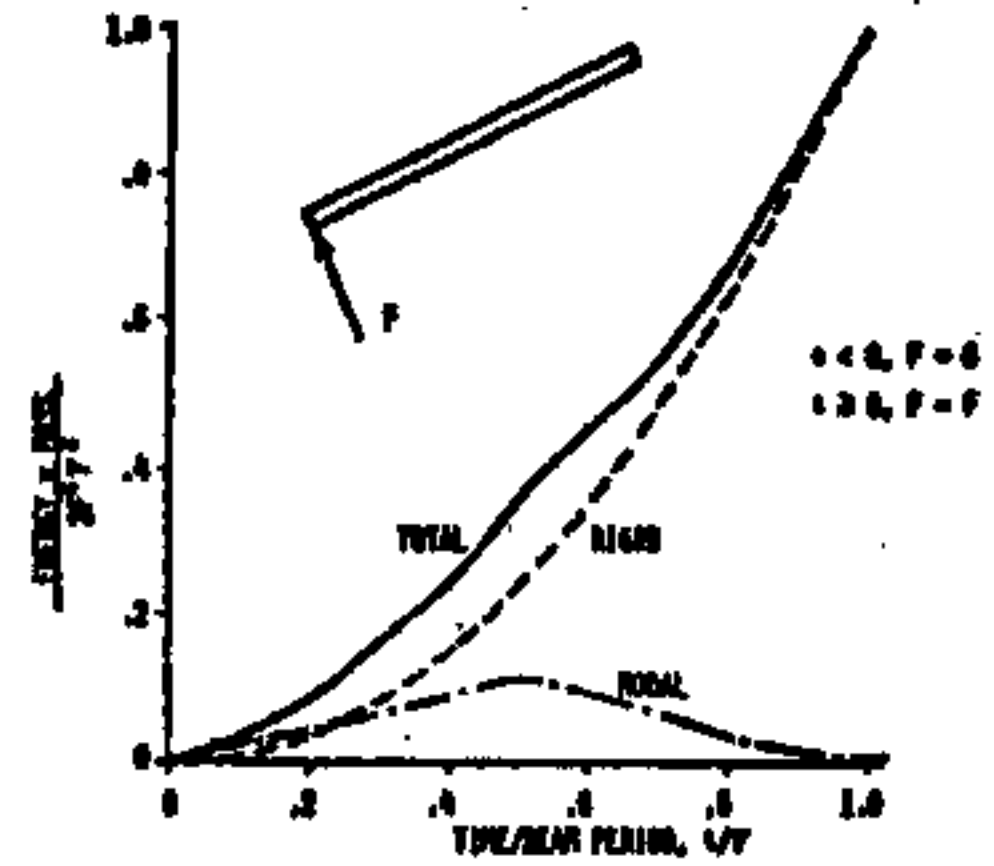

FIGURE 8 - ENERGY IN A BEAM FROM STEP FUNCTION FORCE

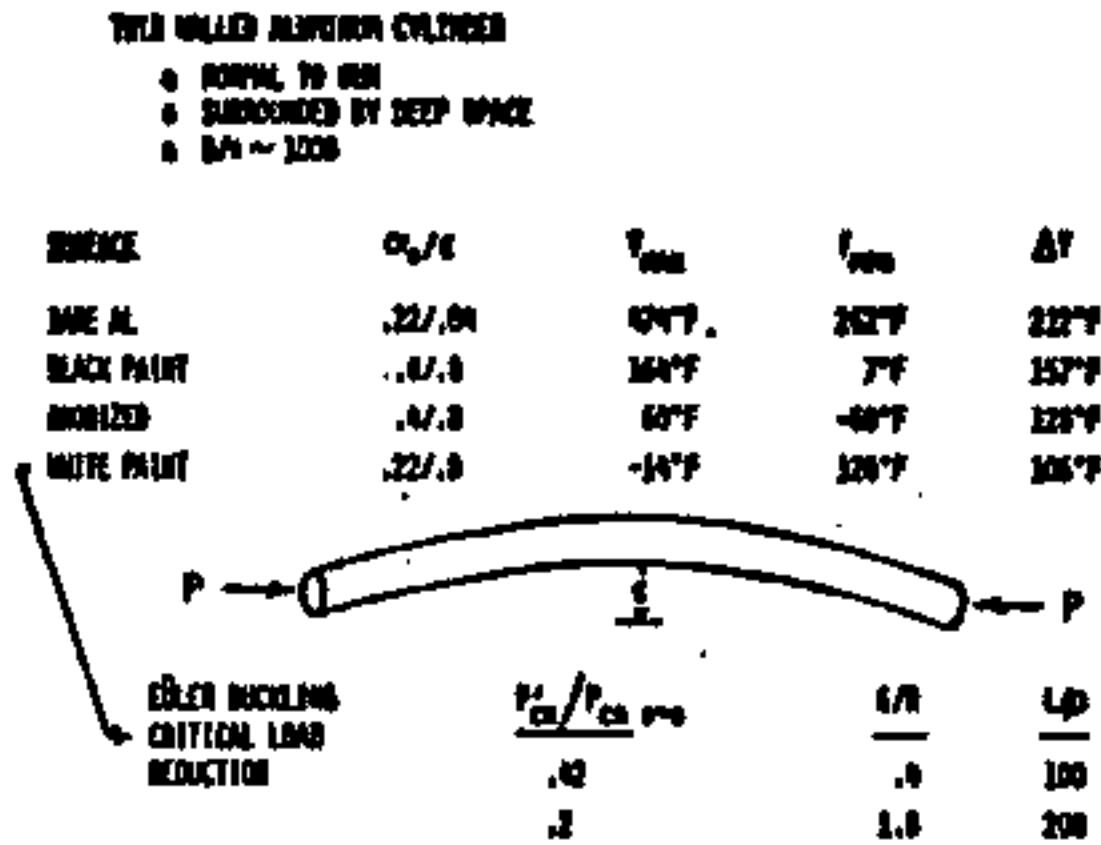

FIGURE 9 - SOLAR RADIATION INFLUENCE ON COLUMN STABILITY

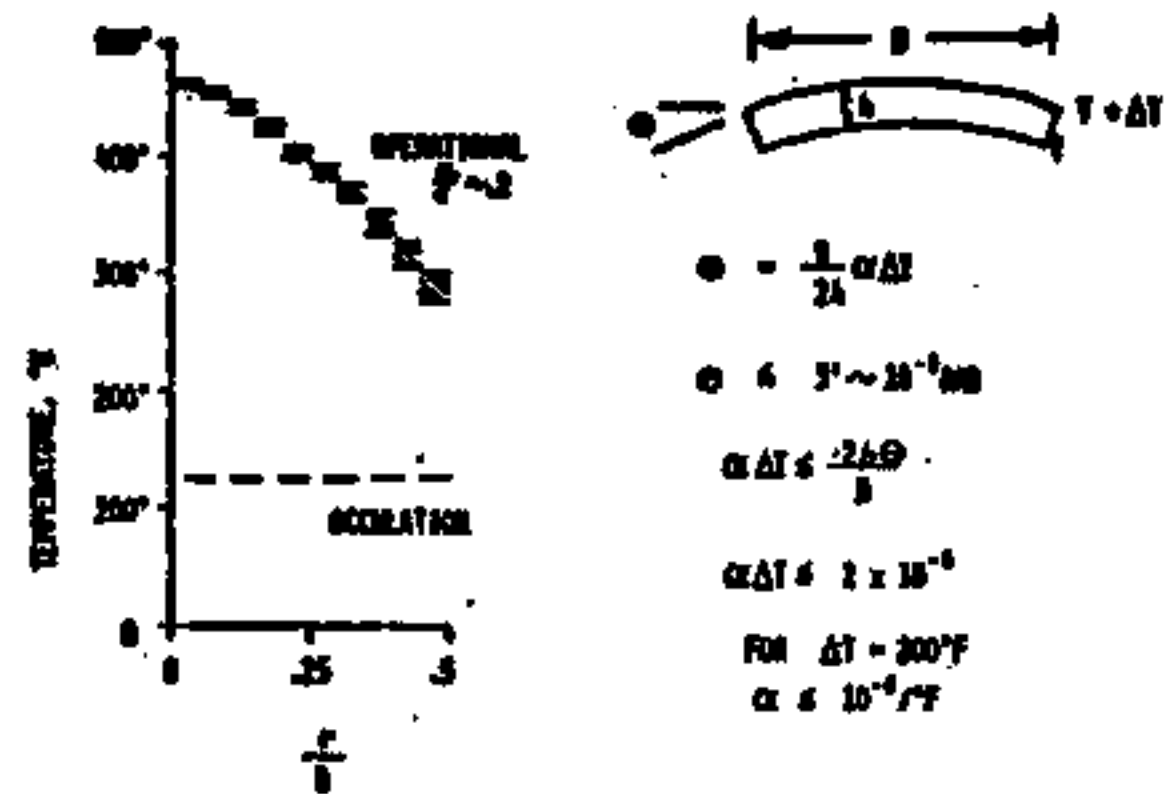

FIGURE 10 - EXAMPLE ANTENNA THERMAL ENVIRONMENT

- MANUFACTURING TOLERANCES CAN BE MET WITH STATE-OF-THE-ART TOLERANCE AND ASSEMBLY TOLERANCES
- ACTUAL SLOPE ERRORS ARE INSIGNIFICANT EXCEPT FOR POSSIBLE OSCILLATIONS AFTER OSCILLATION
- THERMAL DISTORTIONS ARE SMALL FOR STATE-OF-THE-ART GRAPHITE MATERIAL PROPERTIES

	SLOPE ACCURACY ARC MIN.	PERCENT LOSS
MANUFACTURING TOLERANCE	1.5	.5
MANEUVERING ACCELERATIONS	1.1	.3
THERMAL DISTORTIONS	.7	.2

FIGURE 11 - REFERENCE ANTENNA ACHIEVABLE FLATNESS ASSESSMENT (GENERAL DYNAMICS, COMNAV CONTRACT NOS 9-15403)

- BEYOND LOAD ENVIRONMENT
- STRUCTURAL MASS FRACTION LOW (≈ 200)
- STRUCTURE & CONTROL SYSTEMS ARE INTIMATELY COUPLED IN PROVIDING DYNAMIC STABILITY
- PRIME STRUCTURAL DESIGN REQUIREMENT IS STIFFNESS
- FRESHMAN PHYSICS CALCULATIONS INDICATE FREQUENCY SEPARATION POSSIBLE FOR ISOLATED MAJOR COMPONENTS
- VERIFIABLE VERIFICATION OF STRUCTURE & CONTROL NOT POSSIBLE - UNPRECEDENTED RELIANCE ON NUMERICAL SIMULATION
- THERMAL DISTORTION CAN BE SIGNIFICANT UNLESS LOW CTE MATERIAL USED OR APPROPRIATE DESIGN STRATEGY EMPLOYED
- ANTENNA FLATNESS APPEARS TO BE ACHIEVABLE
- CONSTRUCTION AND ASSEMBLY ARE MAJOR CONSIDERATIONS TO STRUCTURE, CONTROL AND MATERIALS
- TECHNOLOGY DEVELOPMENT NEEDED IN:
 - CONTROLS
 - MATERIALS
 - STRUCTURES

FIGURE 12 - SPS SATELLITE STRUCTURE/CONTROL OBSERVATIONS

SPS ATTITUDE CONTROL AND STATIONKEEPING – REQUIREMENTS AND TRADEOFFS

R.E. Oglevie

Rockwell International, Downey, California

This paper summarizes the results of attitude control and stationkeeping (AC&SK) studies^{1,2,3} to define spacecraft and mission requirements, preferred control approaches, and feasibility issues.⁴ The work was partially accomplished under NASA MSFC Contract NAS8-32475.

Three orbits with features attractive to SPS are shown in Figure 1. The ecliptic orbit permits direct solar viewing in a horizontal attitude, which minimizes gravity gradient disturbance torques. The 7.3° inclined orbit minimizes the north-south stationkeeping ΔV requirement. The geosynchronous equatorial orbit is preferred because of the large cost of the increased rectenna size associated with the two other orbits.

The large size of the SPS makes appreciable changes in AC&SK requirements relative to small contemporary spacecraft. Analyses^{2,3} indicate that the solar pressure stationkeeping perturbation becomes dominant rather than the solar-lunar gravitational perturbation. Gravity gradient disturbance torques increase rapidly as a function of spacecraft size and can cause appreciable attitude control penalties without judicious choice of spacecraft reference orientation and spacecraft design parameters. Structural bending frequencies are appreciably reduced, raising concern about control system/structural dynamic interaction stability.

The stationkeeping ΔV and RCS propellant requirements are presented in Table 1; correction of the solar pressure perturbation dominates the requirements. If uncorrected, the solar pressure perturbation will cause a $\pm 2.5^\circ$ cyclical change in longitude with a one-year period. This is unacceptable in light of the heavy use of the geosynchronous equatorial orbit projected during the SPS time frame. The stationkeeping propulsion requirements necessitate the use of high-performance propulsion (such as ion thrusters) to minimize propellant resupply expense over the SPS lifetime. Flying the SPS spacecraft in clustered constellations offers promise of minimizing their space requirements in geosynchronous orbit.

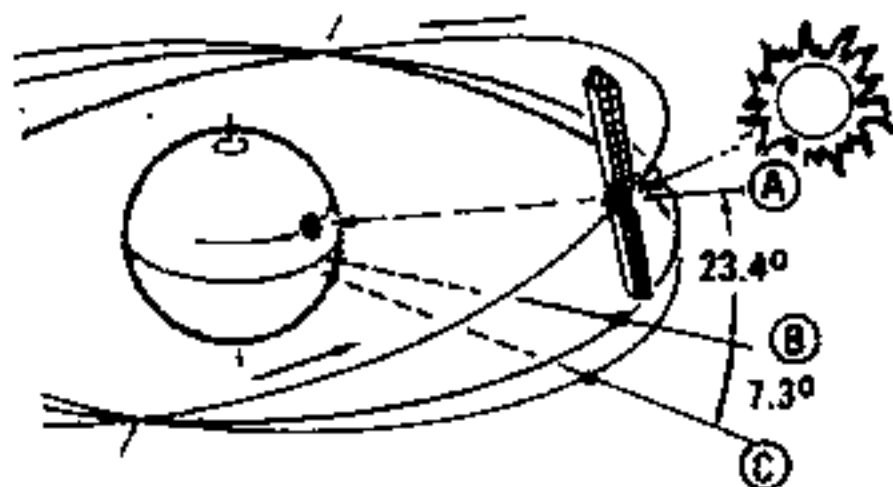

Table 1. Stationkeeping ΔV and Propellant Requirements

GEOSYNC. ORBIT PLANE	INCLINATION (DEG)	RECTENNA SIZE INCREASE*	N-S STATION KEEPING	
			ANNUAL ΔV REQUIRED (M/SEC)	30 YR. RCS PROPELLANT (% S/C MASS)
ECLIPTIC Ⓐ	23.4	88.5%	TBD	TBD
EQUATORIAL Ⓑ	0	0	46 M/SEC	1.25
MIN. N-S STATION-KEEPING ΔV Ⓒ	7.3	13.9%	~ 0	~ 0

Orbit Perturbation	ΔV (M/S/Year)	Propellant Required Over 30 Years* (% of Spacecraft Mass)
Solar pressure (E-W)	282.5	6.65
Solar/lunar perturbation (N-S)	53.3	1.25
Earth triaxiality (E-W)	2.1	0.05
MW radiation pressure (E-W)	Negligible	Negligible
Station change maneuvers (E-W)	1.1	0.03
Total	339.0	7.98

* $I_{sp} = 13,000$ sec

* FOR 34° LATITUDE (LOS ANGELES)
** $I_{sp} = 13,000$ SEC

Figure 1. Orbit Selection Trade

¹Satellite Power System Concept Definition Study. Vol. II. Rockwell International, SSD 79-0010-2-1 (March 1979).

²Oglevie, R.E., "Attitude Control of Large Solar Power Satellites," AIAA Paper 78-1266, AIAA Guidance and Control Conference (August 1978).

³Satellite Power System Concept Definition Study. Vol. III. Rockwell International, SD 78-AP-0023-3 (April 1978).

⁴The assistance of D. Camillone of Rockwell in performing this work is gratefully acknowledged.

Microwave beam pointing is achievable with an antenna pointing accuracy of 0.05 deg and electronic beam steering for precise vernier pointing. Solar collector pointing accuracy requirements are a function of collector concentration ratio and are on the order of 0.5° for $CR=2$. These accuracies are achievable with existing technology and current studies indicate they can be met without active figure (structural shape) control. Simple active figure control in the microwave antenna may prove to be useful in simplifying the structural design and assembly tolerances.

Attitude control techniques considered for the SPS include: spin and gravity gradient stabilization, solar pressure vanes, large erectable momentum wheels, quasi-inertial free drift modes, and various reaction control thruster types (Figures 2-4). The spin, gravity gradient, and solar pressure vane stabilized approaches were all found to be inferior to the selected baseline because of their larger mass and complexity penalties. The large erectable momentum wheels (Figure 3) and the quasi-inertial free-drift attitude mode are useful in eliminating propellant consumption due to cyclical disturbance torques. The propellant requirements for various RCS thruster types (Figure 4) indicate that high-performance propulsion (such as argon ion thrusters) is required to avoid the high propellant resupply costs of contemporary chemical propulsion systems for a 30-year spacecraft lifetime.

The attractiveness of RCS thrusters for attitude control is enhanced by combining attitude control and stationkeeping requirements, and satisfying them jointly with the same propulsion systems.¹ The approach is illustrated in Figure 5. Thruster groupings are at each corner of the spacecraft and nominally thrust continuously toward the sun to correct solar pressure orbit perturbations. Other stationkeeping perturbations are considerably smaller and are corrected by gimbaling the thrusters through small angles. Similarly, the attitude control torques are obtained by a combination of differential throttling and gimbaling. The system is capable of simultaneously providing stationkeeping forces and attitude control torques about all three axes. Since the required gimbal angles are small, these functions are satisfied with a propellant quantity that is only slightly greater than that required to correct the solar pressure stationkeeping perturbation. Gimballed thrusters are preferable to body-fixed thrusters because of a significant reduction in the number of thrusters and propellant required. During earth eclipse periods only attitude control torques are provided. This control approach minimizes the system requirements for attitude control and is selected for the baseline reference configuration (Figure 5). Nominally 36 thrusters are required; however, 64 are provided to accommodate for failures and servicing. The mass of the overall AC&SK

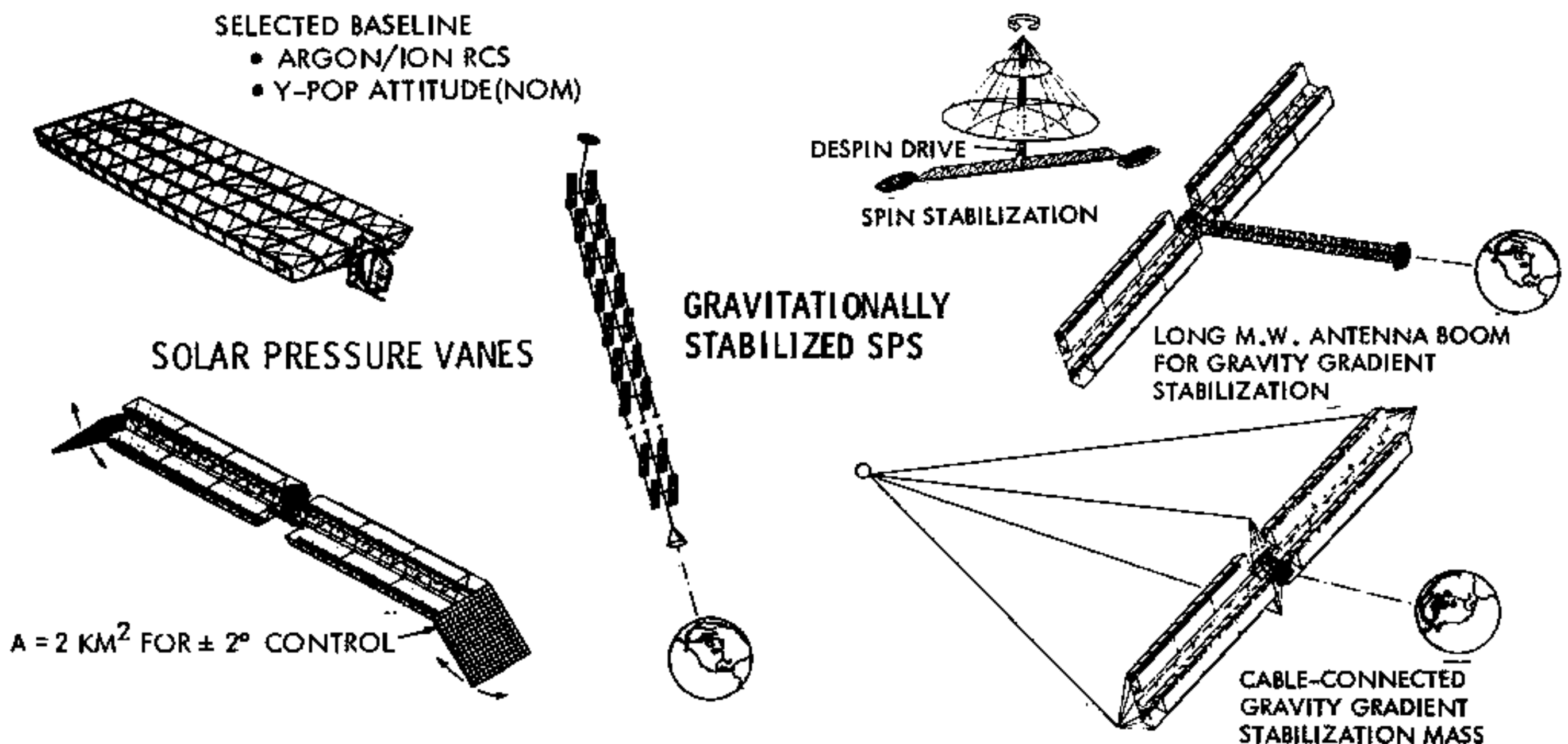

Figure 2. Attitude Control Concepts

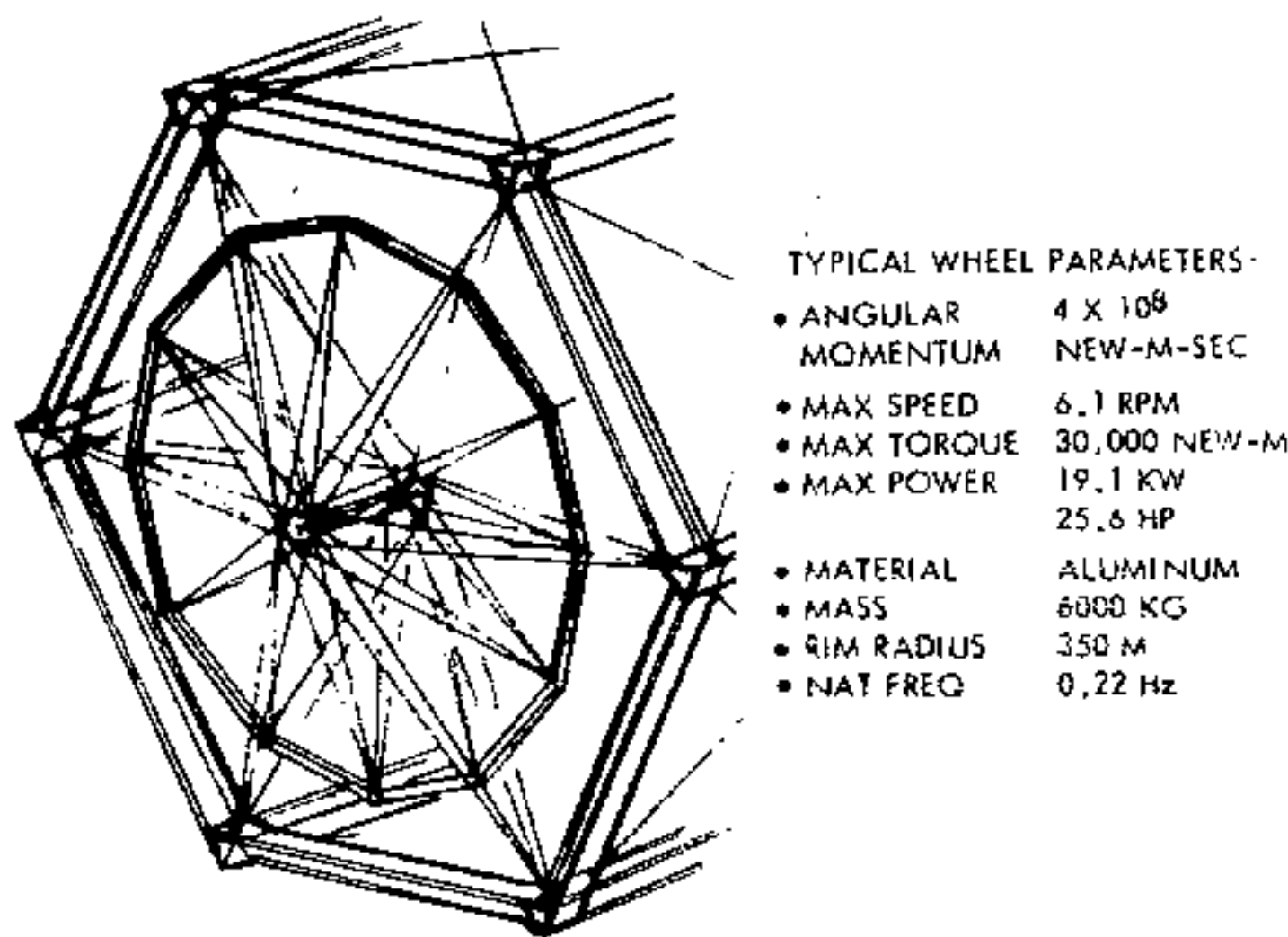

Figure 3. Erectable Momentum Wheel Conceptual Design

- ATTITUDE CONTROL & STATIONKEEPING PROPELLANT
- REFERENCE CONFIGURATION
- CONTINUOUS SOLAR PRESSURE STATIONKEEPING CORRECTION IS DOMINANT REQUIREMENT

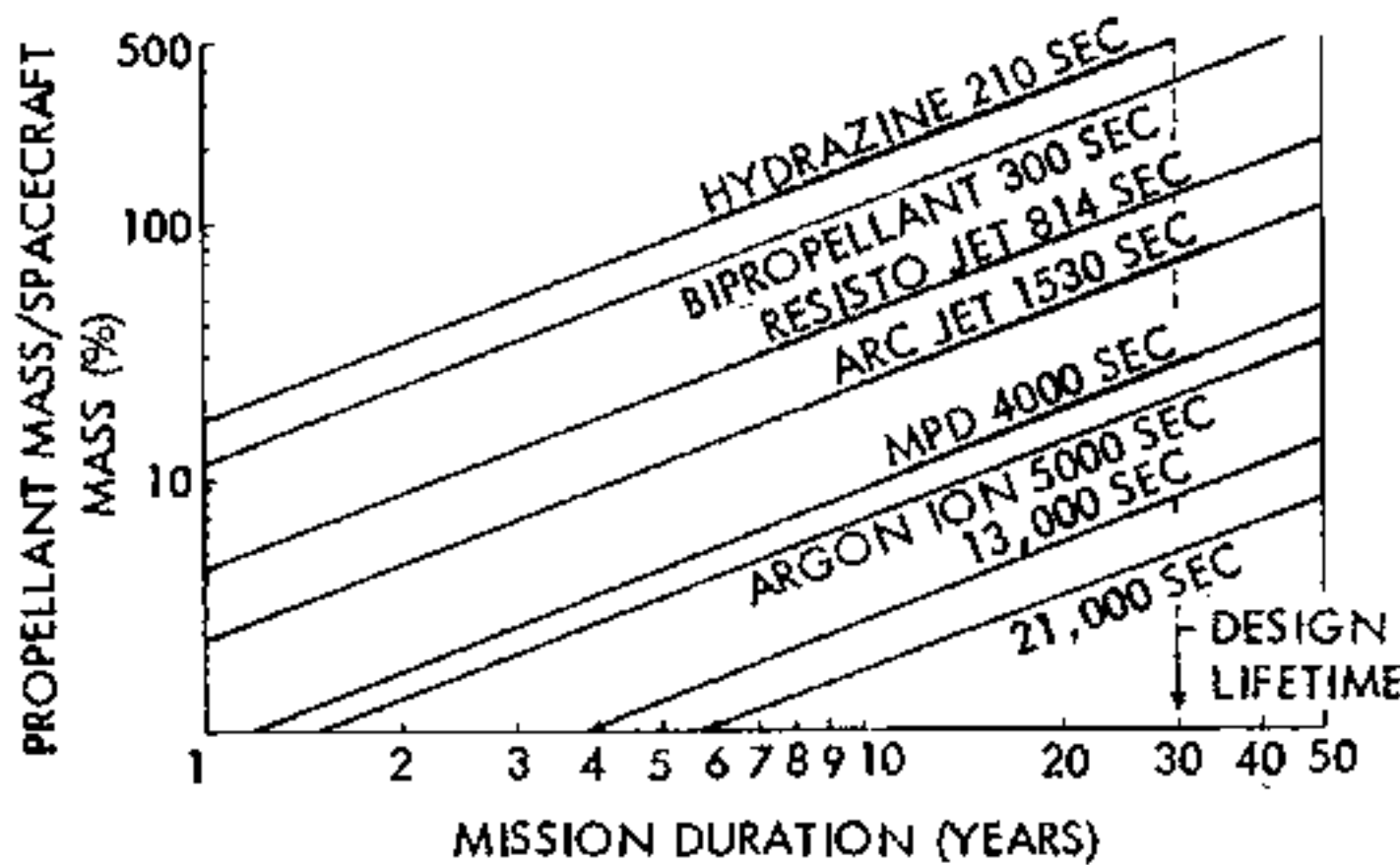

Figure 4. Propellant Requirements for Various RCS Propulsion Types

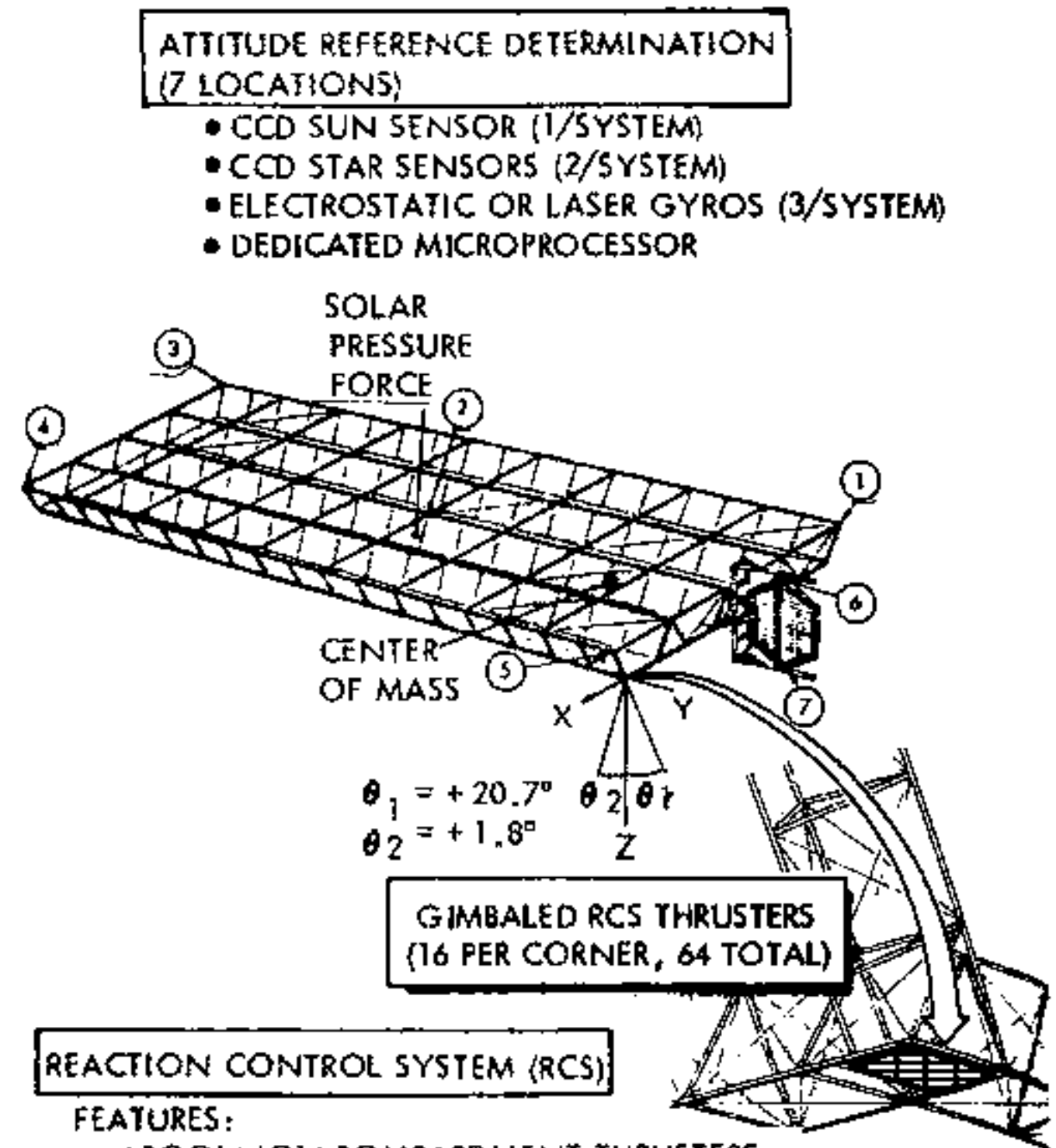

Figure 5. Baseline Attitude Control and Stationkeeping System

system is given in Table 2 and is 0.08% of the spacecraft mass (dry) and 0.37% with annual propellant requirement. The average operating power is 34 megawatts.

Dynamic stability is a concern because of low SPS structural frequencies in the order of 6 cycles/hour. Preliminary simplified analyses have been performed³ to establish control bandwidth requirements and system stability. Quasi-linear control torques are obtained with a combination of throttling and on-off thruster commands. The results indicate that substantial separation between control bandwidth and structural frequencies exists (Figure 6) and that stability is achievable using classical control techniques. This is due primarily to the low SPS bandwidth requirements for the sun-staring application. Small increases in depth of the structure can appreciably increase structural frequencies with only minor increases in structural mass. However, technology advancement in control of large space structures is recommended to support potential structural mass savings and spacecraft design simplifications.

A variety of SPS configurations have evolved, with significantly different AC&SK requirements. The solid-state SPS configuration depicted in Figure 7 has a larger solar pressure stationkeeping propellant requirement than the reference spacecraft due to larger area/mass and area/power ratios.

Table 2. AC&SK System Mass Summary

Item	Mass (x 10 ⁺³ kg)
Attitude reference determination systems (7)	0.32
Thrusters – including support structure (64 at 120 kg/thruster)	7.68
Tanks, lines, refrigeration	15.07
Power processing equipment	TBD
Argon propellant – annual requirement	85.39
Total (dry)	23.07
Total (With Propellant)	108.46

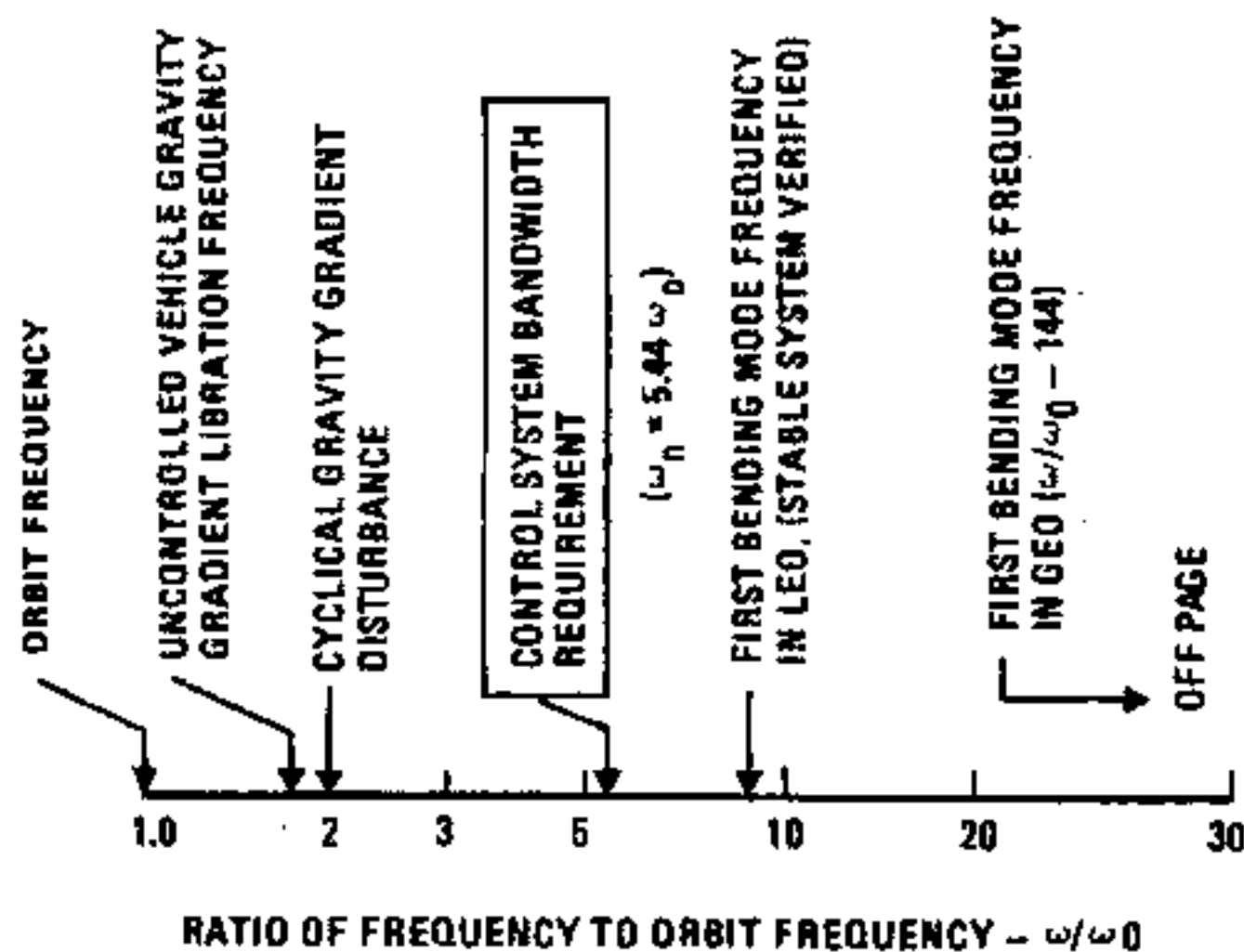
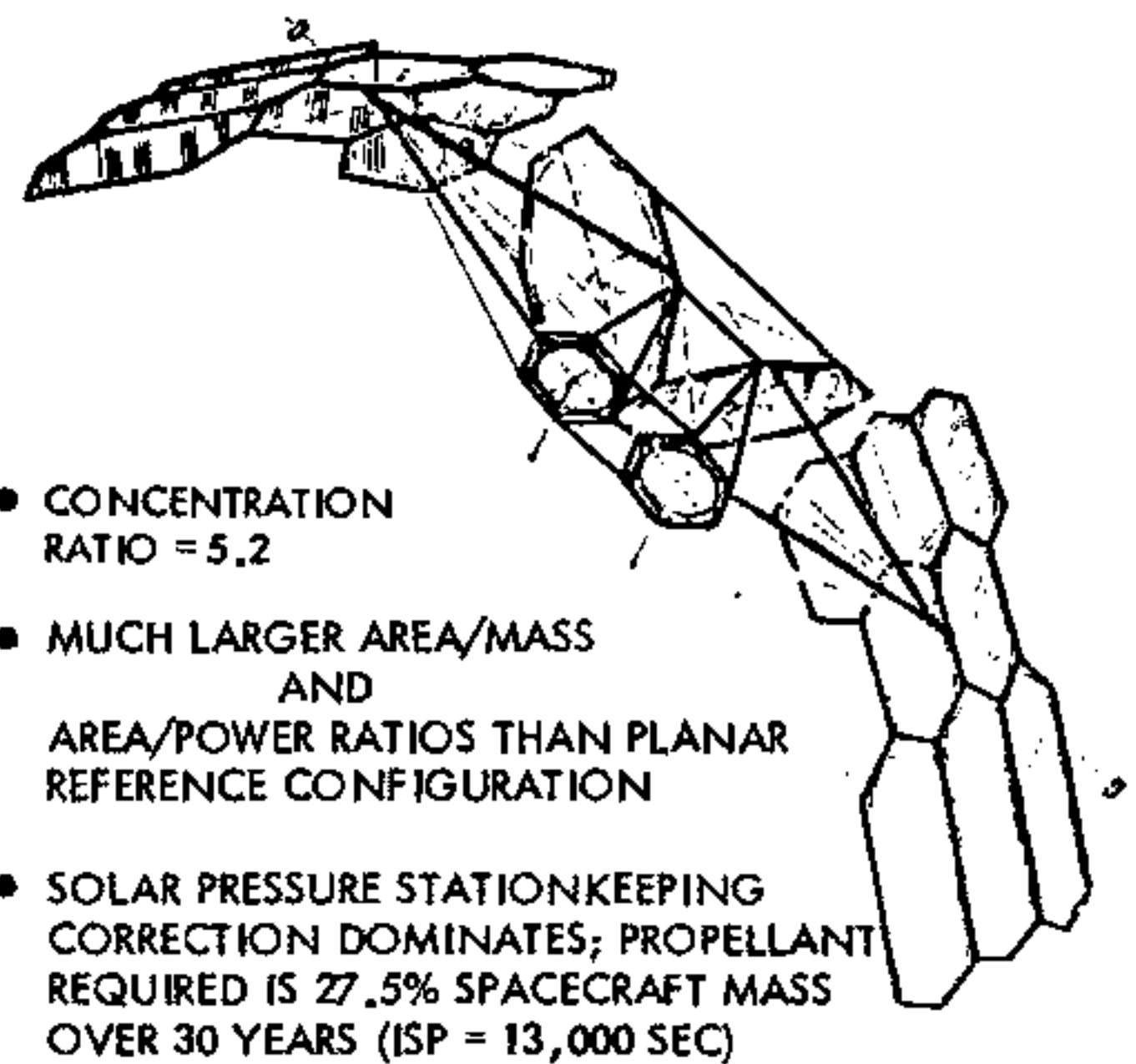

Figure 6. Frequency Distribution

The symmetrical “dual” configuration is preferable to an unsymmetrical “single” energy conversion system spacecraft because of the large propellant requirements (41.1% of spacecraft mass over 30 years) due to additional large gravity gradient and solar pressure torques which arise from the asymmetry.

In summary, the dominant control requirements of SPS change appreciably relative to small contemporary spacecraft. The trade studies and analyses have illustrated preferred control approaches and that the AC&SK requirements are tractable. No major feasibility issues are visible at this time. Supporting conclusions include:

1. Geosynchronous equatorial orbit is preferred over the alternative orbits considered.
2. The solar pressure orbit perturbation dominates stationkeeping propulsion requirements. High-performance propulsion is necessary to avoid large propellant resupply costs.
3. A combined AC&SK system using ion electric propulsion can satisfy the attitude control requirements with very small propellant increases over that required to correct solar pressure orbit perturbation.
4. Gravity gradient and solar pressure disturbance torques can cause large attitude control propellant penalties for asymmetric configurations.
5. Control system/structural dynamic interaction stability can be obtained through frequency separation with reasonable structural requirements. Modern controllers can potentially ease structural dynamic requirements and simplify spacecraft design.



- CONCENTRATION RATIO = 5.2
- MUCH LARGER AREA/MASS AND AREA/POWER RATIOS THAN PLANAR REFERENCE CONFIGURATION
- SOLAR PRESSURE STATIONKEEPING CORRECTION DOMINATES; PROPELLANT REQUIRED IS 27.5% SPACECRAFT MASS OVER 30 YEARS (ISP = 13,000 SEC)

Figure 7. AC&SK Dual Solid-State Configuration

SATELLITE POWER SYSTEMS STRUCTURES—A 1980 TECHNOLOGY STATUS REVIEW

by H. Stanley Greenberg

Rockwell International, Space Operations and Satellite Systems Division

In 1976, the Department of Energy and NASA initiated a broad concept evaluation program to develop, by 1980, an initial understanding of the economic practicality and socio/environmental acceptability of the Satellite Power System (SPS) program. An essential component of the program is the system definition studies, within which are the structure technology investigations. This paper reviews the current SPS structure technology status.

System definition studies for JSC (Boeing) and MSFC (Rockwell) are being focused on the class of configurations shown in Figure 1. The two configurations at the left capture sunlight on ultra-large arrays of either silicon or gallium arsenide solar cells and transmit the generated electrical energy through conductor runs and rotary joint to the microwave power transmission system (MPTS) composed of either solid-state power amplifiers or klystron tube devices. The solid-state configuration at the right delivers sunlight through primary and secondary reflectors (CR=5) to solar cells that are structurally integral with the solid-state amplifiers and, hence, eliminate electrical conductors and power transfer across a rotary joint.

The classes of major structural components and constructions utilized by these configurations are delineated in Table 1 along with designation of the general status of the technology. The overall technology is essentially at the preliminary design stage, with the exception of the machine-made beam developments. On May 4, 1978, a ground demonstration machine, developed by Grumman for MSFC, fabricated a 1-m-deep aluminum, triangular-shaped truss-type beam. A structural test of the beam verified its strength suitability. Graphite composite triangular and geodetic beams are being developed by General Dynamics and McDonnell Douglas for JSC, with the present progress as shown.

These structural components, in conjunction with the control system, must satisfy the regime of system dimensional stability requirements shown in Figure 2 during exposure to the varying environments shown. The most stringent of these requirements are those pertaining to the MPTS antenna. The curvature requirement translates into maintenance of flatness to essentially 0.5 m across a diameter of 1700 m. Satisfaction of such requirements with these ultra-large structures would be unthinkable if not for the benign external loading environment shown. For example, the entire solar pressure and gravity gradient load on a 1700-m-diameter aperture antenna is less than the design load on 13 cm² of the orbiter crew module (142 N). The most significant challenge, however, is presented by the combination of thermal environment and 30-year life requirements.

The major issues pertinent to SPS structures are:

- Choice of most cost-effective construction (truss configuration, machine-made beam, beam-to-beam joining)
- Choice of construction material
- In-depth definition of structural design requirements
- Knowledge of state of stress and dimensional integrity of as-built structure
- Predictability of strength and dynamic behavior
- Feasibility of passive figure control approach to MPTS flatness
- Feasibility of structure stiffness compatible with MPTS pointing
- Feasibility of passive control through damping
- Feasibility of space fabrication of ultra-large reflector surfaces
- Qualification, model verification, inspection

The construction in space rather than in the constant gravitational temperature-controlled environment of present ground airframe fabrication, presents questions. At best, with fixed solar orientation during the construction flow, thermal environment changes significant to the as-built state of stress and dimensional integrity can occur. Also, since size and strength preclude extensive ground testing, qualification can only be accomplished with extensive analysis employing detailed finite element models, verified by small component and scale model tests. In-space inspection during fabrication and potential repair capability is of vital concern. In the orbiter crew module all welds are inspected using dye penetrants and X rays. The current policy of inspection of the welded joints in

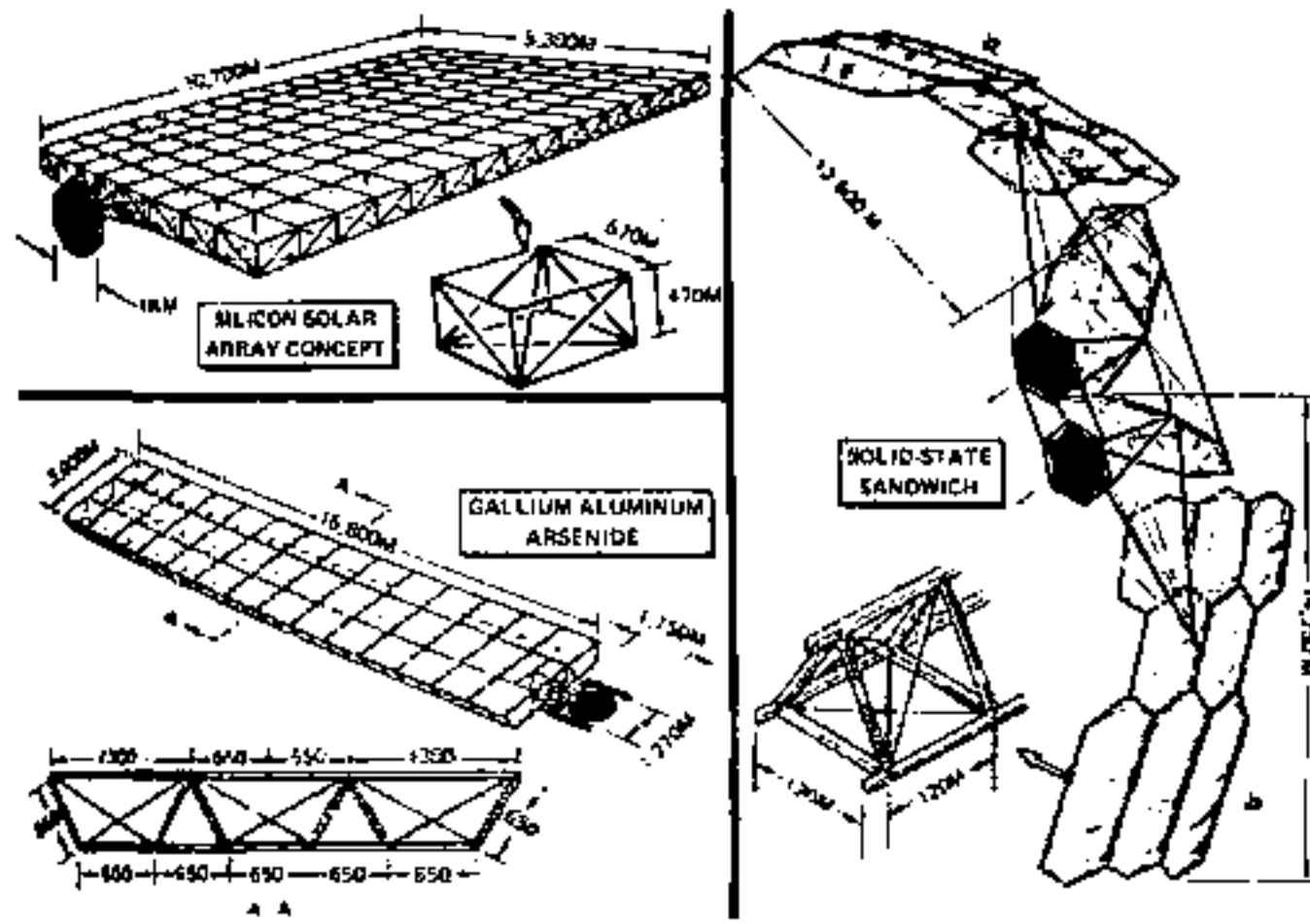

Figure 1. SPS Current Configurations

* SATISFY REGIME OF FIGURE CONTROL REQUIREMENTS

STRUCTURE/CONTROL SYSTEM REQUIREMENT (DEGREES)					
PERFORMANCE PARAMETER	MPTS	PRIMARY REFLECTOR		SECONDARY REFLECTOR	SOLAR BLANKETS
		CR = 2	CR = 5	CR = 5	
POINTING	.05	.1 TO 2.5	.3 TO .5	.1 TO .5	10
SURFACE CURVATURE	.05	.5 TO 7	.2 TO .5	.5 TO 1	2 TO 5

* DURING EXPOSURE TO:

ANTENNA
SHADED BY
REFLECTOR

- * SOLAR PRESSURE - 8 TO 30 X 10⁻⁶ N/M²
- * GRAVITY GRADIENTS - 0 TO 35 X 10⁻⁶ N/M²
- * CONTROL FORCES -- COMPATIBLE WITH ABOVE
- * THERMAL GRADIENTS 0° TO 100°C

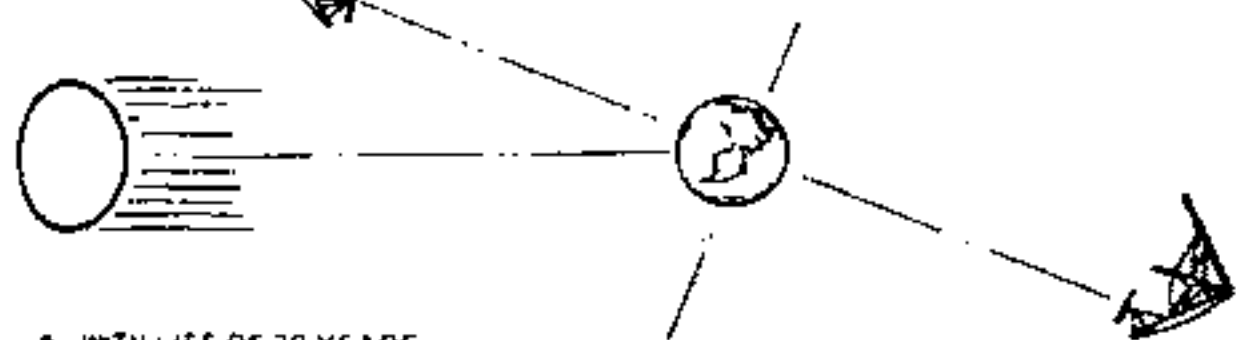

* WITH LIFE OF 30 YEARS

Figure 2. SPS Requirements/Environments

Table 1. Major Structural Components/Status

Class and Components	Status*				
	1	2	3	4	5
Tension-Stabilized Surfaces					
Solar reflector surfaces	X				
Solar cell blankets	X		X		
Tension cable/surface attachment	X		X		
Tension devices	X	X	X	X	
Rigid Surfaces					
Klystron assemblies	X				
Solid-state sandwich	X				
Primary Structure Frameworks					
Platforms	X				
Polygonal compression frames	X				
Trusses of built-up tri-beams	X				
Tri-beams	X				
Machine-Made Beams					
Open cap, aluminum, triangular	X	X	X	X	X
Open cap, composite, triangular	X	X	X		
Closed cap, composite, triangular	X				
Composite geodetic	X	X	X	X	
Beam-to-Beam Joints					
Lap joint	X				
Concentric joint - fixed	X				
Concentric joint - pinned	X		X		
'X' - Bracing					
Tension cable and attach	X				
*Status Areas:					
1-Preliminary concept	4-Structure tested				
2-Mature concept	5-Demonstration article				
3-Article fabricated					

machine-made beams ranges from near total reliance on machine capability to monitoring of critical parameters. Beam-to-beam joint design inspectability and repairability remain to be studied.

At Rockwell, visibility on several of these issues has been achieved through the results of structural analyses in support of system studies of solid-state configurations. Structural analyses were performed to assess the structural feasibility of a hexagonal compression frame/tension cable array primary structure for the MPTS antenna. The orthotropic tension cable array provides support for the solid-state sandwich panels without obstruction of either the solar cell or microwave surface. Figure 3 illustrates the peak eclipse-induced thermal loads relative to the initial closed force cable pretension/frame compression loading. These loads are due to the thermal gradient between the tension cables and frame machine-made beam caps. Both elements are of graphite composite material ($\alpha = 0.36 \times 10^{-6}$ m/m °C). The peak thermal loads are 1 to 3%. With aluminum, the percentage changes would be 20 to 40%. Figure 4 illustrates the two principal thermal sources causing hexagonal frame deflection and deviation from surface flatness. These sources are thermal gradients across the tri-beam structure due to shadowing by the sandwich panel array and temperature differentials between the discrete groups of X-bracing, denoted by solid and dashed lines. The peak thermal deflections of point H are shown parametrically for the antenna apertures shown and for tri-beams designed to the surface restrictions shown as the abscissa. It is noteworthy that the 12-cm deflection

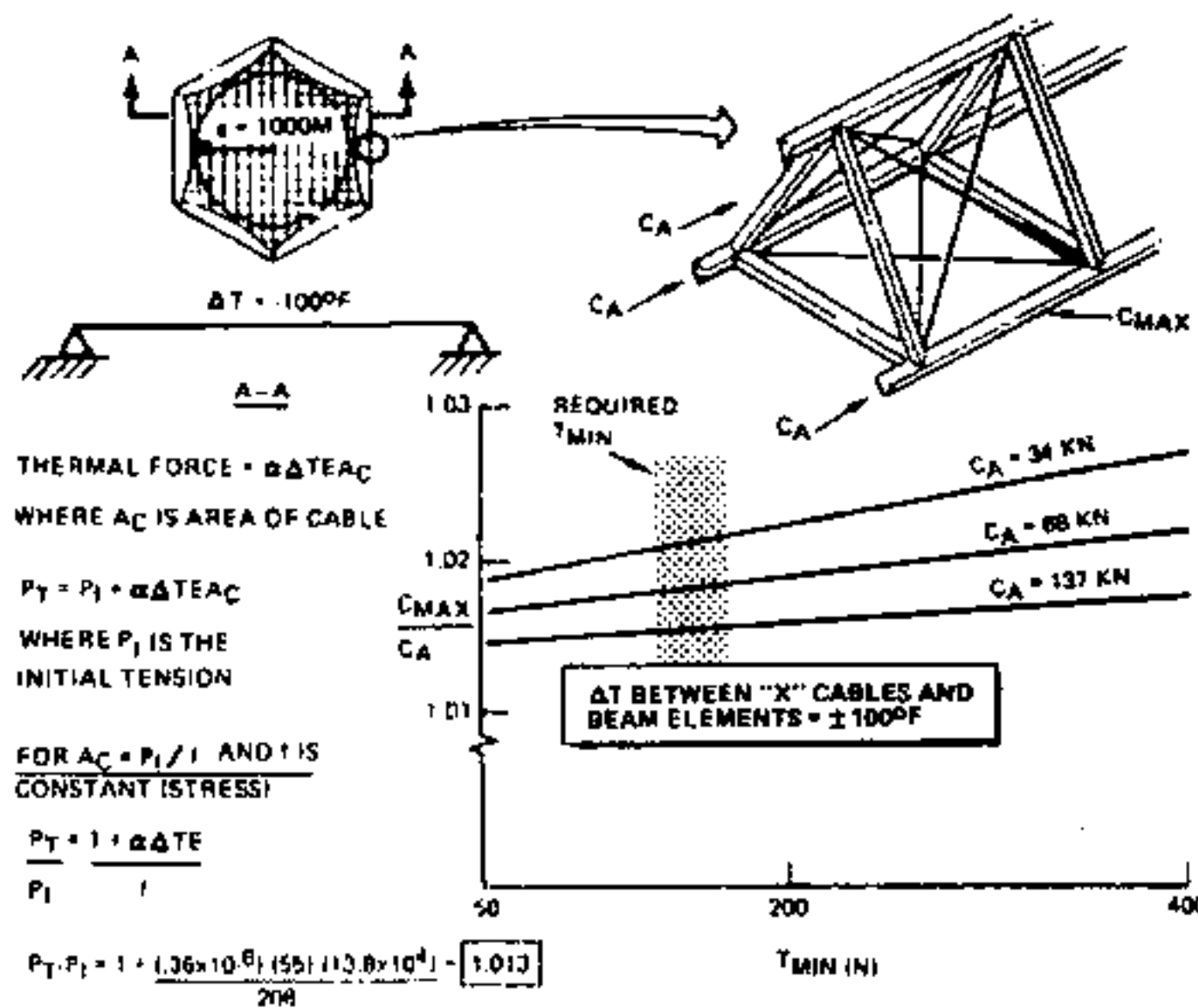

Figure 3. Thermal Load Implications

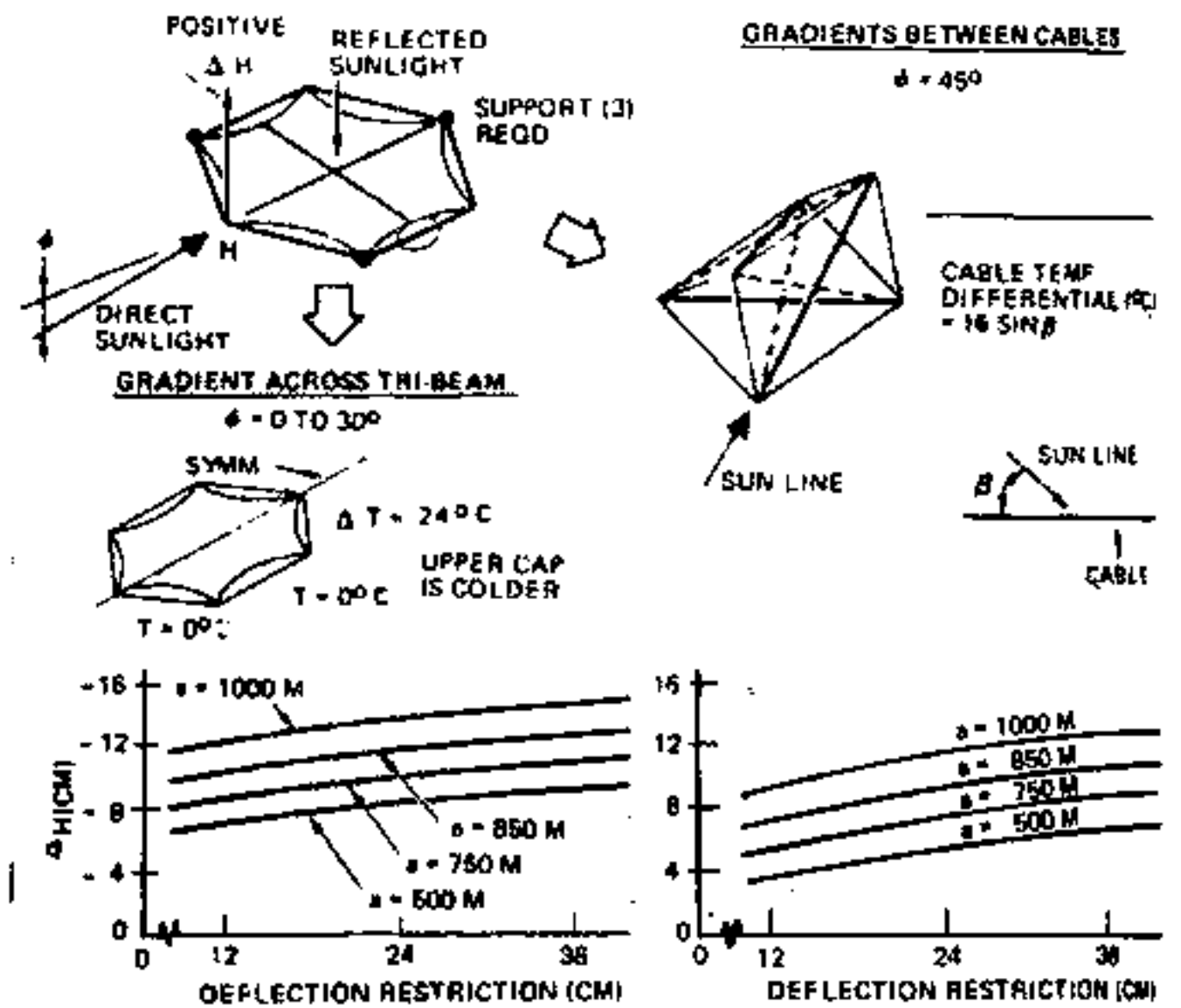

Figure 4. Frame Thermal Deflections

would be 8 m with an aluminum design of the same depth and with a coating of comparable a/ϵ . This data, in conjunction with an optimized frame compression load stability analysis, resulted in the data presented in Figure 5. To maintain a surface flatness to within 18 cm without active figure control, an antenna of 850-m aperture radius will utilize a graphite composite tri-beam 70 m deep and have a total structure mass of 95,000 kg.

The issue of selection of the primary structures material has received considerable attention since 1976. Graphite composite issues (compared to aluminum) pertinent to the hexagonal frame for the MPTS are:

1. Advantages—flatness maintained to required value of 18 cm without active control; eclipse thermal loads negligible (3 to 5%) without constant load devices; minimum weight; minimal thermal load variations during construction (simplification).
2. Disadvantages—higher reduced material unit cost; material suitability risk.

The last advantage pertains to the markedly reduced construction built-in loads. It is recognized that these loads can be essentially eliminated in an aluminum structure that is statically determinate and therefore presents a viable design for a non-critical figure control structure such as a solar blanket support frame. The implications of static determinacy are: (1) no thermally-induced axial loads; (2) no preload (potential elimination of member length adjustments); (3) increased design confidence with reduced analysis effort; (4) reduced number of members to fabricate, handle, place, and attach; (5) weight, depending on loading regime; (6) simplification of qualification testing; (7) loss of redundancy (not expected to be significant); (8) construction fixtures required to accommodate temporarily unrigidized structural assemblies; and (9) not necessarily compatible with automated construction.

The latter two items constitute prime disadvantages that have apparently deterred its use. Also, while a 100% statically determinate structure is not achievable with stable union designs, the achievable degree of determinacy is expected to be sufficient to realize the listed advantages.

The results of modal analysis performed upon the MPTS hexagonal frame and overall solid state configuration are shown in Figure 6. The overall configuration minimum modal frequency of 0.00196 Hz permits the use of classical control techniques. Also shown is the significant separation between the frequency of the configuration and that of the geosynchronous orbit solar-imposed gradient so that essentially no magnification of solar-induced deflections occur in the absence of any damping. The affect of frequency separation with gravity gradient disturbances is comparable.

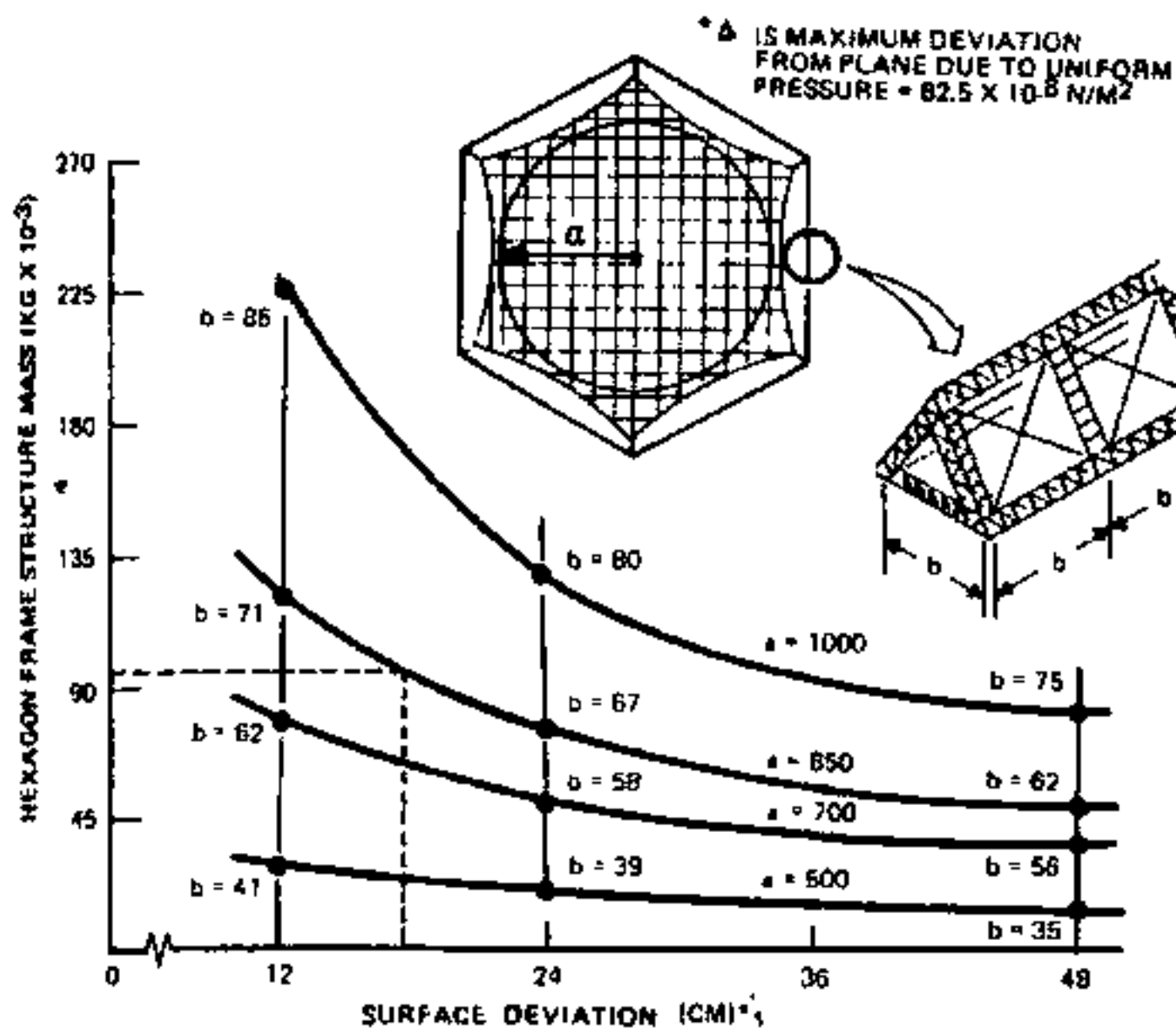

Figure 5. Hexagon Frame Mass Versus Surface Deviation (cm)

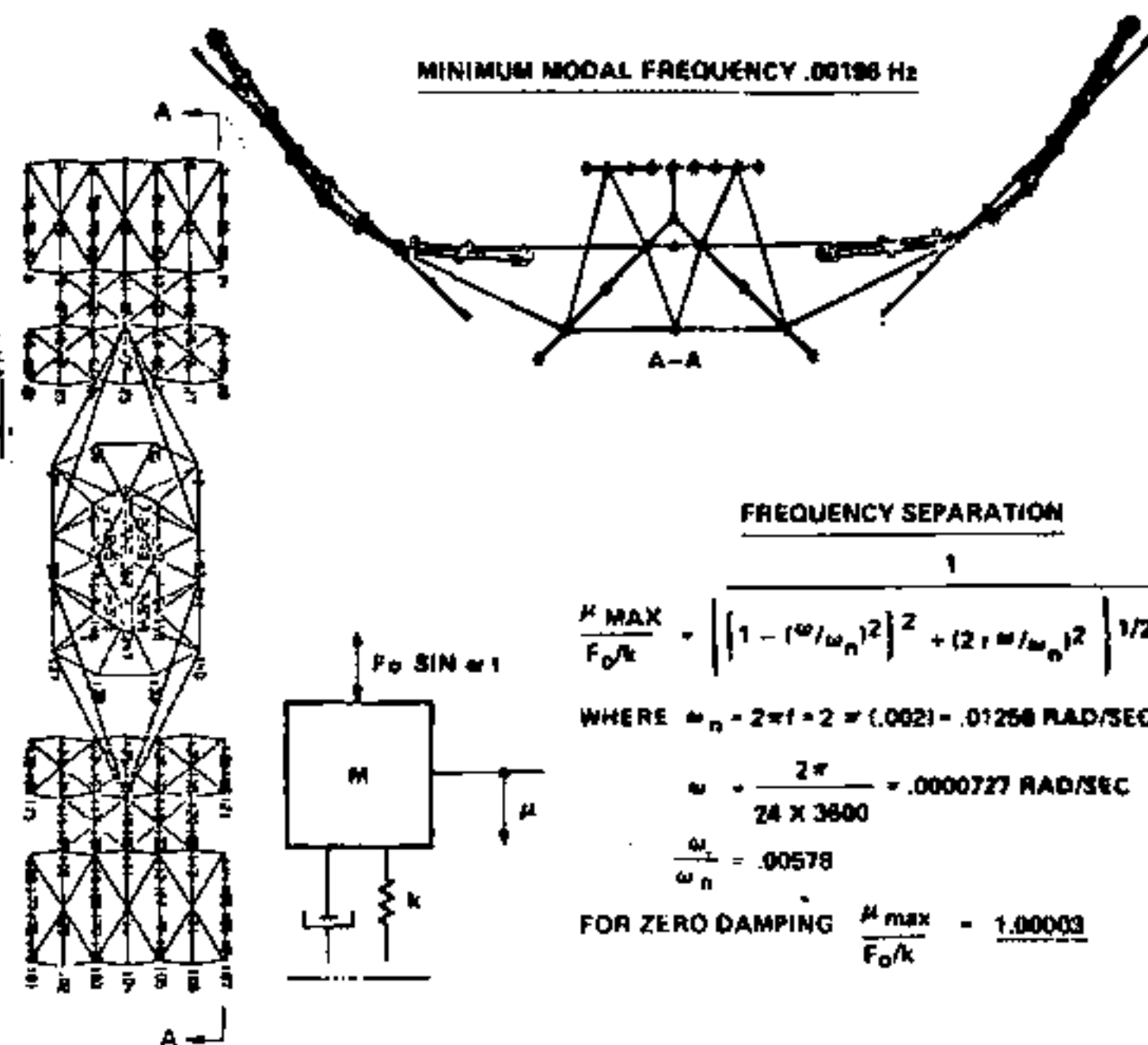

Figure 6. Minimum Modal Frequency Implications

The present 1980 view pertaining to the major issues delineated are shown in Table 2. At present the use of graphite composites is favored in view of the superiority of operational performance and minimal construction built-in loads in indeterminate structures. Hopefully, the material suitability issue will be resolved in the next five years. This is not to say aluminum cannot satisfy all the requirements; with design ingenuity, the significant disadvantages may be eliminated. It should be noted that no structures problem capable of placing significant limitations on the SPS is visible now.

The near-term efforts required to strengthen structures technology sufficient to support SPS program definition include: (1) composite material 30-year suitability, (2) system implications of determinate structures, (3) studies to identify structural requirements, (4) parametric studies to identify most promising constructions, (5) machine made composite beam element development, (6) beam to-beam joint development and inspection requirements, (7) reflector surface/cable attachment development, (8) qualification issues, and (9) engineering to support design of proof-of-concept demonstration article.

Of primary concern is the development/space suitability verification of composite materials. Also, the activities listed should be pursued to the level of depth necessary to permit start of engineering for a proof-of-concept demonstration article within this decade.

Table 2. 1980 Status of Issues

Issue	1980 View	Potential Problem
Most cost-effective construction	TBD	
Choice of construction material	Graphite composite	Thermal, 30-yr life
Definition of structural requirements	TBD	
Knowledge of as-built structure	Determinate structure	
Predictability of structural behavior	TBD	
MPTS passive figure control feasibility	Yes	Composite 30-yr life
Structure stiffness compatible with pointing	Yes	
Passive control through damping	Not required	
Feasibility of space fabrication of ultra-large reflectors and blankets	TBD	
Qualification, model verification, inspection	TBD	

DYNAMICS AND CONTROL OF THE SATELLITE POWER SYSTEM
S. J. Wang - J. N. Juang - G. Rodriguez
Jet Propulsion Laboratory
California Institute of Technology - Pasadena, California

The SPS is the largest space system conceived to date that appears feasible with reasonable extensions of existing control technology. It represents a class of large platform-like structures (Fig. 1) that are several orders of magnitude larger than any of the other large space systems (multiple-payload platforms, parabolic reflectors, etc.) currently in planning within NASA. The SPS has in common with all large space systems many control problems that are widely recognized within the controls community. These problems include attitude errors due to disturbances, potential instabilities due to truncated modes and other model errors, lack of damping, and inaccurate preflight knowledge of the vehicle dynamics. The qualitative nature of these problems (model errors, concentrated stresses due to large actuator size, etc.) has emerged as a result of studies in the general area of control of large space structures. However, there is a need at this time, to investigate the dynamics and control problems specifically related to the Satellite Power System (SPS), to assess performance of selected control concepts, and to identify and initiate development of advanced control technology that would enhance feasibility and performance of the SPS system. This paper reports on the initial stages of such a study.

One of the areas that has been under intense investigation is that of modeling for controller design. This is widely recognized to be a major and as yet unsolved problem in achieving precise control of large space systems (Fig. 2). This problem arises because, to satisfy performance requirements, the control system must have the means for predicting very accurately the vehicle dynamic response. This is done with a dynamical model that constitutes an integral part of the control system design. The resulting performance is critically dependent on the accuracy of this model. Paradoxically, development and on-board implementation of precise large structure models is difficult if not impossible because of the many degrees-of-freedom, nonlinearities, parameter uncertainties, difficulties in pre-flight dynamics testing, and limitations

in on-board computational capability. Hence, the model in the control system design is at best a truncated approximation of the actual vehicle dynamics. A systematic selection of this approximate model is required in order to retain the significant vehicle dynamics in the controller design, to optimize on-board computations and to ensure satisfactory control in spite of the inevitable model errors.

Three distinct approaches have been developed in order to systematically select the controller design model (Fig. 3). The models consist of a hinge-connected multibody model to conduct attitude dynamics and control studies, a continuum model to perform parametric studies of control/structure interaction dynamics and a complete flexible multibody model for performance prediction based on a comprehensive description of the vehicle dynamics. Parametric analysis based on these models has revealed properties of vehicle dynamics (such as mode shapes and frequencies) in terms of the structural parameters (Fig. 4). This parametric model has been used to demonstrate the application of system identification techniques to the SPS dynamics and control. A quasi-inertial mode of operation (Figs. 5-7) has been assessed parametrically and the role of damping on the attitude dynamics investigated. Structural deformations and local slopes arising as a result of dynamic load conditions have been obtained and related to the pointing accuracy and transmitting efficiency of the microwave transmission system (Fig. 8). Current efforts are directed toward application of distributed control and shape determination concepts to the collector and antenna models.

CONFIGURATION

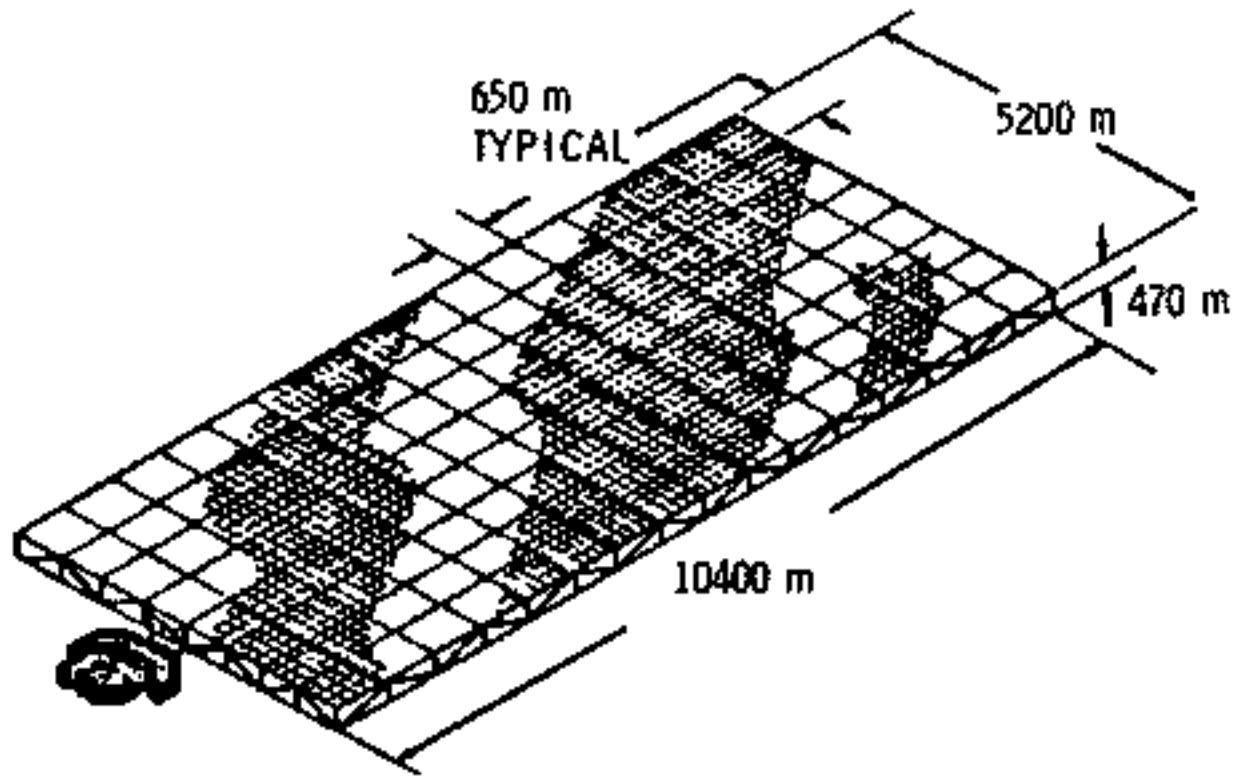

FIG. 1

LARGE SPACE SYSTEM

- NON LINEAR
- INFINITE DEGREES OF FREEDOM
- EXTERNAL DISTURBANCES
- FLEXIBILITY
- PARAMETER CHANGES
- CONFIGURATIONS CHANGES
- CONTROL INTERACTIONS

GROUND EVALUATION MODEL

- LINEAR
- FINITE ELEMENTS
- MODAL

ON-BOARD MODEL

CONTROLLER MODEL

- LARGE STRUCTURES ARE INFINITE-DIMENSIONAL SYSTEMS THAT CANNOT BE COMPLETELY MODELED
- MODEL ORDER REDUCTION IS REQUIRED TO MINIMIZE ON-BOARD COMPUTATIONS AND IMPLEMENTATION COMPLEXITY

FIG. 2

CONTINUOUS MODEL

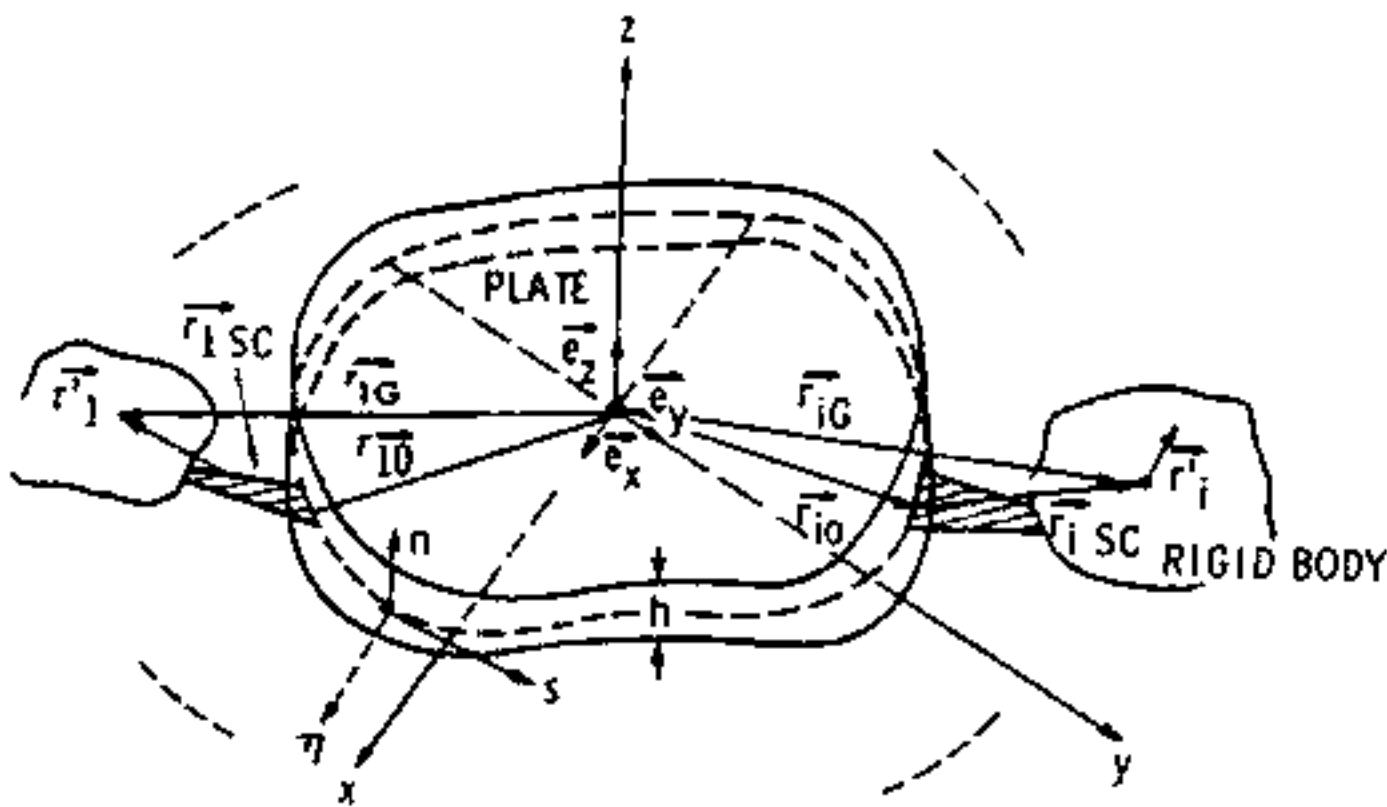

FIG. 3a

FLEXIBLE MULTI-BODY MODEL

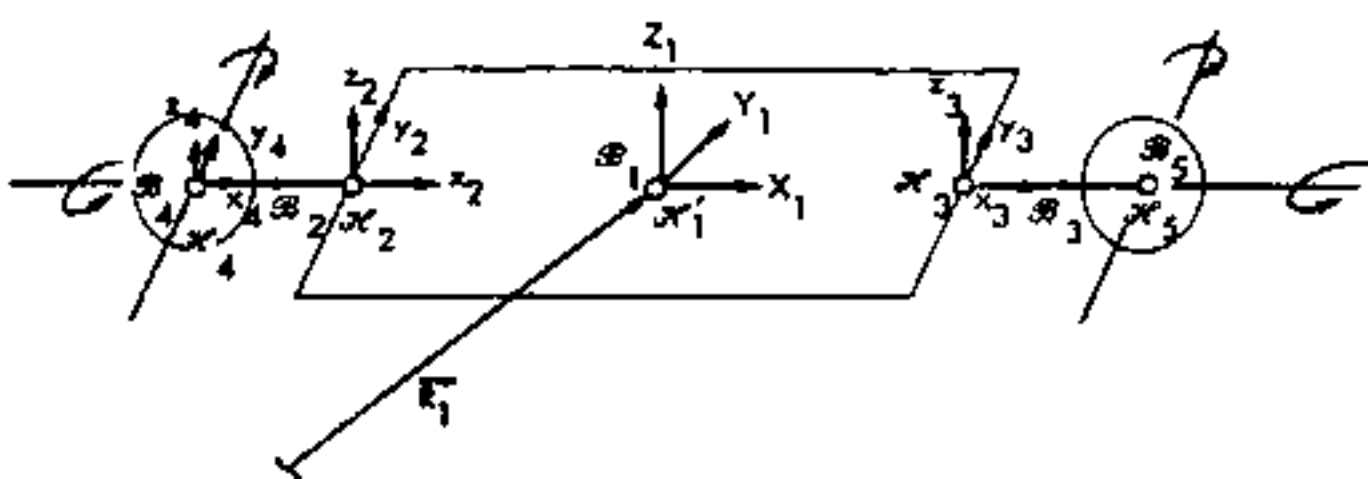

FIG. 3b

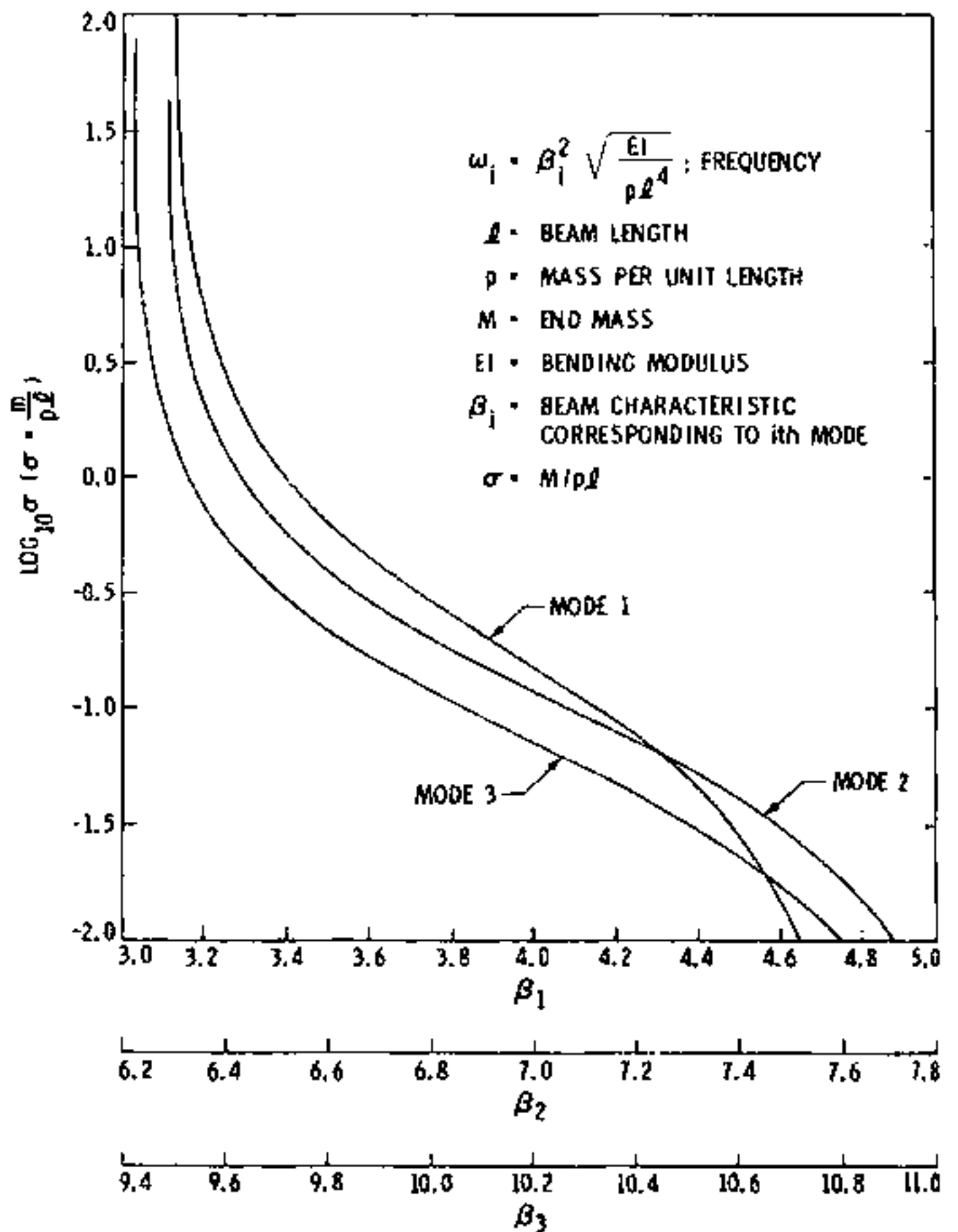

FIG. 4

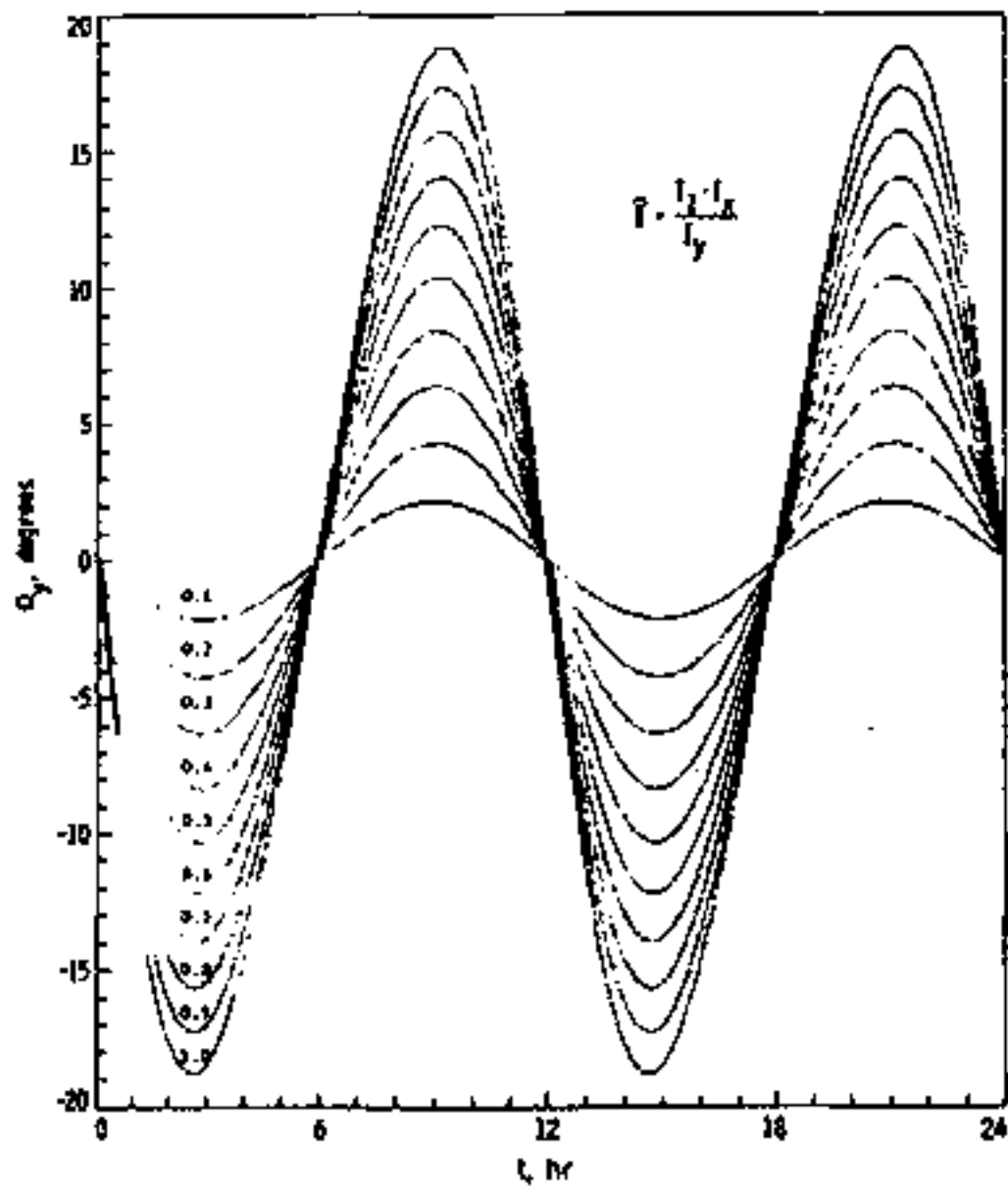

FIG. 5

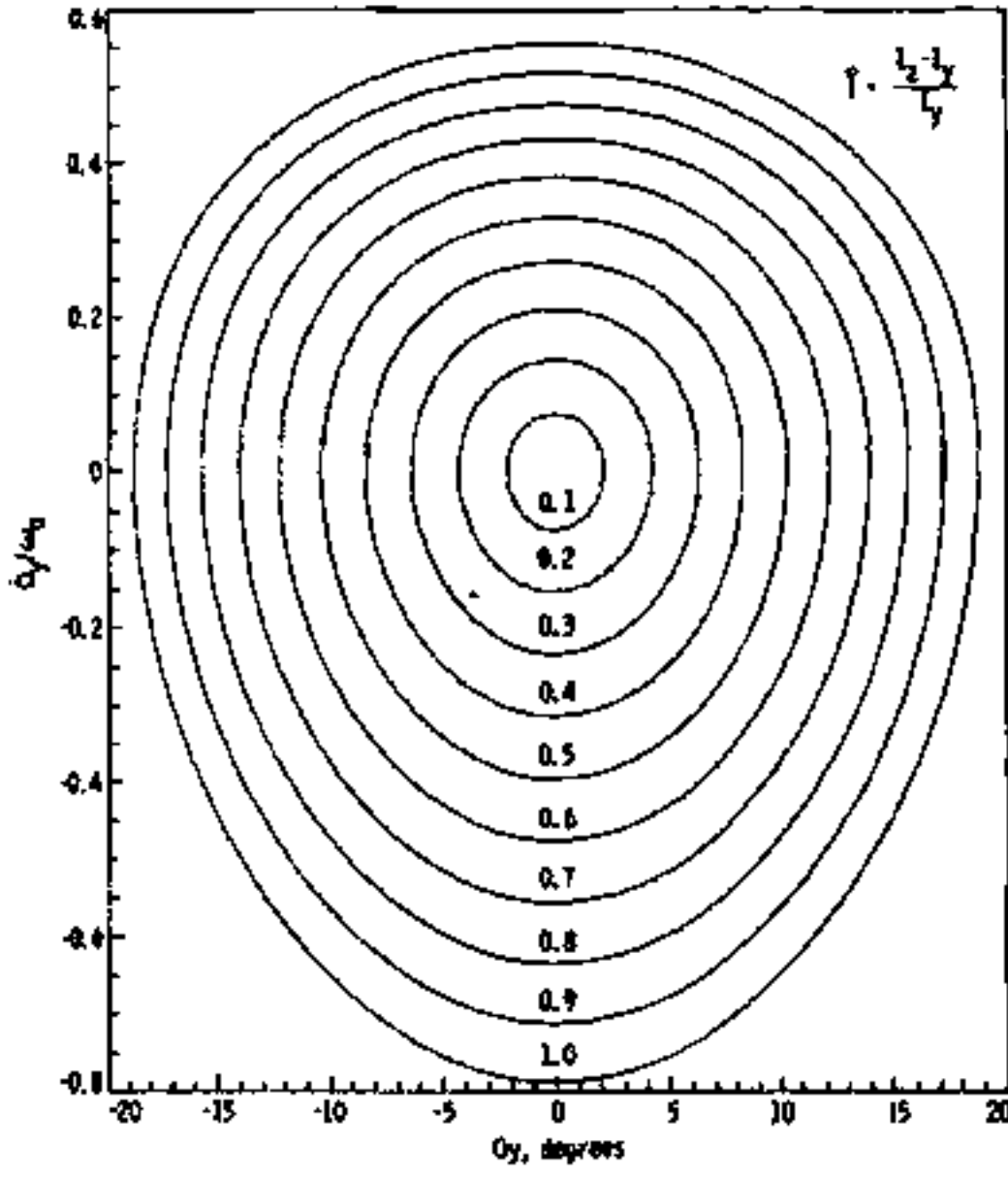

FIG. 6

ATTITUDE ERROR

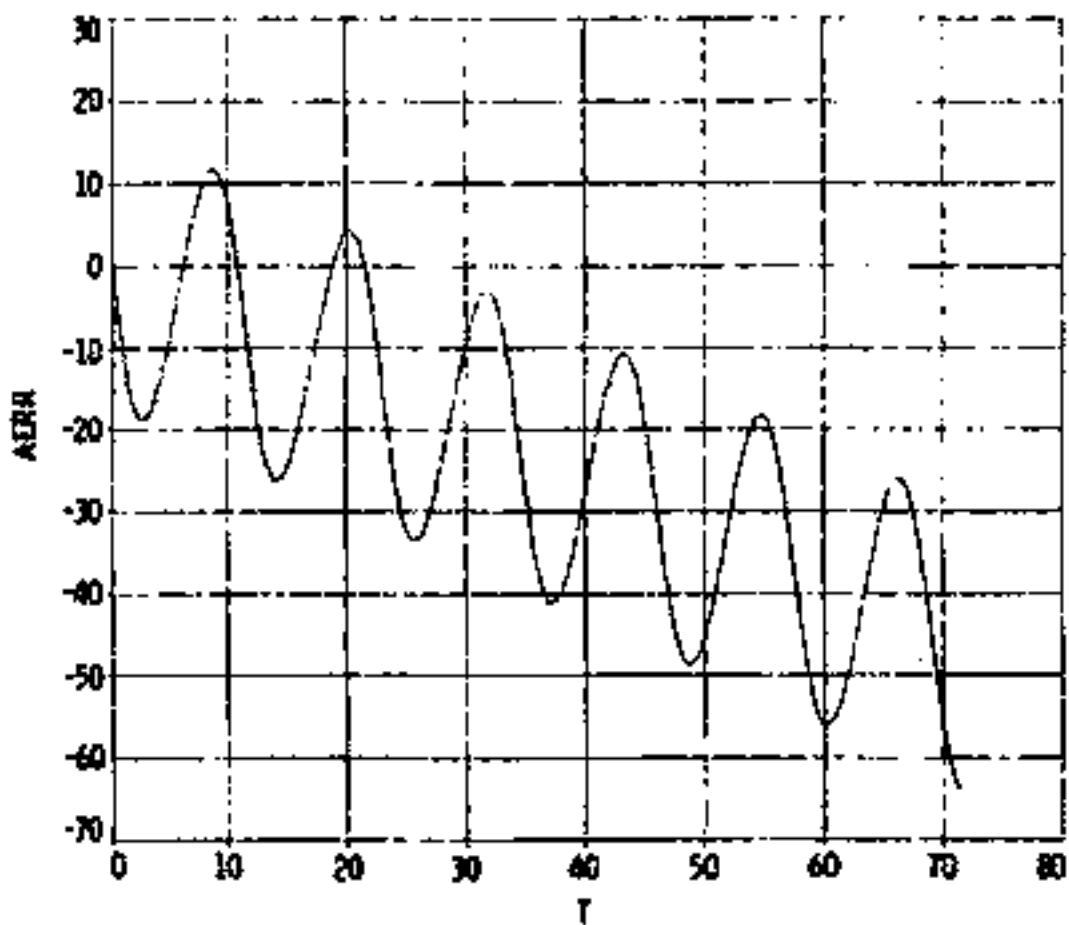

FIG. 7

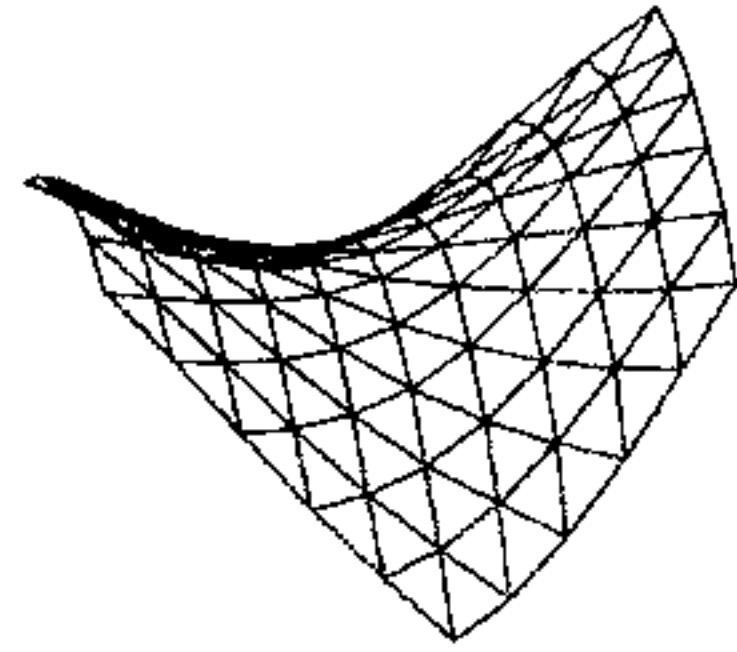

FIG. 8a

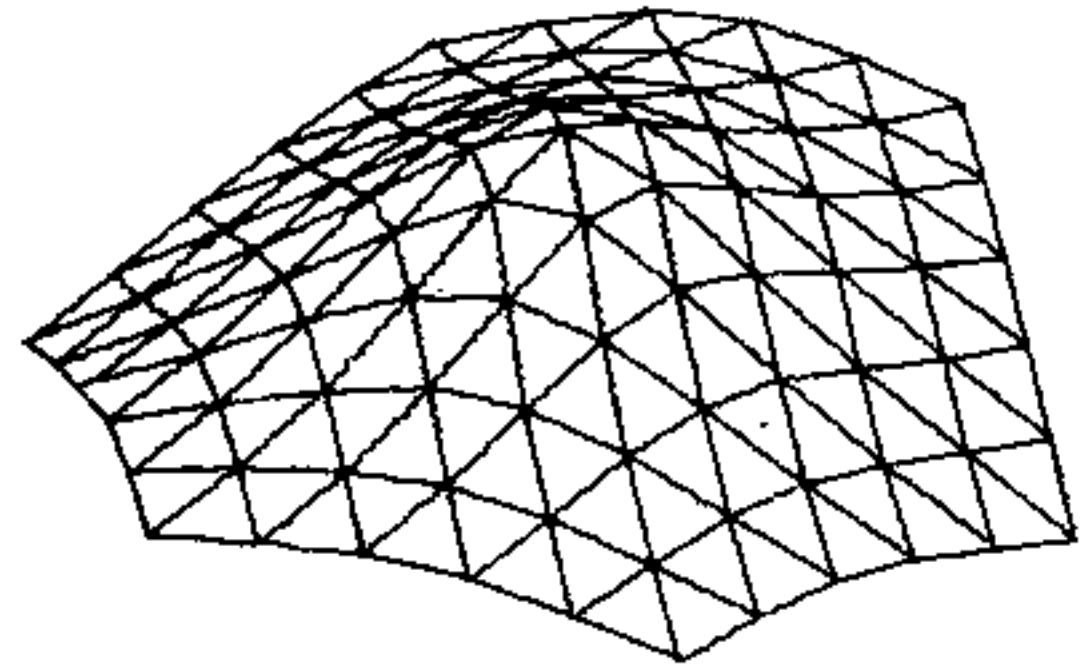

FIG. 8b

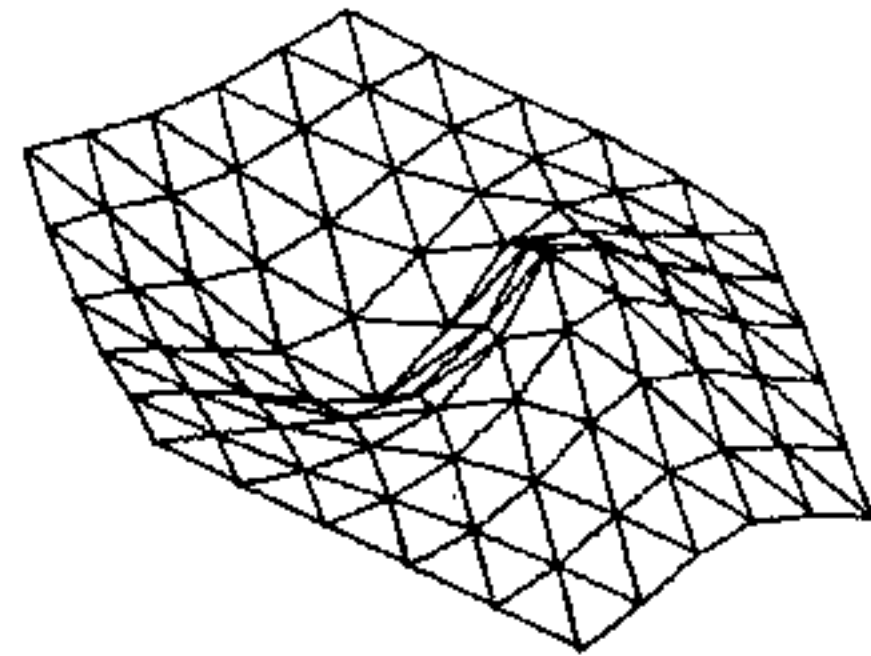

FIG. 8c

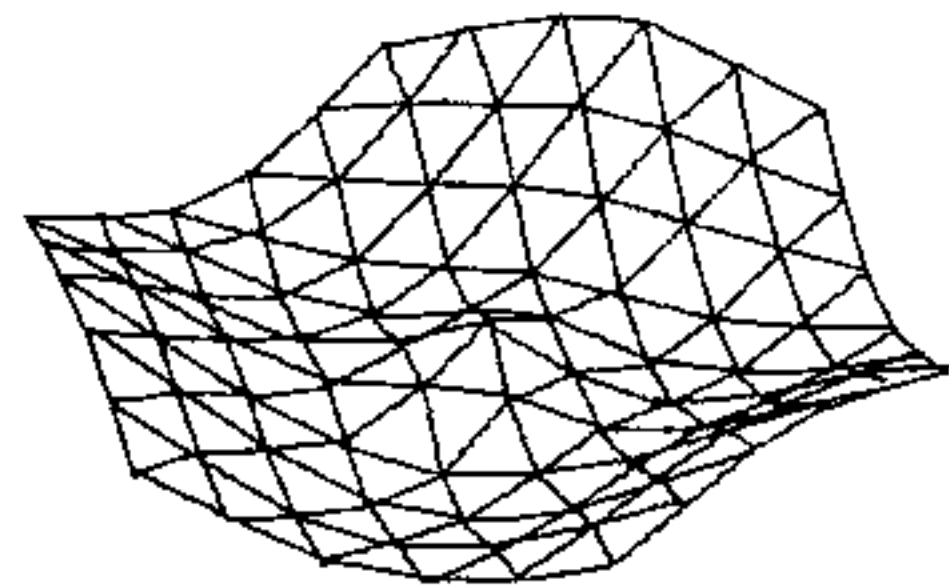

FIG. 8d

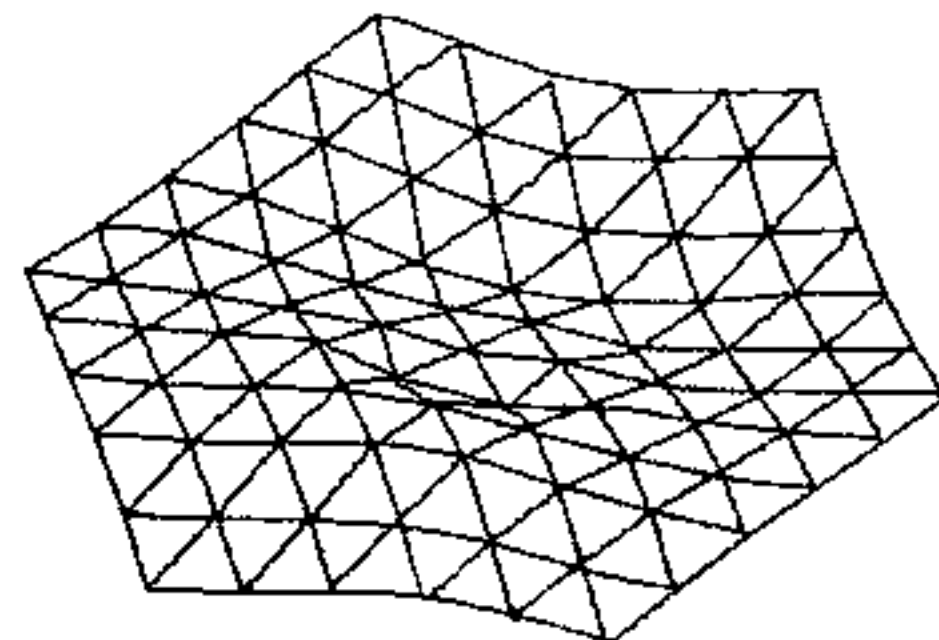

FIG. 8e

The Problem

The structural dynamics of the solar power satellite are complex. There are many low frequency vibration modes with frequencies that are closely clustered. In addition, the requirements on the vibration of the microwave antenna are very severe. Lastly, the possibility of thermal induced vibration is such that severe structural-thermal interactions are possible. One way of eliminating these problems is to design the structure stiff enough and with low coefficient of thermal expansion material so that the vibrations do not create a problem, and the thermal interactions can not occur. A second possibility is to use the active control system to mitigate the structural problems.

A cautionary note must be sounded. The first approach might actually exacerbate the structural problem if the control system were designed without consideration of the structural dynamics. This comes from the interaction of the control actuators and the sensors with the vibration of the structure. The so called "control and observation spill-over" problem is so important that it must be kept in view as one goes about developing the control system. Since the detailed structural, thermal and control models are required to guarantee that spill-over does not occur, it makes sense to evaluate other advantages that a complex control system may provide. One possibility is that the control system will permit lighter structural material with lower stiffness, the loss of structural stiffness being overcome by the active control system. Figure 1 shows the spill-over problem and the potential solutions to the problem.

The Approach

There are several distinct avenues that one may follow if the control system is designed using modern control methods. These are:

- Design of an optimal controller with an estimator (Kalman Filter) to reconstruct the missing measurements of the structural motion.
- Design of a control system that uses only measurements, that is with no estimation of the missing dynamic states. This is sometimes called direct output feedback.
- Design of a control system on a very limited set of models and then adaptively modify the control system during its operation.

Fig. 1 illustrates the first two of these techniques. The emphasis in this presentation is on the second of the approaches, since this seems the most robust method. In the context of modern control, the term robust has a very specific meaning. A control system is robust if the variations in the parameters of the system being controlled do not alter the stability, and if the expected parameter variations do not dramatically alter the response.

The robustness results that are available from the modern optimal control techniques are the following:

- A control system that uses "full state feedback" (i.e. for each state in the system there is a feedback gain to each control), has infinite gain margin when used in the system whose model was used for the design.
- A control system that is optimal has at least 60° of phase margin.
- A control system that is optimal and that is designed with an integral compensation in each control channel, is more robust than one without

integral compensation.

The procedure for accomplishing the design of the optimal robust control is as follows:

- Step 1- Develop a model that includes the rigid body dynamics, the gravity gradient dynamics, the rotational dynamics of any controllers that are included, the flexible dynamics through a large finite element model of the structure, and any significant thermal/structural interactions.
- Step 2- Reduce the dimension of the model. This is a key step since the validity of the robustness results depends on the minimization of spill-over which takes place at this step. Order reduction techniques include methods based on singular perturbation, variable time scale, or modal truncation based on cost of control.
- Step 3- Design the control system using the model of step 2 and a performance measure for the quality of control that penalizes motions in regions of the structure where loads must be reduced, and also gives the overall rigid body control performance that is required (pointing of the microwave antenna to some specified angle, for example).
- Step 4- Verify the design of step 2 on a larger dimension version of the dynamic model than was used to develop the design. This is necessary because the only way one can evaluate the spill-over effect is with a dynamic model that is of larger dimension than the design model.
- Step 5- Repeat steps 2,3, and 4 until the design has the desired level of robustness for typical parameter uncertainties in the structural and control actuator dynamics.

The effectiveness of this approach as a design technique relies on the fact that any infinite dimensional system may be evaluated on a sufficiently large finite dimensional approximation, as long as the control system has a specified high frequency characteristic. In the case of optimal designs, this characteristic is the roll off of the control, at the higher frequencies, that is at least 20 db/ decade.

An Example

Figure 2 shows a structure that was used to evaluate the design procedure described above. This structure was an earlier version of a space construction base that was developed by Grumman for JSC. The controller was asked to reduce the motion of the solar array, while stabilizing an unstable gravity gradient orientation. In addition the pointing of the overall system was to be insured. The actuators consisted of only the rigid body actuators which were three orthogonal control moment gyroscopes mounted close to the shuttle attachment point at the bottom of the mast that carries the solar array and construction boom. The control sensors were a set of 52 strain sensors (26 strain gages configured in such a way that both strain and strain rate were sensed), plus the normal complement of rigid body sensors (attitude and rate in each axis). The resulting design is extremely robust, and the verification on the higher dimension model has been formulated as a 16 mm movie that shows precisely how the control operation helps damp the solar array vibration while maintaining rigid body control despite the unstable gravity gradient torques.

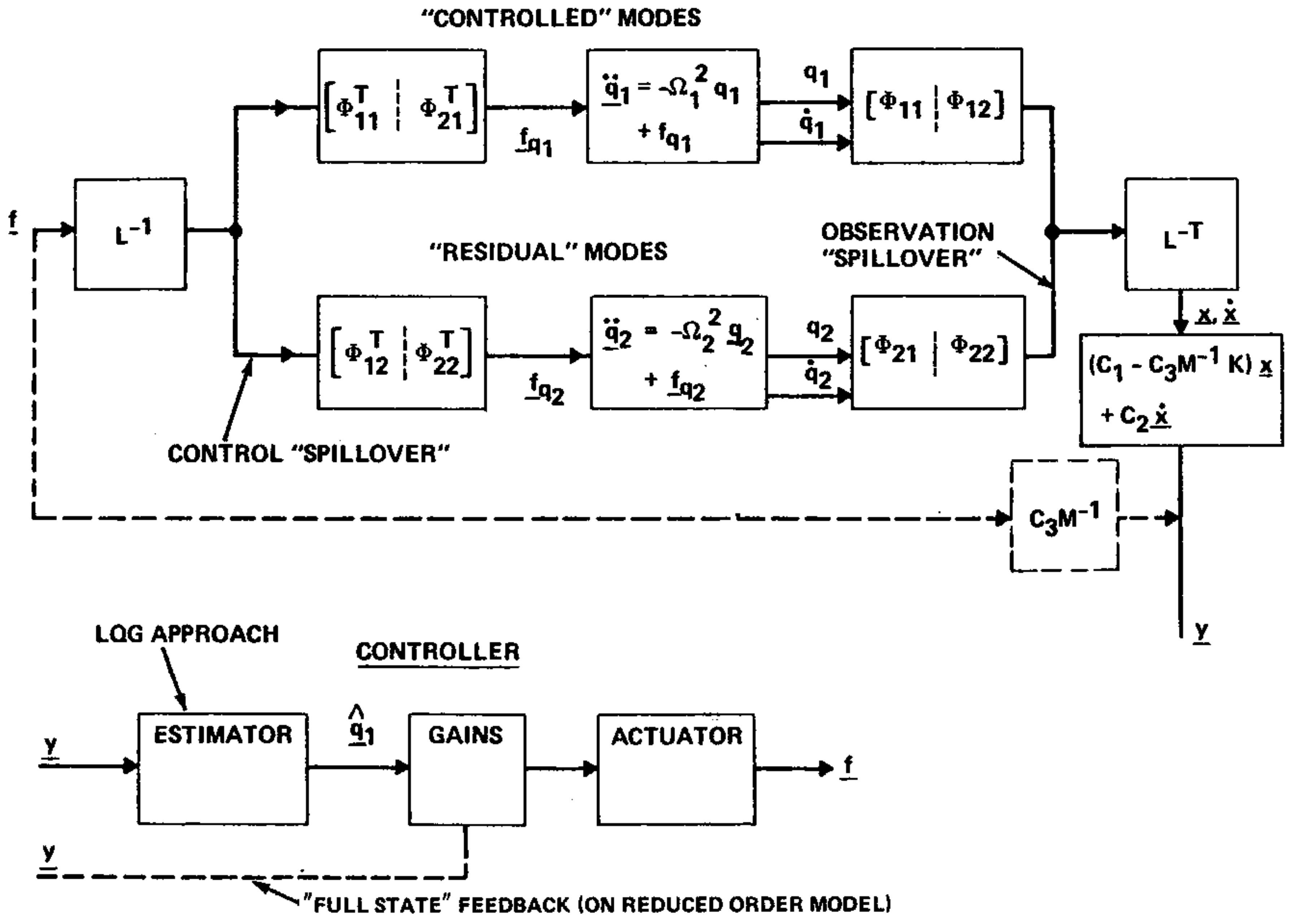

Fig. 1 Control Approaches to Spillover Elimination

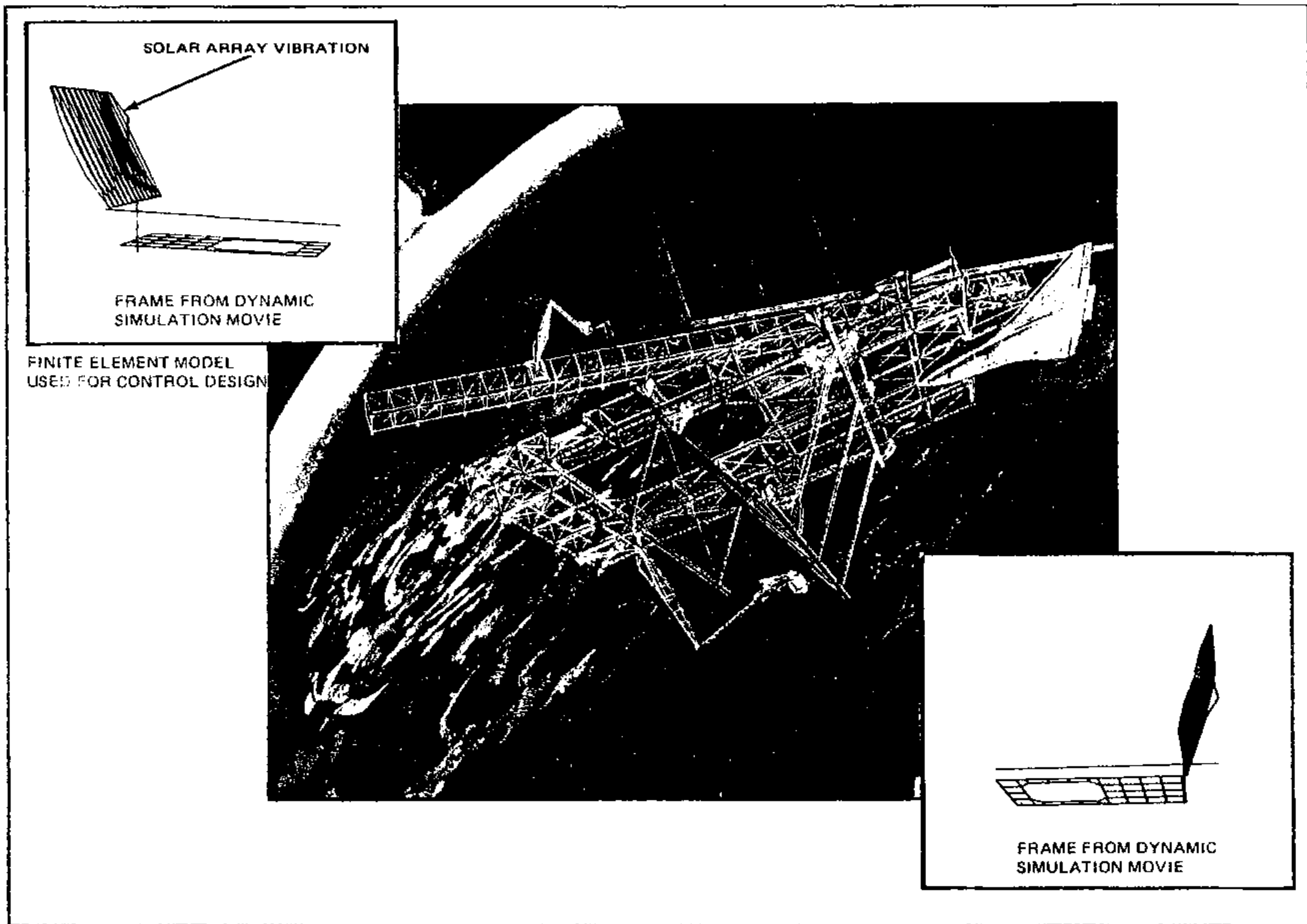

Fig. 2 Orbital Construction Demonstration Article

ACTIVE CONTROL OF DEFLECTIONS IN SPACE STRUCTURES

Jonathan Leavitt

A. Epstein & Sons, Inc. - Chicago, Illinois 60632

As a structure increases in size it becomes increasingly less rigid in proportion to its linear dimensions. For deployable structures on the order of kilometers in size the maximum allowable deflection will certainly be a significant factor in the structural design. Especially if a flexible structure is to resist dynamic loads encountered during construction and maneuvering and still have minimal mass, some method of actively controlling deflections may be required.

Dimensional relationships between such properties as strength, static deflection, stiffness, frequency of vibration, and thermally induced deflection are related to system mass and size. Criteria involving these parameters are explored as a guide to establishing the structural performance needed for large antenna arrays.

The need for active control of deflections will then be described in terms of increasing linear dimensions and system mass. For structures of various scales different control systems are preferred.

[Extended Abstract Not Received]

THE DESIGN OF LOW-COST STRUCTURES FOR EXTENSIVE GROUND ARRAYS
H. A. Franklin and R. S. Leonard
Bechtel National, Inc., San Francisco, California

There is a great deal of similarity between the functional requirements for support structures for flat plate photovoltaic arrays and for the Satellite Power System (SPS) rectenna panels. Much work relevant to the SPS rectenna design effort has been done on developing design criteria and structural designs for low-cost support structures for terrestrial photovoltaic power plants.

This paper reports on the work done by Bechtel National, Inc. for Sandia Laboratories to develop conceptual designs of solar array support structures and their foundations including considerations of the use of concrete, steel, aluminum, or timber. Some cost trends were examined by varying selected parameters to determine optimum configurations. Detailed civil/structural design criteria were developed during this work. Using these criteria, eight detailed designs for support structures and foundations were developed and cost estimates were made. Cost estimates for array supports and foundations were shown to vary between \$2 to \$3 per square foot of supported panels (deflated to 1975 dollars).

A result of this study was to identify wind as the major loading experienced by these low-height structures, whose arrays are likely to extend over large tracts of land. The proper wind load estimating is essential to developing realistic structural designs and achieving minimum cost support structures. Existing building codes are not directly applicable for determining the wind loads on these structures. Consequently, wind tunnel testing of a conceptual array field was undertaken and some of the resulting wind design criteria are presented in this paper. SPS rectenna system designs may be less sensitive to wind load estimates, but consistent design criteria will remain important.

Concepts: In developing low cost support concepts for either the terrestrial photovoltaic power plants or SPS ground stations the functional requirements must be well understood. Some of these are:

- spacing requirements to avoid shading
- construction and maintenance access requirements
- environmental restrictions and construction materials (rusting, wood rot, degradation due to UV)
- size limitations due to transportation
- reflection/vibration limits

Concepts considered ranged from panels placed directly on the ground to having the energy collection system integrated into the sloping roof of a large building structure which also houses office and condominiums. Various foundation concepts were also reviewed. After a preliminary screening, the main study effort concentrated on simple structures made up of posts and beams. The posts were supported on caissons or footings, or were directly embedded in the ground. Several of these concepts are shown in the following pages.

Design Criteria: These low (close to the ground) light-weight structures are not governed by any of the existing categories of building codes such as the Uniform Building Code (UBC) or American National Standards Institute (ANSI) A.58.1-1972 "Building Code Requirements for Maximum Design Loads in Buildings and Other Structures." Yet for studies whose results will be widely used to

determine the economic feasibility of concepts, it is important to have specific design criteria.

Design criteria developed during the study of low cost structures for photovoltaic arrays addressed types of load, nature of the loading function (known/unknown, variable, upper bound) and risk of occurrence of the loads. The design criteria were developed along the lines of the above codes and used, in addition to those codes, the results of current research in assessment of risk and wind loading of civil engineering structures.

Cost Trends and Costs: A number of factors affect cost trends. Some of these are:

- cost of labor to install support components such as posts and beams declines as a function of $1/n$ where n is the number of panels supported per span
- material required for beams increases as a function of L^2 , where L is the distance between supports
- material required for foundations increases as a linear function of load on the columns or posts

The effects of combining these trends are shown in the attached figures...

Wind Design Studies: Usual design procedures like those given in ANSI A58.1-1972 are not adequate for accurate wind design of repetitive arrays of sloping solar panels set at a low height above the terrain. The technical literature provides little information even for a single array. Hence the wind tunnel test program was performed in 1979 for single flat panel arrays and for a field of such arrays. The 1:24 scale models were tested in the Meteorological Wind Tunnel at the Colorado State Fluid Dynamics Laboratory at Fort Collins, utilizing a boundary layer feature to generate terrain turbulence. Measurements were made of the effects of panel slopes, wind azimuth, panel porosity and height above the ground, and for the effects of wind barriers. The height above ground and changes in panel porosity, to the amount deemed reasonable for solar panels, were found not to have much effect on wind forces. On the other hand, porous fences provided large reductions in wind forces on either single arrays or on parts of array fields. Wind force coefficients derived from these studies are recommended for the wind design of similar solar panel installations. These are intended to represent mean wind effects and do not include wind dynamics. Existing methods for gust force design are recommended at this time.

THIS ASSUMES INSTALLATION OF LOW PANEL ARRAYS
USING COVENTIONAL EQUIPMENT

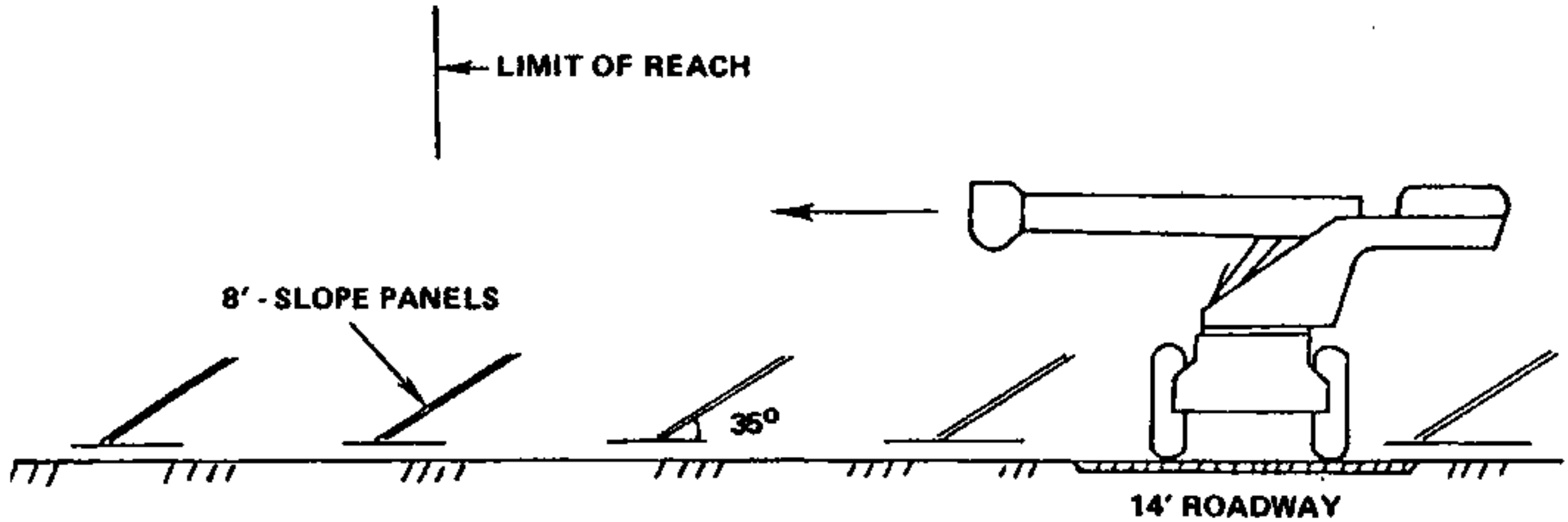

ARRAY SPACING AND ROADWAY ALLOCATIONS

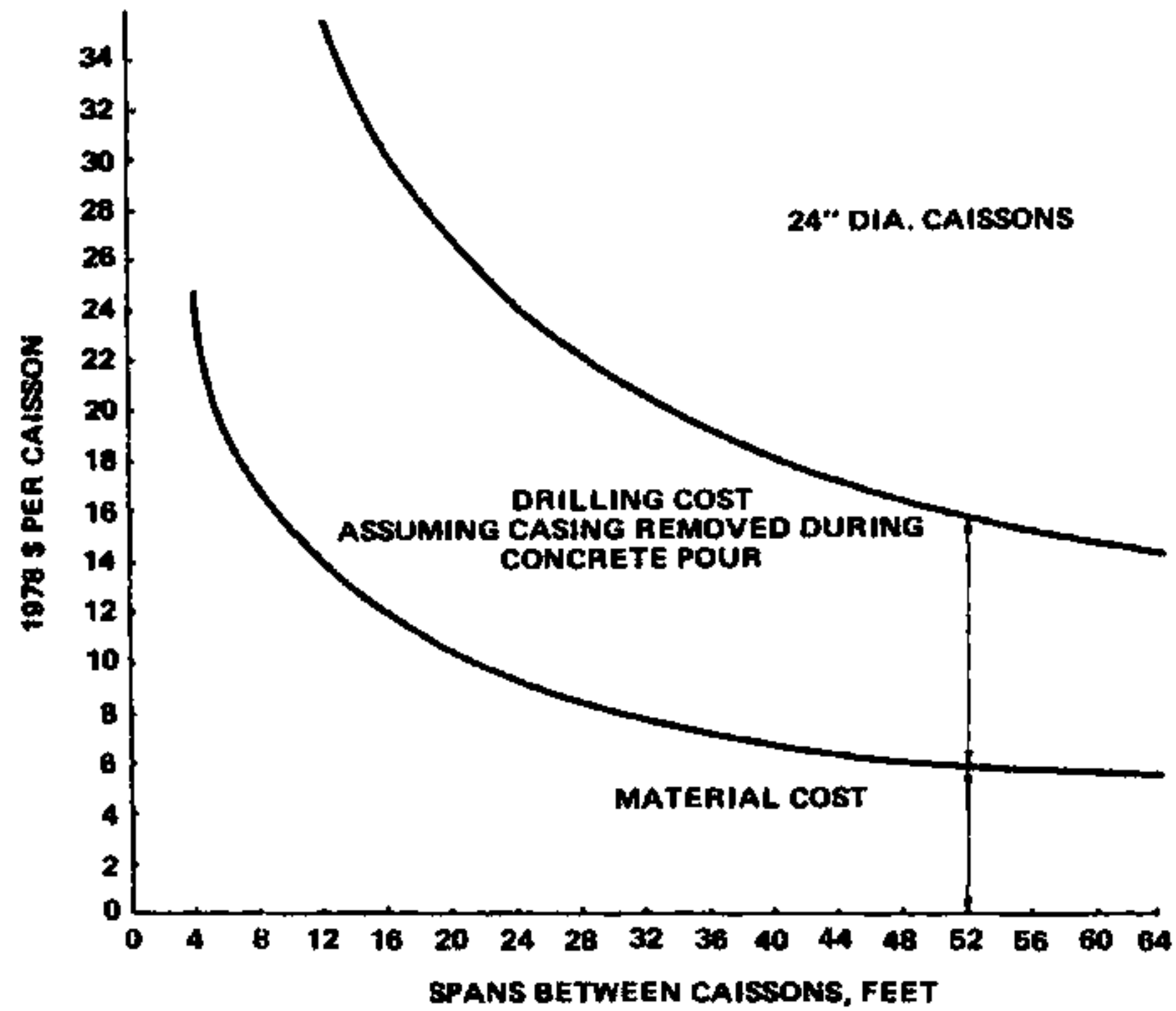

PRELIMINARY COST ESTIMATES
FOR 24" DIAMETER CAISSONS

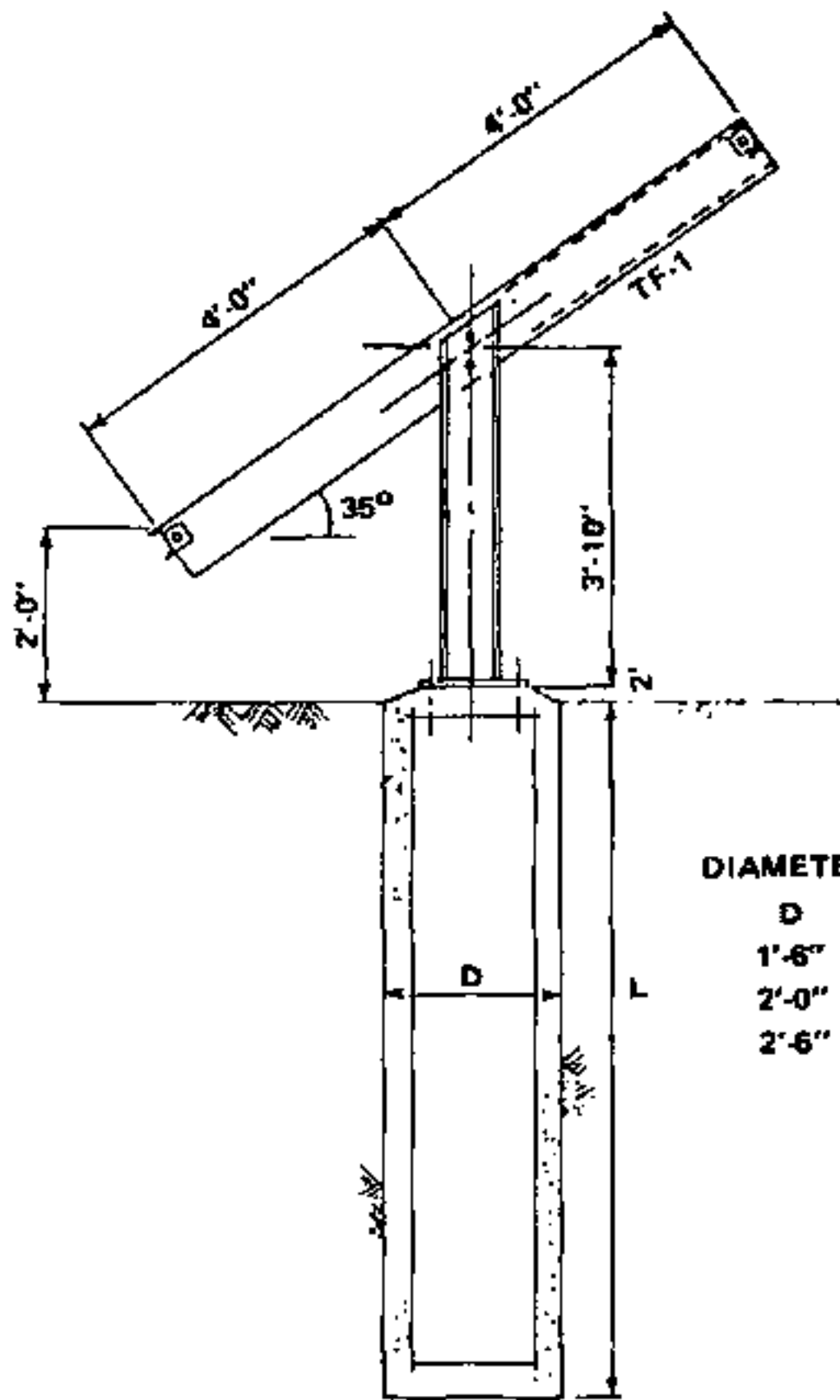

DIAMETER	LENGTH
D	L
1'-6"	9'-0"
2'-0"	8'-0"
2'-6"	7'-0"

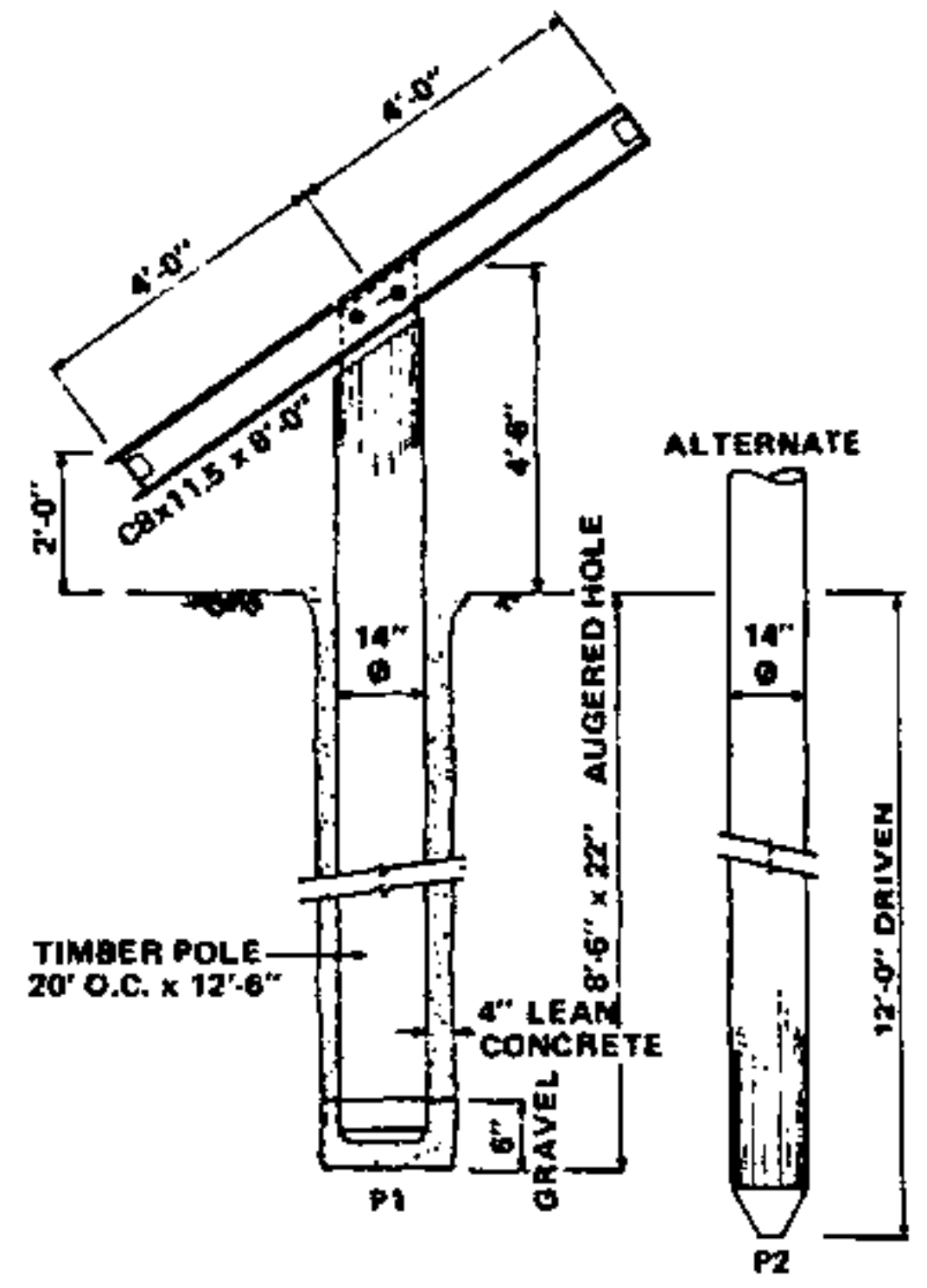

**POLE FOUNDATIONS P1 AND P2
8' x 20' ARRAYS**

VERTICAL CAISSON F-3, 8' x 20' ARRAYS

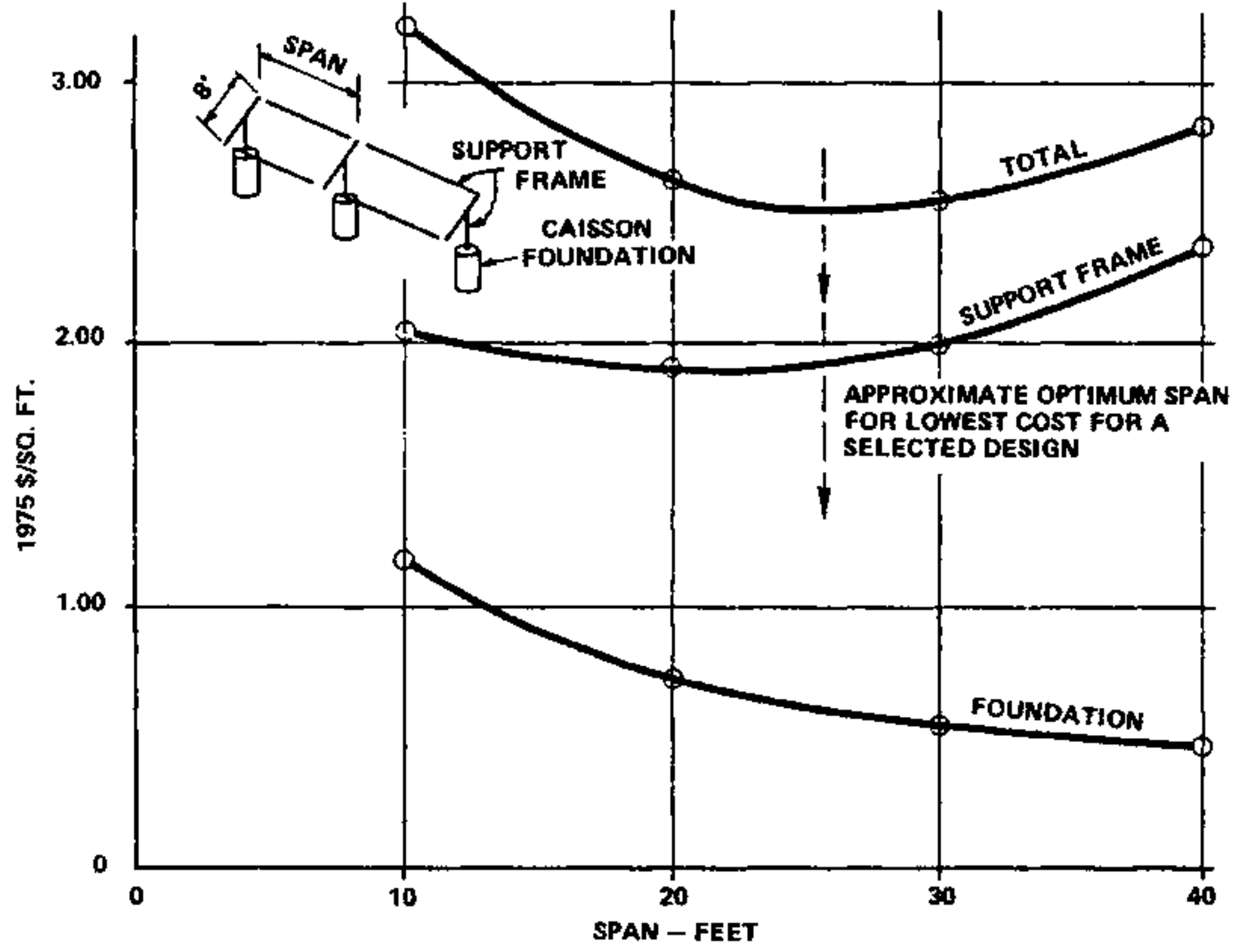

SPS STRUCTURAL DYNAMICS AND CONTROL WORKSHOP: FINDINGS AND RECOMMENDATIONS

R. C. Ried - NASA/JSC, Houston, Texas

D. L. Mingori - University of California, Los Angeles, California

Recently a technical workshop was held at the Johnson Space Center to examine issues related to the structural dynamics and control of the Solar Power Satellite (SPS), a concept which holds promise for meeting a portion of the energy needs of the United States beyond the year 2000. The panel members, listed in Figure 1, represent some of the nation's leading experts in controls, structural dynamics, structures and materials. As listed in Figure 2, the objectives of the workshop were for this panel to: 1) assess and critique the assumptions, methodologies and conclusions of existing SPS studies in the areas of structural dynamics and control (with structural design and materials also being considered) and 2) identify critical issues in these areas and make recommendations for future work. Within the time and resources available it was not possible to provide the panel with a comprehensive review of the overall SPS system characteristics or to penetrate into the intersystem design issues and tradeoffs. In fact the workshop was only able to highlight the activities in structures, control and materials. In spite of these limitations the panel has afforded an excellent review and developed a valid perception as to the status of the SPS work in their areas of expertise. This paper is based on preliminary inputs from the panel members. The official panel findings are expressed in the panel's final report.

Comments and recommendations given include six categories as briefly addressed in:

- Figure 3. Modeling/Dynamic Analysis of the Uncontrolled System
- Figure 4. Structural Design
- Figure 5. Control System Analysis/Design
- Figure 6. Construction in Space
- Figure 7. Structural Materials
- Figure 8. Experiments

A seventh category, manned safety, was pointed out by the panel as an important factor to all aspects of system design, construction, maintenance and operation.

After considering each of these areas, the panel would like to have stated with some confidence that all of the problem areas had been brought to light and shown to be resolvable. In fact, they are generally optimistic that if sufficient resources are devoted to this effort, the same kind of technical know-how that has served us in the past will find ways to meet the challenges presented by the SPS. At the present time, however, such optimism would be based more on wishes and past success than on hard evidence. The work to date has simply not gone far enough or looked deep enough to provide real confidence in the ultimate viability of the SPS. A substantial amount of work must be done in areas like modeling, developing techniques for the active control of uncertain systems, and studying the long term physical properties of composites before this confidence will be warranted. Meanwhile, optimism must be balanced by a certain amount of caution combined with the determination to develop the tools and knowledge necessary to see if this much needed dream can be turned into reality.

Since the SPS system cannot be tested in the terrestrial environment, many types of experimental verification techniques possible for more conventional engineering projects are ruled out. Thus, the successful design, development and con-

struction of the SPS will rely to an unusually high degree on modeling and dynamic analysis. The panel feels that substantial further work is required in the areas of modeling the system components and environment. These models are required to study the uncontrolled behavior of the spacecraft and to provide a basis for the control system design, development, and evaluation. It may be necessary to predict reliably hundreds or thousands of structural frequencies, mode shapes and damping ratios. Currently modeling procedures for structural dynamics are not so clearly established as to be able to estimate the reliability of a particular eigenvalue and eigenvector. Environmental disturbances and control hardware must also be modeled to assess system behavior and for suitable control system design.

Current SPS structural designs utilize forms which basically derive from 19th century bridge-building technology (not necessarily bad). As the overall concept evolves, as communication is developed between structures, materials and control specialists, and as an understanding of construction in space is developed, it is anticipated that more advanced concepts which exploit the potential of the nearly benign environment will emerge.

To approach this evolution, however, the panel felt that the controls problem had received disproportionately little attention. This included: recognition of modeling limitations as a key issue, tradeoffs among active surface control, tradeoffs between the bounds of structure and control, tradeoffs between electronic phasing and active figure control, analyses which penetrate to adequate depth for specific controls hardware considerations, and means to accomplish verification of the controlled system design. The controls problem for construction is compounded by the additional parameters of transient geometry and performance requirements.

A feature of the SPS which sets it apart from all spacecraft launched to date is the fact that it must be constructed automatically in space. Our lack of experience with systems of this type merits careful consideration of this feature. The construction phase may in fact be critical in terms of establishing structural and control system design requirements.

The panel felt that much additional work was required to provide a confidence level necessary for the selection of graphite composite as the SPS structural material. There are a number of design/structure/material tradeoff studies which should be performed. The basic question of the long term stability of materials and coatings in the space environment is crucial.

As outlined in Figure 8, the nature of the SPS is such that the design and proof of feasibility will rest primarily on a foundation of analysis. However, experiments are needed to verify the results of analysis insofar as possible. These experiments should be directed toward verification of modeling techniques, validation of control policies, and determination of material properties.

SPS STRUCTURES & CONTROL WORKSHOP
AT
NASA, JSC JANUARY 22, 23, 1980

CHAIRMAN: D. L. KINGORI - UNIVERSITY OF CALIFORNIA, L. A.
PANEL MEMBERS: K. T. ALFRIEND - NAVAL RESEARCH LABS
R. G. LOEWY - RENSSELAER POLYTECHNIC INSTITUTE
M. LYONS - LOCKHEED RESEARCH LABS
S. SELTZER - CONTROL DYNAMICS COMPANY
R. E. SKELTON - PURDUE UNIVERSITY
K. SOOSAAR - C. S. DRAPER LABS

FIGURE 1 - SPS STRUCTURES & CONTROL WORKSHOP PANEL

OBJECTIVES:

- ASSESS & CRITIQUE ASSUMPTIONS, METHODOLOGIES & CONCLUSIONS OF EXISTING SPS STUDIES IN THE AREAS OF STRUCTURAL DYNAMICS & CONTROL (STRUCTURAL DESIGN & MATERIALS ALSO CONSIDERED)
- IDENTIFY CRITICAL ISSUES IN THESE AREAS AND MAKE RECOMMENDATIONS FOR FUTURE WORK

SUMMARY OF FINDINGS:

- GENERALLY OPTIMISTIC THAT WITH SUFFICIENT RESOURCES TECHNICAL KNOW-HOW THAT HAS SERVED US IN THE PAST WILL FIND WAYS TO MEET SPS CHALLENGES, BUT WORK TO DATE HAS NOT PENETRATED ENOUGH TO PROVIDE REAL CONFIDENCE IN THE ULTIMATE VIABILITY OF SPS FROM THE STANDPOINT OF STRUCTURES AND CONTROLS. WORK REQUIRED IN:
 - MODELING
 - DEVELOPING TECHNIQUES FOR ACTIVE CONTROL OF UNCERTAIN SYSTEMS
 - STUDY OF LONG TERM PROPERTIES OF COMPOSITES

FIGURE 2 - WORKSHOP OBJECTIVES & FINDINGS

ISSUE:

SUCCESSFUL DESIGN & OPERATION OF SPS WILL RELY HEAVILY ON MODELING & DYNAMIC ANALYSIS

RECOMMENDATIONS:

- ADEQUATE MODAL ANALYSIS WILL REQUIRE DEVELOPMENT OF:
 - HIGHER ACCURACY FINITE ELEMENTS
 - IMPROVED EIGENVALUE EXTRACTION
 - CAREFUL ANALYSIS OF ERROR SOURCES
- NEED BETTER UNDERSTANDING OF HOW MODELING CRITERIA AFFECT RELIABILITY OF MODE SHAPES, FREQUENCIES
- ENVIRONMENTAL DISTURBANCE, & CONTROL HARDWARE MODELING REQUIRED FOR DYNAMIC PERFORMANCE & CONTROL SYSTEM DESIGN
- EXTEND FINITE ELEMENT ANALYSIS TO INCLUDE NON-LINEAR BEHAVIOR FOR, EG.
 - POTENTIAL LARGE SOLAR BLANKET DEFLECTIONS
 - NEAR BUCKLING MEMBER BEHAVIOR

FIGURE 3 - MODELING/DYNAMIC ANALYSIS OF THE UNCONTROLLED SYSTEM

ISSUES:

- PANEL CONSENSUS SUPPORTED STRUCTURAL FEASIBILITY
- CONCERN EXPRESSED AS TO WHETHER THE EXPECTED LOW STRUCTURAL MASS FRACTION IS BASED ON A REALISTIC STRUCTURAL CONCEPT AND PROPER ANALYSIS

RECOMMENDATIONS:

- EXPLORATION OF MORE ADVANCED CONCEPTS WHICH UTILIZE FULL POTENTIAL OFFERED BY NEARLY BENIGN ENVIRONMENT
- MORE COMPREHENSIVE STRUCTURAL ANALYSES INCLUDING CONTROL ACTUATORS AND TRANSIENT, NON-UNIFORM THERMAL ENVIRONMENT

FIGURE 4 - STRUCTURAL DESIGN

ISSUES:

- SIGNIFICANCE OF MODELING ERRORS ON PERFORMANCE IS A KEY ISSUE FOR CONTROL SYSTEM ANALYSIS & DESIGN
- TRADEOFFS AMONG ACTIVE SURFACE CONTROL MAY LEAD TO MORE EFFICIENT DESIGN (POTENTIAL DYNAMIC/MICROWAVE PHASING INTERACTION)
- SPECIFIC CONTROLS HARDWARE MAY IMPACT OVERALL DESIGN
- STRUCTURE, CONTROL & MATERIALS DESIGN AND DEVELOPMENT SHOULD BE CARRIED ON IN PARALLEL WITH ADEQUATE COOPERATION, COMMUNICATION AND FUNDING. CONTROL HAS NOT RECEIVED APPROPRIATE ATTENTION

RECOMMENDATIONS:

- BETTER MATHEMATICAL METHODS NEED DEVELOPMENT FOR ROBUST CONTROL POLICIES
- MORE ATTENTION TO ORBITAL VERIFICATION OF CONTROLLED SYSTEM
- TRADE PASSIVE STRUCTURE/ACTIVE FIGURE CONTROL/ELECTRONIC PHASING (IMPACT MATERIAL, CONFIGURATION, RISK)
- CAREFUL STUDY OF ACTUATOR, SENSOR OPTIONS FOR IMPROVED CONTROL PERFORMANCE
- GREATER ATTENTION NEEDED ON CONTROL PROBLEM

FIGURE 5 - CONTROL SYSTEM ANALYSIS/DESIGN

ISSUES:

- LACK OF EXPERIENCE WITH SYSTEMS OF THIS TYPE MERITS CAREFUL CONSIDERATION
- MODELING AND CONTROL OF TRANSIENT PROPERTIES
- EFFECT OF THERMAL DEFORMATIONS ON ASSEMBLY

RECOMMENDATIONS:

- CONTROL UNDER CONSTRUCTION SHOULD BE ADDRESSED
- CONTROL THEORIES MUST BE DEVELOPED TO ACCOUNT FOR GROSSLY CHANGING PLANT
- STUDY OF STRUCTURES WITH MINIMUM REDUNDANCE
- ALTERNATE MEANS FOR HANDLING THERMAL DISTORTION BESIDES LOW CTE MATERIAL SHOULD BE STUDIED

FIGURE 6 - CONSTRUCTION IN SPACE

ISSUES:

- CURRENT FAVOR OF COMPOSITES MAY ULTIMATELY BE CORRECT BUT MUCH ADDITIONAL WORK REQUIRED TO MAKE THIS DECISION WITH CONFIDENCE
- LONG TERM STABILITY OF MATERIALS IN SPACE ENVIRONMENT
- DESIGN/STRUCTURE/MATERIAL TRADEOFFS

RECOMMENDATIONS:

- INVESTIGATE DESIGN SOLUTIONS TO EASE MATERIAL REQUIREMENTS (INCLUDING THERMAL CONTROL)
- EXPLORE USE OF OTHER MATERIALS SINCE COMPOSITES ARE RELATIVELY NEW
- DEVELOP PROCEDURES TO EXTRAPOLATE PERFORMANCE TO LONG LIFE (INCLUDING FATIGUE, THERMAL CYCLING, ENVIRONMENTAL EXPOSURE AND COMBINED EFFECTS)
- DEVELOP AUTOMATED FABRICATION OF STRUCTURAL ELEMENTS FOR GROUND SIMULATION; STRUCTURAL CHARACTERIZATION OF PRODUCTS
- ADDRESS THERMAL/MATERIAL PROBLEMS

FIGURE 7 - STRUCTURAL MATERIALS

ISSUES:

- SPS DESIGN AND DEVELOPMENT WILL DEPEND STRONGLY ON ANALYSIS AND MODELING
- MATERIAL PERFORMANCE/LIFE REQUIRES DATA

RECOMMENDATIONS:

- DEVELOP EXPERIMENTAL APPROACHES FOR VERIFICATION OF ANALYSIS AND MODELING (GROUND AND FLIGHT)
- CHARACTERIZE LIMITATIONS OF GROUND TESTING AND FLIGHT SCALE TESTING (CAN LEO TEST VERIFY FULL SCALE SYSTEM STABILITY?)
- DEVELOP SIMULATION CAPABILITY FOR APPLICATION TO EXPERIMENTS
- PLAN SCALE PROOF OF PRINCIPLE TESTING WHICH IS TECHNICALLY TRACEABLE TO FULL SCALE
- DEVELOP MATERIALS EXPERIMENTS

FIGURE 8 - EXPERIMENTS

SPS PROGRAM REVIEW TRANSPORTATION PERSPECTIVE
William W. Wales, Jr.
NASA - Marshall Space Flight Center, Alabama

During the past four years the NASA has teamed with various organizations in industry to assess the technical feasibility and economic viability of the Satellite Power System (SPS). The transportation system required to support this program played a significant role in answering these questions.

The SPS program requirement for the construction of two 35-million kilogram (5- GW) satellites each year demands that approximately 300,000 kilogram (660,000 pounds) of mass per day be delivered to the construction site, at geosynchronous orbit. The transportation system represents a significant part of the overall program cost, from 35-40 percent. Payload delivery cost goals of 15 to 30 dollars per kilogram of mass means that the system elements must have long life, short turnaround times with minimum maintenance, and minimum unit and design/development costs. Orbital mass deliveries will require multiple launches each day, therefore environmental impacts must be considered and held to a minimum. A technology readiness period of approximately 1990 is sufficient to assure the attainment of these goals provided needed funding is made available.

The delivery of cargo and space workers to the construction site requires the development of two different systems, one to handle large cargo deliveries and a smaller system to accommodate crew. The overall scenario of the transportation system is shown on attached Figure 1. Eight major elements comprise the transportation system: Personnel Launch Vehicle (PLV) or Shuttle; Personnel Orbital Transfer Vehicle (POTV); the Heavy Lift Launch Vehicle (HLLV); the Electric Orbital Transfer Vehicle (EOTV); Intra Orbit Transfer Vehicle (IOTV); LEO Support Facility; GEO Support Facility and a Shuttle Derived HLLV (SDHLLV) for supporting the early SPS Demonstration Program. The HLLV and EOTV represent the cargo carriers while the PLV and POTV represent the people carriers. The IOTV is utilized to ferry people and cargo modules over short distances in the vicinity of its station.

In October of 1978, at the request of DoE, NASA established a reference SPS program including the transportation system which could be used in an assessment with other energy systems. The reference system selected depicted the most feasible approach, at the time from the standpoint of technology verification requirements and vehicle performance capability, for accomplishing SPS Program goals.

The reference HLLV concept would be a two stage winged vehicle, either tandem or parallel burn, which has a payload capability of .25M to 1.0M pounds to a 485 Km, 31.6 degree orbit. The reference concept for the EOTV utilizes silicon cells at CR = 1.0 or gallium/arsenide cells at CR = 2.0, generating approximately 335 MW of d.c. power for the Argon-Ion thrusters, in transferring approximately 5.0 M Kg of cargo from LEO to GEO. The personnel carriers are the PLV, from ground-to-LEO, and the POTV, from LEO-to-GEO. The 30-year SPS construction period requires up to 155 POTV flights, 159 PLV flights, 27 EOTV flights, and 722 HLLV flights in a calendar year.

These vehicles are representative of a system which can support the development of the Satellite Power System. Future studies of SPS and its transportation system will continue to investigate new ideas and incorporate new technological developments to arrive at a system best suited to meet the SPS program requirements.

SPS SPACE TRANSPORTATION SCENARIO

195

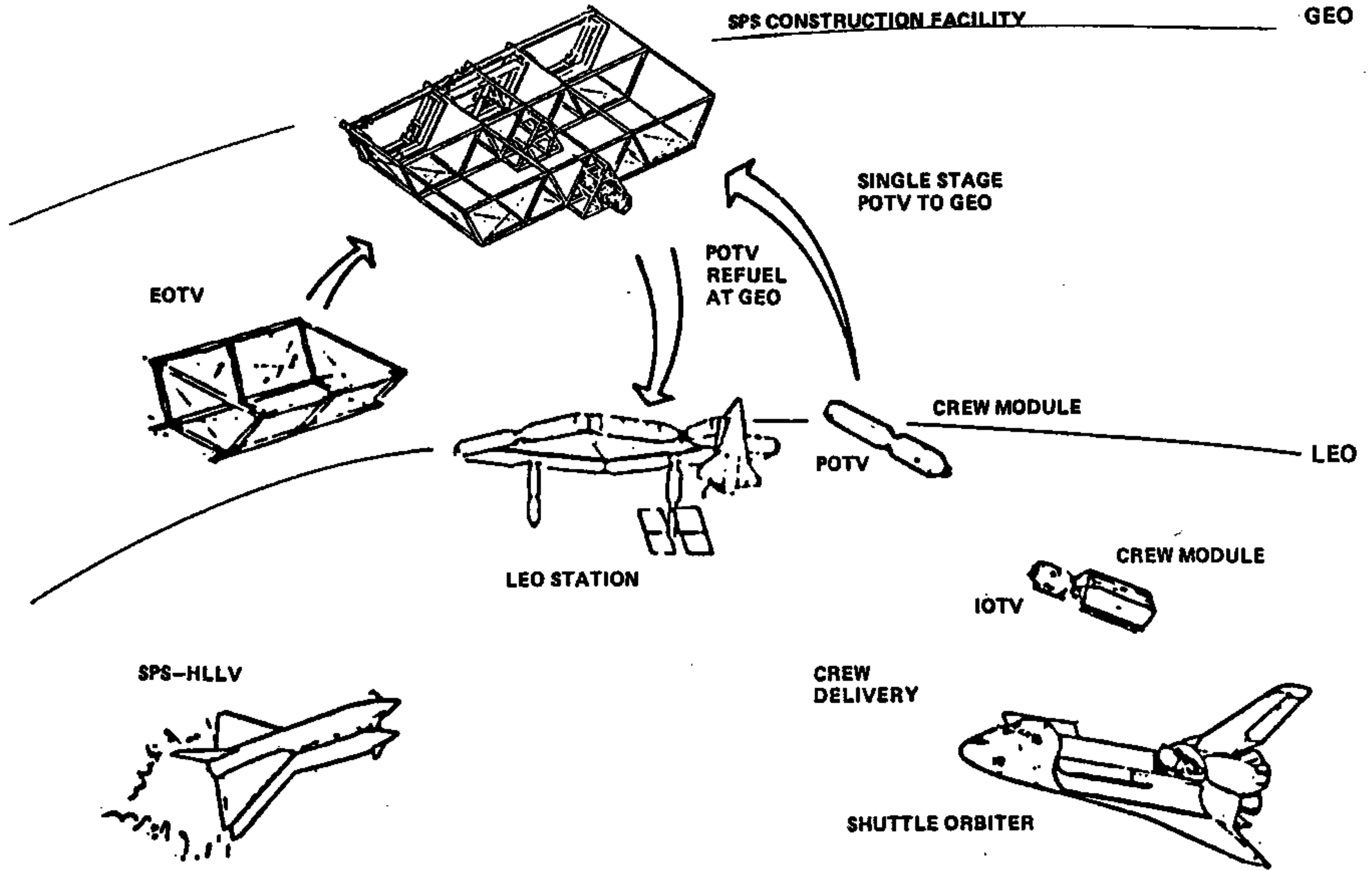

MINIMUM COST CRITERIA FOR SPS TRANSPORTATION TO GEO

Dietrich E. KOELLE, MBB Space Division, Ottobrunn/Germany

The transportation of 50 000 tons (Mg) mass to GEO — as presently estimated for a 5 GW SPS — poses a great challenge to system design and technology, especially however to economic optimization.

Required is a heavy cargo launch vehicle with more than 200 Mg payload in geosync. orbit (GEO), requiring up to some 250 launches for one SPS.

A cost-optimized vehicle of this size seems to be able to realize a range of 50 to 150 \$/kg (1980) specific transportation cost to GEO. This is more than two orders of magnitude lower than the Space Shuttle plus IUS (23 000 \$/kg).

However, the range indicated means 2 to 6 Billion \$ launch cost for one 5 GW SPS, or about one third up to the same amount as the SPS space segment will cost.

For this reason, a strict application of cost optimization has to be applied in vehicle design and not only a performance optimization as in the past.

For a minimum cost heavy cargo launch vehicle the following ground rules can be established:

- (1) **FULLY REUSABLE:** The launch vehicle system shall not comprise any expendable components; the goal is 50 to 100 re-uses with minimum refurbishment.
- (2) **UNMANNED:** For heavy cargo transportation man is not required. The pressurized cabin, the life support and safety systems are a payload penalty and increase cost.
- (3) **TECHNICAL SIMPLICITY:** Minimum technical complexity is required in order to limit development, fabrication and operations cost. This means minimum number of stages and system interfaces, no deployable tanks or boosters. Performance (payload) must be achieved by adequate sizing instead of increasing technical complexity.
- (4) **OPERATIONS SIMPLICITY:** Operations cost represent the largest cost share in case of fully reusable vehicles. Therefore, the design must take into account minimum launch, recovery and refurbishment effort.

These ground rules can be applied to the vehicle design alternatives shown in FIG. 1:

Winged vehicles are excluded because they need a flight crew and the associated equipment. This certainly decreases the payload and increases cost. Because of the lower structural efficiency only two-stage systems can be considered.

In case of unmanned ballistic vehicles a single stage system to LEO (SSTO) is feasible, however, with a lower payload than two-stage or 1 1/2-stage systems. The latter need recovery of tanks or boosters, increasing system complexity and operations cost. Two-stage systems — either to LEO or into LEO/GEO transfer orbit have a suborbital first stage. This means that the vehicle has to be recovered down-

range in the Atlantic and brought back by ship to the launch site.

The direct injection into GEO/LEO transfer orbit is unfavorable because either an expendable kick stage is required or a third stage which has re-entry and landing capability of its own.

The most simple solution both technically and from the operations standpoint seems to be the SSTO + OTV version. For verification a performance and cost analysis was performed for three types of vehicles, as shown in FIG. 2. (This is a model comparison only for concept evaluation).

The detailed cost model includes refurbishment cost, direct operations cost (such as system management, on-launch ops., launch and mission control, propellants, recovery and transportation) as well as the indirect operations cost (launch site administration, support and facilities).

Beside the vehicle system concept the vehicle size or payload capability has a major influence on transportation cost. FIG. 3 illustrates the interrelation between vehicle GEO payload capability, number of launches per year and total construction period for a 5 GW SPS.

The cost impact both of vehicle size and launch rate is shown in FIG. 4. The specific cost are reduced with increasing annual launch rate, however, increasing vehicle size is more effective for cost reduction above some 50 launches per year.

Larger vehicles require higher development investments but the difference can be amortized already after the launch of one SPS because the transportation may be reduced by a factor of two.

The economics of large size vehicles again confirm a ballistic-type system providing a large payload volume. Larger pieces of the SPS reduce the orbital assembly effort and the related cost.

However, even if the larger size means better economics, one certainly would not go straight to the final vehicle but an intermediate size in the 100 to 200 Mg GEO payload class, or 4 000 to 6 000 Mg launch mass (GLOW). This size of vehicle could also be used for nuclear waste disposal into space.

The equatorial ESA launch site Kourou (French Guyana) would probably be a good option for an international launch site, both for SPS and nuclear waste transportation. Environmental restrictions at the Kennedy Space Center as well as the 8 — 10 % higher payload recommend this.

Basically a policy decision is required for the next generation of launch vehicles whether the US will make a joint effort with Europe or go alone (may be in one direction and Europe in another).

LAUNCH VEHICLE CONCEPT SCHEMATIC

FIG. 1

Reusable Cargo Launch Vehicle System Alternatives from Earth to Geosynchronous Orbit

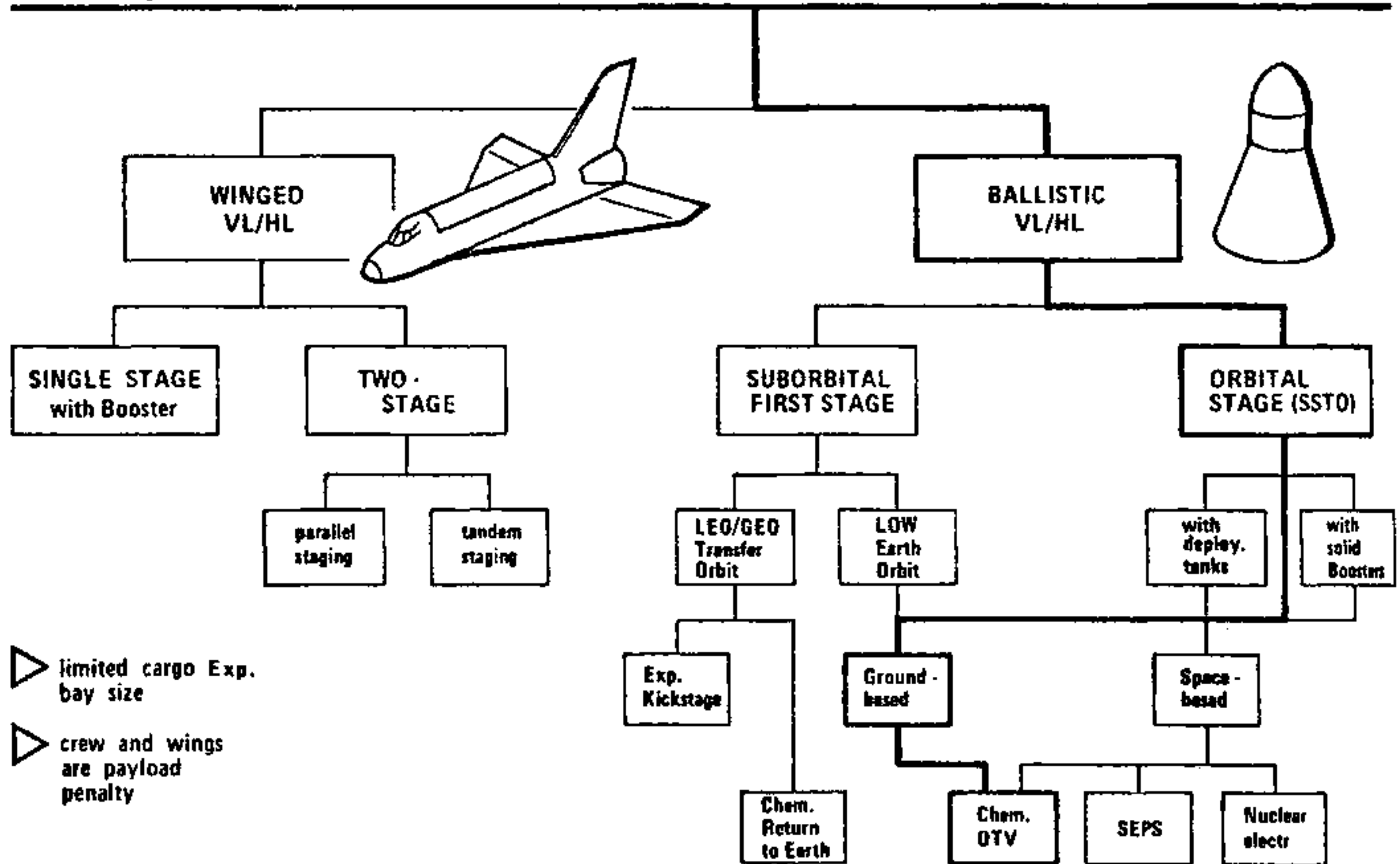

- ▷ limited cargo Exp. bay size
- ▷ crew and wings are payload penalty

COST COMPARISON

FIG. 2

of three alternative ballistic launch vehicle systems with 30 Mg GEO Payload and a launch rate of 100 LpA

	A	B	C
LAUNCH COST	SSTO + OTV	TWO-STAGE VEHICLE WITH DIRECT INJECTION AND KICK STAGE	TWO-STAGE VEHICLE TO LEO PLUS OTV
LAUNCH MASS (GLOW)	1280 Mg	1080 Mg	770 Mg
PAYLOAD RATIO (PL/GLW)	2.3 %	2.8 %	3.9 %
DEVELOPMENT COST	73 000 MY = 7.3 B. \$ (81)	111 000 MY = 11.1 B. \$ (81)	104 000 MY = 10.4 B. \$ (81)
MANUFACTURING COST (1 SYSTEM WITH 100 RE-USES)	1785 MY	2040 MY + 4900 MY FOR 100 KICK STAGES	1700 MY
OPERATIONS COST (100 FLIGHTS)	6340 MY	12 695 MY	12 675 MY
SPECIFIC COST	3.6 $\frac{MY}{Mg}$	6.5 $\frac{MY}{Mg}$	4.8 $\frac{MY}{Mg}$

LAUNCH VEHICLE SIZING

FIG. 3

(GEO payload) and total number of launches for a 5 GW SPS with 50 Gg total mass

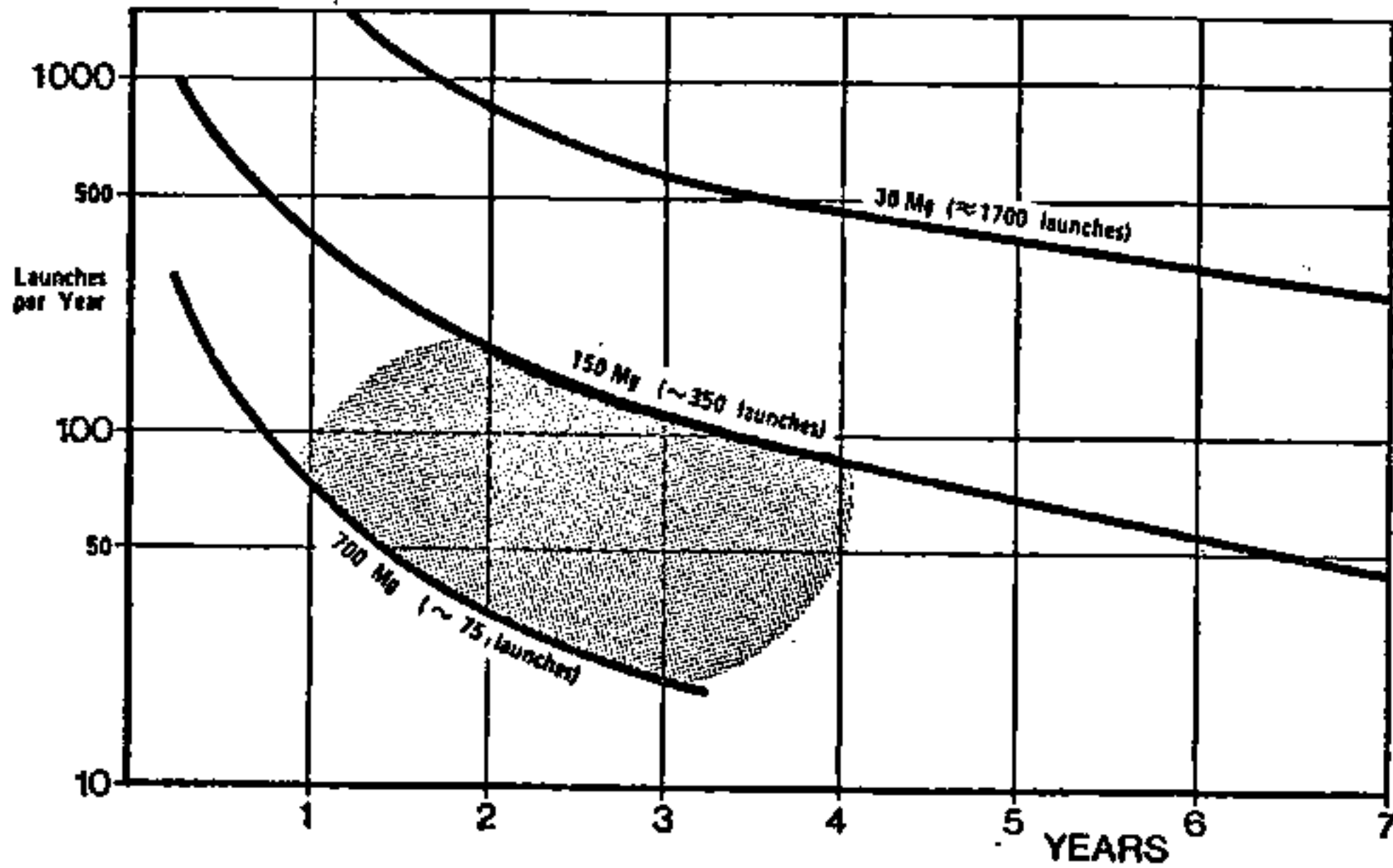

SPECIFIC TRANSPORTATION COST

FIG. 4

to geosynchronous Earth orbit (GEO) vs. annual cargo volume and launch vehicle capability (SSTO + OTV)

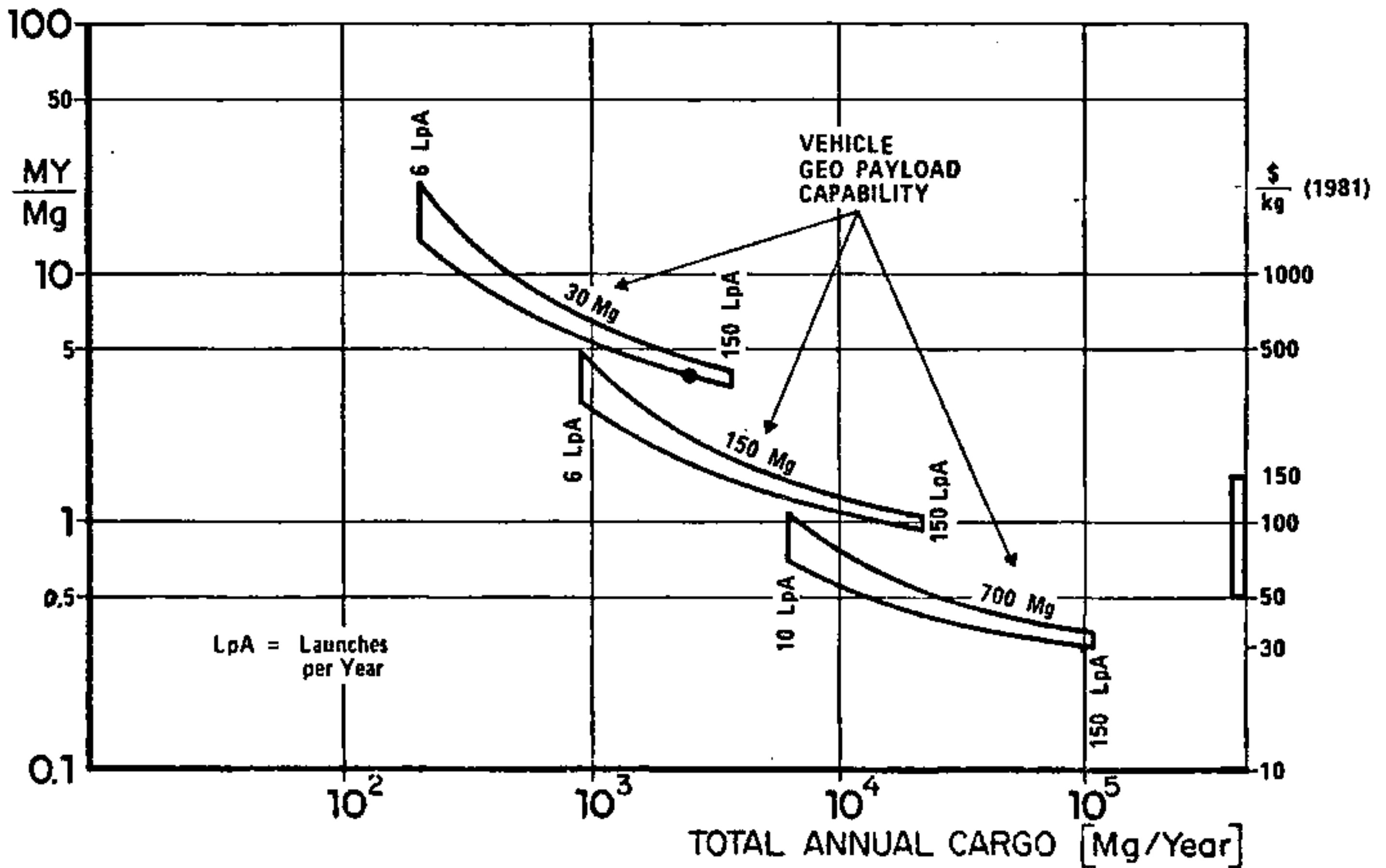

EARTH-TO-ORBIT TRANSPORTATION FOR SOLAR POWER SATELLITES

Gordon R. Woodcock
Boeing Aerospace Company
and
Gerald Hanley
Rockwell International

Transportation of solar power satellites to space will require cargo transport capability much greater than any other space technology application thus far investigated. The cost of space transportation operations represents, in the reference SPS system, more than one fourth of the total production cost of the SPS's, even though the unit cost in dollars per kilogram is projected to be much less than that presently foreseen for the Space Shuttle. Three-fourths of the cost is contributed by the launch systems (including launches delivering orbit transfer propellant) with the remainder contributed by orbit transfer systems. Further, developing the vehicles required and acquiring the operational vehicle fleet is the largest single element of SPS nonrecurring cost. Consequently, the design approach for these vehicles and their ability to achieve the projected cost is of great importance to the economic practicality of solar power satellites; commensurate importance has been given to the concept definition for space transportation in the SPS Systems Definition studies.

The history of SPS launch vehicle evolution is shown in Figure 1. Early studies of SPS launch vehicles examined ballistic systems shaped like large Apollo spacecraft; these were to return to Earth engines-first by aerobraking and land at sea for recovery by ship. Single-stage and two-stage options were examined. The performance of the two-stage systems was enough better to more than offset their greater operational complexity.

Later, comparison of winged and ballistic launch vehicles concluded that the winged systems were preferred. Although more expensive per unit, shorter turnaround time permits a smaller vehicle fleet, effecting overall savings. This trade resulted in selection of the two-stage winged vehicle now represented as the SPS reference launch vehicle. The size of the vehicle was somewhat arbitrary. The only specific consideration was selection of a payload bay large enough to accommodate a fully-assembled electrical slip ring, 16 meters in diameter. The payload capability of the reference vehicle was estimated as 420 gross tonnes, with an effective net payload of about 360 to 380 tonnes after accounting for mass of payload pallets, propellant containers, and similar factors.

This vehicle design was based on "normal" technology growth. The second stage engine was the Space Shuttle Main Engine (SSME) and the first stage engine was assumed to be a new-development gas-generator oxygen-hydrocarbon engine. Modest use of composite materials in the dry structure was assumed, limited to areas not subjected to high temperatures as a result of aerodynamic or plume heating. The booster is a heat-sink design for reentry heating; the orbiter assumes an advanced Shuttle-type RSI, with improved durability and serviceability. Subsystems masses were based on extrapolations from the Shuttle subsystems. The reference vehicle is shown in Figure 2. Figure 3 presents a mass distribution, and Figure 4 shows the corresponding first unit cost. Figure 5 shows the schedule estimates for vehicle turnaround upon which the fleet size is based.

Alternative vehicle designs have been created by other studies. The most important are (1) A parallel-burn, crossfeed configuration developed by Rockwell International on their SPS studies; (2) A single-stage-to-orbit airbreathing/rocket runway takeoff vehicle concept developed by Rockwell, and (3) A smaller HLLV concept developed by Boeing. The parallel-burn configuration yields about 10% improvement in payload capability at a given liftoff mass, but involves increased operational complexity. An adequate tradeoff to select between series and parallel burn has not been conducted. The airbreather concept was representative of vehicle designs that might be attainable with highly advanced propulsion and structures technology.

The smaller HLLV was analyzed to compare the non-recurring cost benefits of a less challenging development with the recurring cost increases expected due to losses in efficiency associated with smaller vehicle size. The vehicle payload bay size was selected to be adequate to accommodate the SPS transmitter subarrays fully assembled. This required a square cross-section of 11 meters; the length was set at 14 meters. Parametric investigations led to a gross lift capability requirement of 120 metric tonnes. The resulting vehicle design is compared with the Shuttle, the Saturn V, and the reference SPS HLLV in Figure 7. Mass estimating revised the parametrically-estimated lift capability to 125 tonnes. Costs were derived by the Boeing Parametric Cost Model (PCM), and cost per flight was estimated by procedures consistent with those used for the reference system. Operational effects of the smaller payload bay were analyzed to develop a total delta cost understanding. Delta environmental effects were also estimated. The end result was that a nonrecurring savings of at least five billion dollars was obtained with a recurring cost penalty of 3% per SPS. Further, the environmental benefits of the small vehicle: reduced sonic overpressure, noise, potential blast effect in the event of an accident, and less modification of the Cape Canaveral area to accommodate launch pads, were deemed more important than the slight increase in upper atmosphere propellant deposition. As a result of these considerations, it is recommended that the small HLLV be adopted as the SPS reference launch system.

Important areas remaining to be investigated include: (1) Comparison and selection between series and parallel burn; (2) Configuration development to a sufficient level of detail to permit specific facilities and operations systems definition; and (3) Development of an evolutionary strategy for evolving from the present Shuttle system, through Shuttle improvements or Shuttle-based interim HLLV capability, to the SPS operational configuration. Considerations include engine and subsystem commonality and evolution as well as launch capability to support SPS development requirements as well as other space applications needs.

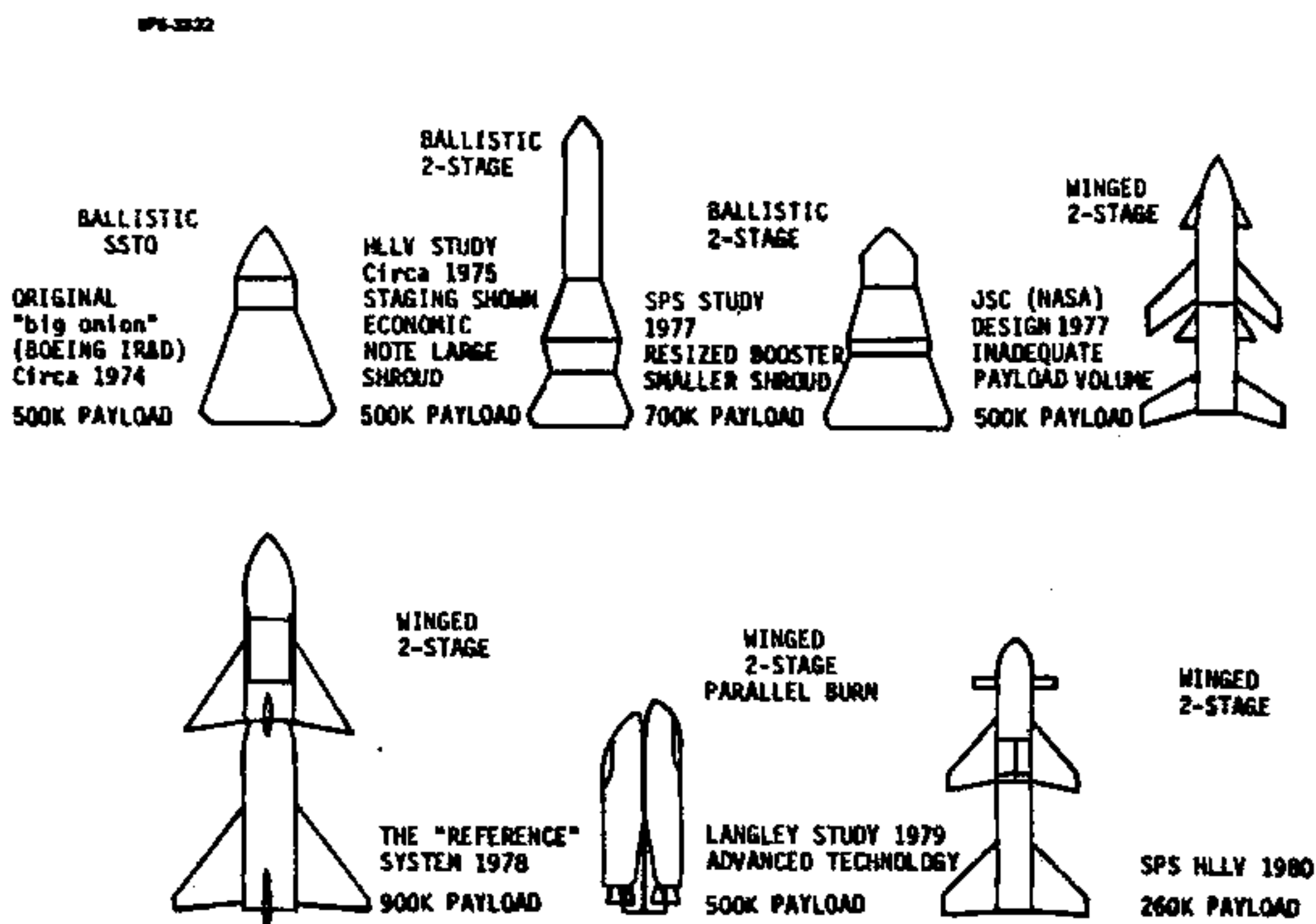

Figure 1- SPS LAUNCH VEHICLE CONCEPT EVOLUTION

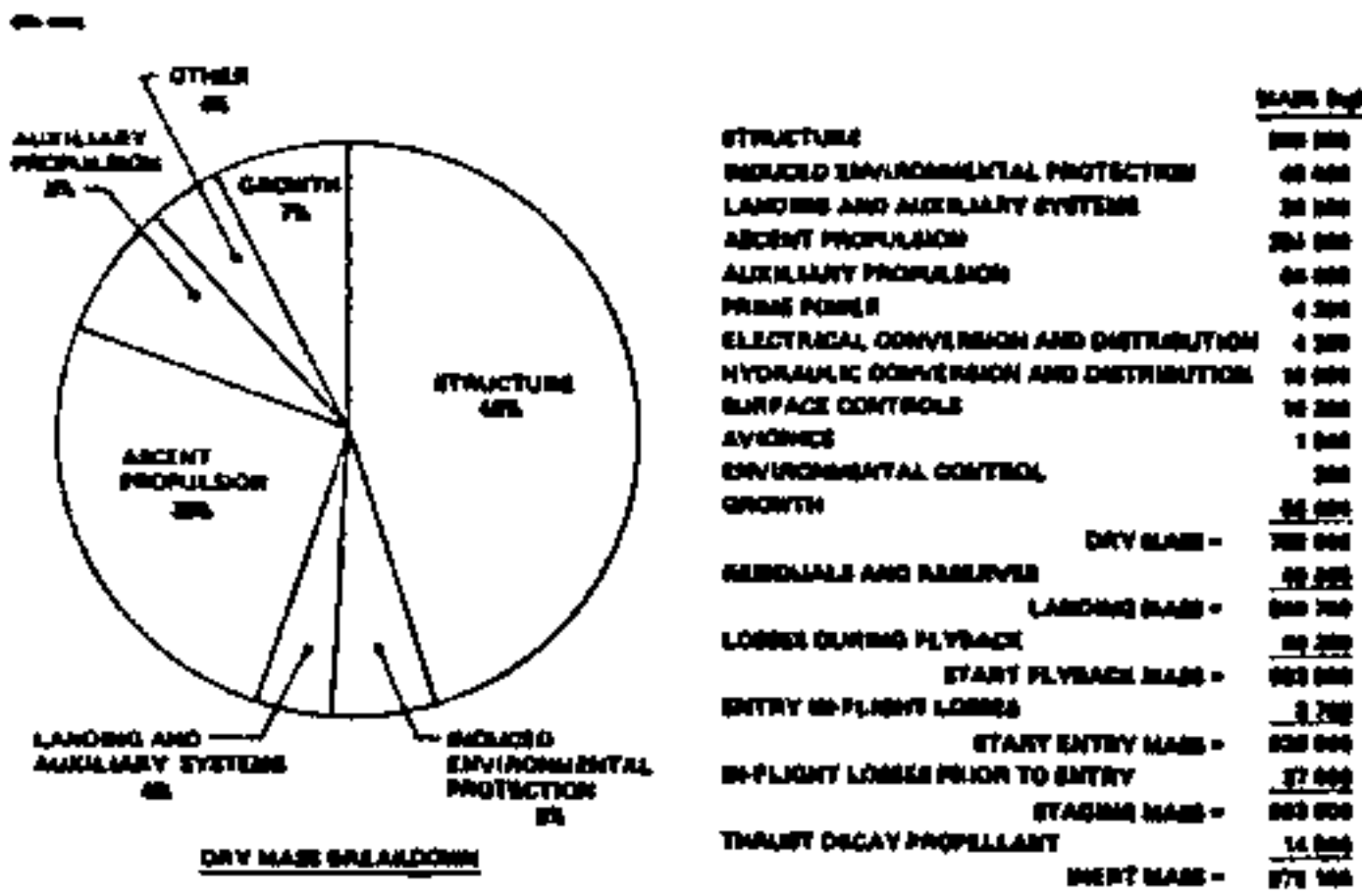

Figure 2- BOOSTER MASS STATEMENT

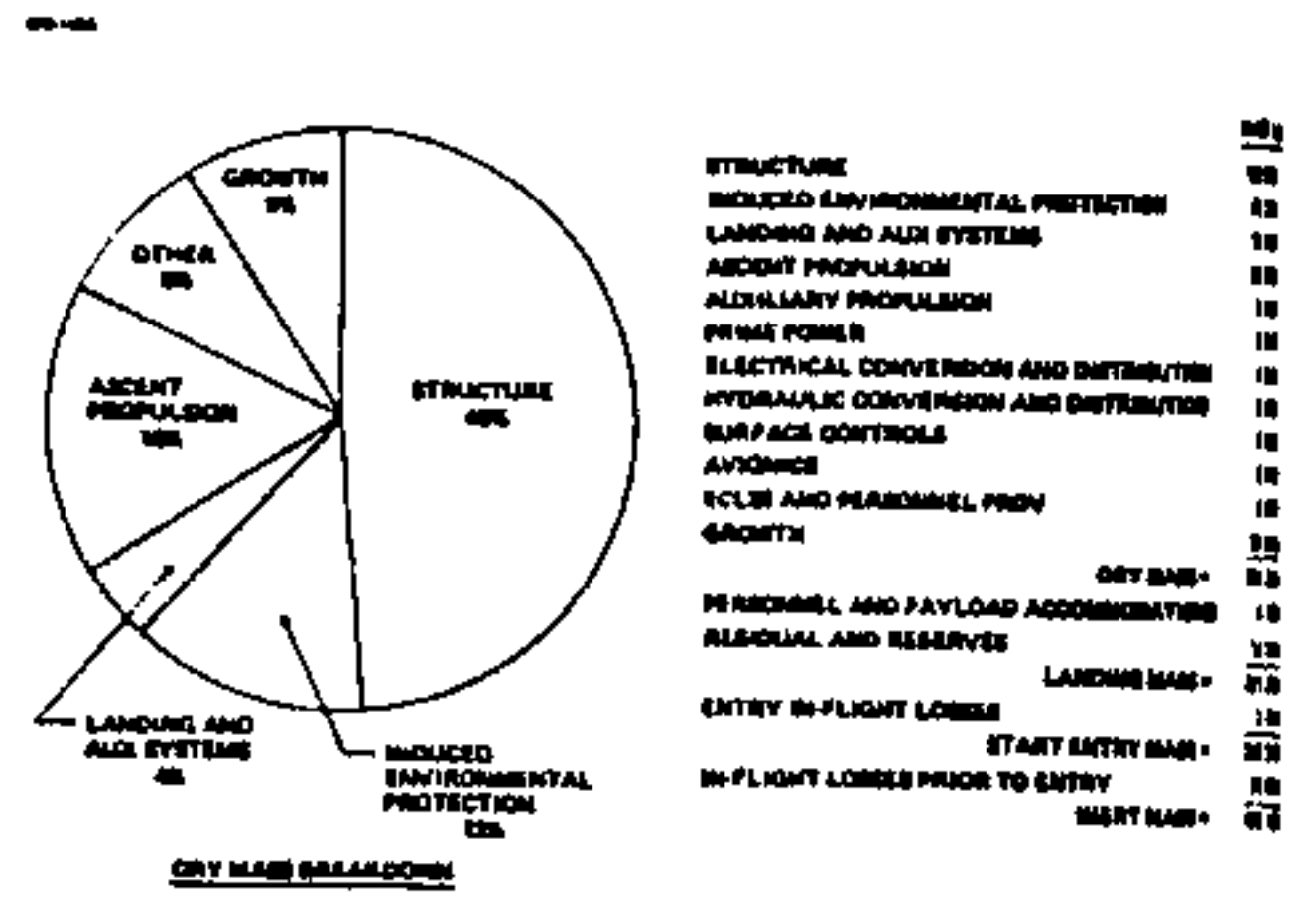

Figure 3- ORBITER MASS STATEMENT

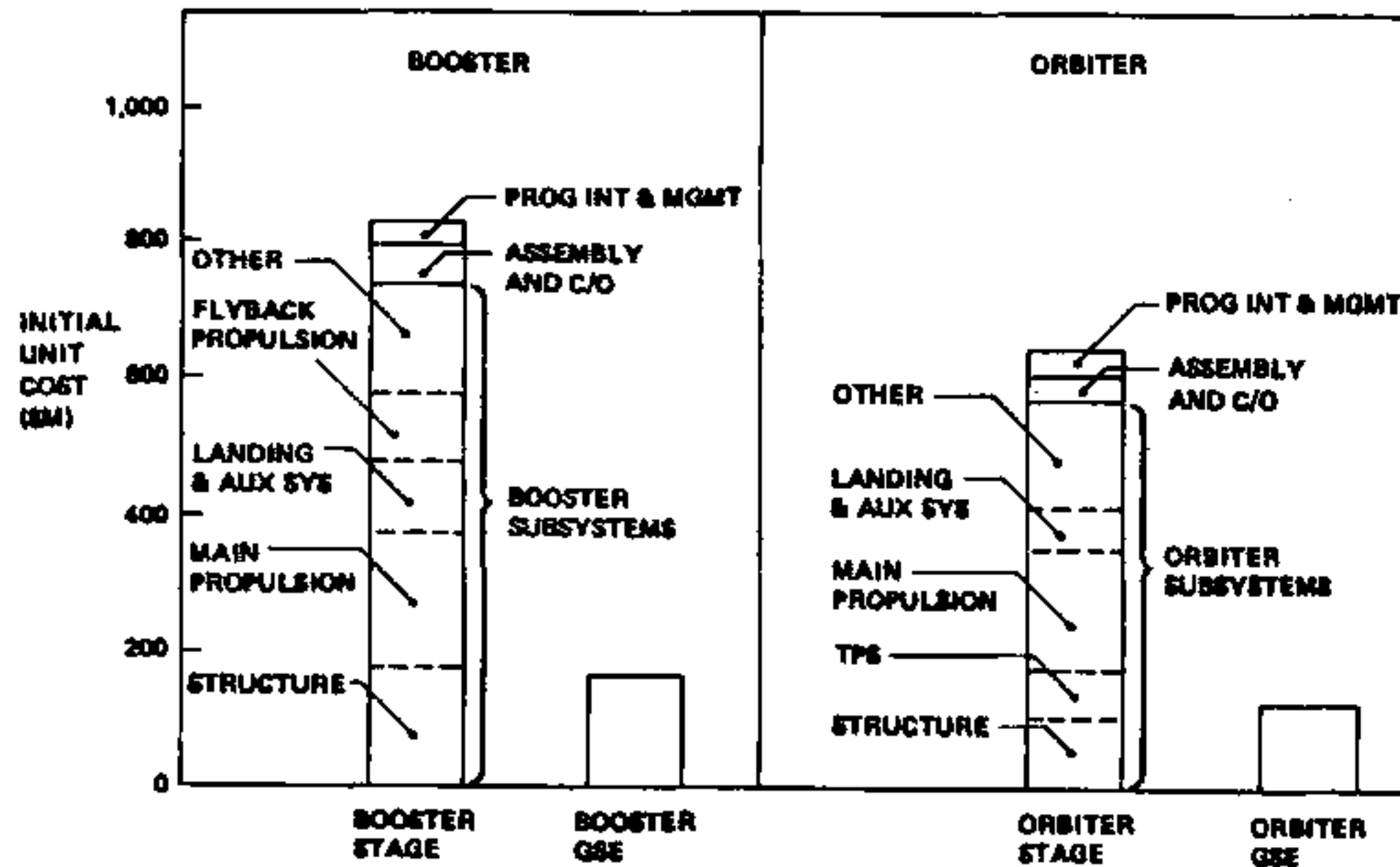

Figure 4- SPS LAUNCH VEHICLE PRODUCTION COST

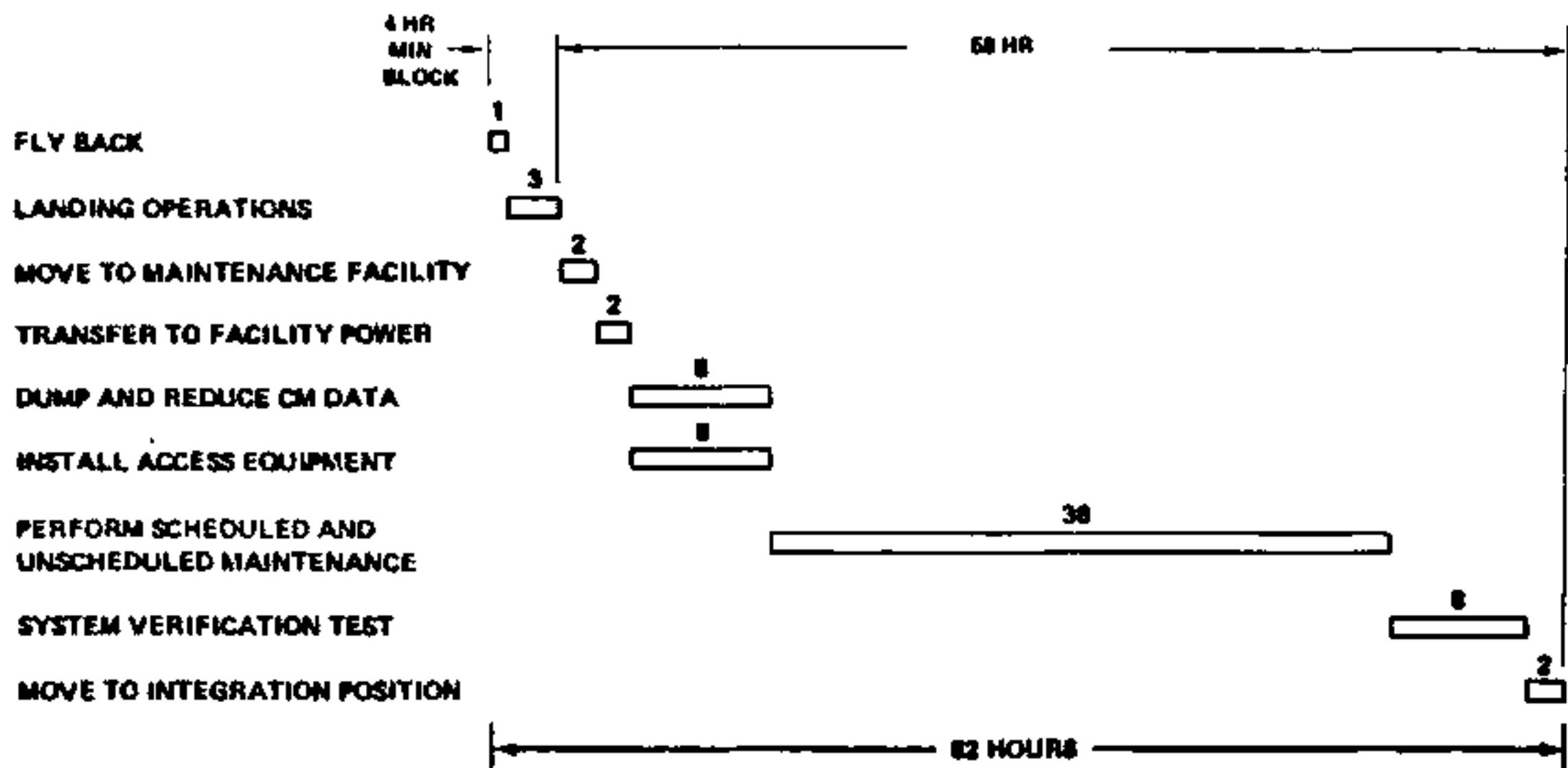

Figure 5- HLLV BOOSTER PROCESSING TIMELINES

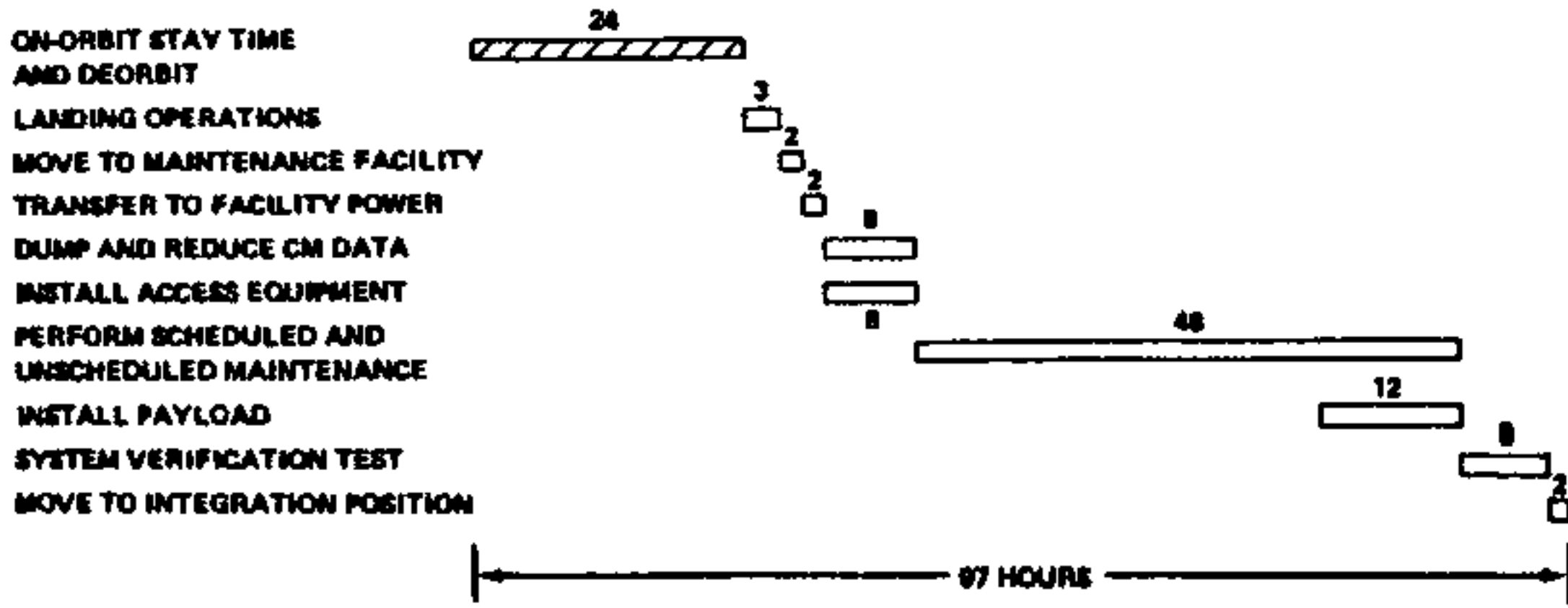

Figure 6- ORBITER PROCESSING TIMELINES

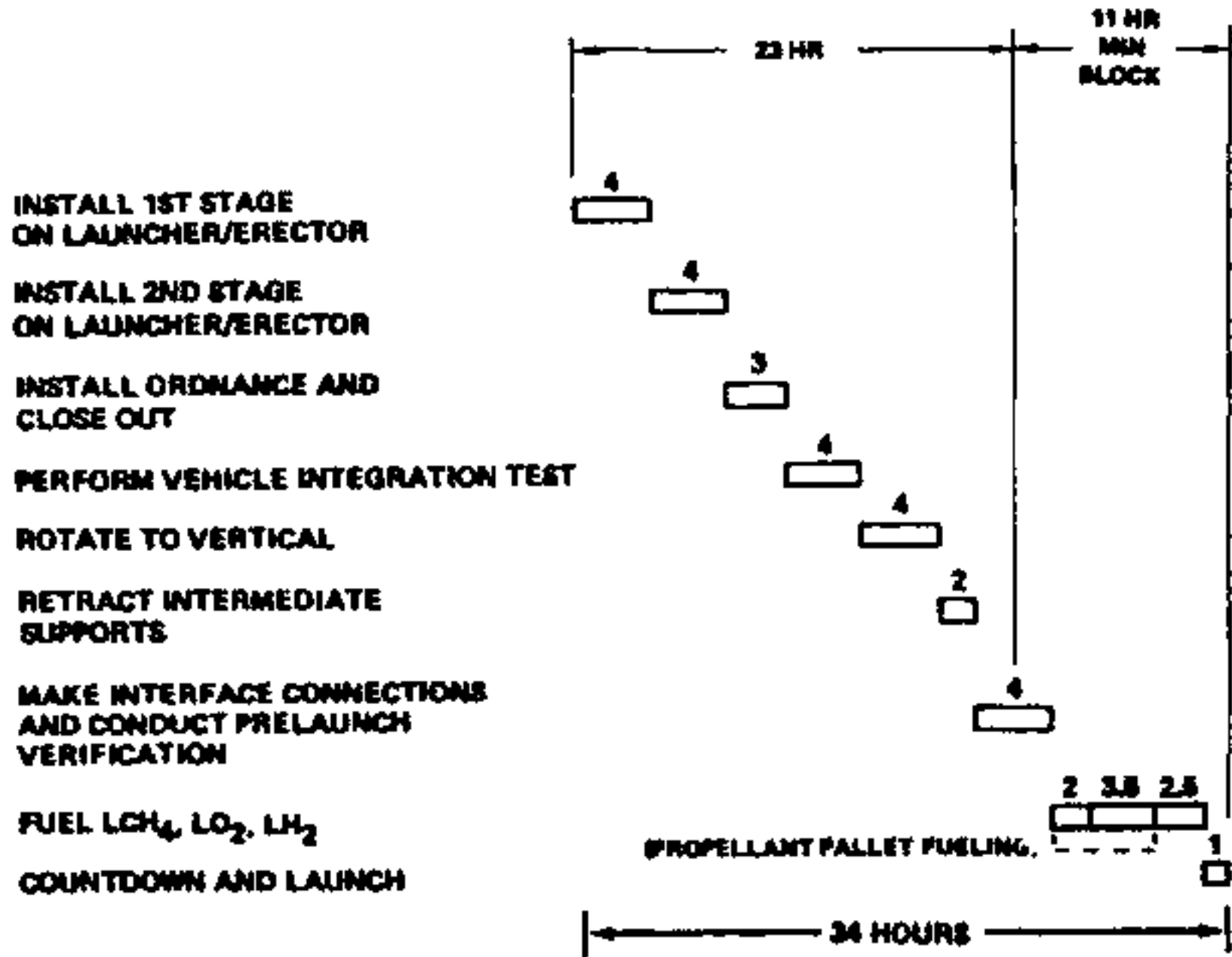

Figure 7- INTEGRATED VEHICLE OPERATIONS TIMELINES

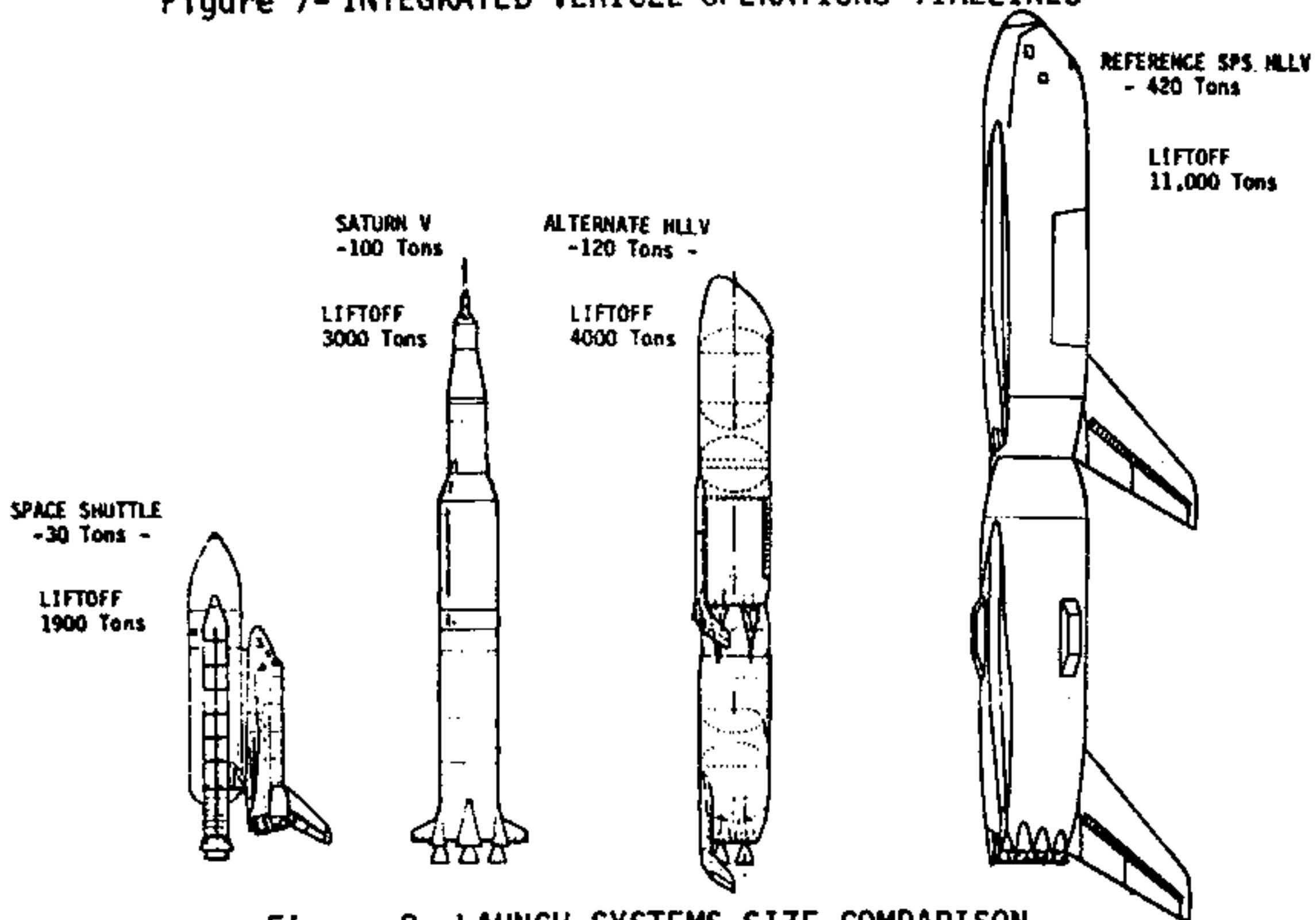

Figure 8- LAUNCH SYSTEMS SIZE COMPARISON

ORBIT-TO-ORBIT TRANSPORTATION

by R.P. Bergeron

Rockwell International, Space Operations and Satellite Systems Division

The Satellite Power System (SPS) program necessitates the transfer of significant cargo mass and personnel from low earth orbit (LEO) to geosynchronous earth orbit (GEO). The SPS transportation costs represent a major portion of program funding requirements and therefore require a most cost-effective approach toward LEO-GEO transfer.

Orbital transfer vehicle propulsion options include both chemical (COTV) and electrical (EOTV) options. The chemical options evaluated included single- and two-stage liquid oxygen/liquid hydrogen propulsive elements. The electric propulsion options considered alternate power sources (i.e., silicon or gallium aluminum arsenide solar arrays), propellant type (mercury, argon, cesium, etc.), low and high current density thrusters, methods of maintaining attitude hold during periods of shadow (chemical or electric), and programmatic impact of LEO-GEO trip time. The proposed EOTV construction method is similar to that of the SPS and, by the addition of a transmitting antenna, may serve as a demonstration or precursor satellite option.

The results of the studies to date have led to the tentative selection of a single-stage COTV for crew and priority cargo transfer (the COTV is refueled in GEO for return to LEO). The size of the propulsive element is dictated by the estimated crew transfer requirement. An EOTV concept is favored for cargo transfer because of the more favorable orbital burden factor over chemical systems. Although it is highly desirable to maintain a maximum degree of commonality between the SPS and EOTV, the gallium arsenide solar array is favored over the silicon array because of its self-annealing characteristics of radiation damage encountered during multiple transitions through the Van Allen radiation belt.

Transportation system operations are depicted in Figure 1. A heavy-lift launch vehicle (HLLV) delivers cargo and propellants to LEO, which are transferred to a dedicated EOTV by means of an intra-orbit transfer vehicle (IOTV) for subsequent transfer to GEO.

The Space Shuttle is used for crew transfer from earth to LEO. At the LEO base, the crew module is removed from the Shuttle cargo bay and mated to a COTV for transfer for GEO. Upon arrival at GEO, the SPS construction cargo is transferred from the EOTV to the SPS construction base by IOTV. The COTV with crew module docks to the construction base to effect crew transfer and COTV refueling for return flight to LEO. Crew consumables and resupply propellants are transported to GEO by the EOTV.

Transportation requirements are dominated by the vast quantity of materials to be transported to LEO and GEO (Figure 2). The average annual mass to orbit is in excess of 100 million kilograms, with over 100 personnel transfer flights per year.

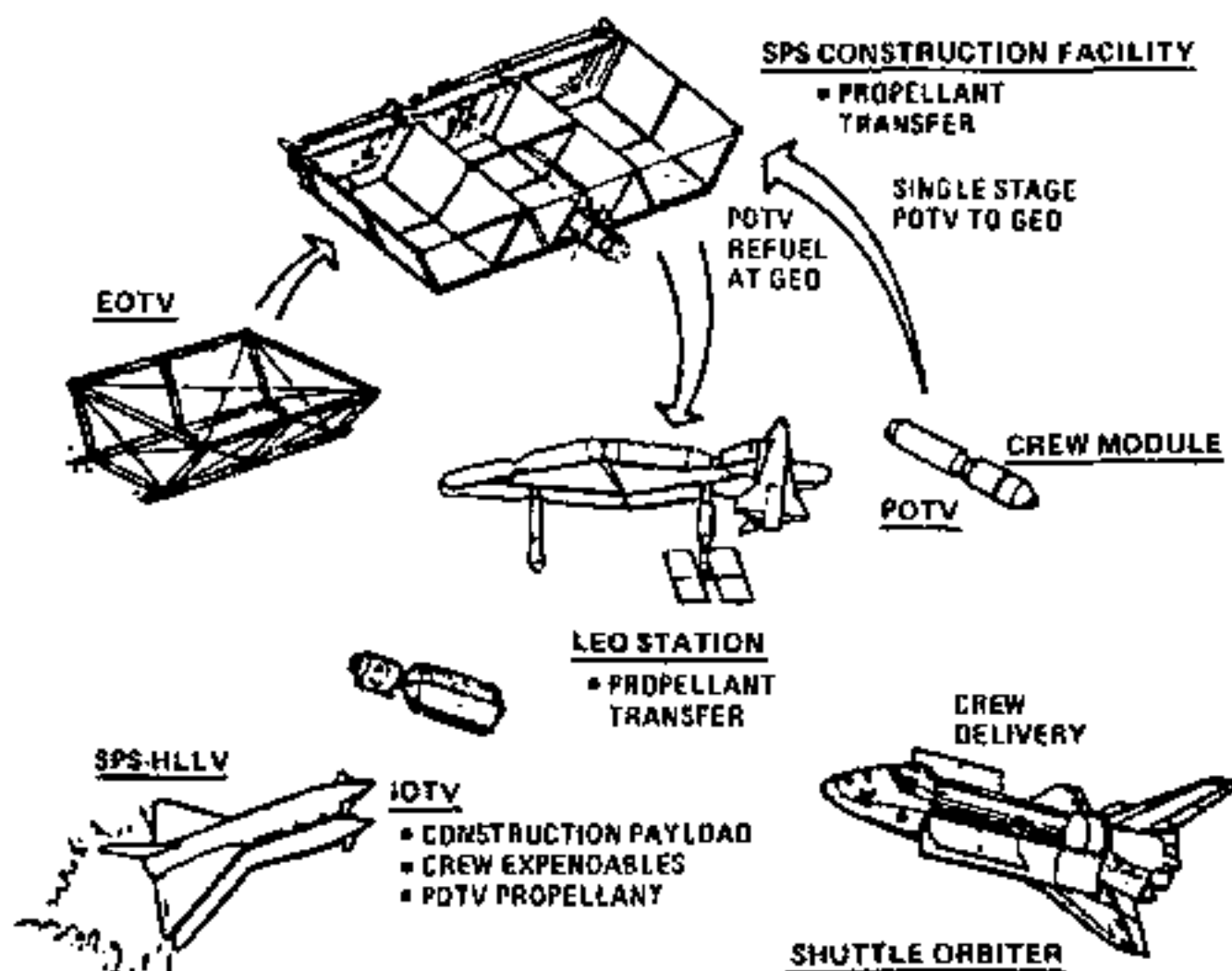

Figure 1. Transportation System Orbital Operations

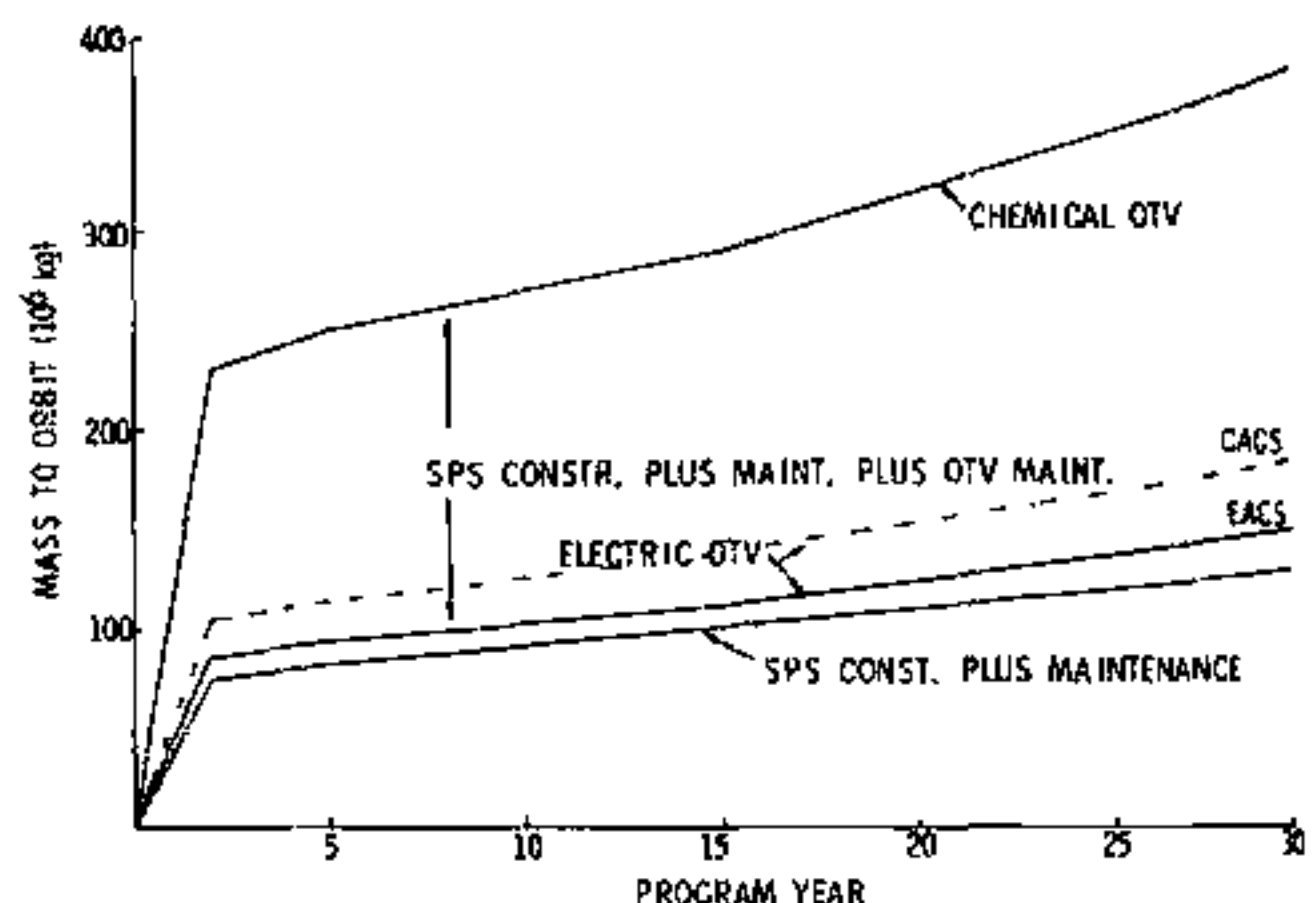

Figure 2. Orbital Mass Flow Requirement

The personnel orbital transfer vehicle (POTV) uses a single-stage chemical propulsive element (COTV) to transport the crew module and its crew and passengers from LEO to GEO and return (Figure 3). Although significant propellant savings occur with this approach, as compared to a two-stage concept, the percentage of total mass is small when compared with satellite construction mass. However, the major impact is realized in the smaller propulsive stage size and the overall reduction in orbital operations requirements.

Individual propellant tanks are indicated for the LO_2 and LH_2 in this configuration because of uncertainties at this time in attitude control requirements. With further study, it may be advantageous to provide a common bulkhead tank as in the case of the Saturn S-II stage and locate the ACS at the mating station of the POTV and personnel module or in the aft engine compartments—space permitting.

The POTV utilizes two advanced space engines (ASE), which are similar in operation to the Space Shuttle main engine. The engine is of high performance with a staged combustion cycle capable of idle-mode operation. The engine employs autogeneous pressurization and low inlet NPSH operation. A two-position nozzle is used to minimize packaging length requirements.

Since the POTV concept utilizes an on-orbit maintenance/refueling approach, an on-board system capable of identifying/correcting potential subsystem problems to minimize/eliminate on-orbit checkout operations is postulated.

The EOTV concept (Figure 4) is based on the same construction principles of the Rockwell reference satellite. The commonality of the structural configuration and construction processes with the satellite design is evident. The structural bay width of 700 m (solar array width of 650 m) is the same as that of the satellite. The structural bay length is reduced from 800 to 750 m for compatibility with the lower voltage requirement of the EOTV.

The solar array voltage must be as high as possible to reduce wiring weight penalties and to provide high thruster performance, yet power loss by current leakage through the surrounding plasma must be minimized. At the proposed LEO staging base, with very large solar arrays and high efficiency cells, an upper voltage limit of 2000 volts is postulated. These considerations lead to the selection of a two-bay configuration with structural dimensions of 700 m x 1500 m (solar blanket size 650 m x 1400 m) with a total power output of 309 mw (includes 6% line losses).

Primary assumptions in EOTV sizing are given in Table 1. The solar array weights are scaled from satellite weights and are summarized in Table 2.

Since GaAIAs solar cells are employed in this concept with a concentration ratio of 2 on the solar cell blanket, the resulting cell operating temperature of $125^\circ C$ allows continuous self-annealing of the solar cells during transit through the Van Allen radiation belt.

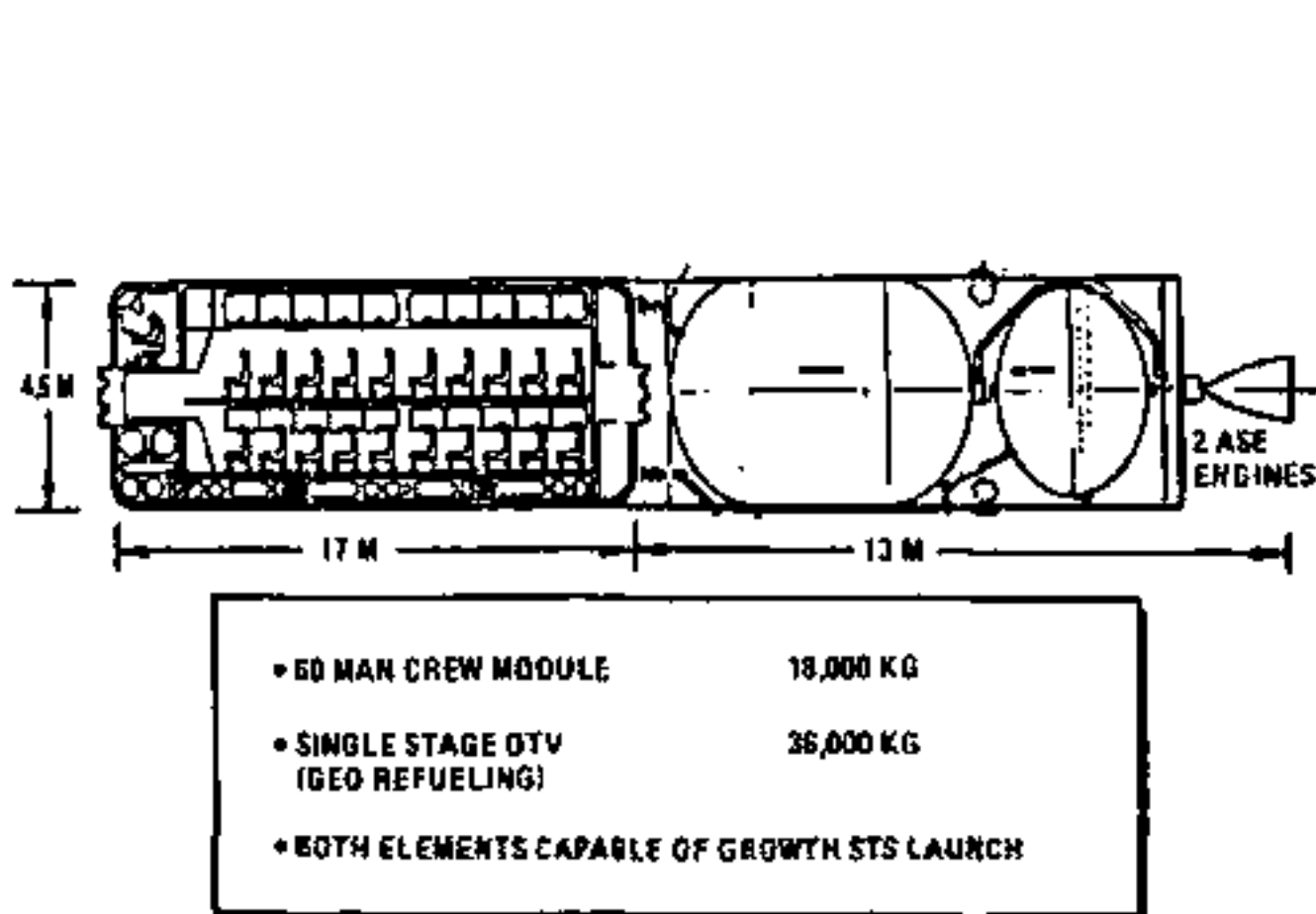

Figure 3. Personnel Orbital Transfer Vehicle

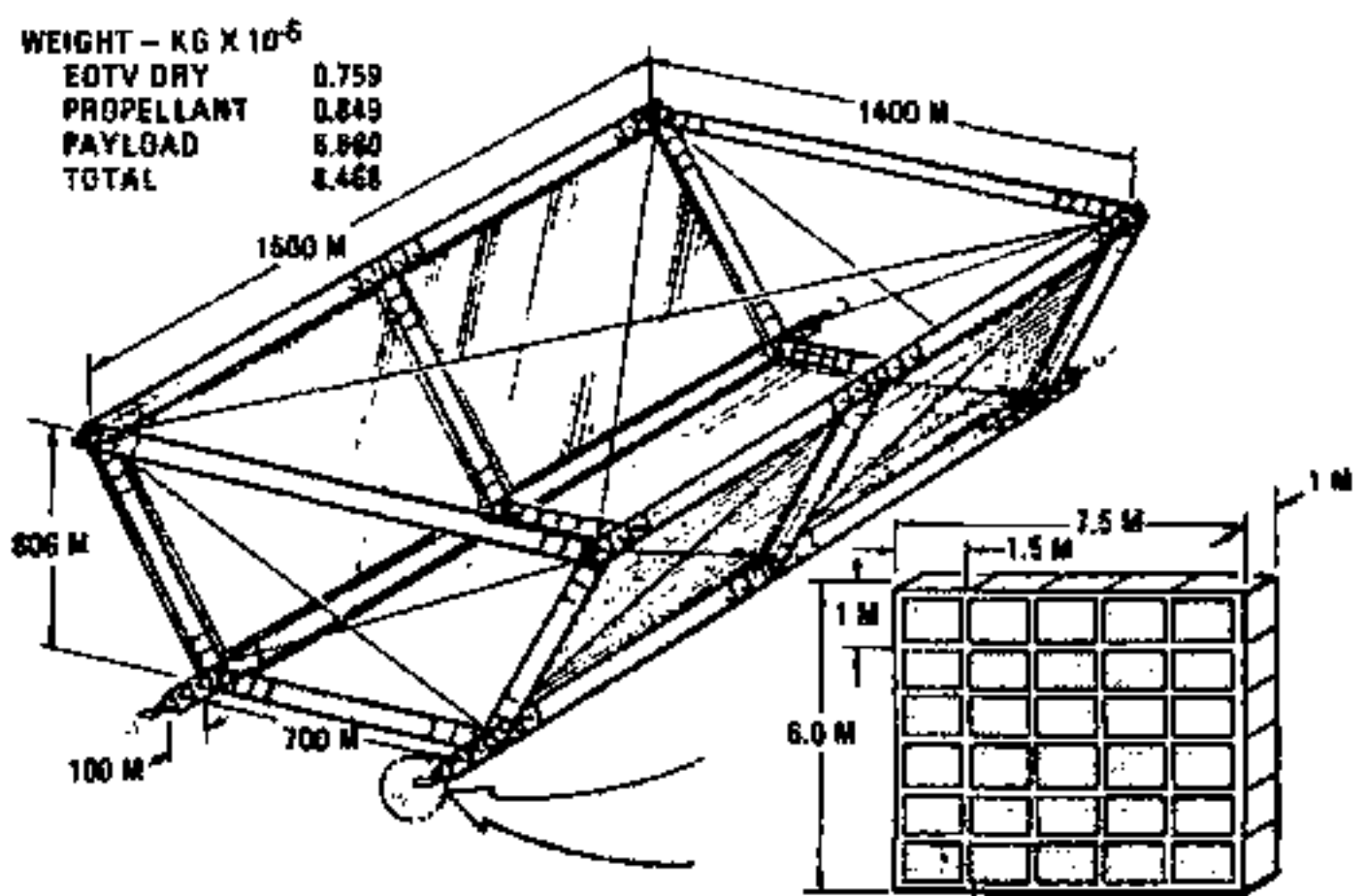

Figure Electric Orbital Transfer Vehicle

Table 1. EOTV Sizing Assumptions

Item	Characteristics
LEO altitude	487 km, 31.6° incl.
Orientation	Solar inertial
Launch opportunity	Anytime of year
ΔV requirement	5700 m/sec
Solar inertial attitude hold	During occultation only
Plume clearance	50°
Number of thrusters	Minimize
Spare thrusters (failures/thrust differential)	20%
Performance losses during thrusting	5%
ACS power requirement	Max occultation period
ACS propellant requirements	100% duty cycle
Weight growth allowance	25%

Table 2. EOTV Solar Array Weight Summary

Item	Weight (10 ⁻⁶ kg)
Structure	0.051
Primary	(0.026)
Secondary	(0.025)
Mechanisms	0.004
Concentrators	0.033
Solar panels	0.229
Power distribution and controls	0.011
Maintenance provisions	0.003
Information management	0.002
Total	0.333

An all-electric thruster system was selected for attitude control during occultation periods to minimize propellant weight requirements (Figure 1). The power storage system was sized to accommodate maximum gravity gradient torques and occultation periods.

An excess of thrusters is included in each array to provide for potential failures, to permit higher thrust from active arrays when thrusting is limited or precluded from a specific array due to potential thruster exhaust impingement on the solar array, and to provide thrust differential as required for thrust vector/attitude control.

Having established the solar array operating voltage, the maximum thruster screen grid voltage is established, which in turn fixes propellant ion specific impulse. To assure adequate grid life for a minimum round-trip capability of approximately 4000 hours, a maximum beam current of 1000 amp/m² was selected. Based on the available power and a desire to maintain reasonable thruster size, the remaining thruster parameters are established. A rectangular thruster configuration (1 m x 1.5 m) is assumed. Primary thruster characteristics are summarized in Table 3.

Conventional power conditioners for ion bombardment thrusters regulate all supplies, serving as an interface between the power source (solar array) and the thrusters. Various direct-drive concepts have been proposed in which the primary (beam power) thruster supply is obtained directly from the solar array power bus. This approach reduces power conditioner mass, power loss, and cost and improves system reliability. Solar cell temperature, efficiency, and output voltage variations will cause acceptable transients in beam voltage during thruster operation.

Based on the individual thruster power requirements and the available array power, 100 thrusters may be operated simultaneously. An additional 20 thrusters are added to provide the required thrust margin. The thrusters are arranged in 4 arrays of 30 thrusters each. The thruster array mass summary is presented in Table 4.

The EOTV performance is based on a 120-day trip time from LEO to GEO (obtained from trade studies). Knowing the propellant consumption rate of the thrusters and the thrusting time, the maximum propellant which can be consumed is determined, which in turn defines the payload capability. The vehicle also is sized to provide for the return to LEO of 10% of the LEO-to-GEO payload. The EOTV weight summary is presented in Table 5.

Since the EOTV solar array utilizes the same configuration, materials, and manufacturing processes as the satellite, common technology requirements are evident. The unique technology requirement is in the primary area of ion engine development. The key requirement is in large size (1.0 m x 1.5 m) high current density (1000 amp/m²) thruster demonstration.

Table 3. Argon Ion Thruster Characteristics

Item	Value
Maximum total voltage (V)	4405
Maximum operating temperature (°K)	1330
Screen grid voltage (V)	1880
Accelerator grid voltage (V)	-2525
Beam current (amp)	1500
Beam power (W)	2.82 x 10 ⁶
Specific impulse (sec)	7963
Thrust (NW)	56.26

Table 4. Thruster Array Mass Summary

Item	Mass (kg)
Thrusters and structure	23,760
Conductors	5,920
Beams and gimbals	2,256
Power processing	1,550
Attitude reference system	1,000
Batteries and charger	154,500
Total	188,986

Table 5. EOTV Mass Summary

Item	Mass (10 ⁻⁶ kg)
Solar array	0.333
Thruster array (4)	0.189
Propellant tanks and distribution	0.085
EOTV (dry)	0.607
Growth (25%)	0.152
EOTV, total	0.759
Propellant	0.849
Main LEO-GEO	(0.655)
Main GEO-LEO	(0.130)
Attitude control	(0.064)
EOTV (wet), total	1.608
Payload	6.860
LEO departure	8.468
GEO arrival	7.789
GEO departure	1.603
LEO arrival	1.469

OFFSHORE SPACE CENTER (Offshore Launch Site)
Donald G. Hervey
Brown & Root Development, Inc.

An Offshore Space Center (OSC) from which space vehicles could be launched into and returned from orbit, is a logical concept for development of the high level of space activity expected in the not too distant future. The OSC provides substantial benefits as a support base and launch site for such a pattern of use. Any activity which requires the development of a heavy launch lift vehicle (HLLV) will benefit by operation from an OSC. Cost, operational, and political advantages make the OSC an attractive concept.

Operating from near the equator provides a twenty percent increase in payload in an ecliptic plan orbit. The offshore site, in international waters, will function as a central location, easily reached by earthbound transportation from worldwide sources of materials which must be launched into space. The remote location in international waters isolates the launch operations (e.g. noise) from population centers and from some other major potential environmental objections. Such an OSC site provides independence from foreign control. Acceptable sites exist, affording a mild climate with excellent weather and orbital windows for each orbit around the earth.

OSC concepts considered include a moored floating (semisubmersible) design, a stationary design supported by fixed piles, and a combination of these two. The facility supports: a 15,000 foot long, 300 foot wide runway, designed to accommodate a two-staged winged launch vehicle, with a one million pound payload capacity to low earth orbit; an industrial area for HLLV maintenance; an airport terminal, control and operation center, and observation tower; liquid hydrogen and liquid oxygen production and storage, and fuel storage platforms; a power generation station; docks with an unloading area; two separate launch sites; and living accommodations for 10,000 people.

Potential sites such as the Paramount Seamount at 3°N, 91°W (in the Pacific Ocean off the north coast of South America) afford an acceptable water depth of less than 600 feet. Wave heights are below four (4) feet for eighty percent (80%) of the time. Hurricanes do not occur this near the equator, which leads to an anticipated severe design wave of only twelve (12) feet. A tolerably small current of one-half to one knot further enhances the favorable expected design conditions for such a site.

Cost estimates for the supporting structure (not the above deck facilities) have been developed for both the moored semisubmersible design and the pile supported stationary design based on an assumed installation in a 600 foot water depth. The total installed cost estimate is \$3.0 billion for the moored semisubmersible OSC and \$3.9 billion for the stationary pile supported concept based on projections from structures installed in the Gulf of Mexico where design conditions are much more severe (e.g. 80 foot design waves). Thus, these estimates are viewed as upper bounds which should decrease somewhat with the benign weather conditions of the more desirable equatorial sites. The 15,000 foot long runway is the primary cost driver in the designs, and the suitability of a floating (semisubmersible) support for the runway is questionable. Less deviation from a truly level and straight runway will result from a pile founded stationary structure. An OSC can progress from conceptual design to completion in approximately six years.

Boeing studies have shown that upgrading the Kennedy Space Center in Florida for HLLV operation will require \$2 to \$3 billion. Assuming a cost of \$60 billion for a five (5) gigawatt Solar Power Satellite (SPS) with a twenty percent (20%) transportation cost, the OSC can be shown to pay for itself with the construction of a relatively few SPS's. With ion engine cargo transportation from an orbit inclined 30 degrees, approximately five percent (5%) of the total transportation costs or \$600 million could be saved per five (5) GW SPS by an equatorial launch. The cost of the development of the ion engine drive would also be eliminated. With chemical engine cargo transportation the improvement in costs is even more apparent. Approximately twenty percent (20%) of the total transportation costs or \$2.4 billion could be saved per five (5) GW SPS by an equatorial launch.

An OSC is the logical, cost effective choice for supporting HLLV launches when an HLLV operation is justified. Site selection studies, collection of environmental and soil data to permit design and trade-off studies between different OSC layouts, operations concepts, and specific component designs should proceed to prove the cost effectiveness of the OSC concept.

THE APPLICABILITY OF MPD THRUSTERS TO SATELLITE POWER SYSTEMS*

R. M. Jones and L. K. Rudolph

Jet Propulsion Laboratory, Pasadena, California

The magnetoplasmadynamic (MPD) thruster is currently under development at JPL for a range of applications including deep space propulsion, near Earth payload transportation, and stationkeeping and attitude control of large space structures. Recent experiments tend to confirm past projections that specific impulses from 1000 to 5000 seconds at efficiencies exceeding 50% can be obtained with argon propellant. The high power self-field MPD thruster is fundamentally different than an ion thruster in that it uses electromagnetic forces rather than electrostatic to accelerate a neutral plasma. The MPD thruster has a cylindrically symmetric geometry with an annular anode ring placed at the downstream end of a discharge chamber. The discharge current flows from this anode to a centrally located cathode which extends upstream to the discharge chamber backplate. The propellant is injected through the backplate and flows through the discharge current pattern where it is ionized and accelerated by a self-field Lorentz body force ($j \times B$). The resulting thrust and specific impulse both depend quadratically on the discharge current, while the thrust efficiency increases in a more linear fashion. For reasonable specific impulse and efficiency levels, discharge currents of order tens of kiloamperes are necessary, leading to power levels of order megawatts. At this power, one MPD thruster can develop over 150 N of thrust in a volume similar to that of one 30-cm ion thruster. This high thrust density and the overall simplicity of the MPD thruster system lead to a low system specific mass and high reliability. The projected thruster efficiency for an argon MPD thruster is compared to that of an argon ion thruster in Fig. 1. The attainable MPD thruster specific impulse depends on the inverse square root of the propellant atomic weight; hence much higher specific impulses can be attained by using lighter propellants. Using helium or hydrogen the attainable specific impulse may be well above 10,000 sec. This specific impulse at thrust levels of tens of newtons makes a MPD propulsion system a candidate for stationkeeping and attitude control of large space structures such as a SPS.

The most attractive application of MPD thrusters to satellite power systems is in the area of electric propulsion for a cargo orbit transfer vehicle (COTV). Calculations have been performed in order to compare the performance of a COTV using an ion or MPD propulsion system. It was assumed that the COTV carried an SPS size payload (millions of kilograms) and that a large solar array supplied power (\sim hundred megawatts) to the electric propulsion system. The LEO to GEO trip time was estimated by using a closed form analytical approximation which included factors for steering and drag losses and losses due to Earth shadowing and degradation of the solar array. The propellant for both the MPD and Ion thruster propulsion systems was assumed to be argon. The performance of the ion thrusters was that of a projected 120-cm thruster operating at 5000 and

* This paper presents the results of one phase of research carried out at the Jet Propulsion Laboratory, California Institute of Technology under contract NAS7-100, sponsored by the National Aeronautics and Space Administration.

8000 seconds with input powers of 69 and 150 kW respectively. The MPD thruster performance was taken from the projections of Fig. 1 to be 57% efficient at 5000 sec with an input power of 6 MW. The results of the calculations for a 2×10^6 kg payload and a 150 MW power supply are presented in Fig. 2. The results show that the MPD propulsion system gives a shorter trip time with the same power and payload when compared to the ion thruster propulsion system at either value of specific impulse. More important than even the trip time benefit, may be the advantage a MPD propulsion system provides in system simplicity. Due to the large amount of input power handled per thruster, a MPD propulsion system needs far fewer thrusters than an ion thruster propulsion system. Therefore the propulsion system will be much simpler and less costly.

Another interesting COTV concept using MPD thrusters is the use of a remote power supply located on the Earth, at GEO, or somewhere in between to transmit power to the COTV in a microwave transmission. For an initial evaluation of this concept, (see Fig. 3), three transmitters were assumed to be in orbit at GEO equally spaced around the Earth. The transmitter longitudes correspond approximately to those of southern Japan, West Germany or southern France, and the western U.S. These locations may be quite practical if the SPS program becomes an international venture. The power supply for the transmitters could be a prototype, a partially completed, or a complete SPS. This concept assumes that the MPD-COTV is equipped with a microwave rectenna to convert the power to D.C. and that the vehicle receives power from only one transmitter at a time. The transmission frequency was chosen to be 22.125 GHz because at this frequency no power will reach the ground due to atmospheric absorption. The areas of the transmitter and rectenna were each assumed to be 1 km^2 and the transmitter and rectenna efficiencies are 30% and 50% respectively. Using these assumptions the LEO to GEO trip time for the MPD-COTV (including a 28.5° plane change) was calculated by integrating the equations of motion which included the dependence of the power transmission efficiency on the rectenna and transmitter separation distance. The results are presented in Fig. 4 where, for a payload of 10^6 kg and a transmitted power of 100 MW, the trip time is 105 days and the initial vehicle mass is 1.39×10^6 kg. Even with only this preliminary evaluation, this concept appears promising in terms of trip time and payload in addition to its elimination of the costly solar array and the need for subsequent annealing of the array after each trip. These calculations assumed 3 transmitters, but the concept is still feasible with only one transmitter, but the trip times will be longer. The single transmitter could be a SPS demonstration article that could be retrofitted with the high frequency transmitter.

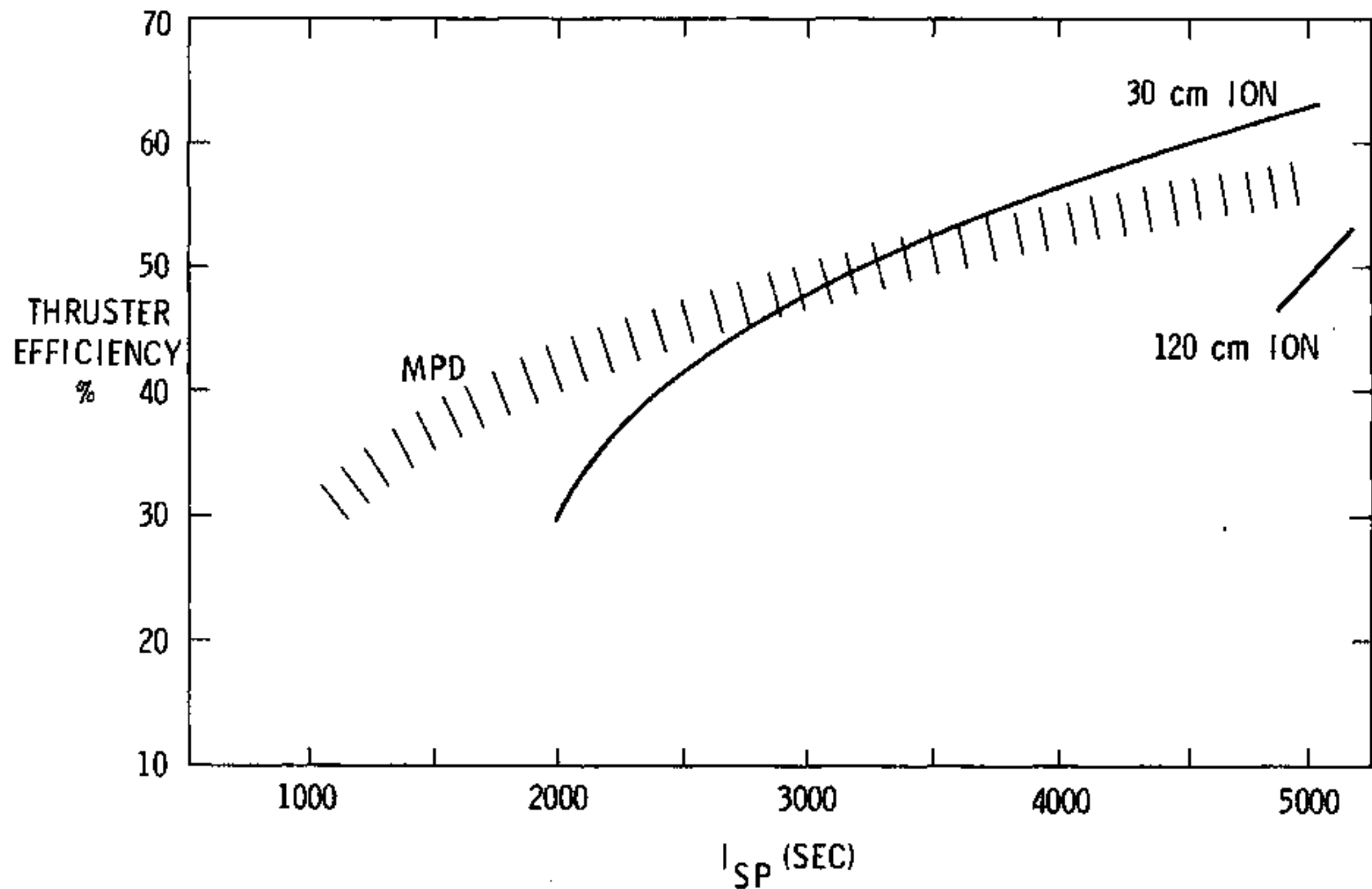

Fig. 1. Comparison of MPD and ion thruster efficiency with argon.

PAYLOAD - 2×10^6 KG

POWER - 150 MW

<u>THRUSTER</u>	<u>SPECIFIC IMPULSE</u>	<u>EFFICIENCY</u>	<u>NUMBER OF THRUSTERS</u>	<u>TRIP TIME</u>
120 CM ARGON ION (69 KW)	5000 SEC	51%	2000	205 DAYS
120 CM ARGON ION (150 KW)	8000 SEC	72%	920	213 DAYS
ARGON MPD (6 MW)	5000 SEC	57%	23	160 DAYS

Fig. 2. Solar array COTV mission performance with MPD and ion thrusters.

ASSUMPTIONS

- 1 KM² TRANSMITTER AND 1 KM² RECTENNA
- 50% EFFICIENT RECTENNA; 30% EFFICIENT TRANSMITTER
- TRANSMISSION FREQUENCY 22,125 GHz
- MPD-COTV RECEIVES POWER CONTINUOUSLY FROM ONLY ONE TRANSMITTER AT A TIME

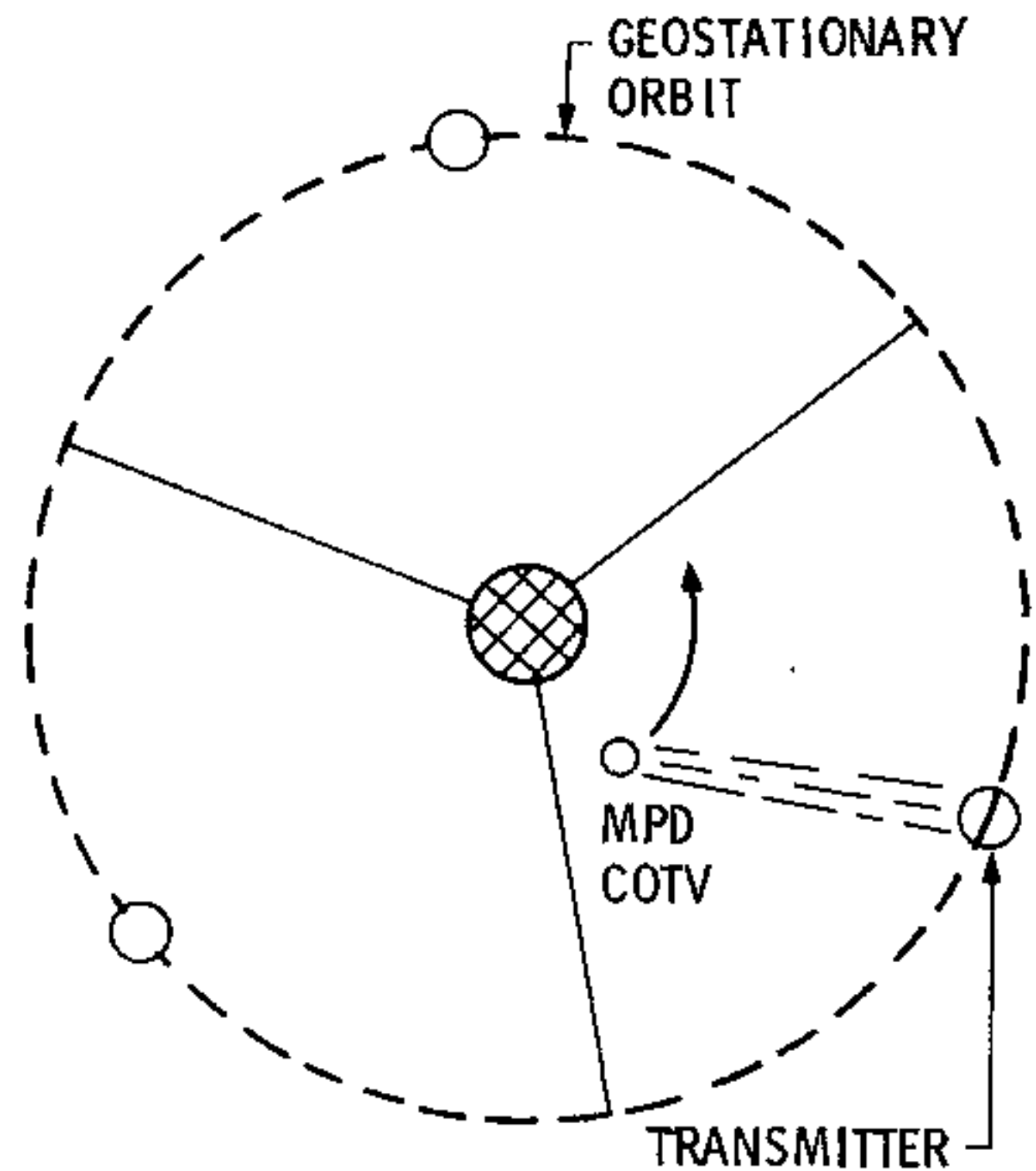

Fig. 3. Proposed microwave powered MPD-COTV concept.

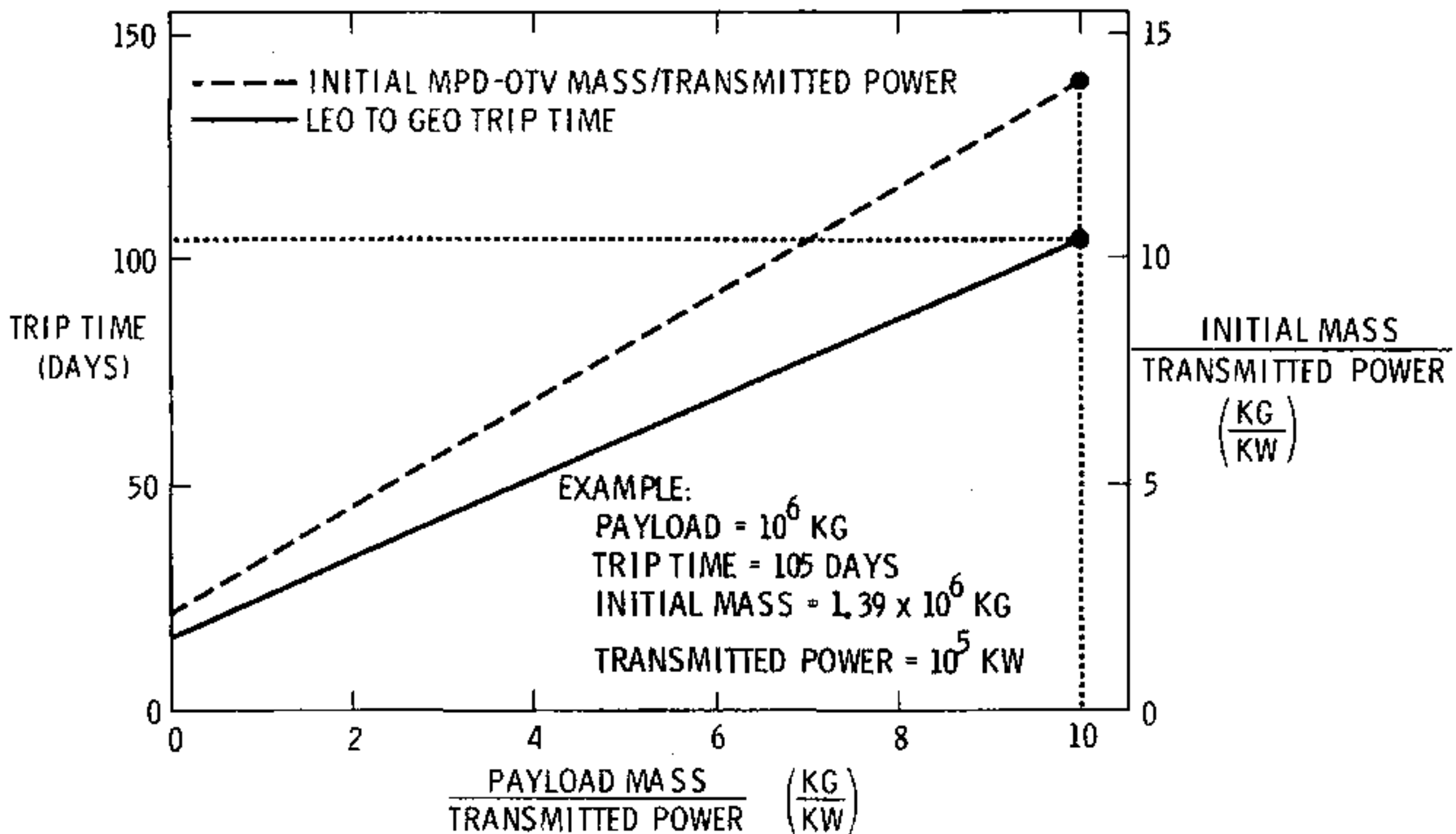

Fig. 4. Mission performance for microwave powered MPD-COTV.

SATELLITE POWER SYSTEMS (SPS) SPACE TRANSPORTATION WORKSHOP SUMMARY*

J. Preston Layton, Consultant

60 Penn Lyle Road, Princeton Junction, New Jersey 08550

In the course of studies of satellite power systems (SPS) over the past ten years, it has become apparent that the space transportation requirements are major elements in the technical and economic realization of the entire concept.

The space transportation requirement is usually divided into an Earth surface (ES) to low Earth orbit (LEO) part and a LEO to geostationary Earth orbit (GEO) or orbit-to-orbit portion which involves all intra-orbit operations including transfer through the van Allen Belts.

A considerable number of concepts have been studied for enhancing the capabilities of the current Shuttle Transportation System so that its role can be extended in the early SPS demonstrations and other flight operations. Beyond the growth and derivative versions of the present shuttle concept lie the possibilities for relatively low cost transportation from ES to LEO.

First steps in enhancing the shuttle will probably include the Titan based liquid Boost Module (LBM) and liquid propellant boosters (LPB) to replace the present solid rocket boosters (SRB). The next choice between new ballistic or winged boosters must still be made; as well as the choice between series (staged) and parallel operation.

Entirely new vehicles of large size will be required before the economic and environmental problems of the prototype, or even demonstration, SPS can be resolved. The need for single stage to low Earth orbit (SSTO) vehicles using either vertical or horizontal take-off and/or landing remains to be determined by future analyses or the course of events. In any event, considerable analysis, research and technology will be required before the choice can be properly made. Social impacts such as noise, and atmospheric pollution, locally and in the ionosphere, will need to be fully resolved.

The ES to LEO operational requirements and costs dominate the SPS space transportation scene. Launch vehicle technology must be driven to a rather sophisticated extent to meet the needs as currently perceived and this perception is immature at the present time. The workshop decided that, although rather advanced technology and well-developed operational management would be required to properly target the average cost of gross cargo payloads into LEO at 30 \$ (1979)/kg for the construction of the initial SPS, the further goal for repetitive construction of 30 to 60 SPS at 15 \$(1979)/kg for all operational payloads would require the use of very advanced, long-lived vehicles with a sophisticated operational organization using off-shore, equatorial launch sites, etc.

* The SPS Space Transportation Workshop with fifty-seven participants was held at the Sheraton Motor Inn, Huntsville, Alabama from 29-31 January 1980. It was managed by the Kenneth E. Johnson Environmental and Energy Center of The University of Alabama in Huntsville under contract to the National Aeronautics and Space Administration, George C. Marshall Space Flight Center. This paper was prepared for presentation at the Department of Energy/National Aeronautics and Space Administration Satellite Power System (SPS) Program Review, Nebraska Center, University of Nebraska - Lincoln, Nebraska on 23 April 1980.

The wide variety of orbit-to-orbit missions in support of the SPS demonstration, construction and operation need to be better defined before the vehicle concepts can be identified. Chemical Orbital Transfer Vehicles (OTVs) need further analysis and technology work and a reasonably early start on development to provide a capability that is needed in the present STS. Orbit-to-orbit including intra-orbit requirements of the 1980s should be coordinated with SPS requirements for chemical rocket OTVs in the 1990s and beyond. In-orbit propellant processing needs to be fully assessed.

Much work is needed on the concepting and research and technology work for electric rocket propulsion systems. Mission analyses including optimized high and low thrust acceleration trajectories are needed that serve the SPS requirements. High-power ion thrusters and magneto-plasma-dynamic (MPD) thrusters need urgent development attention to ascertain their characteristics. Much better coordination is needed between the electric rocket propulsion system technology planning and support and the overall NASA need for this kind of propulsion including the SPS.

More advanced propulsion systems such as dual-mode solid-core nuclear fission systems, gas-core nuclear rocket stages and mass-driver reaction engines (MDRE) need sustained attention. Orbit-to-orbit propulsion using high-power lasers should also be given attention.

The present ground based exploratory development (GBED) program in space transportation for SPS is entirely inadequate and such content as it has misses the target completely. Its primary aim should be to strengthen the present concepts but, at the same time and just as importantly, be careful not to close off any promising concepts or technologies. If the GBED is intended to be the next phase for SPS, it needs to be reconceived from the ground up with an order of magnitude increase in funding.

A greatly increased program of SPS space transportation analysis, research and technology is clearly needed. Efforts must be devoted to areas of systems analysis and technology readiness (including ground and space testing) that will reduce space transportation cost uncertainties in the next five to ten years.

Although the consensus of the Workshop supported the future prospects of the SPS, it was generally believed that much work is needed before space transportation choices could be made.

TECHNOLOGY ALTERNATIVES FOR THE SPS
P. E. Glaser and P. K. Chapman
Arthur D. Little, Inc. - Cambridge, Massachusetts 02140

The NASA/DOE reference design adopted for the SPS is based on current technology, with realistic projections for improvements in areas such as the cost and specific mass of photovoltaic cells. It provides a common benchmark for use in assessments of the implications of the SPS in societal, economic, industrial, military, environmental and other areas. However, it is recognized that new technologies are emerging which may offer advantages over those selected for the reference system. It is important to maintain a continuing evaluation of the technological alternatives, so as to exhibit potential improvements in the SPS, permit estimates of the technical and cost risk involved, and develop guidelines for future research.

It is clearly not possible to make an exhaustive list of all conceivable technical innovations which might affect the SPS, but it is nevertheless feasible to develop a systematic methodology for the assessment of technological alternatives, which may be of value both in evaluating new technologies as they are proposed and in identifying high-priority areas for research. Such a methodology involves several components:

1) Variation of Guidelines. There are a number of guidelines underlying the reference design (a build-up rate of 10 GW per year, a design life of 30 years, a microwave power beam with an ionospheric flux limit of 23 mW/cm^2 , etc.), which were originally adopted as reasonable but somewhat arbitrary assumptions. These assumptions need to be clearly identified, possible changes in them should be documented, and consideration should be given to the effect of such changes on the optimal design of the SPS, the construction scenario, and the overall cost of the system.

2) Analysis of System Functions. The primary functions which must be performed by the SPS are:

- Collection of solar energy in space.
- Conversion to an intermediate form of energy (thermal and/or electric).
- Conversion to a power beam.
- Reception and conversion to electricity on Earth.

A number of secondary functions are also required, including station-keeping and attitude control, beam control and steering, transportation and construction, etc.

Alternative technical approaches exist for most of the sub-systems required to carry out these functions, and some of them may offer advantages over those assumed in the reference design. However, changes in one sub-system often propagate throughout the design, requiring changes in many other sub-systems as well, and may involve major revision of overall system parameters -- for example, using laser instead of microwave power transmission leads to much lower optimum power output. Fortunately, a relatively elementary analysis of the system effects of sub-system changes will generally suffice for a preliminary assessment of new technologies -- in fact, it appears to be possible to set up a system tree, analogous to a decision tree, in which the branches are different sub-system choices and which explicitly displays the costs and benefits involved. Fig. 1 shows the first step in the development of such a

tree, in which only the path leading to the reference design is illustrated. The new technologies which appear promising after this simple analysis can then be given more detailed study. This process may itself suggest new approaches, and it must in any case be updated as new technologies are proposed.

3) System Sensitivity Analysis. At the present stage of development of the SPS concept, the highest priority research areas are those where major improvements could be effected in the technical feasibility and/or cost of the system. An important output of the above system analysis is thus a classification of new technologies according to their potential impact on the performance of the system.

4) Technology Status and Risk Analysis. Some alternative technologies are clearly feasible and the costs and benefits which they imply can be estimated with confidence, but others must be regarded as quite speculative. A systematic technique is therefore needed to allow risk to be taken into account in decisions regarding research priorities. As an example, for each new SPS design which is proposed, a measure of the cost risk (e.g., the standard deviation of the cost probability distribution) can in principle be plotted against the nominal cost; in terms of cost, those designs which lie closest to the origin in such a plot are of highest interest. Difficulties may however arise because realistic estimates of cost and cost risk may be unobtainable without detailed analysis.

5) External Costs, Problem Areas and Criticisms of the SPS. Another important dimension in the assessment of new technologies is the effect which they may have in areas outside design engineering. For example, use of laser power transmission might change the military implications of the SPS, simplify or complicate integration with existing utility systems, and affect the societal acceptability of this form of electric power.

One of the strengths of the SPS, as compared with other options for power generation, is the variety of technical alternatives which are available for virtually all the sub-systems and for providing support functions such as transportation. This characteristic increases confidence that the concept will prove feasible, but it greatly complicates the rational allocation of limited resources during the R&D phase. The methodology discussed here is a first step towards creation of a formal decision-analytic framework which can support design choices and program decisions as development proceeds. It provides a common basis for the assessment of alternative approaches which have been proposed or are evolving, it may facilitate innovation by identifying areas where new technologies can be of greatest benefit, and it should eventually allow creation of an extensive data base concerning design options which can be of value to the SPS design engineer as well as to management of the program.

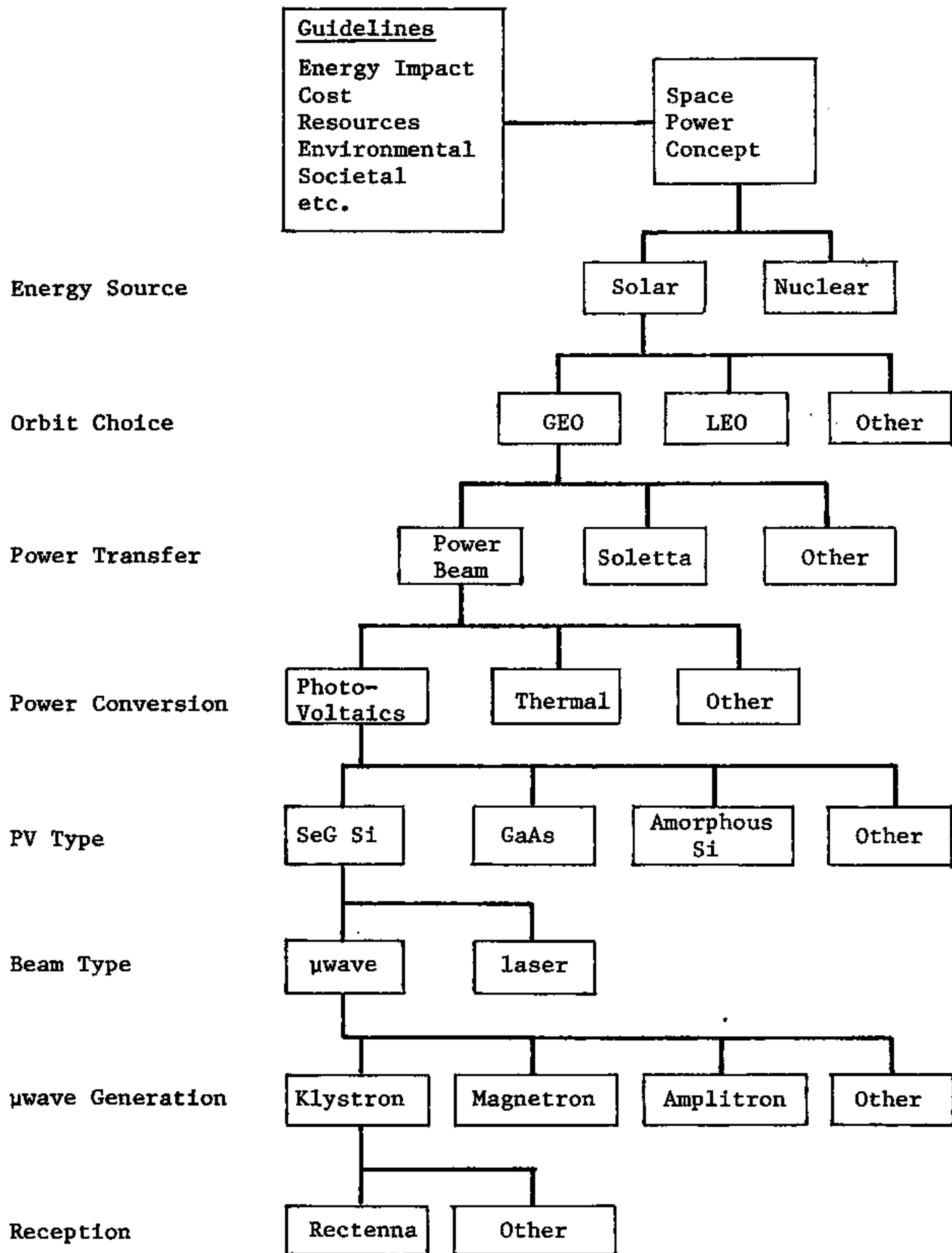

Figure I Space Power Sub-System Tree

PROTOTYPE SOLAR POWER SATELLITE OPTIONS

B. R. Sperber - Boeing Aerospace Company
K. E. Drexler - Massachusetts Institute of Technology

An optimal path cost minimization problem is presented every time a new system is implemented. A system like the solar power satellite (SPS) is a special challenge because the anticipated development costs are large and, due to optics, the microwave power transmission link can not economically be scaled down to powers of less than a gigawatt. This paper addresses the choice of options for the prototype SPS, which is currently the least well defined of the three major items in the SPS development program. (The other two major items are the construction base and the heavy lift launch vehicle.)

The reason for undertaking any development program is to reduce the risk of failure of subsequent projects. Risk is quantifiable and is basically the program cost multiplied by the reduction in probability of program success due to the risky action. According to Kierolff (Ref. 1) there are four classes of risk. (See Table I) While in an ideal society prototyping would only reduce technical risks, in the real world it may reduce the effects of the other three types of risk by allowing them to be quantified earlier.

In the case of the prototype SPS, the mathematical criterion for when one should prototype is

$$D C_f \geq C_p,$$

where D is the difference in program probability of success with and without the prototype option being considered, C_f is the cost of program failure and C_p is the prototype cost. With careful and judicious evaluation of the parameters in this relation (or one very much like it--the one here is very simplified) an objective choice of program plan can be made. (Ref. 2)

Current thinking on requirements for SPS prototypes result in lists like Tables II and III. The generally accepted most difficult technical aspect that the prototype will have to demonstrate is the safe and efficient transmission of commercial amounts (greater than 10 Mw) of power from synchronous orbit to the Earth's surface through all types of atmospheric conditions. The important similarity parameters of the microwave power link are frequency, beam efficiency, desired sidelobe levels and a real atmosphere and ionosphere in the beam path with full scale power density (approximately equal to received power/area) propagating through. Transmitted power/area is not critical for reasonable simulation of full scale beam conditions, although it is an important parameter that should be achieved in in-space subarray tests. For efficient power transmission at S band, the product of the transmitting and receiving areas must be approximately 10^{14} m⁴. To realistically test atmospheric and ionospheric effects the received power/area should be that of the full scale satellite (currently 230 w/sq. meter). As a result, the power and aperture area of the transmitting antenna are set once the size of the receiving array is decided. That decision follows from a simple cost minimization exercise.

The most common SPS design, termed "conventional" for purpose of this paper, consists of separate solar and microwave transmitting arrays connected by DC busses and rotary joints. The designer of a prototype of a conventional SPS has a critical choice to make. He may transmit a beam which reaches full scale SPS peak power density on the ground using an oversized, quite nonstandard low power density transmitting array, or he may retain standard subarrays in a smaller than full scale aperture for less than full power density on the ground. Because the former choice results in a design physically larger and quite unlike

the full scale SPS the latter option is inevitably chosen. The disadvantage of this is that the operational feasibility of safe and efficient high power microwave beaming and reception is not demonstrated.

A solution to the above problem is to use a large microwave reflector to increase the transmitting aperture. Since reflectors are likely to be less massive than full scale satellite waveguides by almost an order of magnitude the substitution of reflector aperture for waveguide aperture can be favorably made.

The critical technical aspect of reflectors is keeping the proper shape and attitude. By using active control a great reduction in structural stiffening mass and complexity may be achieved. Two basic approaches to implementation of actively controlled microwave reflectors are being considered: mechanical and electrostatic. Both methods show great promise and are currently under study by groups sponsored by Langley Research Center and others. (Refs. 3-5) For reflectors of the size required, a mass per unit area of .5 kg/sq meter or less appears feasible.

Figure 1 and Table IV present a comparison of typical conventional and augmented aperture SPS prototypes. It may be seen that the aperture augmented conventional prototype has a clear mass and cost advantage. For a sandwich type of SPS (where the solar array, microwave power amplifiers and antenna elements form a planar sandwich) this advantage is slight due to the already very low power density at the transmitting aperture.

Because aperture augmentation is not a necessary technology for full scale SPS's (although it does offer some advantages--see Ref. 6) its use on the prototype will increase the risk involved somewhat. However, it is likely to reduce the cost involved to a degree that more than compensates for this. If an aperture augmented prototype meets all the other basic SPS demonstration requirements (and we see no reason why it shouldn't) it will almost surely be possible to construct and operate a conventional SPS because a technically more rigorous test article has been demonstrated.

Space does not allow detailed discussion of several other similar choices between risk and cost on the prototype SPS. They include whether or not to build a full scale heavy lift launch vehicle and construction base for the prototype and whether or not to use full scale production methods on various components. It is recommended that similar quantitative methods be used to make the decisions involved.

References

- 1) Kierolff, H.E., "Satellite Power System (SPS) Financial/Management Scenario," DOE HCP/R-4024-13, Oct. 1978.
- 2) Reiffa, Howard, "Decision Analysis," Addison Wesley, Reading MA, 1968.
- 3) Lang, Gersh and Staelin, "Electrostatically Controlled Wire-Mesh Antenna," Electronics Letters, 14, 655-656, Sept. 28, 1978.
- 4) Tankersley, B.C., "Maypole (Hoop/Column) Deployable Reflector Concept for 30 to 100 m Antenna," AIAA Paper 79-0935.
- 5) Ward, J.C., Editor, "Large Space Systems Technology - 1979," NASA Conf. Publication 2118, Nov. 7-8, 1979.
- 6) Drexler and Sperber, "High-Power Microwave Optics for Flexible Power Transmission Systems," Proc. of 1980 DOE/NASA SPS Program Review, April 1980.

TABLE I. TYPES OF RISK (Reference 1)

"Insurance" Risk

International Conflict Risks (External Conflict)

U.S. Political Variation Risks (Internal Conflict)

Technical Risks

(Lost) Opportunity Costs

Project Engineering Costs

TABLE II. GENERAL PROTOTYPE DEMONSTRATION REQUIREMENTS

(In Order of Importance)

Electromagnetic Power Link Feasibility Demonstration

Component Integration Verification

Construction Technology Verification

Cost Performance Verification

TABLE III. SPECIFIC PROTOTYPE REQUIREMENTS

- o Operate at GEO
- o Provide meaningful power to a utility grid (tens to hundreds of megawatts)
- o Demonstrate reliable control of power beam and its sidelobes
- o Provide full scale satellite received microwave power/area
- o Demonstrate construction operations
- o Demonstrate plant factor $>.8$
- o Demonstrate reliable, repeatable startup and shutdown
- o Demonstrate maintainability and repairability
- o Provide traceable cost/power performance data

TABLE 4. VARIOUS PROTOTYPING OPTIONS

Type	Conventional w/Small Xmt. Antenna	Reference Conventional	Aperture Augmented Conventional	Reference* Sandwich	Aperture Augmented Sandwich
Transmitting Antenna Dia.	.8 km	1 km	.25 km/2.8 km	1.8 km	1.2 km/2.9 km
Receiver Antenna Dia.	10 km	10 km	3.6 km	4.7 km	2.9 km
Design Procedure	Pick minimum power density for ground tests; zero taper low power subarray and matching solar array.	Build conventional reference SPS	Scale link area to solar array for minimum mass (or cost)	Build reference solid state sandwich SPS	Scale link area to sandwich for minimum mass (or cost)
Peak Transmitted Power/Area	600 W m ⁻²	22 kW m ⁻²	22 kW m ⁻²	550 W m ⁻²	550 W m ⁻²
Peak Received Power/Area	10 W m ⁻²	230 W m ⁻²	230 W m ⁻²	230 W m ⁻²	230 W m ⁻²
Beam Efficiency	.8	.95	.95	.8	.8
Grid Power	.15 GW	5 GW	.70 GW	2x1.21 GW	.59 GW
Masses (No Growth)					
Solar Reflector	0	0	0	5,840 MT	1,430 MT
Solar Array	2,200 MT	27,900 MT	5,030 MT	13,030 MT	3,200 MT
Transmitter	3,300 MT	13,800 MT	1,680 MT	0	4,630 MT
μwave Reflector (.5 kg m ⁻²)	0	0	6,710 MT	0	4,630 MT
Total w. 25% Growth	6,875 MT	52,100 MT	16,775 MT	23,590 MT	11,580 MT

* Ref: W. Finell
Priv. Comm., 4-16-80

FIGURE 1. THE VARIOUS PROTOTYPE OPTIONS ILLUSTRATED

KEY:
SR - Solar Reflector
SA - Solar Array
T - Transmitting Array
MR - μwave Reflector

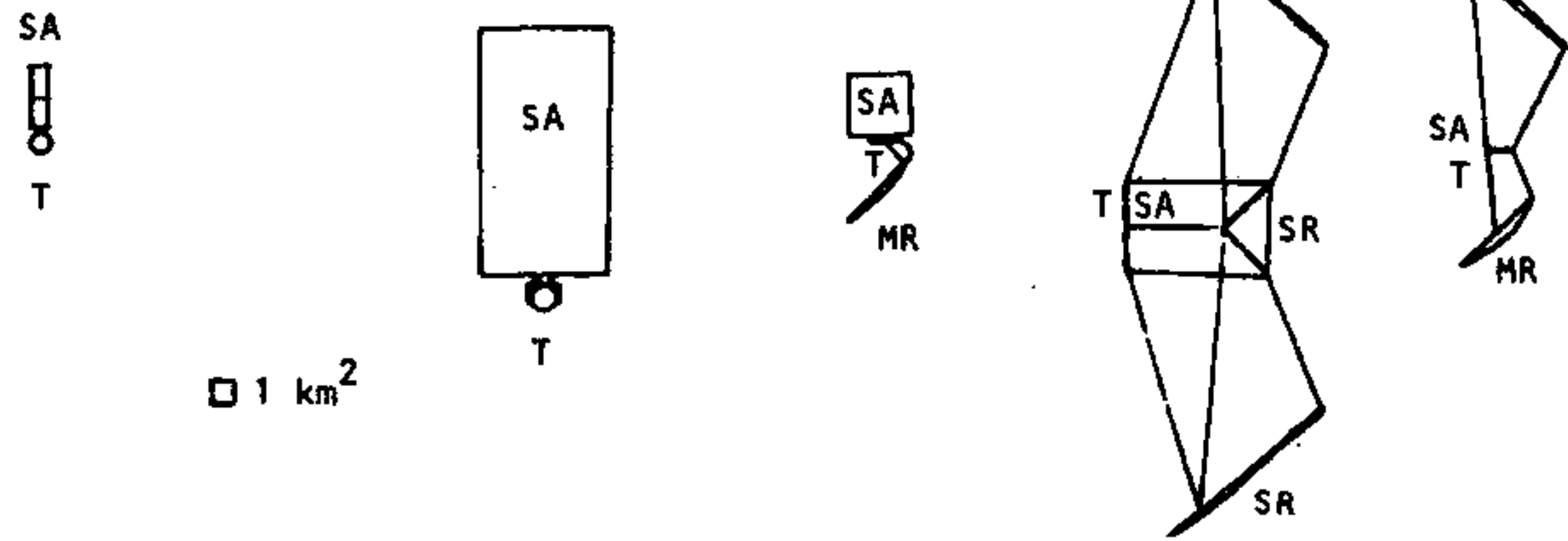

RECENT WORK ON USE OF LUNAR MATERIALS FOR SPS CONSTRUCTION
Gerard K. O'Neill (presented by David Criswell)
Princeton University, Princeton, New Jersey 08544

During 1978 and 1979 several workshops were held under the sponsorship of the Space Studies Institute. Experts in spacecraft design, rocket mission optimization, mass-driver design, chemical processing and industrial automation took part in these workshops. An earlier version of the results will appear, in part, in Astronautics and Aeronautics. The purpose of the workshops was to extend in a logical way the concepts of scaling and bootstrapping⁽¹⁾ studied earlier in 1976 and 1978 NASA studies on the use of nonterrestrial materials.^(2,3) In the latest work, the group examined first the question of how small an operation could be mounted that would make a productive use of the lunar materials. In that operation, as far as possible only equipment being developed by NASA for other purposes would be used (the Shuttle itself, without augmentation, small crew workstations, spacesuits, a conventional chemically-powered orbital transfer vehicle, and whatever minimal tele-operators are developed in the course of the next few years).

The interim conclusion of the workshops was that the most cost-effective scenario would be one in which a very small installation would be put on the Moon: a mass-driver plus a small chemical process plant plus a small "machine-shop" would be located in orbit, probably about 2/3 of the way from the Earth to the Moon. By "machine-shop" is meant a partially-automated, general purpose production facility akin to a small job-shop, capable of making most (but not all) of the components of additional, identical mass-drivers, processing plants and machine-shops. On the basis of present-day commercial experience in industrial automation, the group concluded that it would be practical for the machine-shop to be about 90% automated. Many of the machines could be directed by human operators on Earth through radio and TV links, with local microprocessors to handle decisions only on a 3-second time scale, that being the round-trip time lag for signals between Earth and Moon. The machine-shop would produce only relatively simple, repetitive, heavy components. All electronics and all high-precision machine components would be brought from the Earth.

It was calculated that the system would have the capability of replicating about 90% (by weight) of its own components. Its human crew would be mainly for maintenance, especially for those unusual or unforeseeable failures that could now be repaired by remotely-directed equipment. The lunar facility would be installed by humans originally, but might only be revisited occasionally thereafter. Its purpose would be to export (via mass-driver) material to the space facility, and also to replicate locally additional mass-drivers, process plants and machine-shops.

To establish a baseline for the "leverage" gained through the use of lunar materials, an optimized electrical design was completed (3/80) for a small lunar mass-driver. The design took advantage of the six years of design development that have now gone into mass-drivers.^(2,3)

Earlier, detailed work by the Lunar and Planetary Institute under NASA sponsorship (D. Criswell, Principal Investigator) had established that a chemical process plant on the lunar surface would be able to process at least 40 times its own mass per year.⁽⁴⁾ The group budgeted six tons for such a plant, to yield in three months a total throughput of 60 tons, comprised mainly of an aluminum output of 8 tons, iron output of 3 tons, silicon output of 12 tons, and oxygen output of 24 tons.

Such a plant could provide sufficient feedstock for a machine-shop to replicate in 90 days an additional mass-driver, process plant and machine-shop. The total installation on the Moon would be 37 tons.

In the scenario of the workshop group, the lunar installation would be called upon to produce 33 tons of finished products in three months. The author had an opportunity to check the correspondence of that figure to the 6-ton mass of the machine-shop, in the course of a recent visit to Japan, and found that the 33 tons/6 tons rate of production assumed for the chemical process plant is well within current industrial practice on Earth. During the 90-day replication time, about four tons of specialized or labor-intensive components would have to be brought from the Earth to complete the replication of the facility. The liquid oxygen to bring that four tons from Shuttle altitude to the Moon is within the 24 tons of oxygen-output that the initial lunar facility would produce in that period.

On commissioning of the replica of the original installation, the throughput of material into space from the Moon would be doubled, to 4,700 tons/year. Six more doublings, over a period of less than two years, would bring the total throughput to 300,000 tons per year, with operation only during the lunar days. That 300,000 tons of lunar material in space would be more than sufficient to provide the metals, glasses and silicon needed for the construction of 90% to 96% of the mass of one Solar Power Satellite per year.⁽⁵⁾ The process plant and machine-shop located originally in orbit, and its replicas, would operate in full-time sunlight. The table below shows the figures for the process plant.

Installation in space, to process initial
throughput of 2340 tons/year

Process plant mass	29 tons
Machine-shop mass	29 tons
Habitat mass	<u>12 tons</u>
Total mass	70 tons
Outputs in 90 days:	
Aluminum	82 tons
Iron	30 tons
Silicon	117 tons
Oxygen	230 tons

The initial installation in space is therefore more than capable of producing in 90 days the 63 tons of finished products that would constitute 90% of its mass, the remaining 10% for a replica being brought from the Earth. The oxygen produced by the original plant would be far more than required for supply of propellant to bring the necessary 7 tons of Earth-built components for the replica. With the 90-day replication time, the orbital facility, like the lunar facility, would be capable of growth to a value of 300,000 tons/year of throughput in seven doublings, or about two years.

The workshop group has not yet studied the optimization of the mix of products in space between replicas of the primary system and machinery designed for the production of SPS components. Presumably, in the simplest scenario, on reaching the 300,000 ton/year figure the entire output of the facility would be turned to the production of those machines. On the basis of the NASA-funded study⁽⁵⁾ directed by R. Miller and D. Smith of M.I.T., the orbital facility could produce in one to two years most of the machines that would be needed for a steady production thereafter of one 10-GW SPS per year.

For the installations that would be replicated, the total amount of unique equipment for which R & D would have to be carried out would be approximately 15 tons. Using cost figures based on Shuttle experience (approximately \$60 million per ton) the total investment required for establishment of the initial installations on the Moon and in space, for verification of the overall plan and initiation of the replication process, would therefore include one billion dollars for R & D and \$0.4 billion for 16 Shuttle flights, needed to lift 107 tons of equipment and 340 tons of propellant to low Earth orbit. Total program investment to the point of first replication appears therefore to be well under five billion dollars.

The interim conclusion of the workshop group is that the concepts of scaling, bootstrapping, and replication appear certain to provide major cost savings in any program, such as that of the SPS, which requires the emplacement of large payloads in high Earth orbit. It is also clear that there is great value in an approach of that kind, which can achieve high return on a modest investment without exceeding the lift capabilities of the unaugmented Shuttle system. The workshop studies will continue, turning to a detailed examination of optimized growth scenarios and the details of equipment design.

At present (1980) mass-driver development is adequately funded at a level of \$250,000 through the NASA Office of Propulsion and Power. Other than the mass-driver, the only item of equipment in the scaling and replication method that is without industrial precedent is the chemical processing plant. Therefore the Space Studies Institute will initiate a grant, approximately in September 1980, of approximately \$100,000 (first year) for research and development on a bench-chemistry level system for the separation of simulated lunar soils into pure elements.

The research reported in this article was supported by the Space Studies Institute, Box 82, Princeton, NJ 08540.

REFERENCES

1. O'Neill, Gerard K., "The Low (Profile) Road to Space Manufacturing," March 1978 Astronautics and Aeronautics (A/A), Vol. 16, No. 3, pp. 18-32.
2. O'Neill, Gerard K., and O'Leary, Brian, eds., Space-Based Manufacturing from Nonterrestrial Materials, AIAA, New York, 1977.
3. Billingham, John, Gilbreath, William and O'Leary, Brian, eds., Space Resources and Space Settlements, NASA SP-428, NASA, Washington, DC, 1979.
4. Criswell, David, Extraterrestrial Materials Processing and Construction, NASA Johnson Space Center, Houston, Texas, 1978.
5. Miller, Rene H., and Smith, David, Extraterrestrial Processing and Manufacturing of Large Space Systems, CR-161293, NASA Marshall Space Flight Center, Huntsville, Alabama, 1979.

A CONTRIBUTION TO THE AVAILABILITY OF LUNAR RESOURCES FOR POWERSAT CONSTRUCTION

T. A. Heppenheimer
 Center for Space Science
 Fountain Valley, California

A number of authors have discussed the use of lunar resources in powersat construction, wherein these resources are to be transported with the aid of a lunar mass-driver. Previous contributions by the present author have included studies of achromatic trajectories and of the mass-catcher and associated transfer trajectories to a space manufacturing facility. An important problem, heretofore essentially untreated, is the minimization of cross-track errors in the launch of payloads by mass-driver. This problem is important because an error $\Delta \dot{y} = 1$ cm/sec (normal to the lunar surface) produces a miss of 500 meters, for a catcher near the L_2 libration point. If the error is $\Delta \dot{z} = 1$ cm/sec, parallel to the lunar surface, the miss is 30 meters.

Figure 1 gives a block diagram of the mass-driver; Figures 2 and 3 indicate the technology which is applied. The proposed mass-driver buckets or payload-carriers employ the design concepts of Chilton, Kolm and associates, as developed in 1976. In Fig. 2, the new feature is the payload constraint/release system. The payload is conceived as a triaxial ellipsoid having axes in the approximate ratio 0.95:1.00:1.05, with mass 20 kg, and consequently with mean diameter 25 cm. It is of unprocessed lunar soil and is contained within a bag woven from lunar-derived fiberglass, as proposed by Criswell, the fiberglass being prepared at the lunar base. In addition, the payload is flashed with a thin coating of metallic aluminum, to make its surface electrically conducting. The payload housing then is a double hemiellipsoid, moulded to the reference payload shape. The rear housing half is strongly braced and secured. The forward half fits tightly against the rear half during bucket acceleration (at 1000 m/sec^2).

Passive magnetic damping: Following the main acceleration phase is a section of mass-driver track which is precision aligned; the optical alignment system used in the Stanford Linear Accelerator appears applicable. This section, up to several kilometers in length, gives a very smooth bucket motion wherein pre-existing bucket oscillations may die out. Chilton et. al. give reference oscillation frequencies as 28 Hz laterally, 20 Hz vertically. Figure 4 illustrates a novel means for damping: electromagnetic fins.

The phenomena of magnetic damping is well-known: if a conducting loop oscillates within a transverse magnetic field, then by Lenz' law there arise eddy currents within the loop, the decay of which absorb energy at the expense of the oscillation. In the present instance, each of the cruciform fins of Fig. 4 has associated a conductor carrying current I , parallel to the fin length L and separated by clearance C . Fin width is W and resistance of the fin is R ;

$$R = 2\rho(L + W)/A_x \quad (1)$$

where ρ is resistivity in ohm-meters, A_x is conductor cross-sectional area. D.J. Ross has given the equation of motion of a bucket undergoing lateral oscillations which are damped using electromagnetic fins:

$$\ddot{\xi} + \frac{2}{Rm} \left(\frac{\mu_0 I L W}{2\pi C(C+W)} \right)^2 \dot{\xi} + \frac{k}{m} \xi = 0 \quad (2)$$

ξ is y or z ; m , bucket mass taken as 40 kg; k , spring constant taken as 12.6×10^5 newton/meter for $\xi = z$ and 6.3×10^5 for $\xi = y$, following Chilton et. al. If $L =$

1 meter, $W = 32$ cm, $A_x = 4$ cm², $C = 4$ cm and the fins are of copper then $R = 1.138 \times 10^{-4}$ ohm and critical damping is achieved for $I = 2.022 \times 10^5$ amperes when $\xi = z$, or $I = 1.700 \times 10^5$ amps when $\xi = y$.

Two other events occur during passive damping. The track twists or corkscrews to give the bucket a rotation 0.1 rad/sec about the x-axis. Also a trimming acceleration is applied to adjust bucket velocity to a desired value.

Separation and snapout: Figure 5 illustrates the means whereby the payload is separated from the bucket. High launch accelerations will have wedged the payload tightly in the housing; the "wrenchout" is an abrupt deceleration applied to the bucket by track electromagnetics, causing the payload to wrench free. The forward half of the payload housing is supported by a telescoping boom, which collapses forward, receiving the payload in a compliant fashion. A step-function acceleration-deceleration translates the bucket forward with respect to the payload, providing clearance. Then the bucket undergoes snapout: a sudden lateral translation which leaves the payload free in space.

Snapout is accomplished with zero lateral perturbation on the payload from interaction of bucket magnetics with fine-grained iron in the payload material. It is assumed that magnetic field strength B is always sufficient to saturate the iron to its maximum magnetic moment. Then the perturbation $\dot{z} = \int (dB/dz) dt$ which is driven to zero by considering that with the bucket magnetics of Fig. 2, dB/dz shifts from positive to negative with increasing z (distance above bucket midplane). When $\dot{z} = 0$, bucket passes behind a mu-metal barrier for isolation.

Downrange correction: Figure 6 illustrates the scanner, lateral corrector, and overall system for correction. The payload shape is a triaxial ellipsoid:

$$Ax^2 + By^2 + Cz^2 + 2Dxy + 2Exz + 2Fyz + Gx + Hy + Iz + 1 = 0 \quad (3)$$

The nine coefficients specify payload semi-axes, orientation in space, and position of the center of figure. Six lasers, arranged as shown on an octagon, are interrupted by the payload in flight; the timed interruptions serve to determine all nine coefficients. The center of figure, however, is at distance d from the center of mass and the latter is to be determined. Three sequential determinations of the coefficients of eq. (3) allow specification of the rotation axis; so we first find the axis of the rotation applied during passive damping. We then torque the payload in the z-direction, to give a rotation component $\omega_z \sim \omega_x = 0.1$ rad/sec; this torque involves a bias motion $\dot{z} = 0.4 (a/d)\omega_z$; a is payload mean radius. Then three sequential scans determine the new rotation axis; its intersection with the old axis given the center of mass.

The corrector is a cylindrical array of conductors, any of which may be charged to simulate a line of charge acting on a conducting sphere (the payload). The resulting force has magnitude

$$F = \frac{\lambda^2}{\pi\epsilon_0} \left(1 - (a/R)\right)^{-1/2} \cdot (a/R)^2 \sin^{-1}(a/R) \text{ newtons} \quad (4)$$

where R is distance from sphere center to the line charge, λ line charge magnitude in coulombs/meter. Each line charge is regarded as produced by a cylinder of radius r ; within the corrector, these cylinders (conductors) have mutual centerline separation b . Hence the capacitance of such a conductor is

$$C = \lambda/V = 2\pi\epsilon_0 / \left\{ \cosh^{-1} \left((b^2 - 2r^2)/2r^2 \right) \right\} \quad (5)$$

Voltages $V \sim 10^6$ volts suffice. Thus, lateral dispersions can be reduced so as to permit aim within a 3-meter circle at L_2 , for 0.1-cm tracking accuracy.

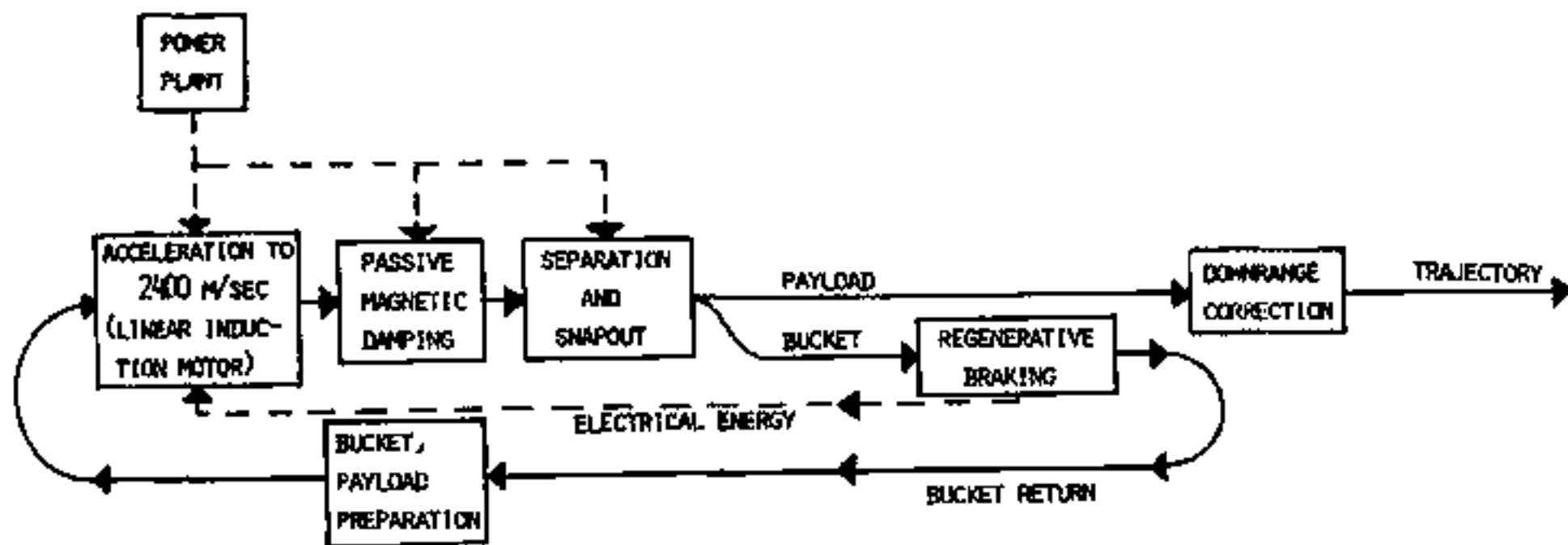

Figure 1. Block diagram of lunar mass-driver for launching of lunar materials at $>10^6$ tons/year. (Modified from Chilton et. al., AIAA Progress Series, Vol. 57, 1977, p. 40)

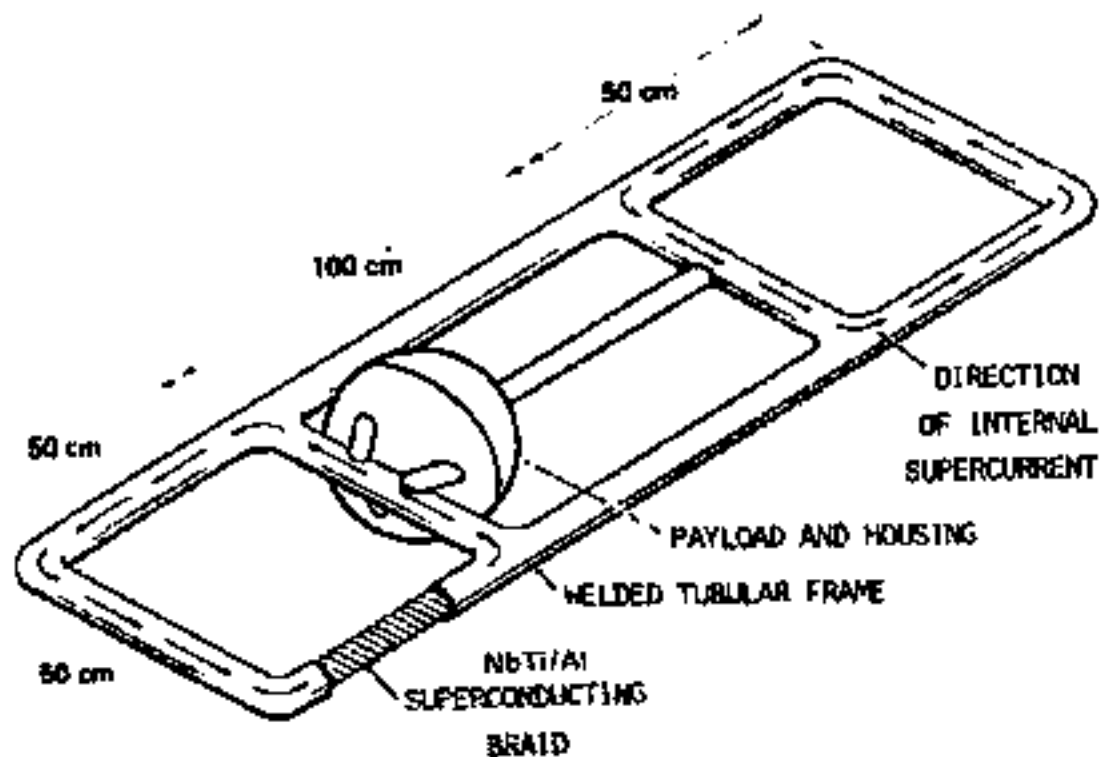

Figure 2. Mass-driver bucket. Frame is cut away to show superconducting braid. Note payload constraint/release system. (Modified from Chilton et. al., op. cit., p. 50)

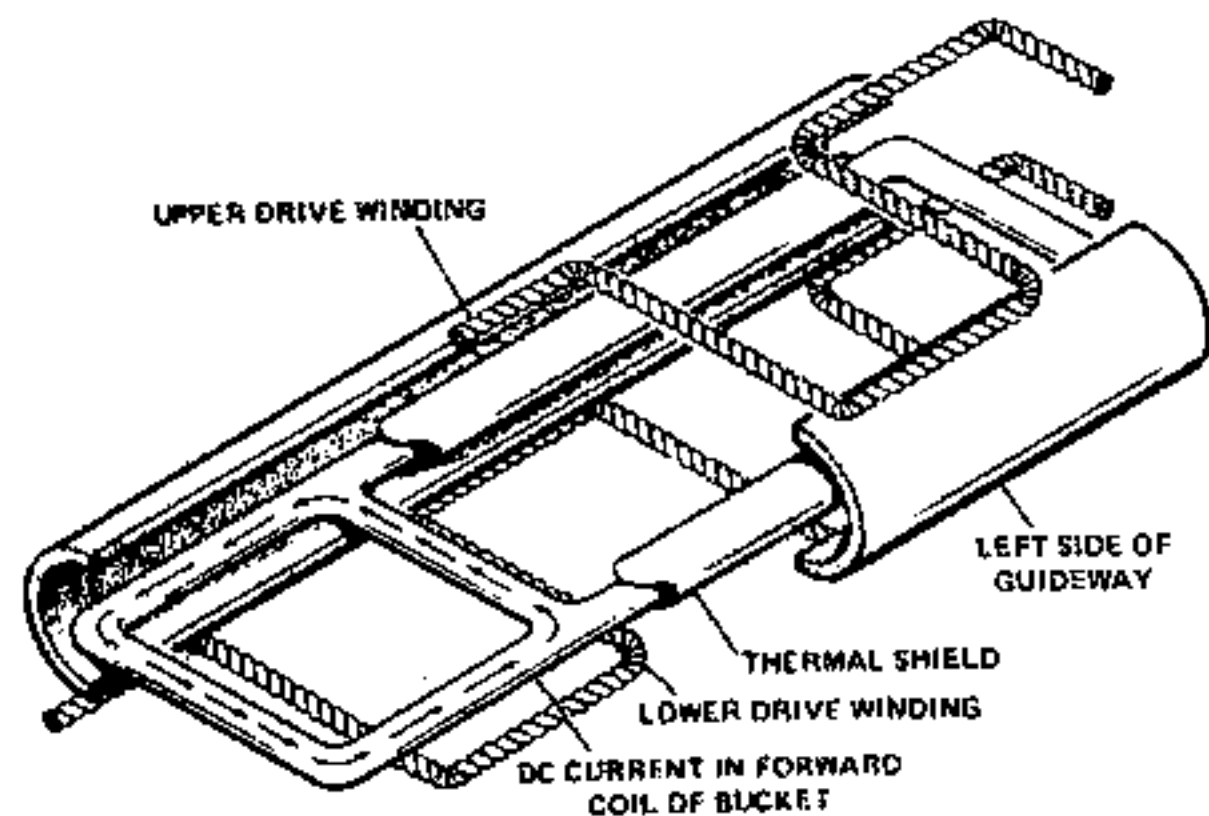

Figure 3. Mass-driver geometry. A portion of the drive windings for one of three phases is shown. Forward portion of bucket superconducting loop appears with thermal shield removed. Payload and support not shown. (After Chilton et. al., op. cit., p. 42)

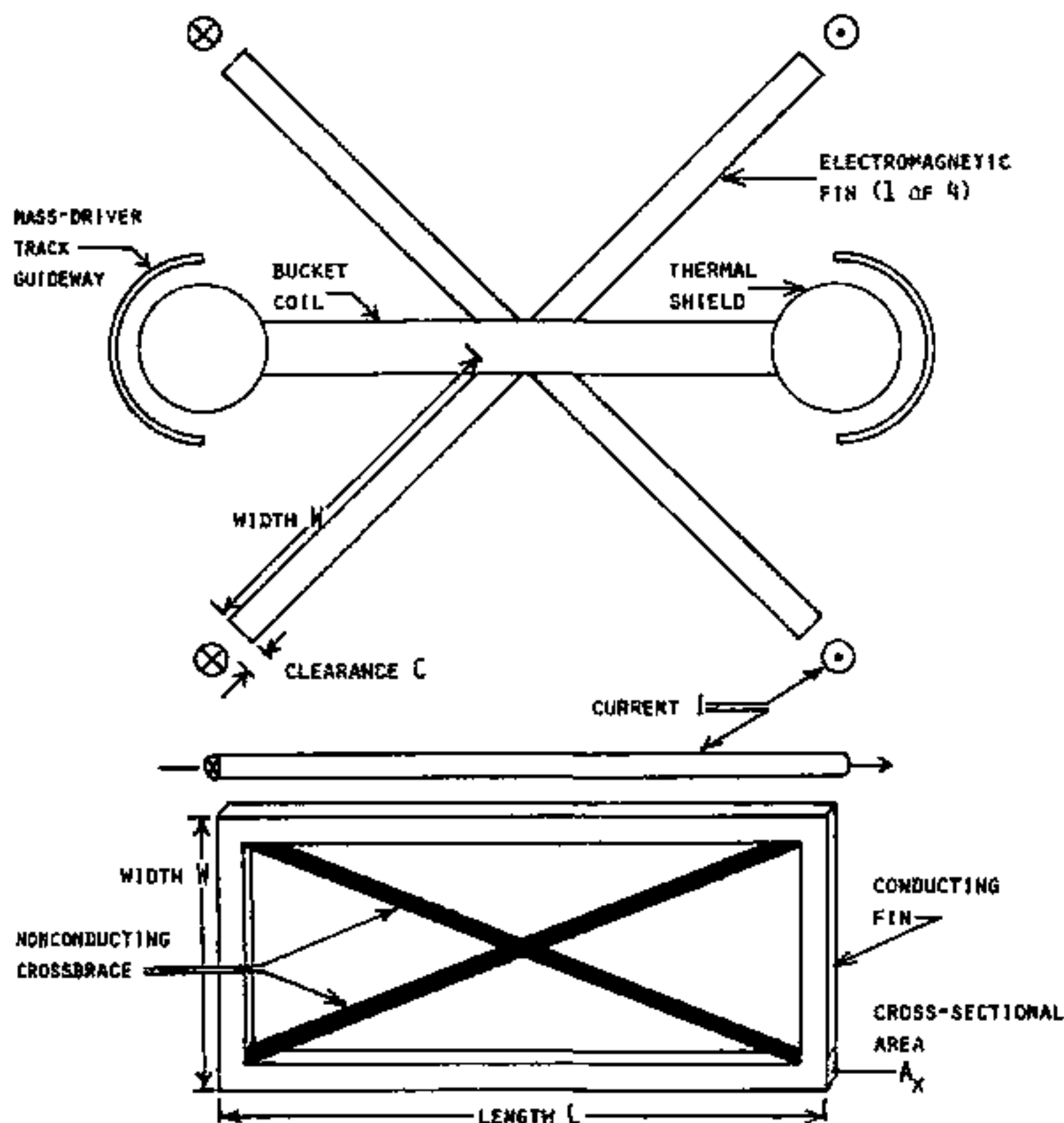

Figure 4. Electromagnetic fins for passive magnetic damping of bucket oscillations. Top, bucket is shown in end view with payload and restraint removed. Bucket oscillatory motions (resolvable into cruciform components) induce eddy currents in fins owing to adjacent currents I , thus damping these motions. Bottom, mechanical design of fin as a crossbraced rectangular conductor. Note that adoption of this concept will force re-design of the mass-driver/bucket concept of Figs. 2, 3.

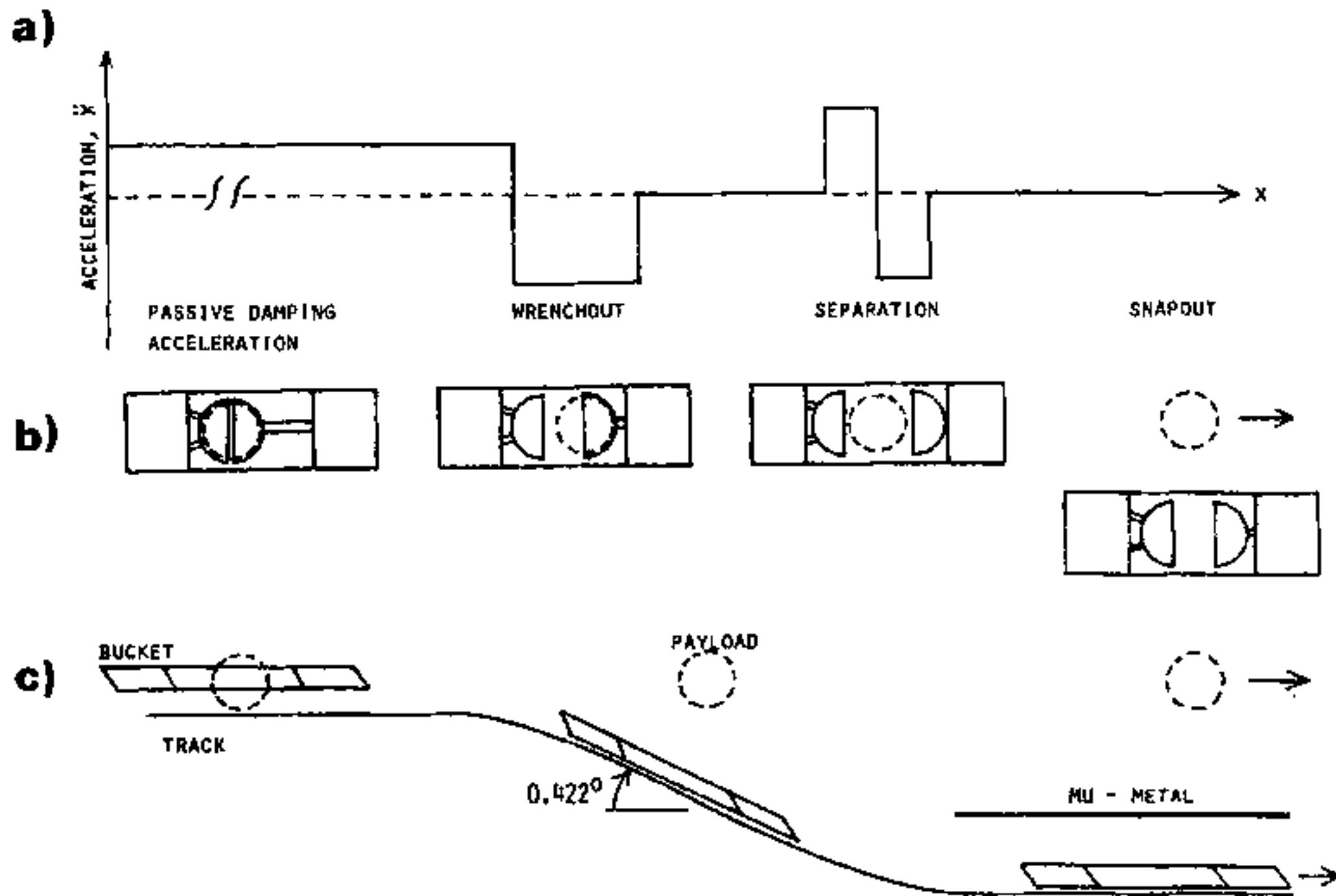

Figure 5. Separation and snapout. (a) Acceleration on bucket, \ddot{x} , as schematic function of along-track distance x . (b) Separation of payload from bucket; see text for discussion. (c) Detail of snapout; note mu-metal barrier.

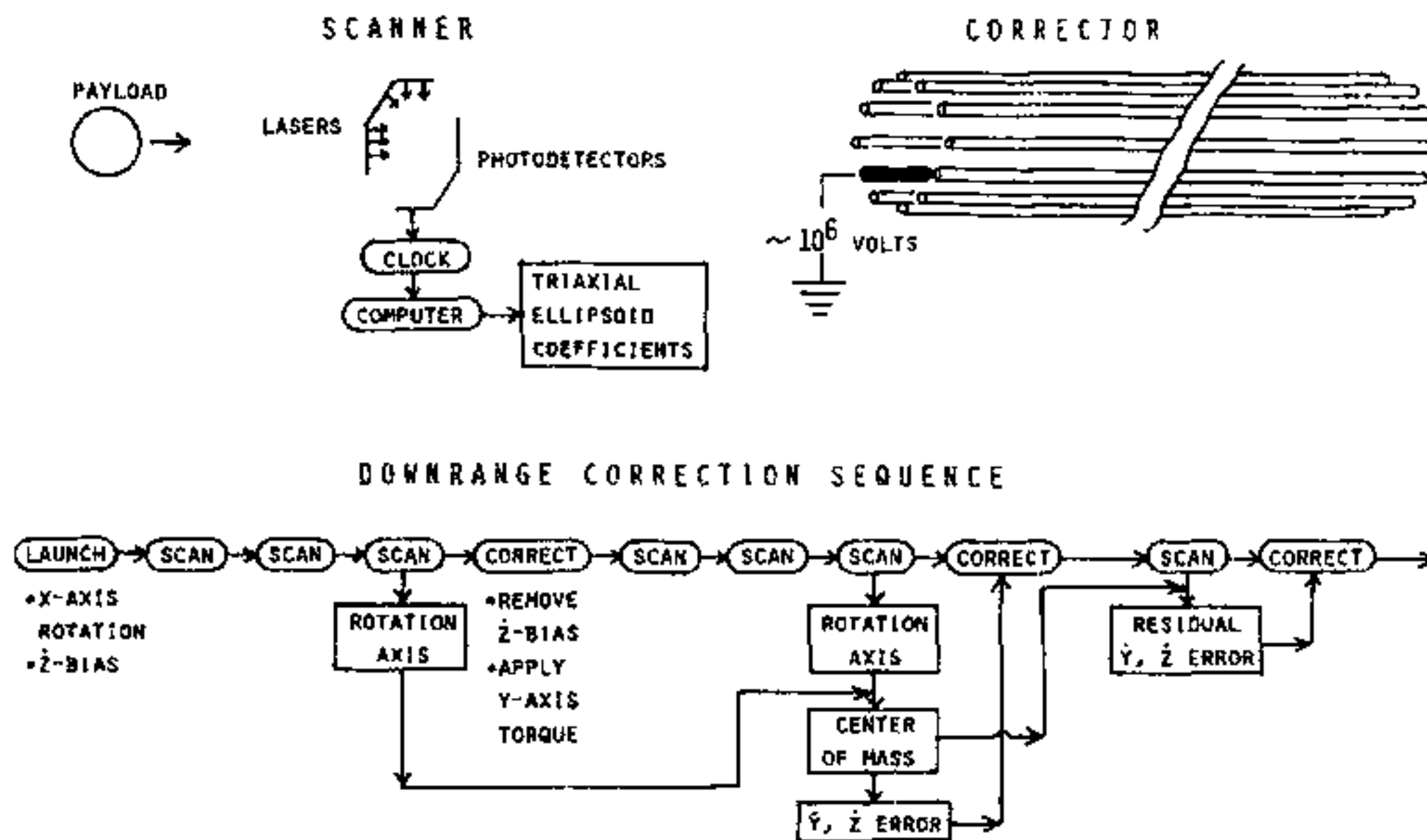

Figure 6. Downrange correction. Scanner employs six lasers plus timed photodetectors to determine payload location, dimensions, and orientation. Corrector charges a selected conductor within an array for electrostatic deflection of payload; payload is electrically neutral but conductor induces a charge redistribution. Correction sequence determines initial rotation axis, applies a lateral torque to payload, then redetermines rotation axis, thus yielding payload mass center location. Thereafter observed payload lateral position errors are interpreted as due to lateral velocity components of center of mass, which are electrostatically corrected. Final scan/correction steps occur atop a mountain some 75 kilometers (30 seconds flight time) downrange from launch site.

PASSIVE SOLAR REFLECTOR SATELLITE REVISITED

C. Polk and J. C. Daly
 University of Rhode Island
 Department of Electrical Engineering
 Kingston, R. I. 02881

Principal disadvantages of the solar power satellite, as normally proposed, are its cost and low overall efficiency (about 7 per cent). To overcome conversion losses and to avoid the need for photo-voltaic cells, an alternative system has been proposed: passive light-weight reflectors in space which direct the incident solar energy to a specified location on the surface of the earth. There either photo-voltaic cells are employed or, after light concentration by another reflector system, a steam turbine alternator on a "solar tower", or a similar 'conventional', relatively high efficiency cycle is used for electricity generation. This idea has been discarded in the past, because the small, but nevertheless significant divergence of rays at the earth-solar distance due to the finite diameter of the sun would produce a minimum spot diameter of 330 km on the earth's surface if a single passive reflector or lens is used in geostationary orbit.

Spot size can be substantially reduced if the satellite is placed at lower elevation. Nevertheless, since the geostationary orbit is probably most attractive if one satellite is to provide continuous illumination for a single ground station, and since the problems arising from reduction of spot size are, in principle, the same at any sufficiently large elevation, we examine the more difficult problem of the passive reflector in geostationary orbit.

If a single satellite in geostationary orbit is used, the following constraints apply to the design of the optical system:

Distance from source (sun) to lens or mirror system	$d_o \sim 1.5 (10^8) \text{ km}$
Image distance (i.e. distance to ground station)	$d_E \sim 3.58 (10^4) \text{ km}$
Object size (sun diameter)	$D_o \sim 1.39 (10^6) \text{ km}$
Slope angle between extreme rays = 2 · numerical aperture at input of satellite system, <u>if energy from the entire solar disk is to be used</u>	$\sin \alpha \approx \alpha \sim 0.533^\circ = 9.305 (10^{-3}) \text{ radians}$
Specified diameter of illuminated area on earth	D_E
Fraction of the solar <u>power density</u> which is to be incident on the surface of the earth	k

It is probably desirable that $k \sim 1$ (giving about 1 kW/m^2), since $k > 1$ may produce undesirable environmental effects and $k < 1$ would require a larger reflector area on the ground to generate a specified amount of power. Also conservation of energy requires that the power intercepted by the first aperture in space be equal to the power received on the earth

$$D_A^2 = k D_E^2 \quad (1)$$

Applying as first approximation purely geometric optics, we are in effect attempting to produce on the surface of the earth an image of the sun. Using for each lens or mirror

$$\frac{1}{p} + \frac{1}{q} = \frac{1}{f} \quad (2)$$

where p = object distance, q = image distance, f = focal length, we obtain the following results:

Single lens system:

Since $p = d_o$, $q = d_E$, therefore $f \sim d_E$

$$\frac{\text{Image diameter}}{\text{Object diameter}} = \frac{q}{p} = \frac{d_E}{d_o} = \frac{D_o}{D_E} \quad (3)$$

$$D_E = D_o \frac{d_E}{d_o} \approx 331 \text{ km}$$

Two lens system:

In analyzing the system we refer to Figure 1. However, Fig. 1 is only a schematic diagram of the optical arrangement. To minimize separation between optical elements one might use, for example, a diverging lens followed by a converging lens. A realization of this might be a reversed reflecting telescope of the Cassegrainian or Schwarzschild type in which the first reflector is a convex spherical (or hyperbolic) mirror which receives the incident solar radiation through an aperture in the larger spherical (or parabolic) mirror; alternatively one might use in place of the central opening axially off-set surfaces. Another realization of the schematic diagram of Fig. 1 might be a concave spherical (or parabolic) mirror followed by a Fresnel lens (zone plate).

Applying (2) and (3) in succession to both lenses of Fig. 1 we obtain with $f_1 \approx d_1$ (since $d_o \gg d_1$) and $f_2 \approx d_2$ (since $d_E \gg d_2$)

$$D_E = \frac{d_1}{d_2} \frac{d_E}{d_o} D_o = \frac{f_1}{f_2} 331 \text{ km} \quad (4)$$

Thus by selecting appropriate focal lengths ($d_1 \approx f_1$) \ll ($d_2 \approx f_2$) and separation for the two lenses, the spot size on the earth can be made arbitrarily small (but is ultimately limited by diffraction effects). However the principal limitation of the system arises from the size of the required mirrors or lenses. Applying (2) and (3) again we note that

$$\frac{d_1}{d_2} = \frac{D_A}{D_B} \quad (5)$$

Combining (4) and (5) we obtain

$$D_E = \frac{D_A}{D_B} 331 \text{ km} \quad (6)$$

for $D_E < 331 \text{ km}$ D_B must be larger than D_A , then using condition (1)

$$D_B = \sqrt{k} 331 \text{ km} \quad (7)$$

Thus if the power density on the earth is specified to be 1/2 of that available in space, the size of the largest reflector becomes $D_B \approx 234 \text{ km}$.

This result, while not encouraging, does not rule out the passive reflector system since it may be possible to build and deploy even very large passive reflectors (Al foil or metal coated plastic) at reasonable cost. Likewise construction of very large Fresnel zone lenses consisting of alternate rings of

plastic having different index of refraction or thickness might be feasible.

If one can accept for a given application power densities on the earth lower than those from the daytime sun, another approach to reducing spot size is available. Referring to Fig. 2 we may use light baffles with either a single lens (or reflector) or even a plane reflector. The light baffles must restrict the numerical aperture at the satellite location for light coming from the sun. Thus if $\alpha_1 = \sqrt{k}\alpha$, the spot diameter on the earth will be reduced to $D_E = \sqrt{k} 331 \text{ km}$. Since the effective area of the sun is now reduced by k , the power density over the illuminated area on the earth will be reduced by k . The light baffle could consist of a thin (few cm) sheet of plastic made of optical fibers with very small numerical aperture. With this arrangement the single reflector would have to be curved only if its diameter D approaches D_E ; however one needs $D \geq D_E$ to realize the maximum possible power density.

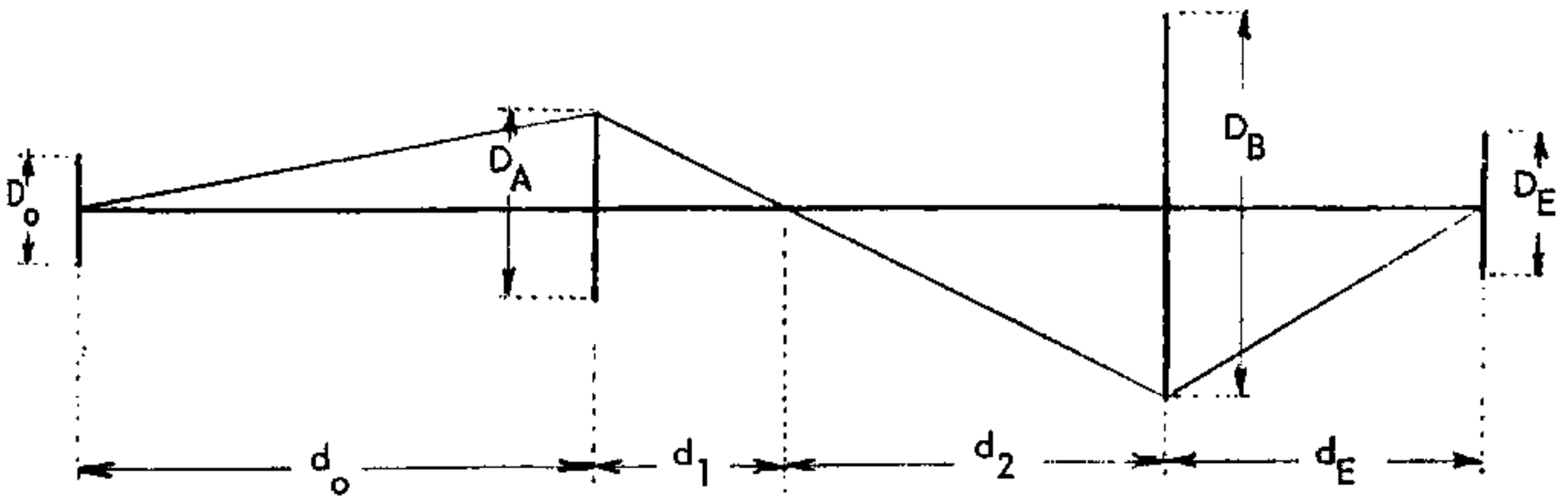

FIG. 1. TWO LENS SYSTEM

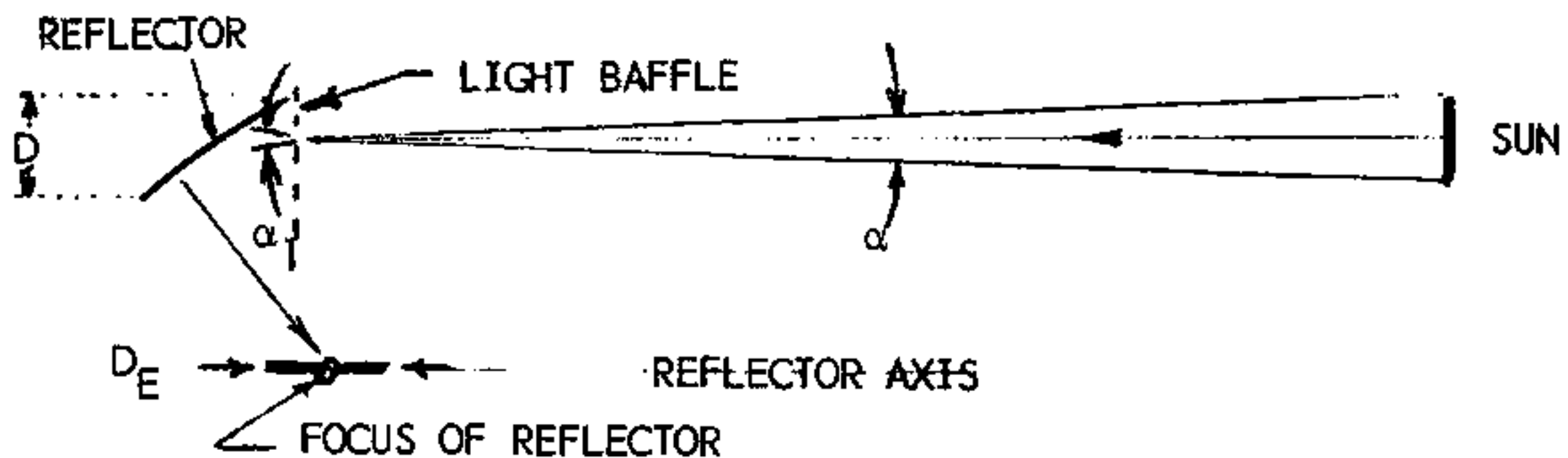

FIG. 2. SINGLE REFLECTOR WITH BAFFLE

COMPARISON OF LOW EARTH ORBIT AND GEOSYNCHRONOUS EARTH ORBIT

J.E. Drummond

Power Conversion Technology, Inc.

11588 Sorrento Valley Rd. #18 San Diego, Ca. 92121

The potential advantages of Solar Power Satellites are attenuated by the costs of transmitting power from geosynchronous orbit to load centers on earth. The capital cost of the transmitting facilities is dependent on the areas of the antenna, A_T , and rectenna, A_R . These two areas are connected together by the requirement of high efficiency power transmission¹:

$$A_T A_R \approx 3\lambda^2 R^2 / \cos(\theta) \quad (90\% \text{ transmission efficiency}) \quad (1)$$

where $\lambda = 0.12\text{m}$ is the wavelength of the power radiation, R is the distance between antenna and rectenna, and θ is the angle between the beam and local zenith at the rectenna. The area A_R used here does not include the public safety exclusion area which will have to be many times larger. In an attempt to greatly reduce this initial cost, proposals have been made² to decrease R by a factor of ~ 5 . According to Eq(1) this would allow both A_T and A_R to be greatly reduced. Since the power transmission subsystem represents about half the capital cost of the total SPS reference system, it is worthwhile to consider the low orbit alternative at an early stage so that its technological, environmental, social and political problems and advantages may be assessed in comparison with those of the geosynchronous forms. It is the purpose of this paper to point out the salient features of a low orbit system in regard to these issues.

Technological Problems. In order to remain in sunshine all the time, these orbits must be sun synchronous; they must precess $360^\circ/\text{year}$ (as a result of the torque exerted on them by the equatorial bulge of the earth). This imposes a relation between their inclination angle, i , relative to the equatorial plane, and their semi-major axis, a :³

$$a \approx 12,351 \text{ km} \times [\cos(i) \times (1 + 2e^2)]^{2/7} \quad (2)$$

where e is the eccentricity of the orbit. It is also necessary that the major axis not rotate in the orbital plane or rotate with a period of one year in order that the largest distance of the satellite from the earth occur at winter solstice. This will allow the orbit to always clear earth's shadow. The condition that no rotation occur determines $i = \pm 63.4^\circ$. These two orbits alone (with minimum eccentricity, $e = 0.012$) would be adequate to supply the base load needs of centers between latitudes 40 and 60° with rectenna areas an order of magnitude smaller than those required to receive power from an antenna of given area at geostationary orbit. (This result allows for 360° variation in arrival directions of the power beam during each 6 hour period). The condition that the major axis rotate in the same direction as the orbital plane precesses determines $i = \pm 73.1^\circ$. Four such orbits are shown in Fig.2. The condition that the major axis rotate opposite to the orbital plane precession determines $i = \pm 46.4^\circ$ which are shown in Fig.3. The rectenna areas required are given in Fig.4. Now e must be determined so that the largest distance of the satellite from the earth, $(1+e)a$, extends beyond the winter solstice shadow. This determines $e \geq 0.38$ for $i = \pm 46.4^\circ$. These are iso-insolation orbits; the power system based upon them is abbreviated IPS. It is apparent that this system is complementary both to an earth-born solar power system and to the geostationary SPS which both favor low latitudes. As Reinhartz has pointed out at this conference⁴ the enormous rectenna and safety exclusion area required by geostationary SPS sorely impacts SPS viability in Europe. This problem is substantially alleviated by the IPS system.

The antennas in the IPS satellites need to scan only within a cone of half

angle $\sim 29^\circ$ about the nadir which should be readily accomplished by electronic phase control alone. This surely will be both more reliable and of much smaller mass than the universal joint required between antenna and solar collector array on a geostationary SPS. Both antennas and rectennas must be redesigned to accommodate this scanning as well as circular polarization.

An obvious problem is how to use the power generated by a satellite which is temporarily out of sight of any load center. Within these areas special load centers can be established to convert sea water to hydrogen fuel (or methane in the Sargasso Sea) for instance. A detailed study of these possibilities is needed.

The low orbits do experience a higher gravity gradient, but with some forms of solar power satellites this can be used to advantage. The low orbits experience a smaller tidal effect than do geosynchronous satellites and they experience far less drift toward the east-west stable points at 76°W longitude and 108°E longitude. A detailed study of orbit perturbations and potential accidents needs to be made.

The IPS orbits have little advantage or disadvantage in regard to transportation from the LEO staging/pre-assembly orbits. Electric propulsion would carry partially constructed satellites up to geosynchronous orbit or over to the retrograde sun-synchronous orbits. There also may be little advantage or disadvantage in relation to Van Allen belt and solar flare radiation. These issues need study.

The primary technological issue in regard to reliability is the fact that the IPS orbits chosen do not enter the earth's shadow and hence these satellites do not experience the very great thermal shock which must be repeatedly experienced by geostationary satellites during Spring and Fall equinox. The economic impact of relaxation of this severe engineering requirement should be studied.

Environmental Problems. The first experimental indications of the underdense thermal self-focusing instability were presented at this conference.^{5,6} The instability growth rate observed at Platteville⁵ was too slow to allow the moving power beam from an IPS orbit to significantly stimulate it. Extended experimental studies of this instability should be made.

Social and Political Problems. These problems have received very little comparative study for the low vis-a-vis geosynchronous orbits. The mainspring of the difference is that the low orbit, IPS is inherently also an Interregional Power System. In order to be economically efficient, the system must serve regions covering most of the earth's surface. It favors latitudes 36 to 56° .

Acknowledgement. The vital criticism and encouragement received from Dr. Kraft Ehrlicke is gratefully acknowledged.

References. (1) W.C. Brown, Spectrum, Mar. 1973, p.40. (2) J.E. & R.N. Drummond, Solar Power Satellite, Congressional Subcommittee Hearings, 20 Feb. 1976, p.637 & Apr. 12, 1978, p.416. (3) K. Ehrlicke, "Space Flight", 1963. (4) K.K. Reinhartz, DOE SPS Prog.Rev., Apr. 20-25, 1980. (5) C. Rush, ibid. (6) D. Phelps et al, ibid. (7) V. Chobotov, J. Spacecraft Rockets, Apr. 1977, p.249.

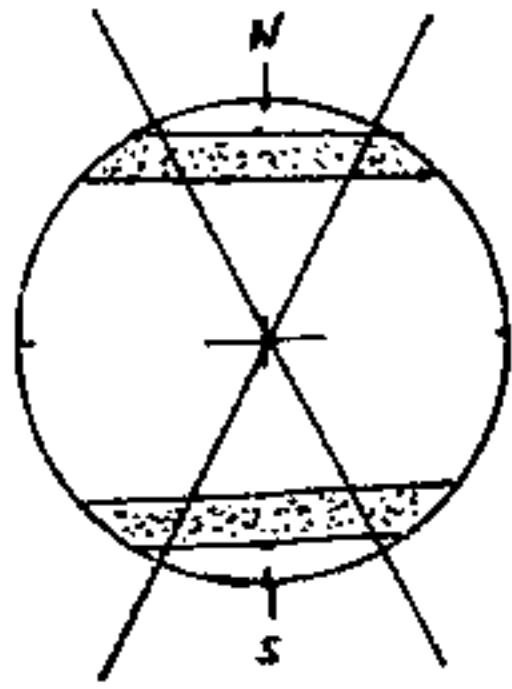

Fig. 1: Two near circular orbits inclined at $\pm 63.4^\circ$, could supply base load power to miniature rectennas between 40° and 60° latitude. These could provide for Europe's continuous power needs plus intermittent power to lower latitudes.

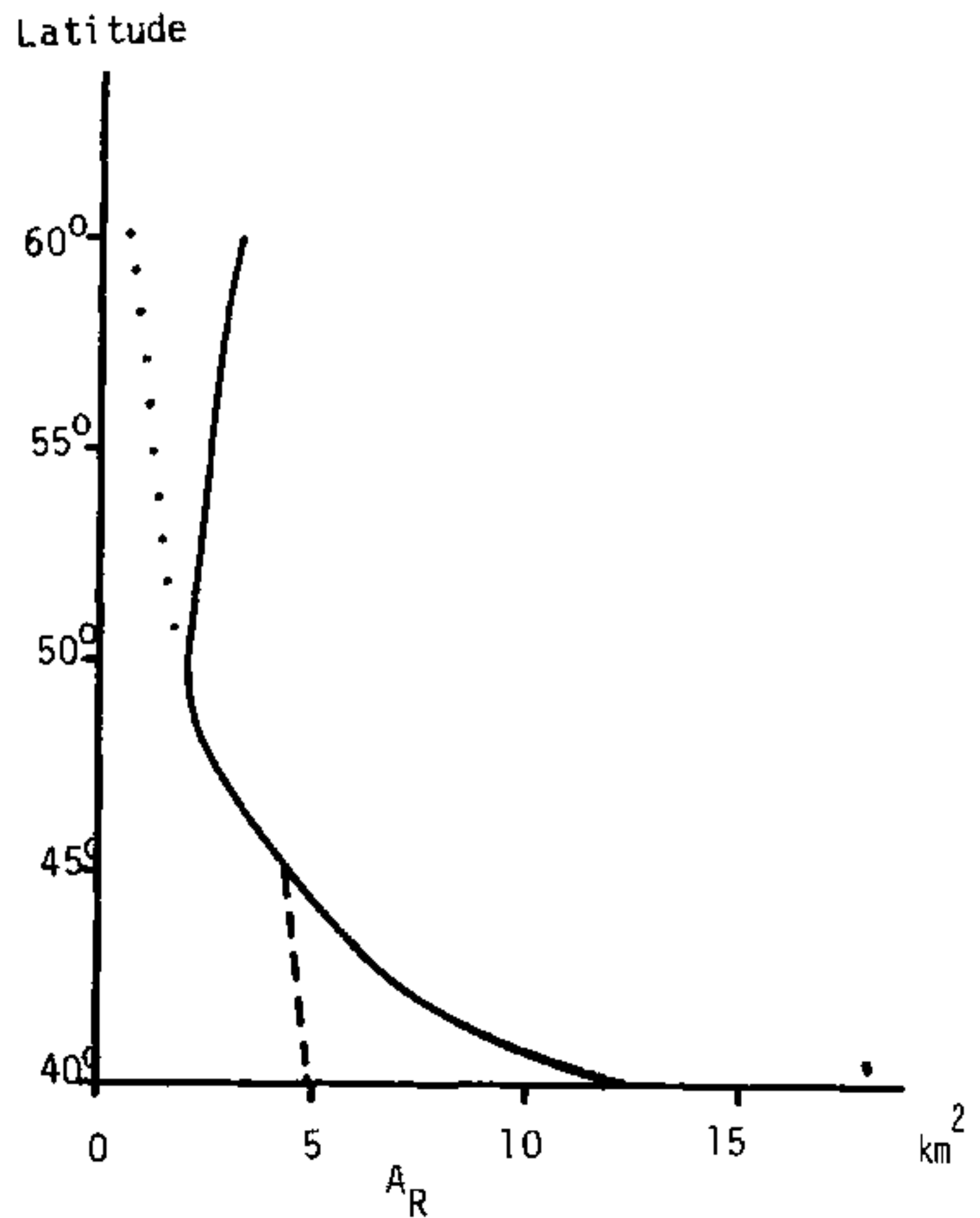

Fig. 4: Solid Curve: Rectenna area (A_R) required to receive power continuously from a pair of orbits shown in Fig. 1. The curve is normalized for satellite antenna areas of 1 km^2 . Dotted extension shows effect of the four additional orbits shown in Fig. 2. Dashed curve shows effect of adding the two orbits of Fig. 3.

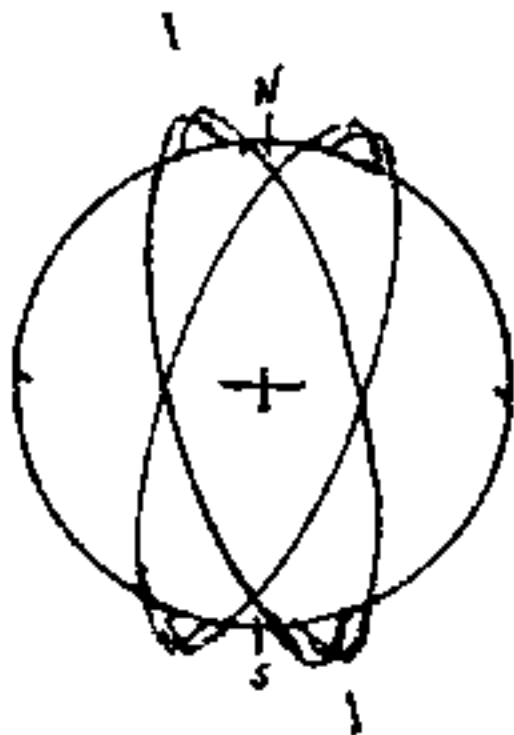

Fig. 2: Four additional orbits which could be added to those shown in Fig. 1. These circular orbits are inclined at $\pm 73.1^\circ$ and rotated by $\pm 14.3^\circ$ about the polar axis.

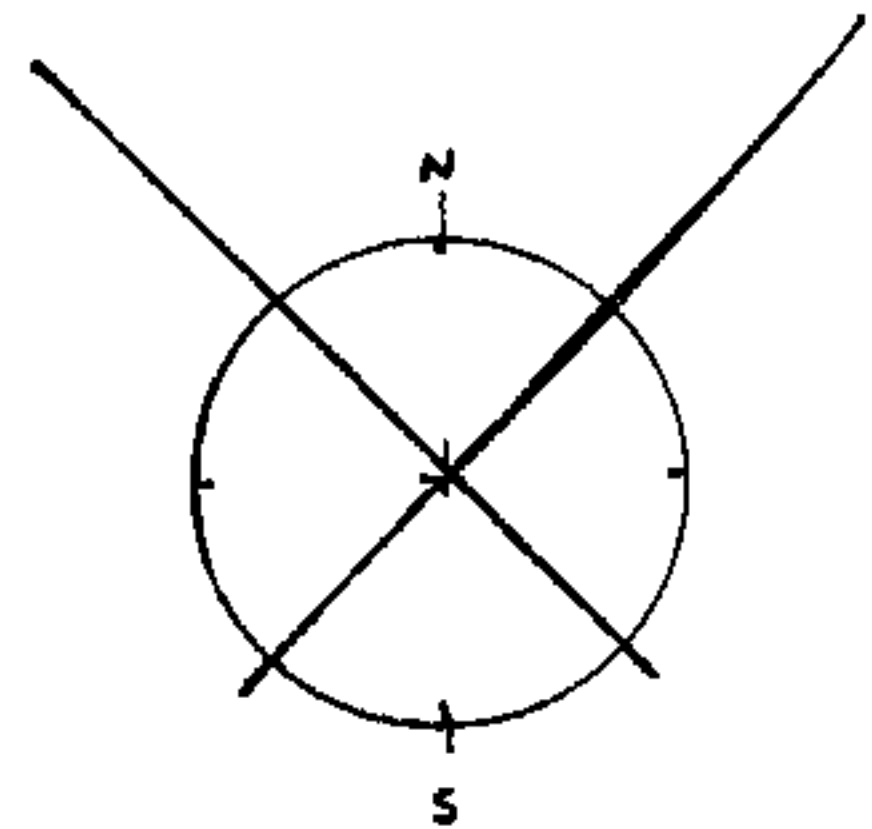

Fig. 3: Two additional orbits which could be added to those shown in Figs. 1 and 2. These orbits are inclined at $\pm 46.4^\circ$. Their eccentricity is 0.38.

Gerard Andlauer, IP
5 rue de Castelnau
Mundolsheim
67450 France

The Infrared Alternative

The satellite structure consists in a three-pointed star that rotates on itself while it turns around the planet so as to train ever the same axis to a district on the Earth where the ground receptor structure is located. The branches of the star are parallelepipeds 1 kilometre in length and width and 100 metres broad that intersect at 120° in the focus of a triple hyperboloid. These define a lattice of pipes as cubes of 10 metres edge. The external "peel" is ordered in panels of polymethacrylate and glass fibers of 1 square metre size. The interface of them is blackened in order to absorb the incident solar radiation and reemit it on the inside at a far infrared that cannot traverse the coat panels: the general structure is acting as an orbital green house.

The infrared is trapped and focalised along the axis that faces toward the ground receptive structure. It traverses at the end a screen of filtering panels on an interference principle that retain the wavelengths such as to be absorbed during the path in the Earth atmosphere particularly through the H_2O molecules. They only let out the wavelengths that coincide with optical apertures so as the 3.8, 8.5 or 10.6 microns gaps. The emergent beam will avoid any loss of energy due to absorption or diffusion in the atmosphere before it reaches the ground receptive surface.

THE SATELLITE CAPTOR

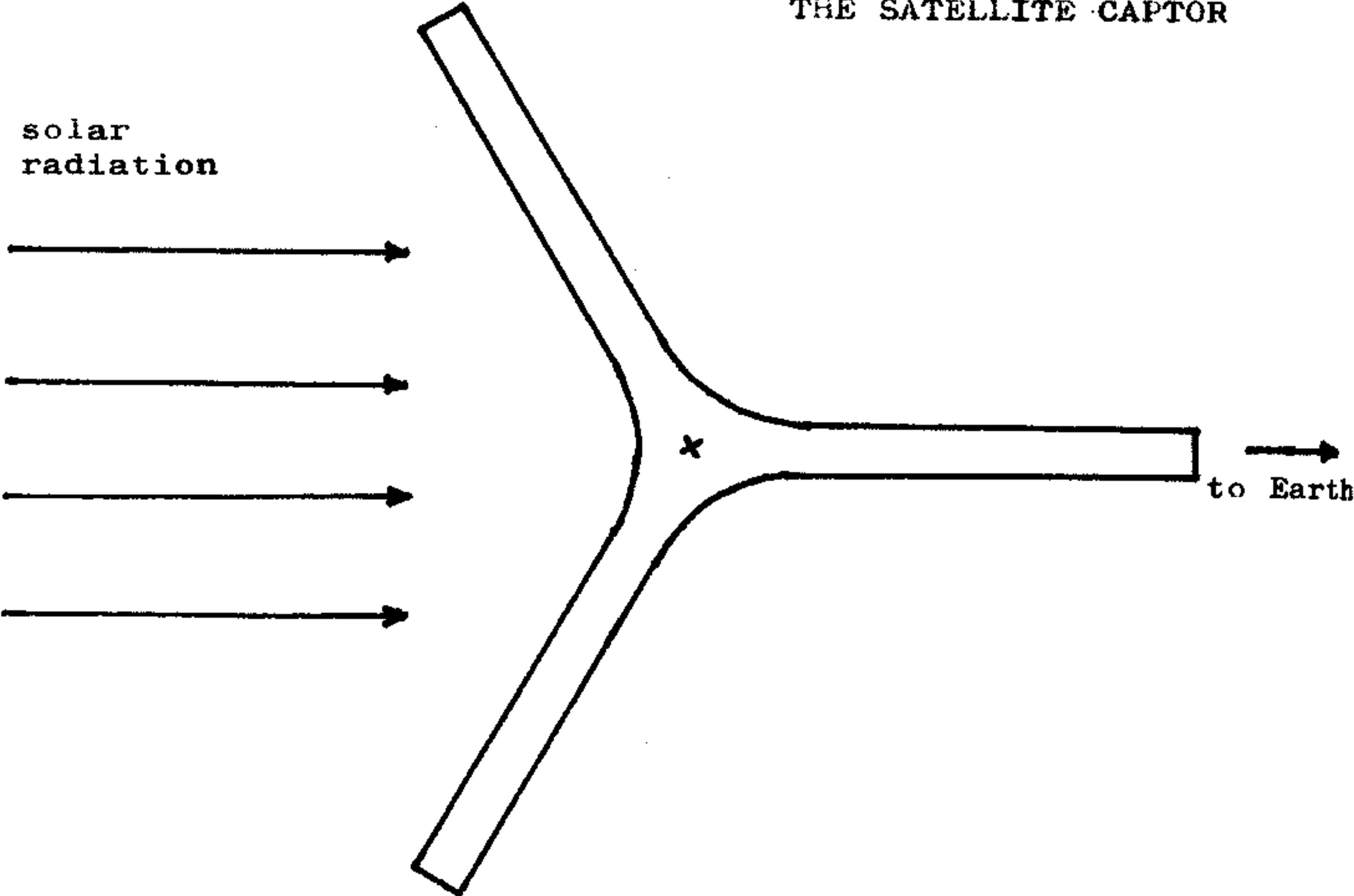

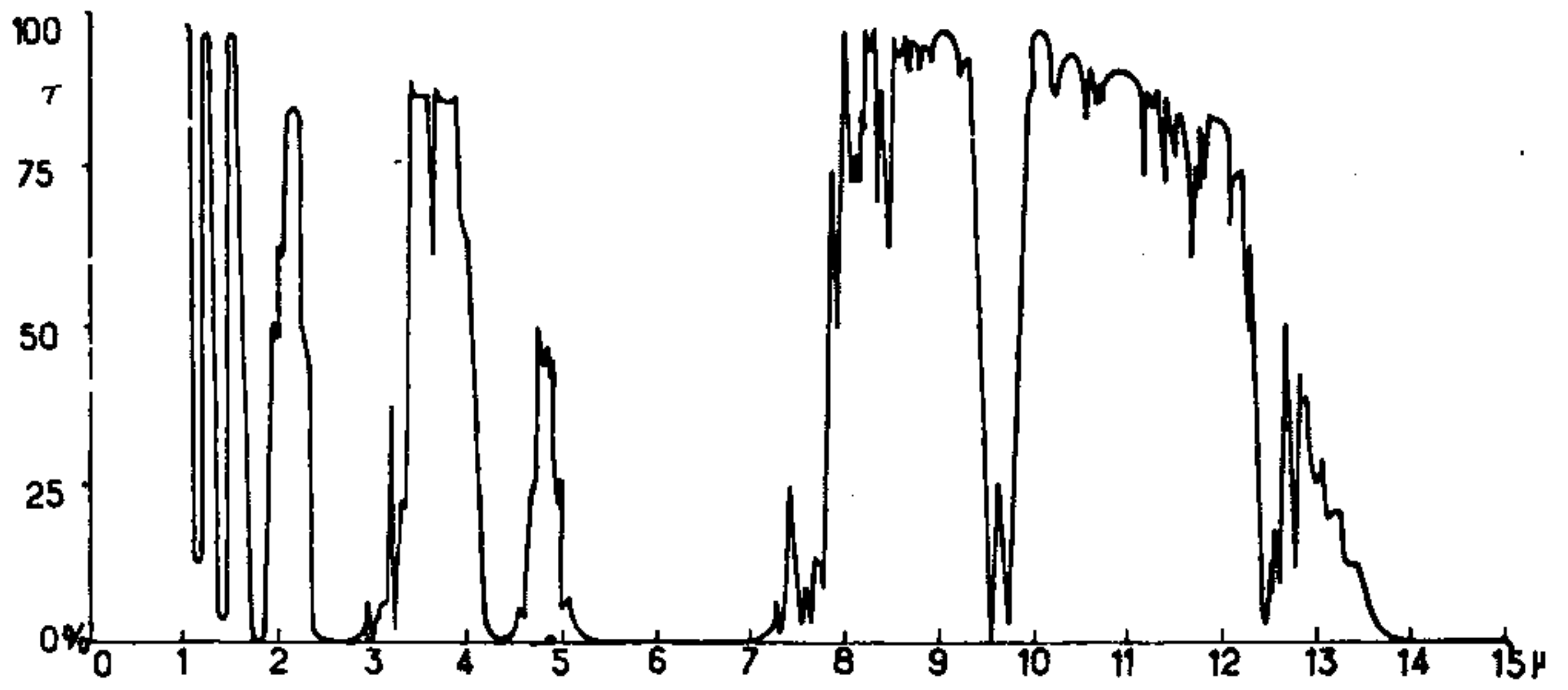

Atmospheric transmittance in terms of wavelength

SATELLITE POWER SYSTEM TOTAL PROOF-OF-CONCEPT PROGRAM
William V. McRae, Jr., Rockwell International
3322 South Memorial Parkway, Huntsville Alabama 35801

INTRODUCTION

During the past years of Satellite Power Systems (SPS) studies, major emphasis has been placed on identifying and resolving technical, environmental, societal, and economic issues which could seriously impact the feasibility, viability, and acceptability of an SPS program. Two years ago, sufficient effort had been conducted to show that the vast majority (e.g., 70%-85%) of these issues could be resolved by ground-based testing. To achieve this end, a relatively low-cost¹, four- to six-year Ground Based Exploratory Development (GBED) program was evolved to be conducted during the first half of the 1980's. From the mid-80's until the guided year 2000 for IOC of the first SPS, study of the remaining development program objectives centered around ensuring that hardware and manufacturing capability development schedules could be met and integrated within the time remaining before IOC. Upon review of these schedules and estimated funding demands within the context of decision-making requirements, it became obvious that a major conflict would ultimately surface. Basically, the problem encountered was that within the schedule constraints, a total program commitment needed to be made by the year 1990, yet adequate SPS proof-of-concept might not be accomplished until the mid-1990's. In an effort to resolve this conflict, Rockwell International undertook a brief in-house study to develop a program concept responsive to the needs of the decision-maker.

STUDY OBJECTIVES

The objectives of the Rockwell study were as follows:

- To define requirements for an early SPS orbital demonstration that could provide a system proof-of-concept within the 1980 decade sufficient to allow an SPS program commitment to be made in the year 1990.
- To develop a conceptual approach which would satisfy the defined requirements.

GUIDELINES AND CONSTRAINTS

The following guidelines and constraints were observed:

- Maximum use will be made of anticipated GBED program results.
- Earth launch system will be Space Shuttle Vehicle with current payload cargo bay limits and appropriate mass-to-orbit capabilities.

¹ If the development of every new hardware element required for the SPS were charged against the SPS programs, then the GBED phase would cost less than 1% of the overall development program costs.

SATELLITE POWER SYSTEM TOTAL PROOF-OF-CONCEPT PROGRAM

William V. McRae, Jr., Rockwell International
3322 South Memorial Parkway, Huntsville, Alabama 35801

SYSTEM DEMONSTRATION REQUIREMENTS

Fundamentally, a total system proof-of-concept entails component manufacturing, launch to orbit, space construction, and system operation measurable to a performance specification. More specifically, it must involve validation from orbit of key technology issues such as:

- Construction of large space structures
- Solar array performance
- Power amplifier performance
- Phase control system
- System pointing control
- Key subsystems interface performance
- Microwave beam forming
- Microwave environmental interactions
- Rectenna system performance
- Replication of system efficiency chain

Where deemed necessary, full scale system elements are to be employed. Note, however, that operational SPS system efficiencies are not required for all components in order to provide total system proof-of-concept. Funding for the demonstration must meet two basic requirements: First, the overall funding level must be reasonably low, and achieve results commensurate with the desired goals. Second, funding commitments must be very small during the early time frame of the GBED programs, and compatible with the GBED schedule.

DEMONSTRATION CONCEPT FINDINGS

The Rockwell effort, conducted within the bounds of demonstration objectives, guidelines, constraints and requirements, yielded a number of significant findings.

- System total proof-of-concept can be demonstrated with a satellite at low earth orbit.
- A microwave antenna structure of full SPS scale can be constructed on orbit.
- The concept shown in Figure 1 will duplicate all key interfaces of the operational SPS efficiency chain.
- Power collection can be demonstrated by a transportable rectenna farm of approximately half an acre in area (half the playing area of a football field).
- First-order cost estimates of the proof-of-concept demonstration at low earth orbit - including launch systems, space support systems, satellite systems, ground systems, and production facilities - might be achieved at a cost of ~\$800 M (in 1979 dollars). Major funding for the demonstration is not required until the late 1980's, i.e., until after completion of the GBED program.

SATELLITE POWER SYSTEM TOTAL PROOF-OF-CONCEPT PROGRAM
William V. McRae, Jr., Rockwell International
3322 South Memorial Parkway, Huntsville, Alabama 35801

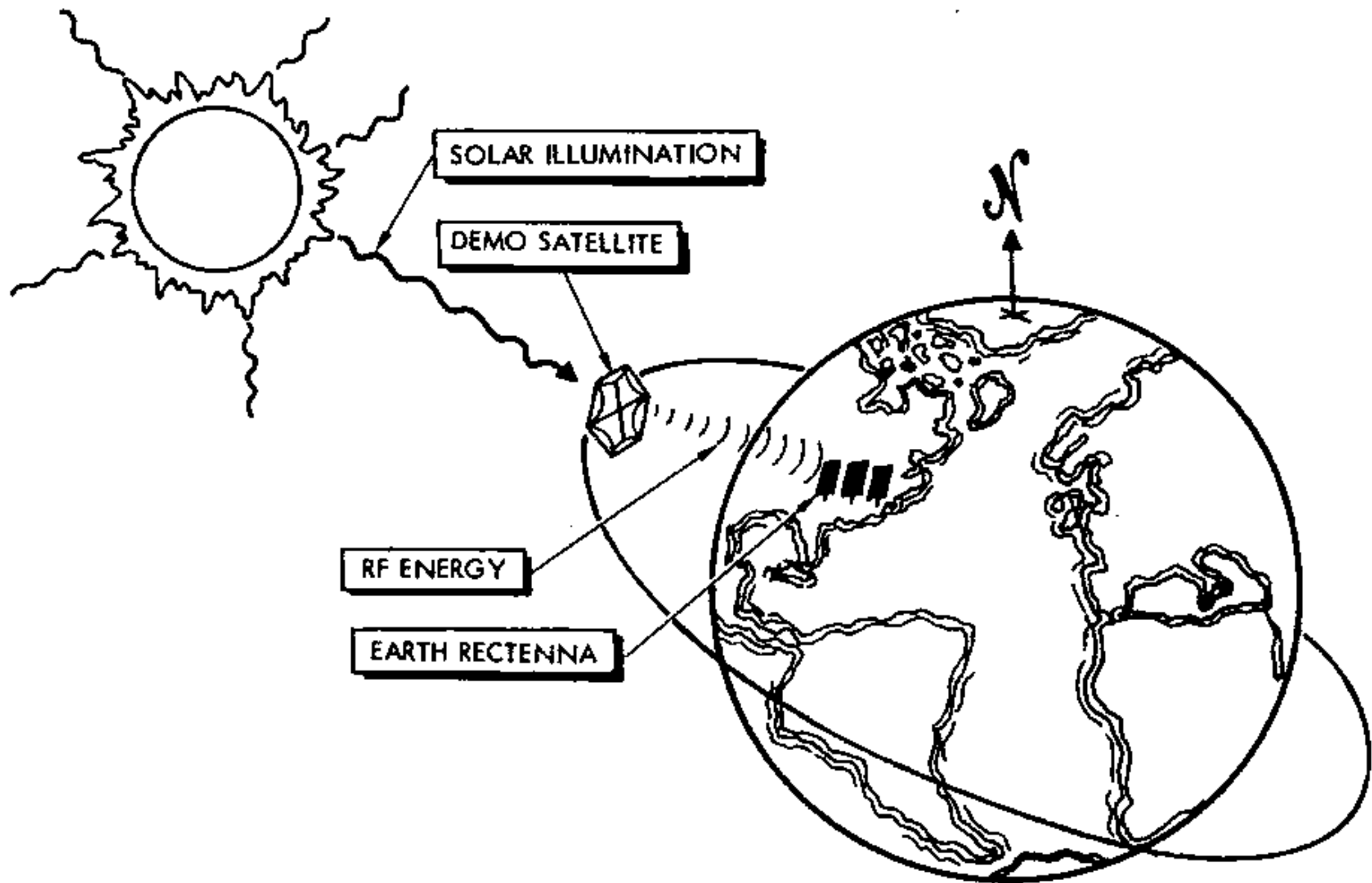

Figure 1. SPS Total Proof-of-Concept Demonstration

- As conceived, the demonstration system can be upgraded in stages to an operational system providing from one-half to a full GW of power at a utility interface.

POWER CONVERSION PERSPECTIVE
L. W. Brantley
Nasa/Marshall Space Flight Center, Alabama

The power conversion system considered for the SPS include the Photovoltaic, the Solar Thermal and, recently, the Solar Laser Systems. The key trade issues being compared among these systems are performance, resource availability, producibility, lifetime, cost, technology requirements and risks. The papers presented in this session address these issues.

The performance growth of space power systems required between now and the time the SPS is deployed is illustrated in Figure 1. About three orders of magnitude growth in power level is required each decade between 1980 and the year 2000. Figure 2 illustrates the improvements required in each parameter of the power system to meet the SPS challenge.

SATELLITE POWER SYSTEM POWER TECHNOLOGY GROWTH PROJECTIONS

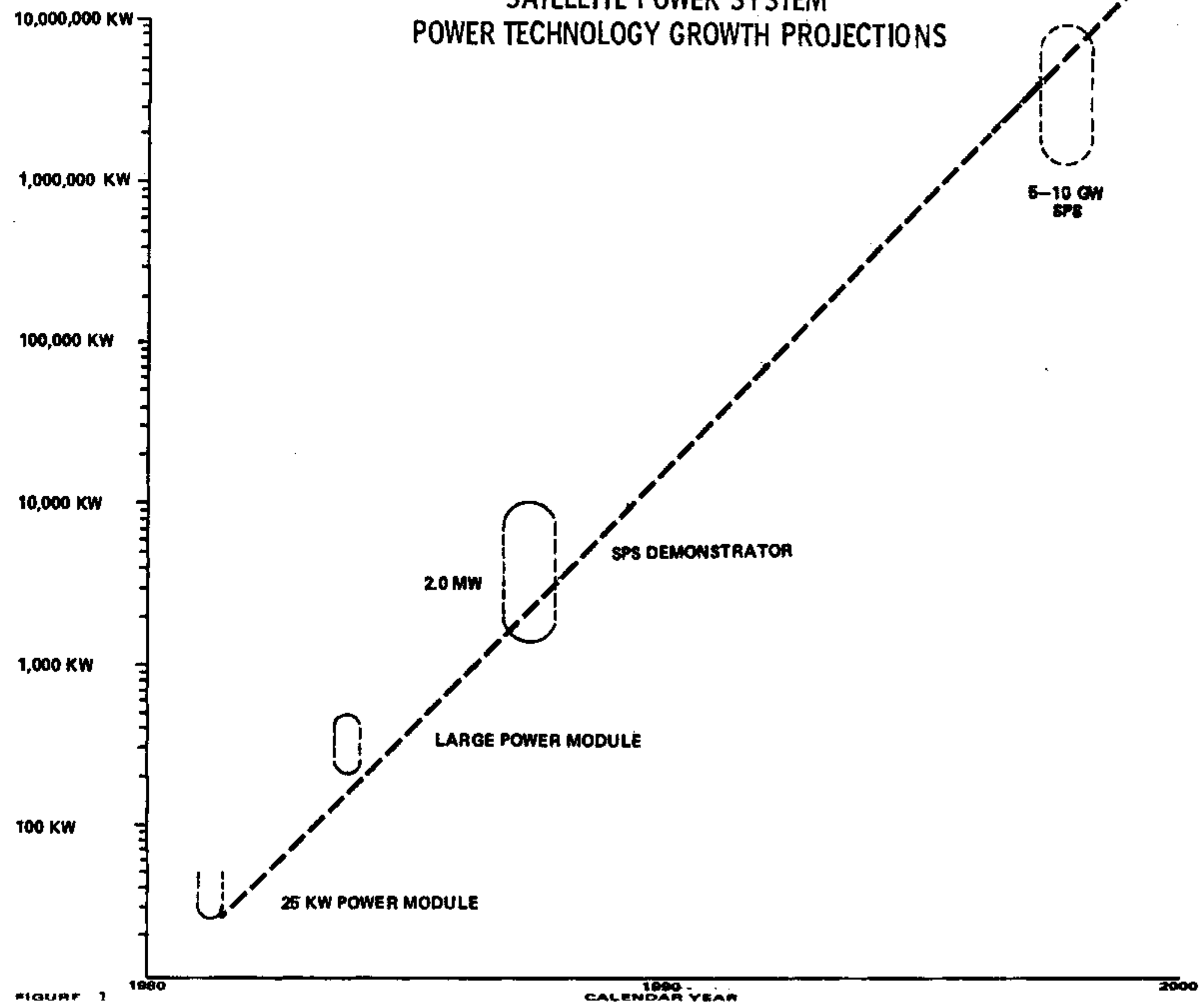
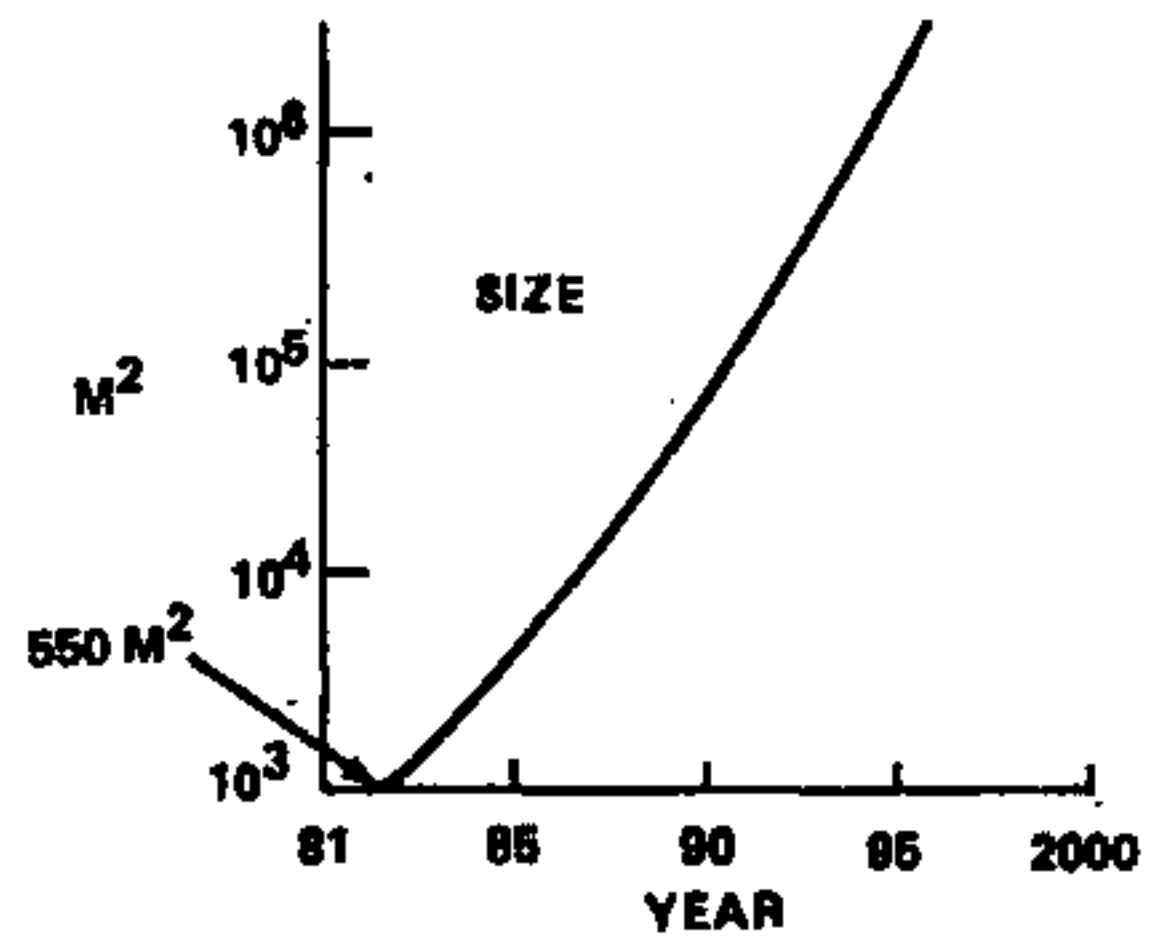
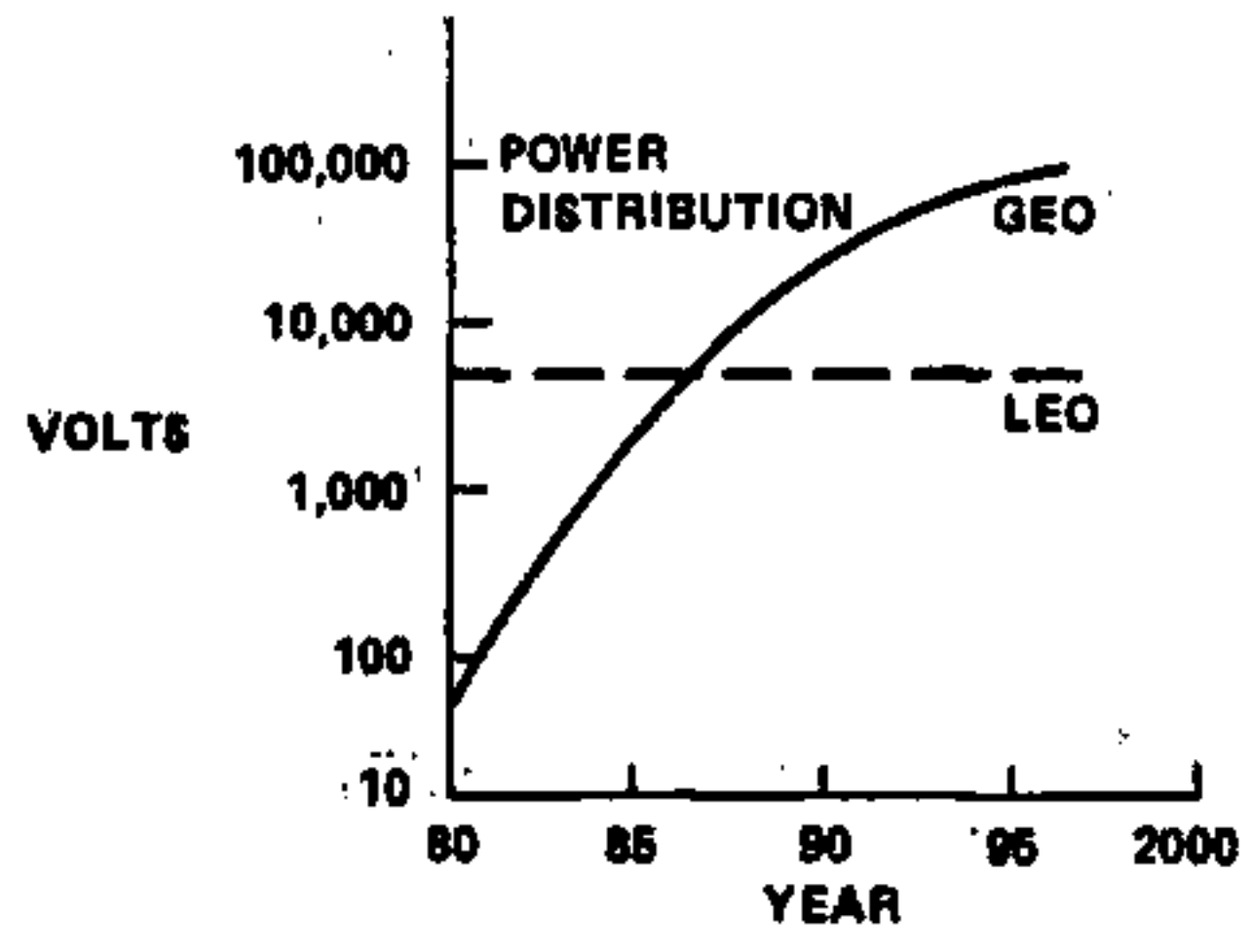
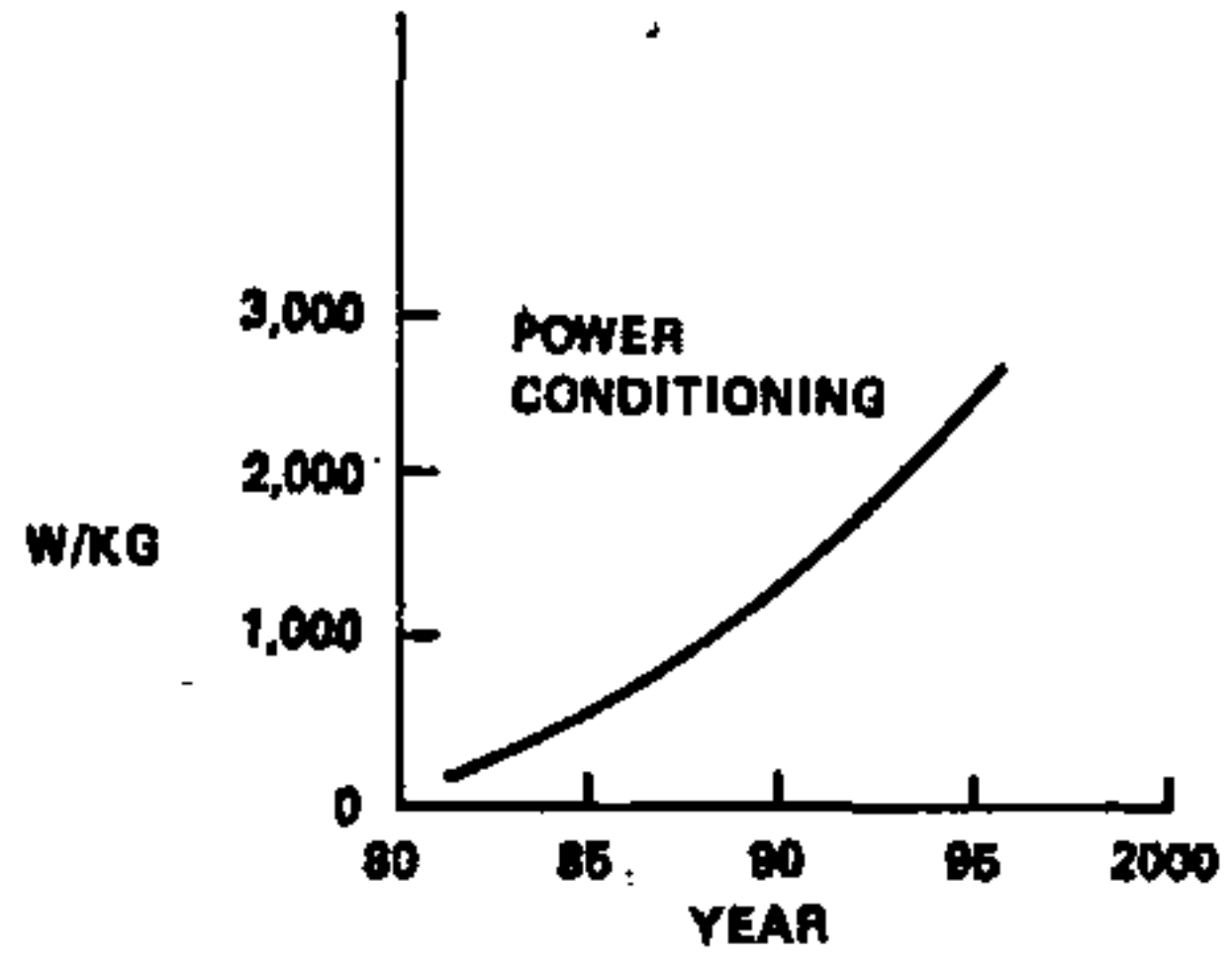
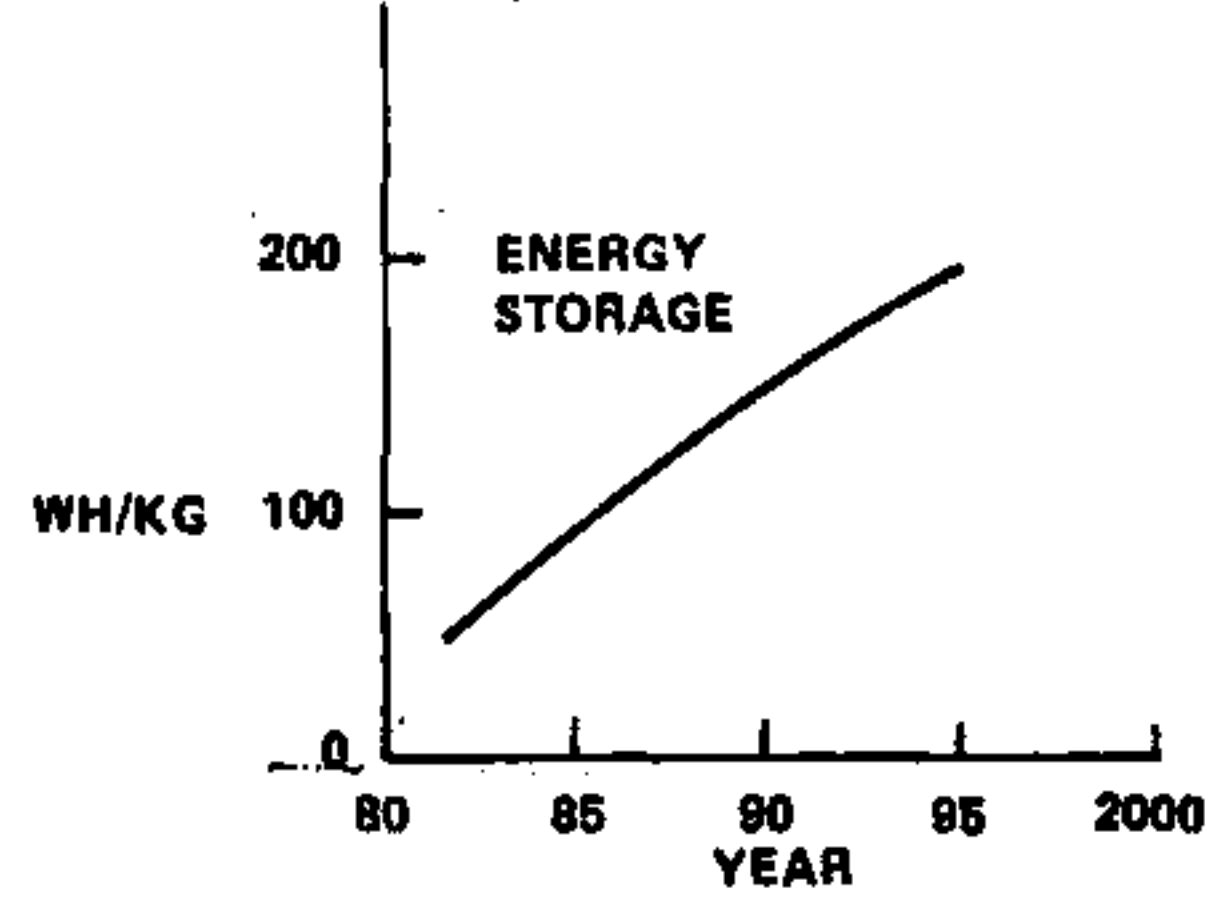
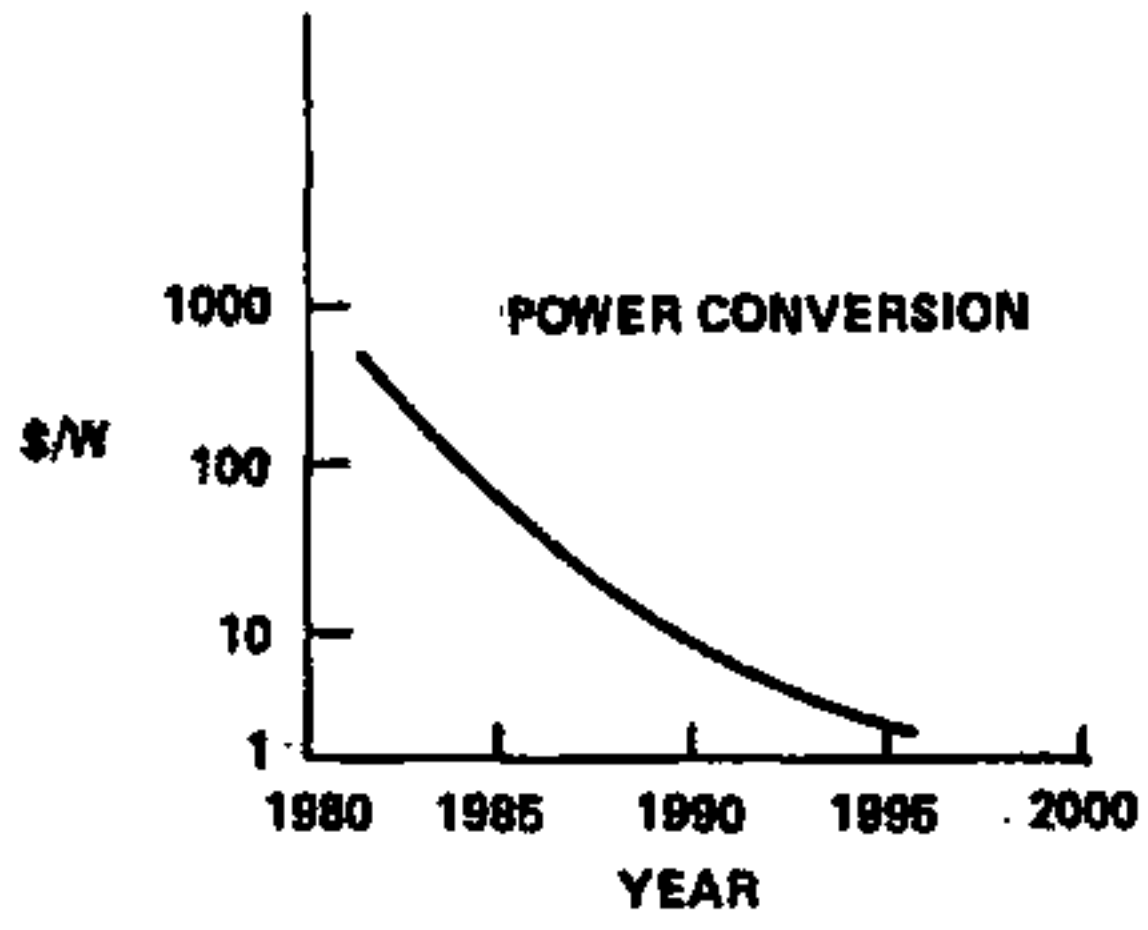

FIGURE 1

244

TECHNOLOGY ADVANCEMENT REQUIRED



245

FIGURE 2

GALLIUM ARSENIDE (GaAs) POWER CONVERSION CONCEPT

A.A. Nussberger, Rockwell International
12214 Lakewood Boulevard, Downey, CA 90241

The Rockwell Satellite Power System concept utilizes gallium arsenide (GaAs) solar cells and flat plate concentrators (CR=2) to generate 9.52 GW of power at the array sufficient for the satellite microwave antenna system to deliver 5 GW at the utility interface. The solar array bay configuration and design factors are shown in Figure 1. This concept shows a 3-bay by 10-bay matrix 3,900 m wide by 16,000 m long exclusive of the antenna. Each bay contains two panels 600 m by 750 m, providing a voltage string of 45.7 kV. The 600-m width consists of 24 rolls each 25-m wide.

The solar array is sized for worst conditions using summer solstice values (1311.5 W/m^2), end of life reflector values (CR effective = 1.83), solar cell degradation allowance (4% non-annealable loss), operating temperature of 113°C at summer solstice (solar cell temperature coefficient of $\Delta\eta/\Delta T = 0.0282\%/^\circ\text{C}$), north-south seasonal inclination (altitude tipping of the SPS configuration accounts for 9.05° of the nominal misorientation of 23.5° , resulting in a seasonal factor of 0.968), packaging and array voltage mismatch factor of 0.89, and switch gear factor of 0.997. Array power output is calculated to be 352.6 W/m^2 . The solar cell array area of $27 \times 10^6 \text{ m}^2$ provides a 1.7% margin.

Key functional requirements include: delivery of 5 GW at constant power (except during solar eclipse) to the utility network; operation in geosynchronous orbit for 30 years (size for end of life); and cost-competitiveness with ground-based power generation. The last requirement (cost competitive with ground-based power generation) has driven the Rockwell design toward use of higher technology hardware.

The solar cell used in the satellite system design is a GaAs cell having a nominal efficiency of 20% (AMO, 28°C). Based on today's technology, 20% cell efficiency is expected by the year 1990. The best laboratory GaAs cells are presently around 18% (Hughes, Rockwell International). The basic SPS cell concept is an inverted GaAs/sapphire design having a specific mass of 0.252 kg/m^2 (Figure 2). This cell design has a $20 \mu\text{m}$ sapphire (Al_2O_3) substrate upon which is grown a $5 \mu\text{m}$ single crystal GaAs junction. The Electronic Research Center (ERC) of Rockwell has supported this effort with investigations of the development and mass producibility requirements of the baseline GaAs/ Al_2O_3 cells using a metallic oxide-chemical vapor deposition (MO-CVD) process. Figure 3 shows a production model of inverted structure GaAs/ Al_2O_3 continuous ribbon solar cell. Trade studies by Rockwell on the system level have shown GaAs to be the preferred cell material compared to silicon. This is based on its higher efficiency (20% versus 17.3%); potential for cell efficiency improvements (the multi-bandgap concept is essentially a gallium arsenide cell with potential of 25-30% or greater); lower space radiation degradation damage (125°C threshold temperature for annealing versus $>500^\circ\text{C}$); lower specific mass (0.252 kg/m^2 versus 0.427 kg/m^2); better compatibility with concentrators (improved temperature coefficient, $\Delta\eta/\Delta T = 0.028\%/^\circ\text{C}$ versus $0.043\%/^\circ\text{C}$); and lower overall SPS cost.

A comparison of GaAs solar cell annealing effects after proton irradiation is presented in Figure 4. Over 400 small-area (0.4-cm-square) solar cells were tested by Rockwell.¹ Both typical and best cell annealing results are shown in Table 1. The SPS design assumes that nearly all radiation damage can be self-annealed out or annealed out with sufficient time and proper temperature.

A cost comparison was made of single-crystal GaAs, single-crystal silicon (Si), and amorphous silicon (A-Si). The baseline GaAs configuration was utilized at a mass of 0.252 kg/m^2 , the single-crystal silicon cell stack configuration was taken from the DOE/NASA reference system report² 0.427 kg/m^2 , and an amorphous silicon configuration was modeled from an RCA paper.³ It was assumed that the A-Si cell stack weight was equivalent to 1-mil glass (0.143 kg/m^2) and that the blanket configuration was the same as in the baseline GaAs. Figure 5 summarizes results and shows that A-Si must achieve near theoretical efficiency ($\sim 15\%$) and low cell cost ($\sim \$20/\text{m}^2$) to provide a cost-competitive SPS system. Single-crystal silicon (even at the high efficiency of 17.3%) appears to result in a significantly higher SPS cost ($\Delta \text{cost} \sim 2.13 \text{ B}$) compared to the GaAs CR=2 baseline.

¹Gallium Arsenide Solar Concentrator Hardness Study, Rockwell International, Technical Report AFAPL-TR-78-30 (May 1978).

²Concept Development and Evaluation Program, U.S. Department of Energy and NASA Reference System Report (October 1978).

³Twelfth IEEE Photovoltaic Specialist Conference, p 893.

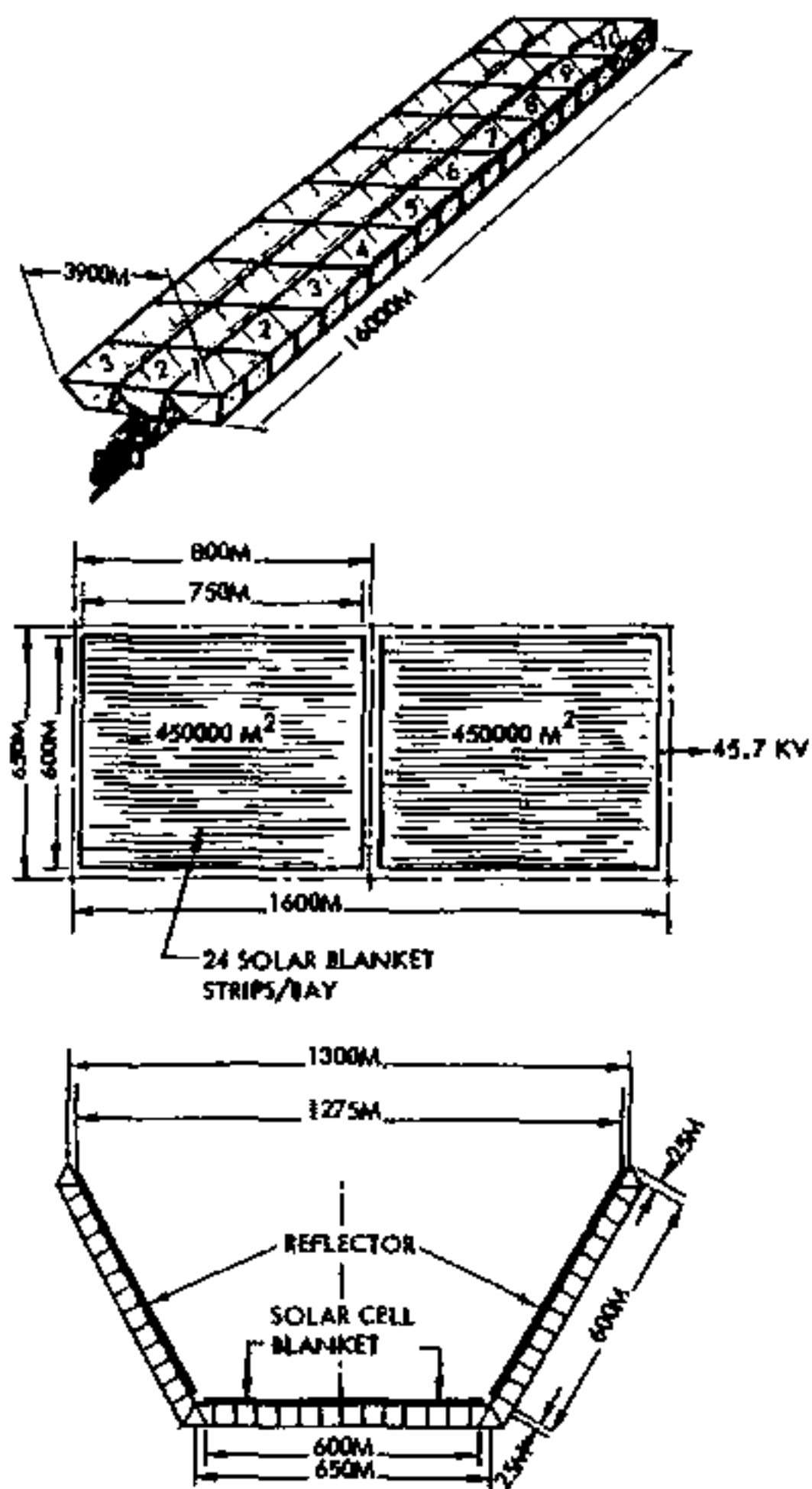

SOLAR ARRAY DESIGN FACTORS

SOLAR INPUT	1311.5 WATTS/M ²
ENERGY ONTO CELL (CR = 1.83)	2400.1
OPERATIONS TEMPERATURE	113 C
n(T)	435.9
DESIGN FACTOR (0.89)	387.9
SEASONAL FACTOR (0.968)	375.5
DEGRAD. FACTOR (0.96)	360.5
SG FACTOR (0.997)	359.4
MARGIN (0.983)	352.6

SOLAR ARRAY POWER OUTPUT = $352.6 \text{ W/M}^2 \times 27.0 (10^6) \text{ M}^2$
 = 9.52 GW

Figure 1. Solar Array Configuration

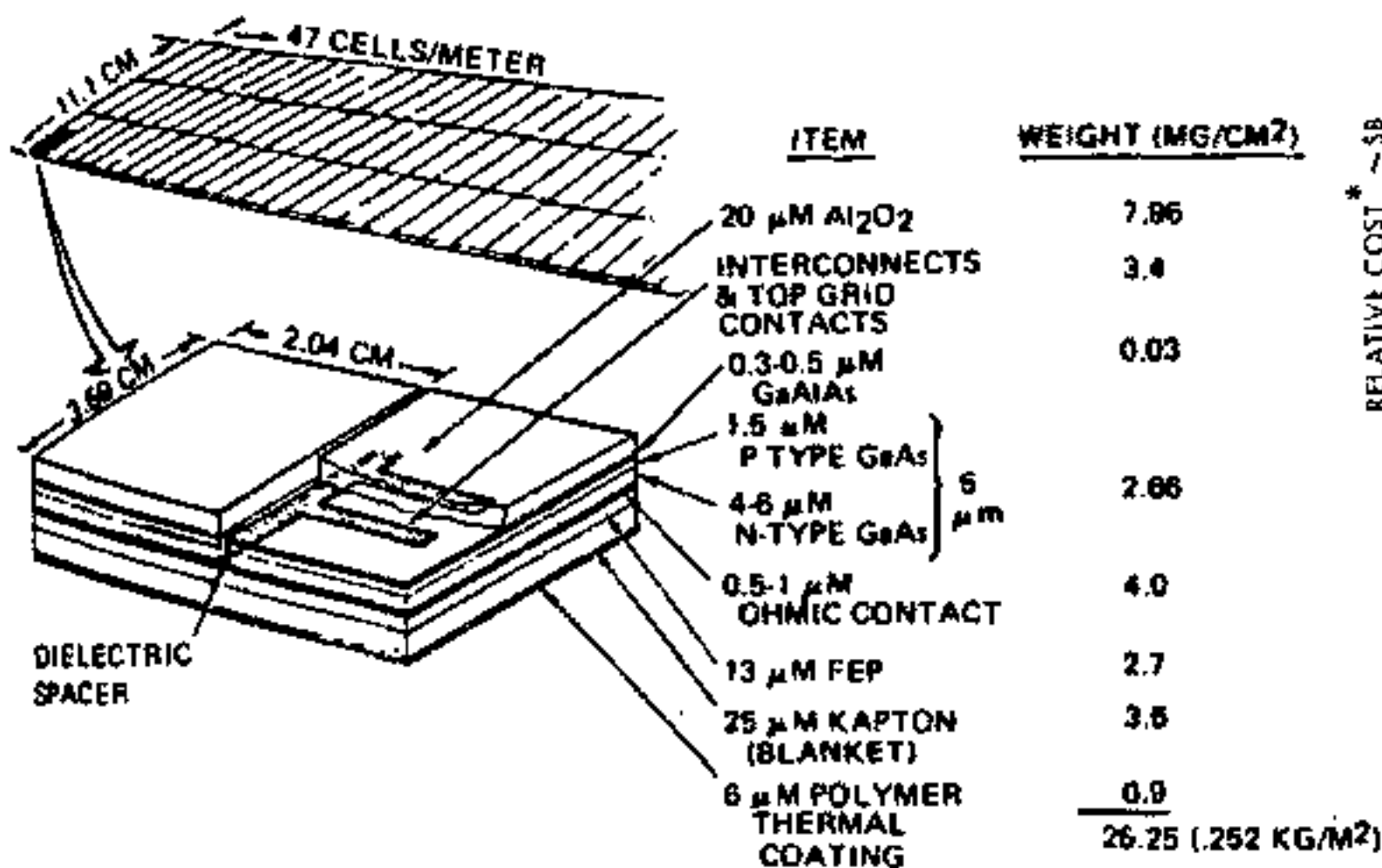

Figure 2. GaAs on Sapphire Solar Cell Blanket Cross-Section

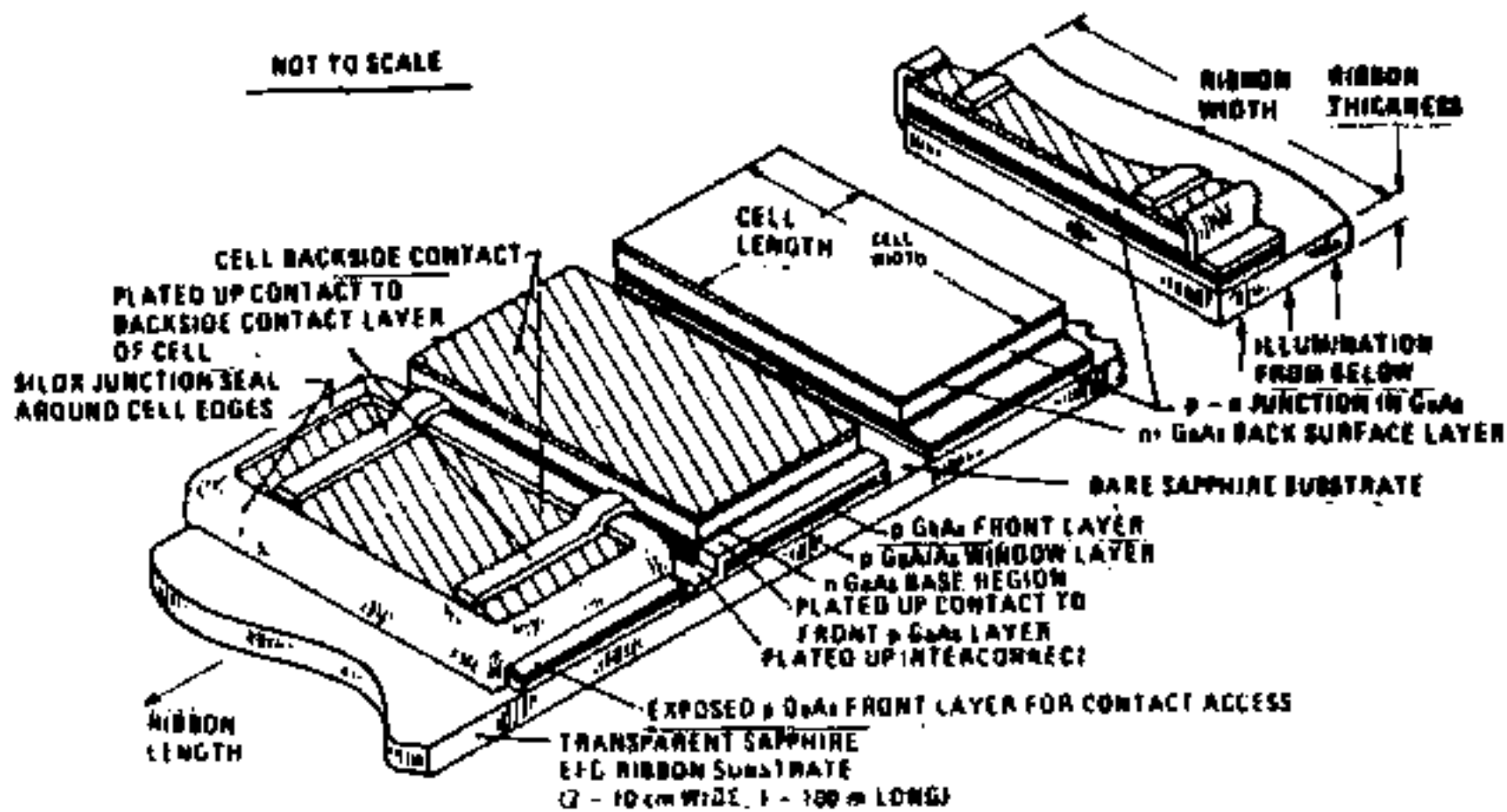
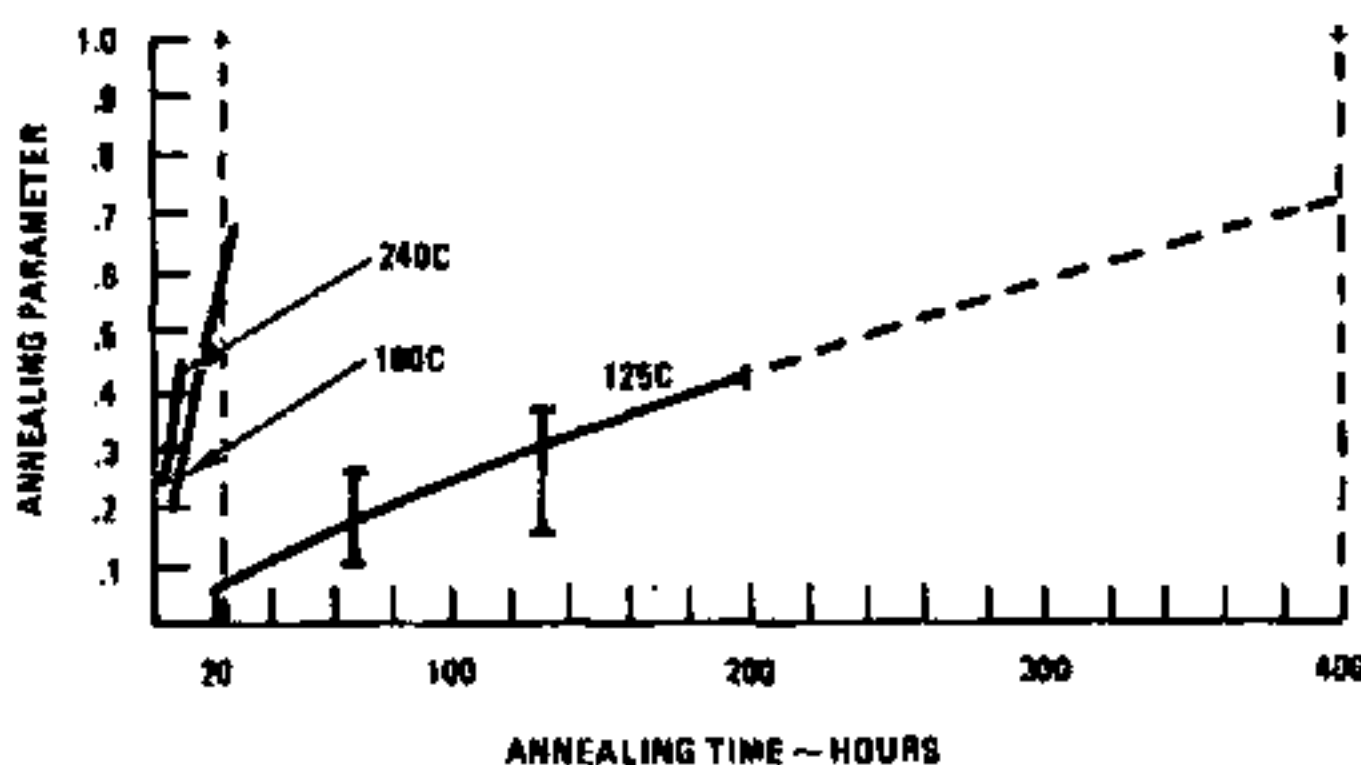

Figure 3. Production Model Inverted Structure GaAs/Al₂O₃ Continuous Ribbon Solar Cell



ANNEALING PARAMETER

$$\frac{P_A - P_R}{P_I - P_R} = (1 - e^{-t/\tau})$$

P_A = POWER AFTER ANNEAL
 P_R = POWER AFTER IRRADIATION
 P_I = POWER INITIAL
 t = ANNEALING TIME
 τ = RECOVERY TIME
 f = RECOVERY FACTOR

Figure 4. GaAs Solar Cell Annealing Effects

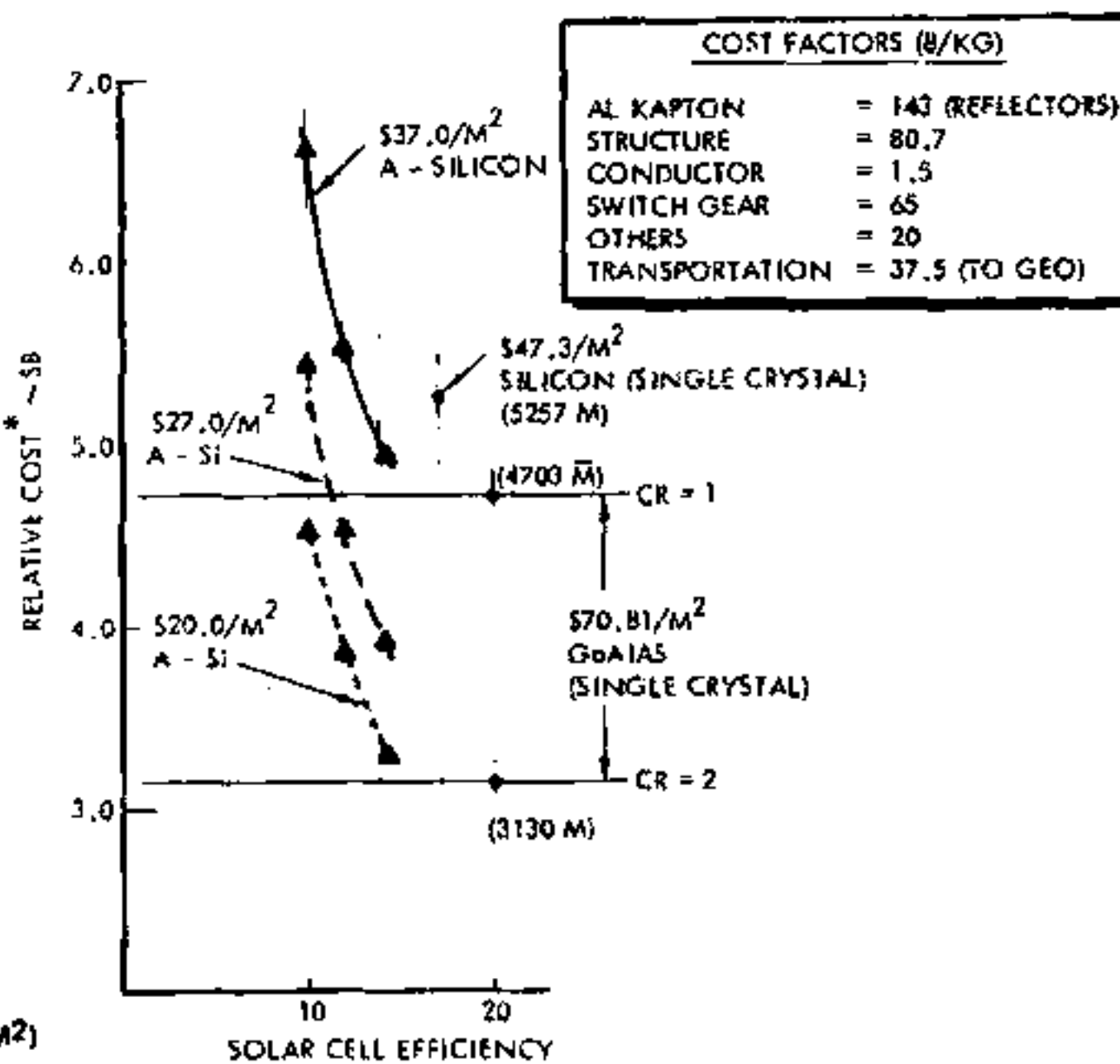

Figure 5. Solar Array Cost Comparison

Table 1. Proton Test Data

Test	Configuration*					
	1		2		3	
	Best	Typ	Best	Typ	Best	Typ
Initial						
Voc (V)	0.987	0.87	0.90	0.85	0.89	0.85
Isc (MA)	0.62	0.61	0.66	0.63	0.34	0.44
After Irradiation						
Voc (%)	98.6	93.7	98.5	96.0	68.1	64.0
Isc (%)	90.1	76.4	91.3	85.3	54.1	45.8
Recovery						
Voc (%)	99.3	97.2	99.2	97.8	83.6	73.1
Isc (%)	95.1	88.3	94.2	93.1	80.0	75.2
*Test Configurations:						
	1	2	3			
Radiation (protons/cm ²)	10 MEV (6.6x10 ¹⁰)	3 MEV (3.3x10 ¹⁰)	1 MEV (1x10 ¹²)			
Annealing Temp (°C)	130	130	180			
Annealing Time (hr)	65	65	17			

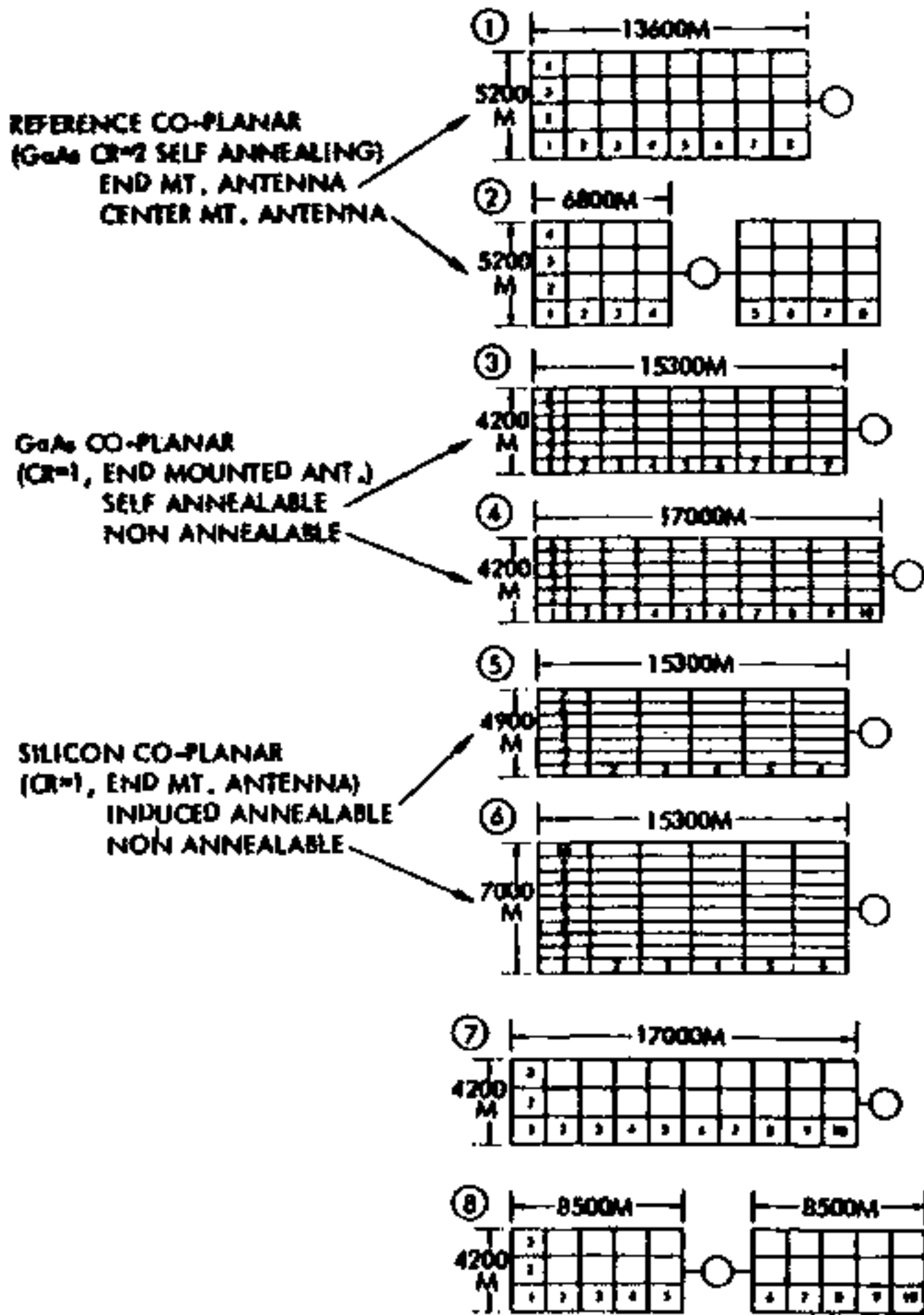

Figure 6. Configuration Options

Eight different satellite configuration options (Figure 6) were studied to obtain a better understanding of the impact of solar cell selection (GaAs versus Si), antenna mounting location (end versus center), number of troughs (range 3 to 10), concentration ratio (CR=2 versus non-concentrated), and radiation degradation assumption (annealable versus non-annealable). For these studies, solar cell and power distribution efficiencies were held constant, as was antenna mass. The data are summarized in Table 2.

Very little SPS mass difference was calculated between configurations with different numbers of troughs; however, construction considerations strongly favor a narrow configuration. A relatively small mass savings is indicated for a center-mounted antenna (0.4 kg/kW_{UT}); similarly, a relatively small difference in mass was shown between GaAs annealable and non-annealable CR=1 configurations (0.36 kg/kW_{UT}) and between GaAs CR=1 and CR=2 (0.89 kg/kW_{UT}).

Figure 7 shows a plot of SPS mass estimates made over the last few years. A mass curve was prepared which normalized to an early estimate made by Dr. Peter Glaser in 1974 (~2.3 kg/kW utility power). As shown, SPS mass estimates have grown by a factor of approximately 2.3 for GaAs configurations and 3.5 for Si configurations (NASA reference concepts). The GaAs concept falls near the nominal range of uncertainty established initially by NASA/JSC in-house studies conducted in 1975. Various alternative concepts are compared, including solid-state (SS) configurations which replace klystrons with solid-state power amplifiers for the dc to RF microwave system and multi-bandgap (MBG) solar cells replacing the reference GaAs single function cells. The impact felt by cell efficiency improvements is demonstrated by the MBG concepts, which use a 30% nominal cell efficiency.

GaAs solar array major technology needs for the SPS program are identified in Table 3. Assumed values are given for critical parameters used in the satellite concept definition. Impacts on the SPS design from a failure to achieve the design values also are given in the table. These technology requirements are to be addressed as part of the Ground-Based Exploratory Development (GBED) activities.⁴

Table 2. Configuration Comparison Data

CONFIGURATION	(1)	(2)	(3)	(4)	(5)	(6)	(7)	(8)	FIRST Q BASELINE
CELL MATERIAL	GeAs				Si		GeAs		
CONC RATIO	2		1				2		
ANT MOUNT	END	CENTER	END					CENTER	
RADIATION DEGRAD FACTOR	.96			.84	.96	.70	.96		
CELL OUTPUT (W/M ²)	362.7		218.2	190.9	182.9	133.4	362.7		336.6
SOLAR CELL AREA (10 ⁶ M ²)	28.4		47.2	53.95	56.3	77.2	28.4		30.6
REFLECTOR AREA (10 ⁶ M ²)	57.6						57.6		61.2
BAY DIMENSIONS (M)	700 X 1700				700 X 2550		750 X 1700		600 X 1400
NUMBER SOLAR CELL BAYS	4 X 8 = 32		6 X 9 = 54	6 X 10 = 60	7 X 6 = 42	10 X 6 = 60	3 X 10 = 30		3 X 12 = 36
REFL BAY DIMENSION (M)	1300 X 1700						1400 X 1700		1250 X 1400
PLAN FORM AREA (M ²)	5200 X 13600		4200 X 15300	4200 X 17000	4900 X 15300	7000 X 15300	4200 X 17000		3850 X 19200
PLAN FORM AREA (10 ⁶ M ²)	70.72		64.3	71.4	74.97	107.1	71.4		73.92
NO. SWITCHGEAR (ON ARRAY)	1120		1890	2100	2436	3480	1140		1260
COLLECTOR ARRAY (10⁴ KG)									
STRUCTURE & MECH	2.156		2.043	2.168	2.238	2.791	2.156		3.825
SOLAR PANELS	7.258		11.897	13.595	23.988	34.306	7.258		7.722
SOLAR REFLECTORS	1.182						1.182		1.108
POWER DISTRIBUTION	2.719	1.55	2.879	2.545	3.058	3.87	3.80	1.272	1.081
ATT CONTROL/IMS/ROT JT	.385		.350	.389	.408	.583	.385		.385
	(13.699)	(12.53)	(17.259)	(18.697)	(29.684)	(41.750)	(14.011)	(12.253)	(14.127)
ANTENNA SECTION	16.297								
SUBTOTAL	29.996	28.827	33.556	34.994	45.961	58.047	30.308	28.55	30.424
25% GROWTH	7.499	7.206	8.389	8.749	11.495	14.512	7.577	7.137	7.606
TOTAL	37.495	36.033	41.945	43.743	57.456	72.559	37.885	35.687	38.029

Table 3. SPS Solar Cell Parameters as Design Drivers

Parameter	SPS GaAs Design Values	Description	Impact on Design (failure to achieve values)
Cell efficiency	20% (AMD, 28°C)	SPS concept (CR=2) requires 27.0 x 10 ⁶ m ² of solar cells; array output: 352.6 W/m ²	Lower efficiency penalizes array area, weight, array cost, transportation cost, and construction schedule; Si performance could be as low as 123.6 W/m ²
Radiation degradation	4%	Non-annealable allowance is 4% array area; current design assumes self-annealing at >125°C	Failure to achieve annealing will penalize array area 16% in GEO and 40% EOTV; Si degradation penalties are greater
Weight	0.252 kg/m ²	Total SPS array weight = 7.536 x 10 ⁶ kg; ~25% of total satellite weight	Substitution of Si penalizes system by 22.2 x 10 ⁶ kg or more
Operating temperature	>125°C	GaAs performance at operating temperature: -17.6%	Lower performance could penalize system by forcing nonconcentrated SPS ~4.06 x 10 ⁶ kg; 18.8 x 10 ⁶ m ² solar cells
Cost	\$70.8/m ² solar cells	Total array cost \$3130.2M (basic cell/reflector cost \$2320M) per satellite*	Si cell cost penalty adds \$2126.7M to array cost*
Cell thickness	5 μm active GaAs region 20 μm sapphire substrate	Gallium requirement for SPS ~375 metric tons (5 GW)	Thicker materials affect weight, cost, and availability

*Reference: Satellite Power System (SPS) Concept Definition Study (Exhibit C) First Quarterly Review, Rockwell International, SD 78-AP-0075 (June 21-22, 1978)

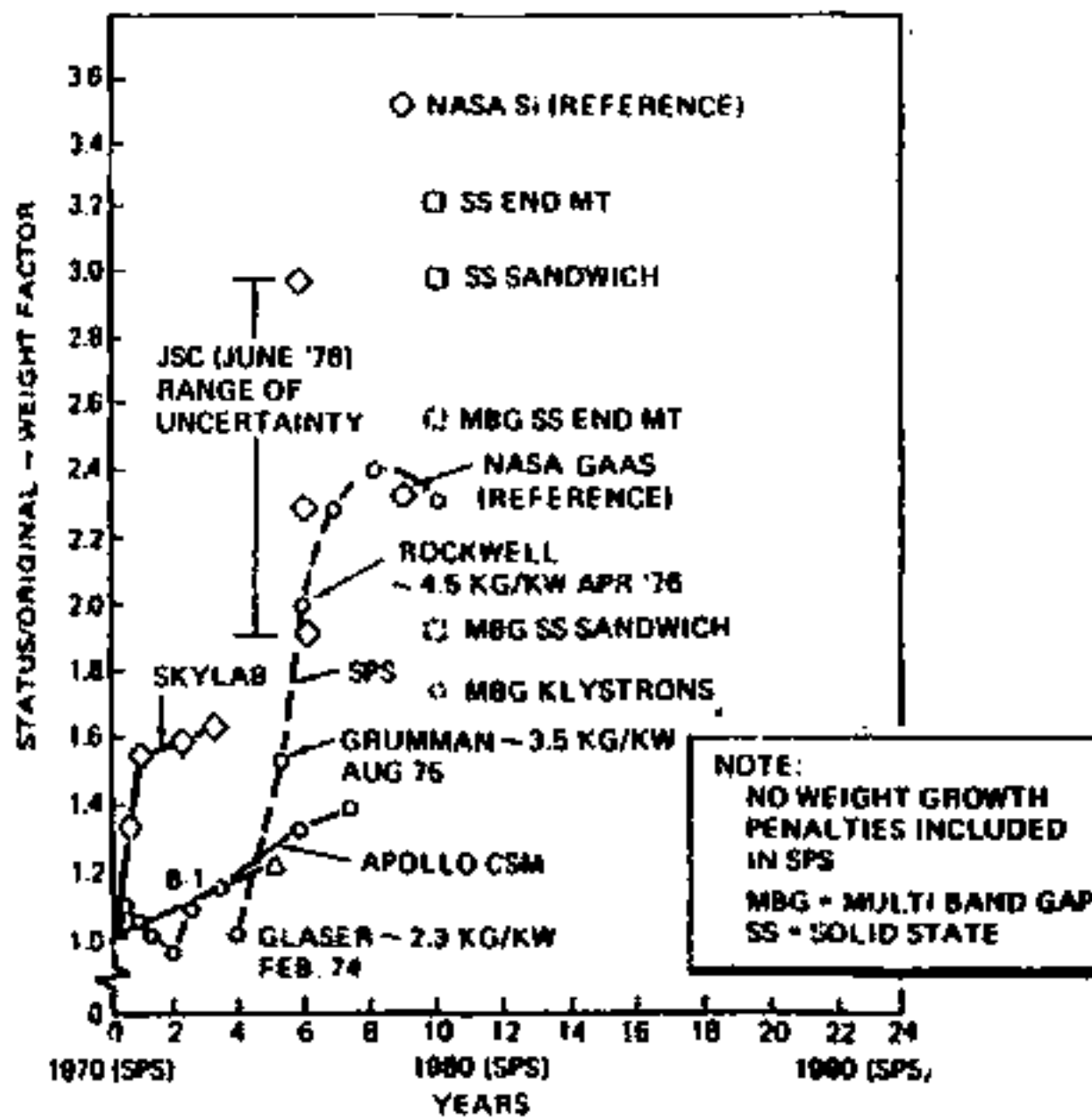

Figure 7. SPS Weight Uncertainty

⁴Satellite Power System Ground-Based Exploratory Development (GBED) System Analysis and Technology Plan, National Aeronautics and Space Administration, Rough Draft (December 1, 1979).

SPS SILICON REFERENCE SYSTEM

Gordon R. Woodcock
Boeing Aerospace Company
P.O. Box 3999, Seattle Wash 98124

The silicon reference SPS is one of two reference designs developed by the NASA Systems Definition Studies, the other being a Gallium Arsenide option. The JSC/Boeing study emphasized silicon and the MSFC/Rockwell study emphasized Gallium Arsenide. These two options provide a balance between a more mature, relatively well-understood photovoltaics technology and a more advanced one which offers performance advantages and possibly cost advantages.

The composite drawing of Figure 1 illustrates the main features of the silicon reference system. The solar array consists of glass-encapsulated 50-micrometer silicon solar cells, interconnected in series-parallel arrangement to provide the necessary voltage and cell failure redundancy. The array blankets are suspended in a space-frame cubic trusswork of 128 bays, each 667.5 meters square and 470 meters deep. A tension catenary system maintains the solar cell blanket in each bay adequately flat, with a "trampoline" natural frequency about twice that of the solar array support structure as a whole. The array area of 49.6 square kilometers generates 8766 megawatts (dc) electric power at 44 kV. This electric power is conducted by an arrangement of ten pairs of power busses to the electrical slip ring interface between the power transmitter. The transmitter converts the electric power to 6700 megawatts of radiated RF power at 2450 megahertz.

Details of the solar blanket are illustrated in Figure 2. The individual solar cells are about 50 square centimeters. The size was selected to be compatible with the electrical arrangement of the solar array depicted in Figure 3 and the number of cells in series (about 77,000) required to deliver the required voltage. The cells are encapsulated in panels roughly one meter square and the panels are interconnected by welded flexible tabs. Each panel incorporates a pair of shunting diodes to protect it from reverse voltage in the event of shadowing. Panels are mechanically interconnected by glass fiber tape and are folded or rolled in shipping containers for delivery to space.

Figure 3 also shows the general scheme for power distribution to the array-antenna interface. Sets of solar cell strings are connected to the satellite main busses at the 2000-amp level through sets of switchgear to provide fault protection as well as isolation of strings of cells for annealing. The main busses are 1-mm aluminum. Passively-cooled conductors of this nature become lighter as they are made thinner. The 1-mm figure provides reasonable minimum gauge and conductor width. The conductors are supported below the solar array by secondary structure.

Silicon solar cells degrade in the space environment as a result of ionizing radiation. The principal source of damage is solar protons from flare events. Prediction of the amount of degradation is complicated by the statistical nature of flare phenomena as well as by problems in extrapolating available proton spectral data to the 2 to 10-MeV energy range that will cause most of the damage. There is also some uncertainty in the amount of degradation to be expected at any given fluence as well as uncertainty in converting from test results (usually isoenergetic) to the solar proton spectrum. The Boeing studies used a generally pessimistic radiation model (more fluence than the expected value) and measured proton damage data for experimental 50-micrometer cells. The result was an estimate of 30% output loss for the silicon satellite at the end of a 30-year "book life" period. The reference system therefore includes an in-situ annealing system that would be used every few years to restore array performance. Characteristics of the annealing system were based on extrapolation of results of preliminary experimental laser annealing of proton-damaged 50-micrometer solar cells.

The interface between the solar array and transmitter consists of a support yoke, a mechanical turntable drive, and an electrical slip ring. The overall yoke arrangement was depicted in Figure 1. Figure 4 shows additional detail of the electrical slip ring. Twenty rings provide conductor paths for the ten pairs of busses. The slip ring diameter was minimized to the extent practicable considering the currents to be delivered, clearance for bus connections, and thermal control. The slip ring size allows it to be assembled and checked out on the ground and delivered to orbit intact aboard the reference Heavy Lift Launch Vehicle.

The power transmitter includes 101,552 high-efficiency Klystron power transponders each including phase control equipment and power control and data management support systems. The transponders conjugate and amplify the uplink phase control signal from Earth and return it to the point of origin as a power beam. Each klystron is individually phase-controlled to maintain precision beam control and high gain. Three levels of control are provided for beam steering: (1) Coarse mechanical pointing of the antenna by the turntable drive; (2) Fine mechanical pointing by antenna-mounted CMG's; (3) Ultra-fine electrical pointing by the phase control system. The CMG's are continuously desaturated by the turntable drive; the overall angular momentum control for the satellite is provided by electrical thruster systems at the four corners of the solar array.

The antenna power intensity is tapered over the aperture to provide high power transfer efficiency and low sidelobes. The taper ranges from a maximum of 22 kW per square meter at the center of the antenna to 1/9 of this value at the edge, as schematized in Figure 5. The Klystron transponders are assembled into subarrays 10.4 meters square. The subarrays include the slotted waveguide radiators, distribution waveguides, thermal control equipment, phase control equipment, support structure, and data and control systems. They are designed to be assembled and tested on the ground prior to shipment to space. Most of the electronic complexity of the power transmitter is within the subarrays, thus most of the electronic integration can be done on Earth.

Power supplied to the Klystrons must be partially processed. About 85% of the power can be provided unconditioned from the solar array with only breaker protection. The balance is processed by substations located at the back of the power transmitter. Figure 6 is a preliminary concept of such a substation. The size of the individual processors was selected so that outage of a single processor (and the Klystrons it supplies) will not significantly disturb the power beam pattern.

Satellite configuration control and data management are provided by a triply-redundant communications system interconnected with a redundant, hierarchical, distributed-processing computer network. Triple redundancy of computers is also provided for critical functions such as flight control. All data and communications interconnects employ fiber optics in order to minimize interference from the satellite electrical and RF power systems.

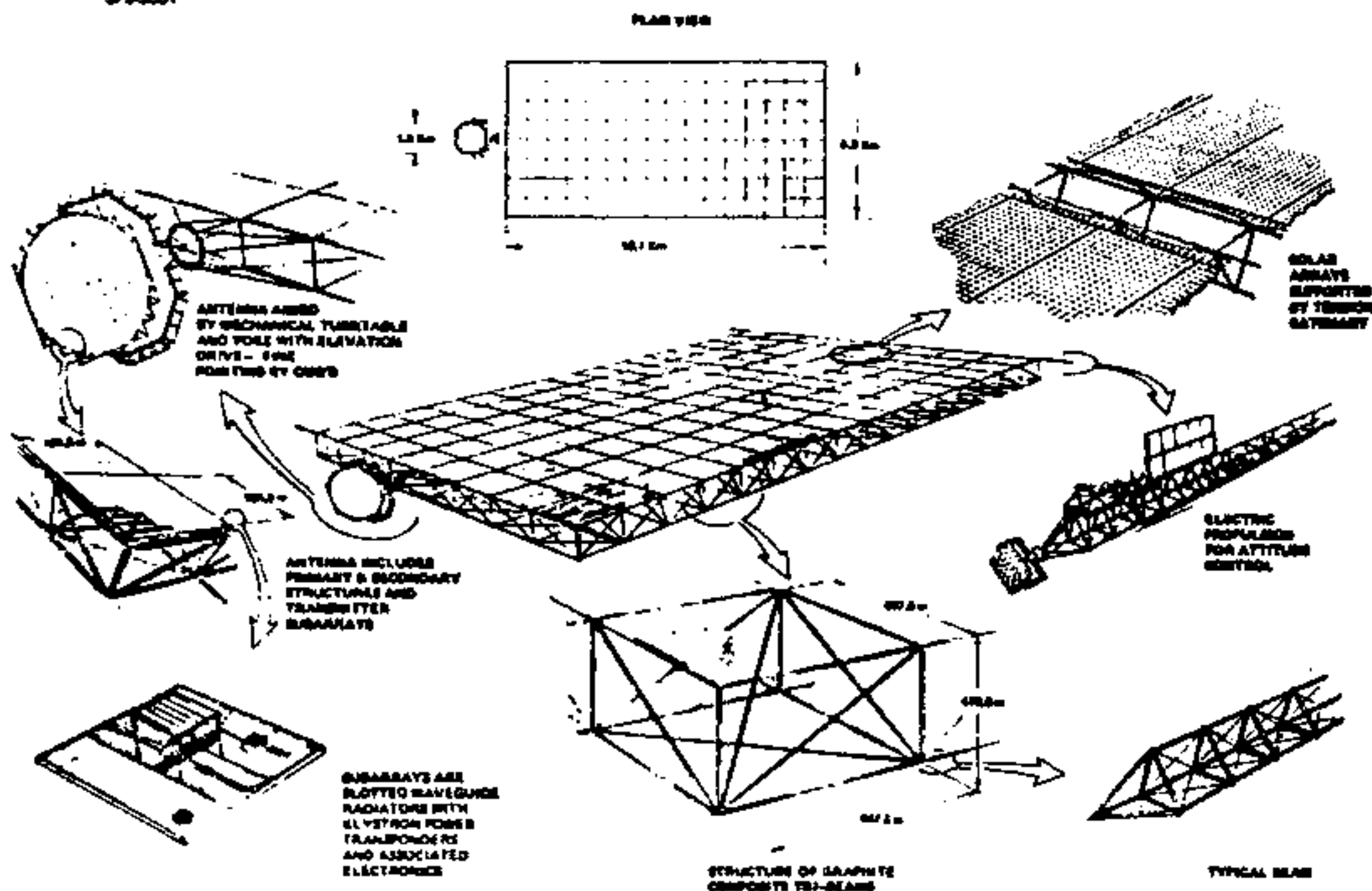

Figure 1- SPS SILICON SOLAR ARRAY REFERENCE DESIGN CONCEPT

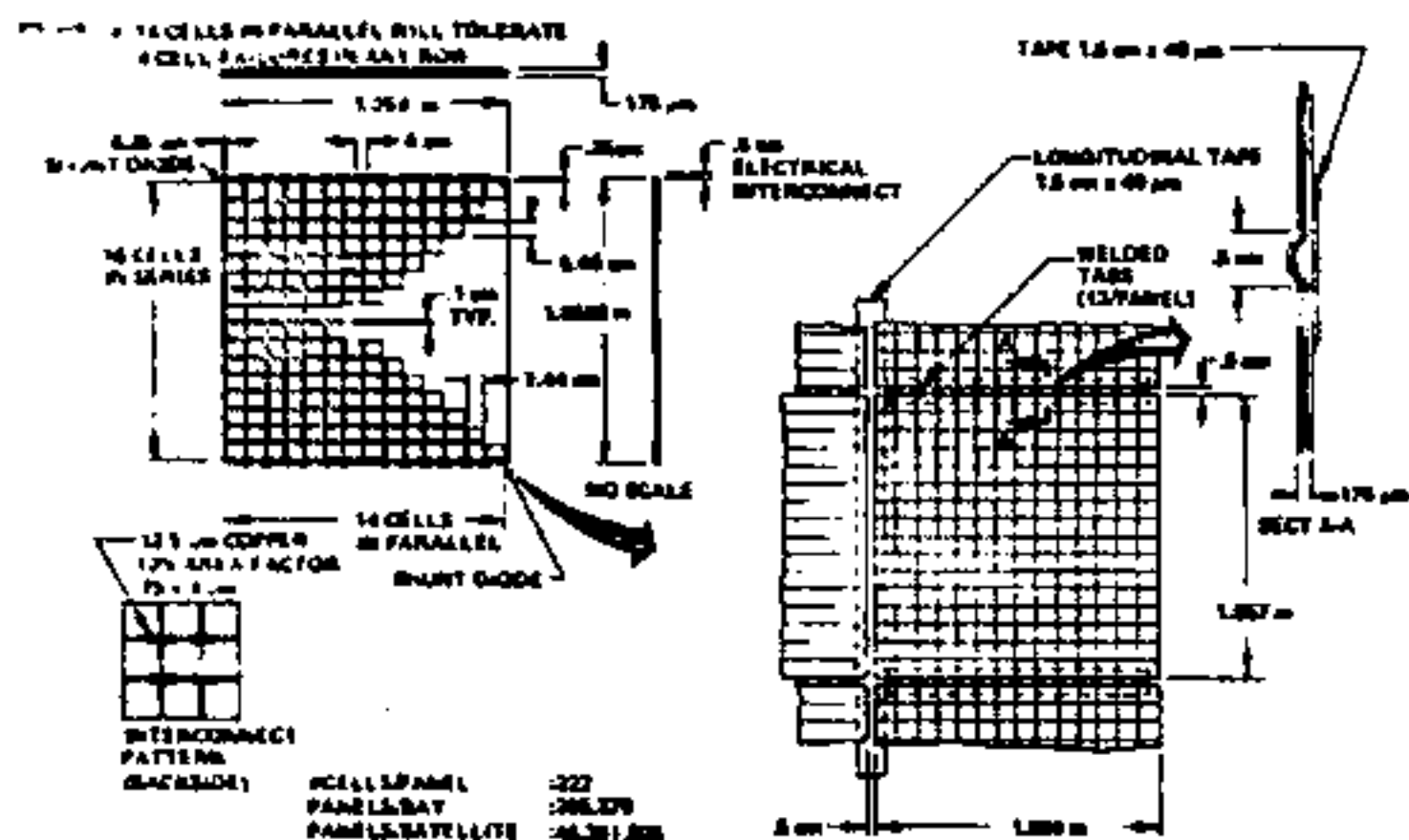

Figure 2- REFERENCE PHOTOVOLTAIC SYSTEM DESCRIPTION

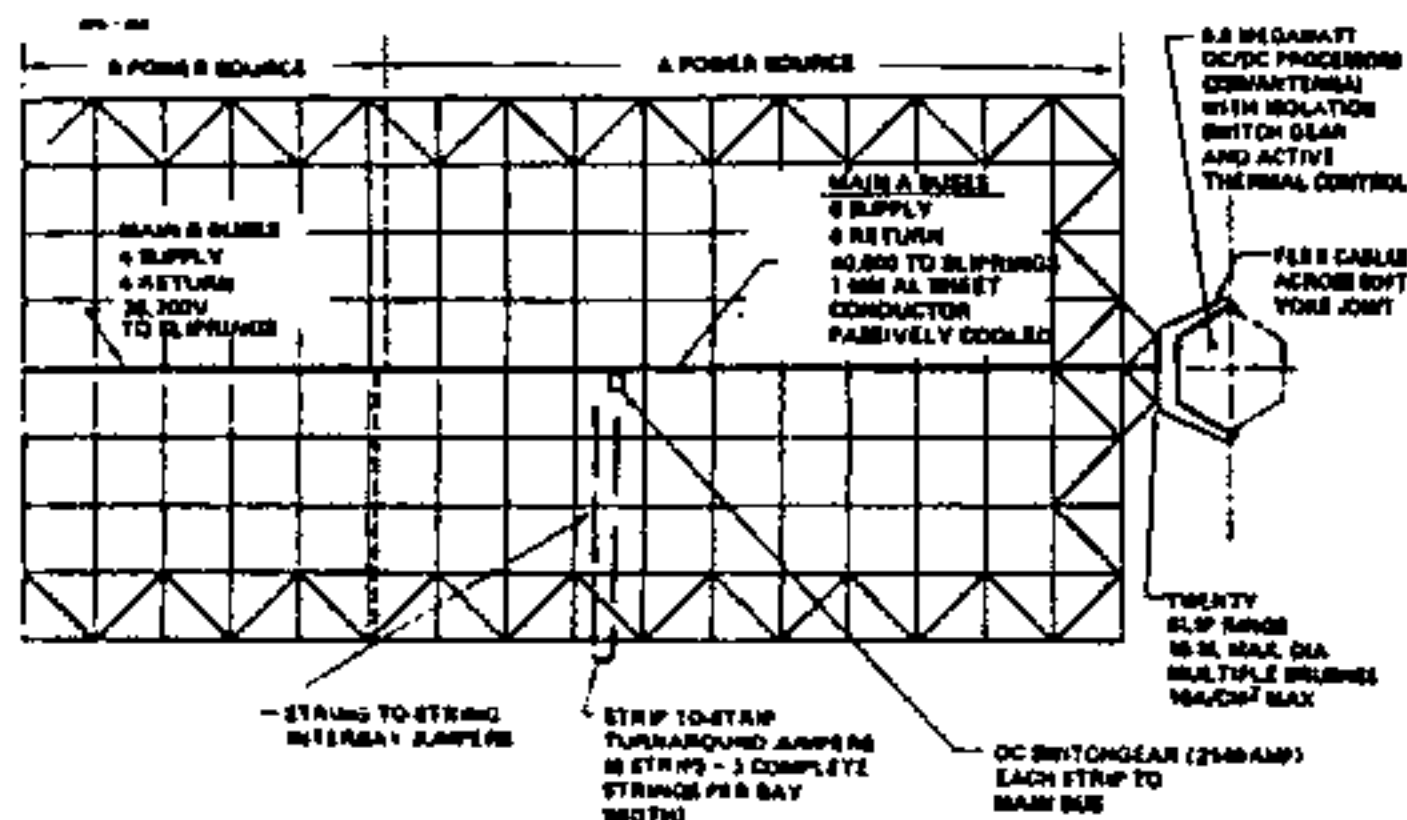

Figure 3- MULTIPLE BUS SPS POWER DISTRIBUTION

● SEVERAL COMPONENTS REQUIRE PRODUCTION RATES GREATER THAN PRESENT CAPABILITY

- SOLAR BLANKETS
- GRAPHITE STRUCTURE
- KLYSTRONS
- ELECTRIC THRUSTERS
- LIQUID HYDROGEN

● ONLY SOLAR BLANKETS REPRESENT A PROBLEM

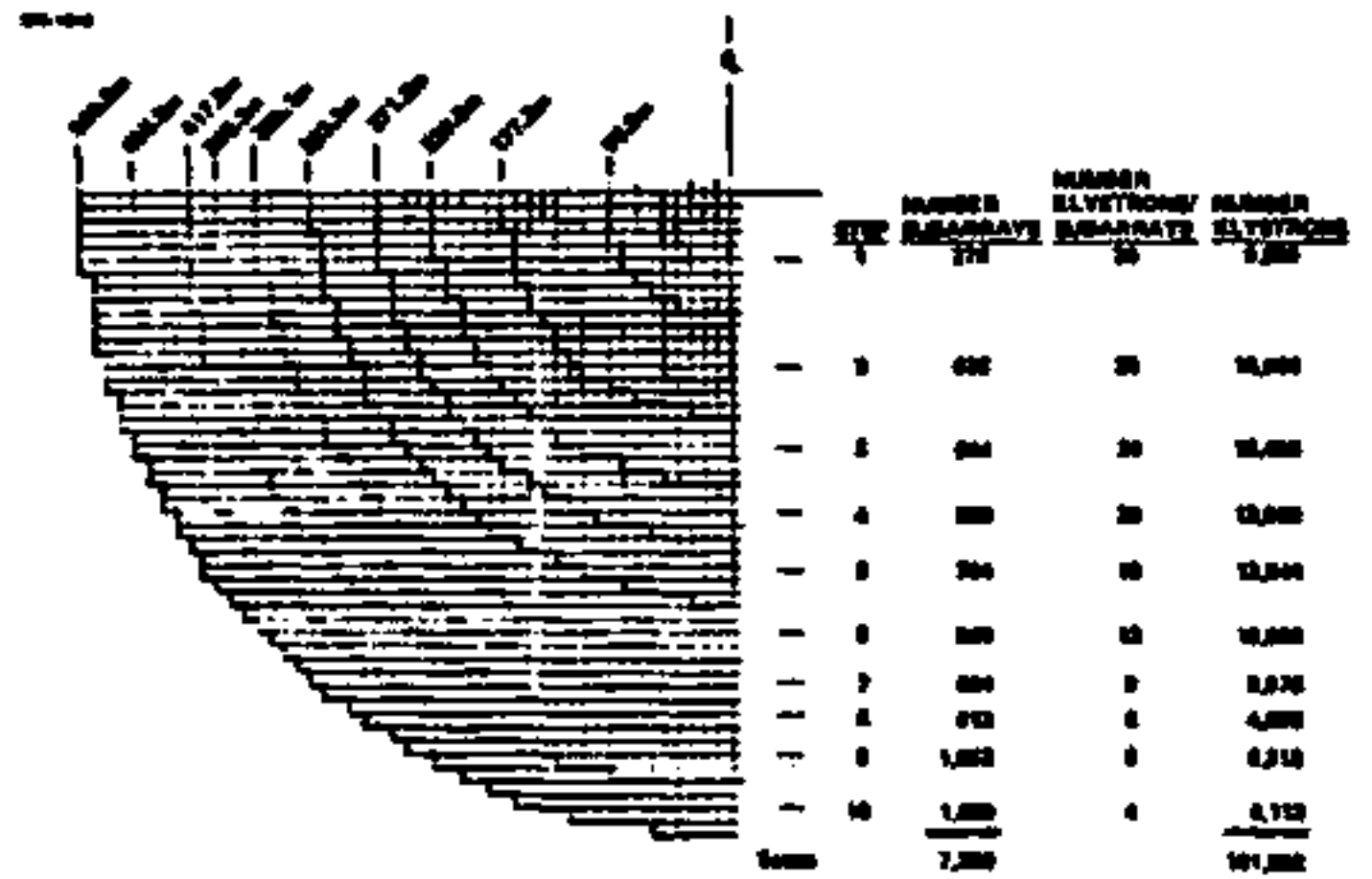

Figure 4- INDUSTRIAL INFRASTRUCTURE

Figure 5- MPTS REFERENCE POWER TAPER INTEGRATION

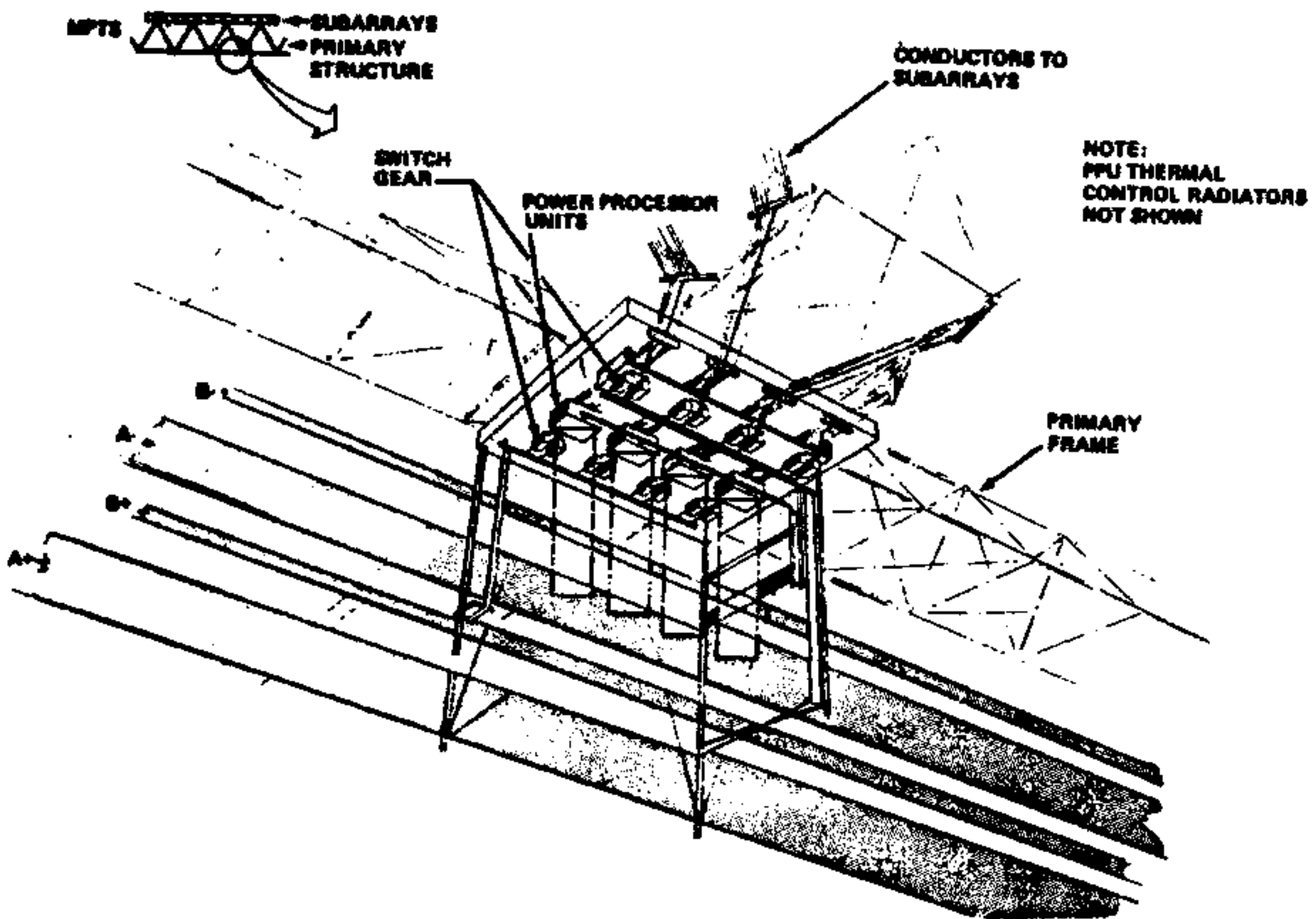

Figure 6- MPTS POWER PROCESSING SUBSTATION

PROTON DAMAGE ANNEALING KINETICS IN SILICON SOLAR CELLS
W. E. Horne, I. Arimura and A. C. Day
The Boeing Aerospace Company, Seattle, Washington 98124

Proton damage annealing has been postulated as a method for prolonging the life of solar power systems in space. This paper describes a study of such damage annealing. The objectives of the study were to 1) minimize variables and examine fundamental characteristics of proton damage annealing, 2) to make preliminary evaluation of the usefulness of annealing for prolonging space missions, 3) to make a preliminary determination of optimum annealing conditions, and 4) to provide a data base for planning more detailed research programs.

A preliminary analytical model has been developed to describe the annealing of proton damage as a function of time and temperature in silicon solar cells. The analytical work is supported by data from detailed isochronal and isothermal annealing experiments on 2-Ω-cm N/P silicon solar cells after irradiation to various fluences of 1.5 MeV protons.

The data indicate that several defect species are created in silicon during the irradiate-anneal process and that each species anneals with its own characteristic time-temperature kinetics. This observation is in general agreement with those of other workers for high energy electron and neutron damage annealing. The relative amount of each species of defect appears to be a function of either the silicon starting material, i.e., low or high dislocation density, or the impurity concentrations such as oxygen, phosphorous, and boron in the silicon. It is found that the annealing process for the cells studied can be described by a model which considers that at room temperature the defects consist mainly of vacancy clusters. In the temperature range 100 to 150°C these clusters begin to break up and release vacancies. Between 150 and 200°C, these released vacancies diffuse throughout the silicon and either pair with interstitial silicon atoms and disappear (anneal) or pair with other impurity atoms creating new defect species (reverse anneal). At still higher temperatures these newly created defects are disassociated and eventually annealed. This model is supported by the isochronal annealing data of figure 1. The model can be expressed analytically by the following equations:

$$N_v = N_v^0 e^{-\frac{T}{\tau_v}} \quad (1)$$

$$N_{1v} = \frac{N_1}{N_1 + N_1 + N_2} \left(\frac{\tau_{1v}}{\tau_v - \tau_{1v}} \right) N_v^0 \left[e^{-T/\tau_v} - e^{-T/\tau_{1v}} \right] \quad (2)$$

$$N_{2v} = \frac{N_2}{N_1 + N_1 + N_2} \left(\frac{\tau_{2v}}{\tau_v - \tau_{2v}} \right) N_v^0 \left[e^{-T/\tau_v} - e^{-T/\tau_{2v}} \right] \quad (3)$$

where N_V^0 is the number of vacancy clusters after irradiation, N_V is the number of vacancy clusters as a function of time, N_{1V} is the number of impurity number 1-vacancy complexes as a function of time, N_{2V} is the number of impurity number 2-vacancy complexes as a function of time, τ_V , τ_{1V} , τ_{2V} are the annealing time constants for vacancy clusters, impurity number 1-vacancy, and impurity number 2-vacancy respectively, and N_i , N_1 , N_2 are the number of interstitials, impurity number 1, and impurity number 2 atoms respectively. Then the degradation in short circuit current can be expressed by:

$$\frac{1}{I_{sc}^2} - \frac{1}{I_{sc0}^2} \approx K_V N_V + K_{1V} N_{1V} + K_{2V} N_{2V} \quad (4)$$

$$F = \frac{\frac{1}{I_{sc}^2} - \frac{1}{I_{sc0}^2}}{\frac{1}{I_{sc\phi}^2} - \frac{1}{I_{sc0}^2}} \approx \frac{K_V N_V + K_{1V} N_{1V} + K_{2V} N_{2V}}{K_V N_V^0} \quad (5)$$

$$F = e^{-\frac{t}{\tau_V}} \left\{ 1 + \frac{1}{K_V(N_1+N_2)} \left[\frac{N_1 K_{1V} \tau_{1V}}{\tau_V - \tau_{1V}} \left(1 - e^{-t \left(\frac{1}{\tau_{1V}} - \frac{1}{\tau_V} \right)} \right) + \frac{N_2 K_{2V} \tau_{2V}}{\tau_V - \tau_{2V}} \left(1 - e^{-t \left(\frac{1}{\tau_{2V}} - \frac{1}{\tau_V} \right)} \right) \right] \right\} \quad (6)$$

where F is the fraction of defects remaining, I_{sc} is the short circuit current as a function of time, I_{sc0} is the short circuit current before irradiation, and $I_{sc\phi}$ is the short circuit current immediately after irradiation. That the equation (6) can qualitatively describe the annealing process is illustrated by the isothermal annealing data of figures 2, 3, 4, and 5 compared to a calculated curve using equation (6). It is hypothesized that impurity number 1 is oxygen and impurity number 2 is the dopant impurity boron. This hypothesis is supported by comparison of annealing temperatures for each stage to that of neutron annealing data where the defects have been more positively identified.

Figures 6 and 7 show the degree to which the power output of the proton damaged cells can be restored. From these data it appears advantageous to anneal at as high a temperature as possible. It was further observed that the cells annealed after 3×10^{11} p/cm² annealed more rapidly and more completely than those annealed after 3×10^{12} p/cm².

It is further interesting to note that, although the cells had relatively uniform electrical characteristics and degraded in a uniform manner as illustrated in figure 8, the annealing response showed a wide degree of scatter both in recovery times and in degree of recovery. This suggests that the annealing process is governed by parameters which do not strongly affect either initial cell performance or cell radiation resistance. If this is true and the factors yielding faster and more complete recovery can be identified then cells optimized for annealing should be possible.

Conclusions that can be drawn are that 1) the annealing can be effective in restoring the performance of proton damaged cells and 2) factors such as silicon starting material, dopant materials, proton energy spectrum, damage level at which anneals are performed, temperature/time profiles, and solar cell junction designs should be considered in order to optimize annealing conditions.

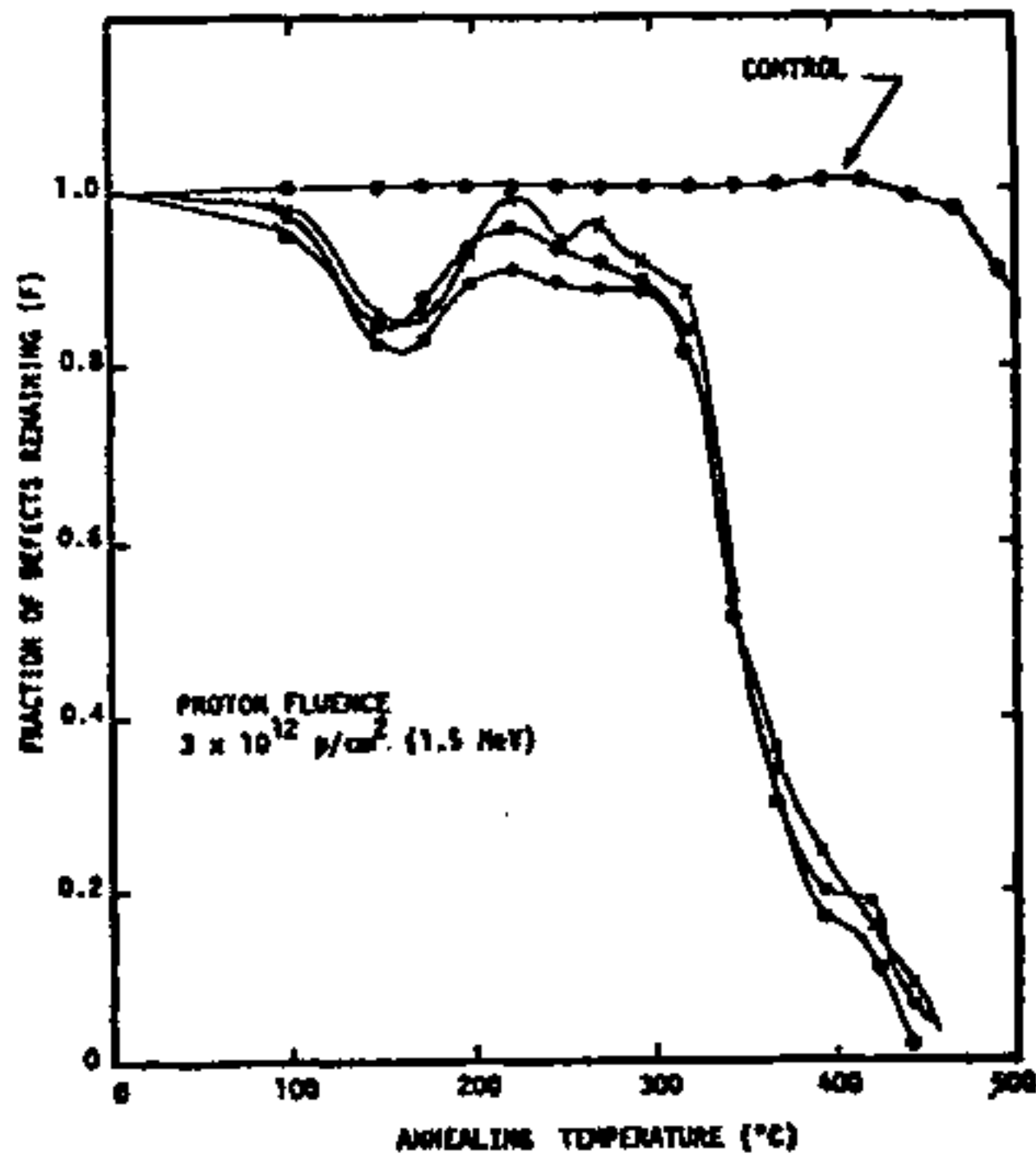

Figure 1. Isochronal Annealing of Proton Damage

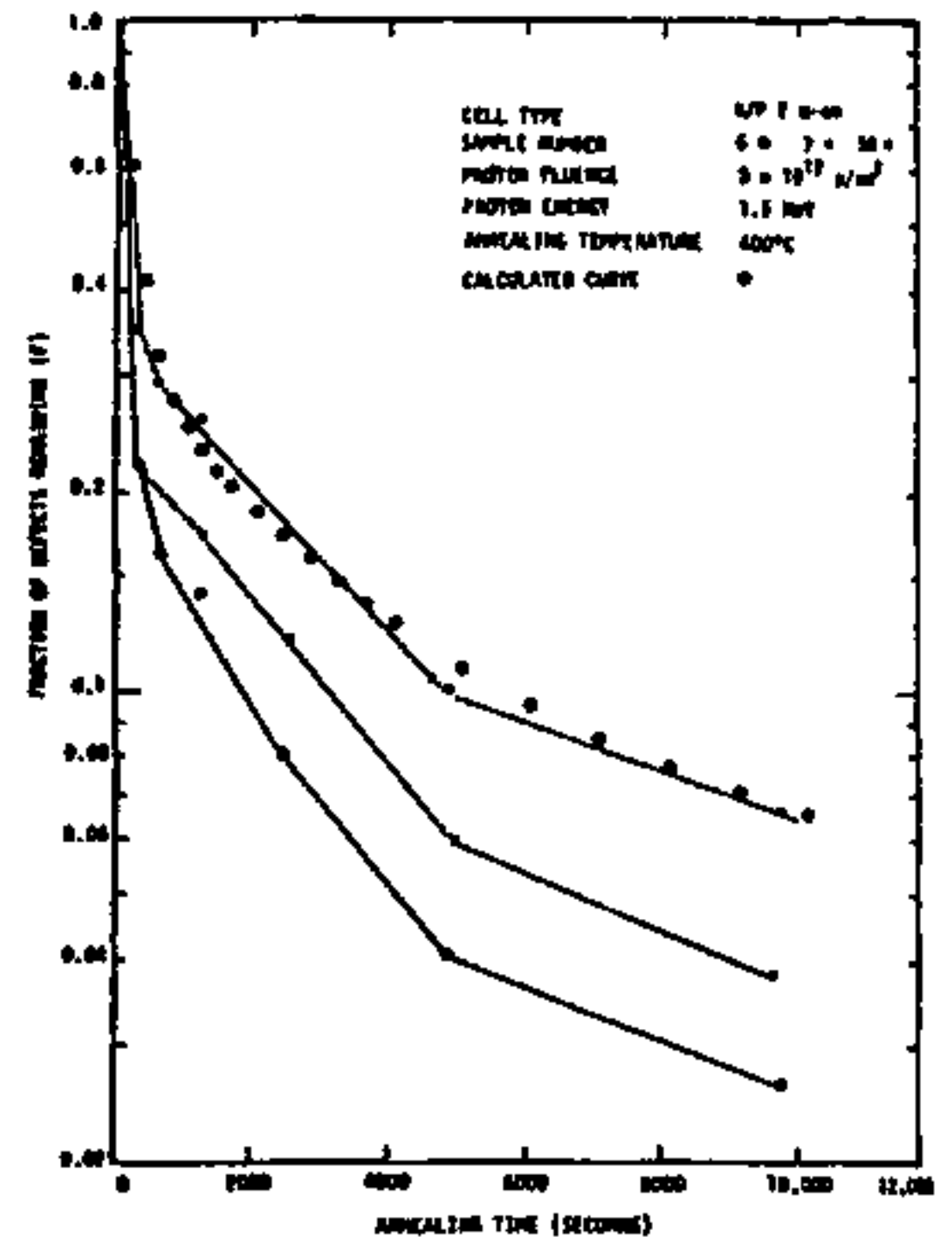

Figure 2. Isothermal Annealing of 3×10^{12} p/cm² Proton Damage at 400°C

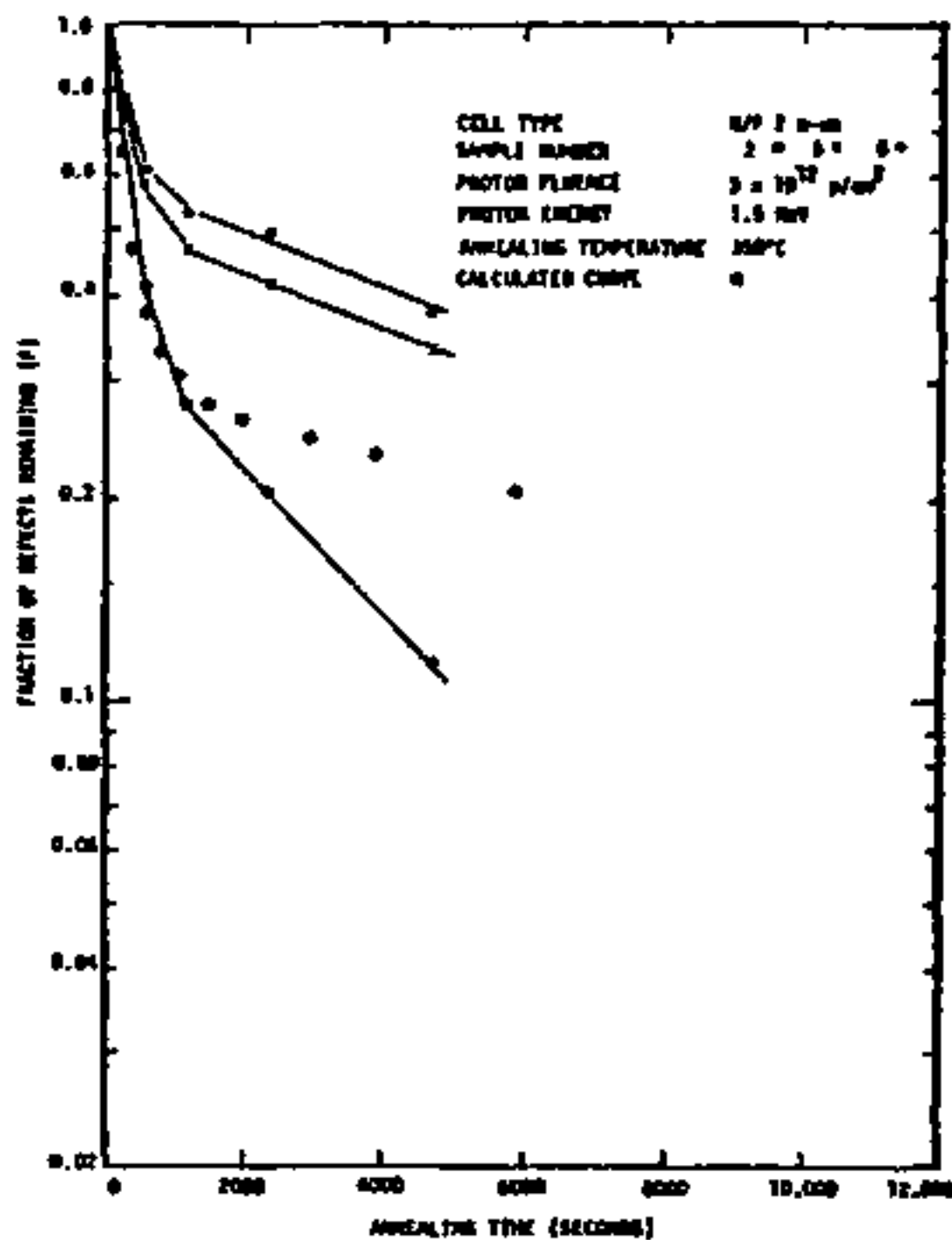

Figure 3. Isothermal Annealing of 3×10^{12} p/cm² Proton Damage at 350°C

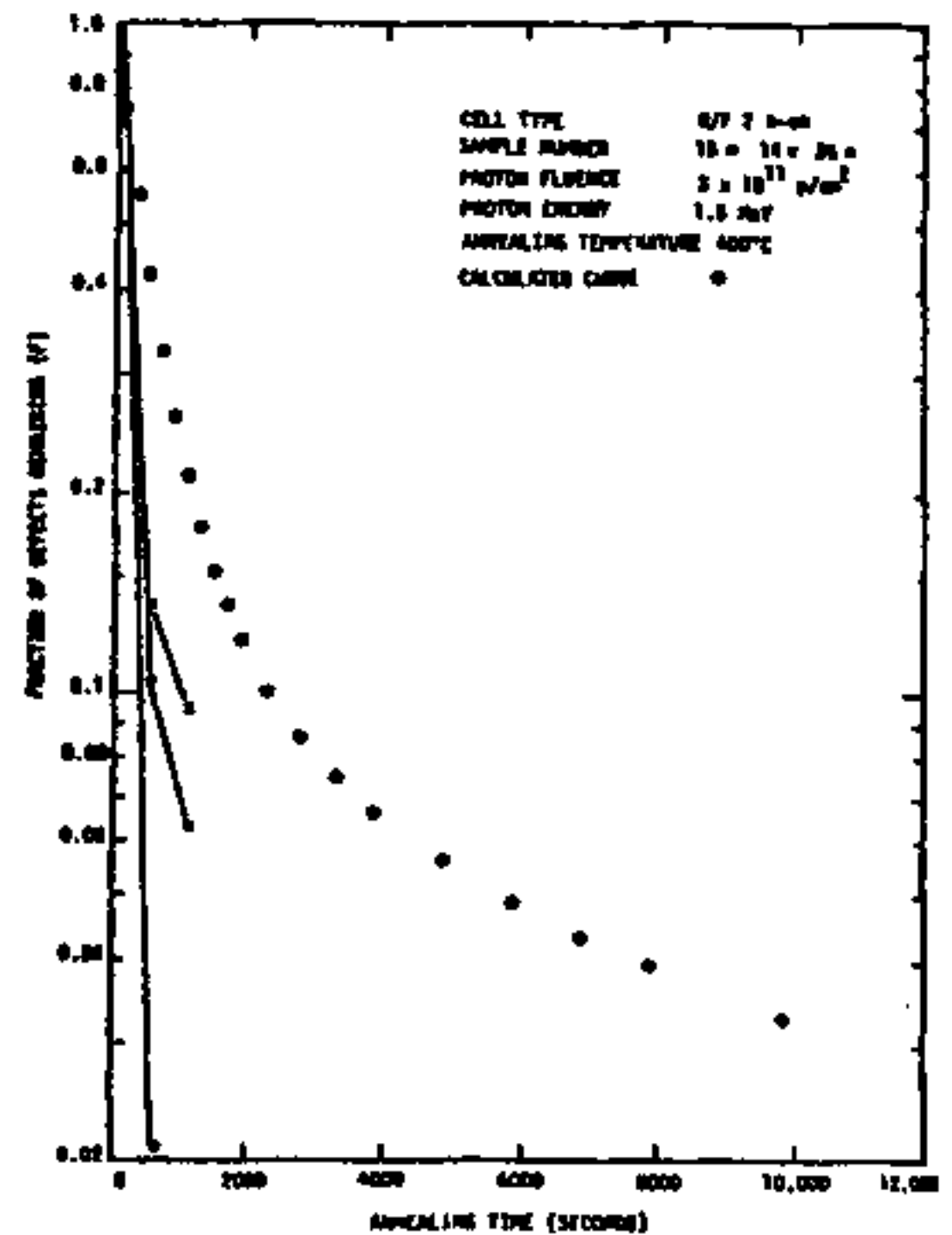

Figure 4. Isothermal Annealing of 3×10^{11} p/cm² Proton Damage at 400°C

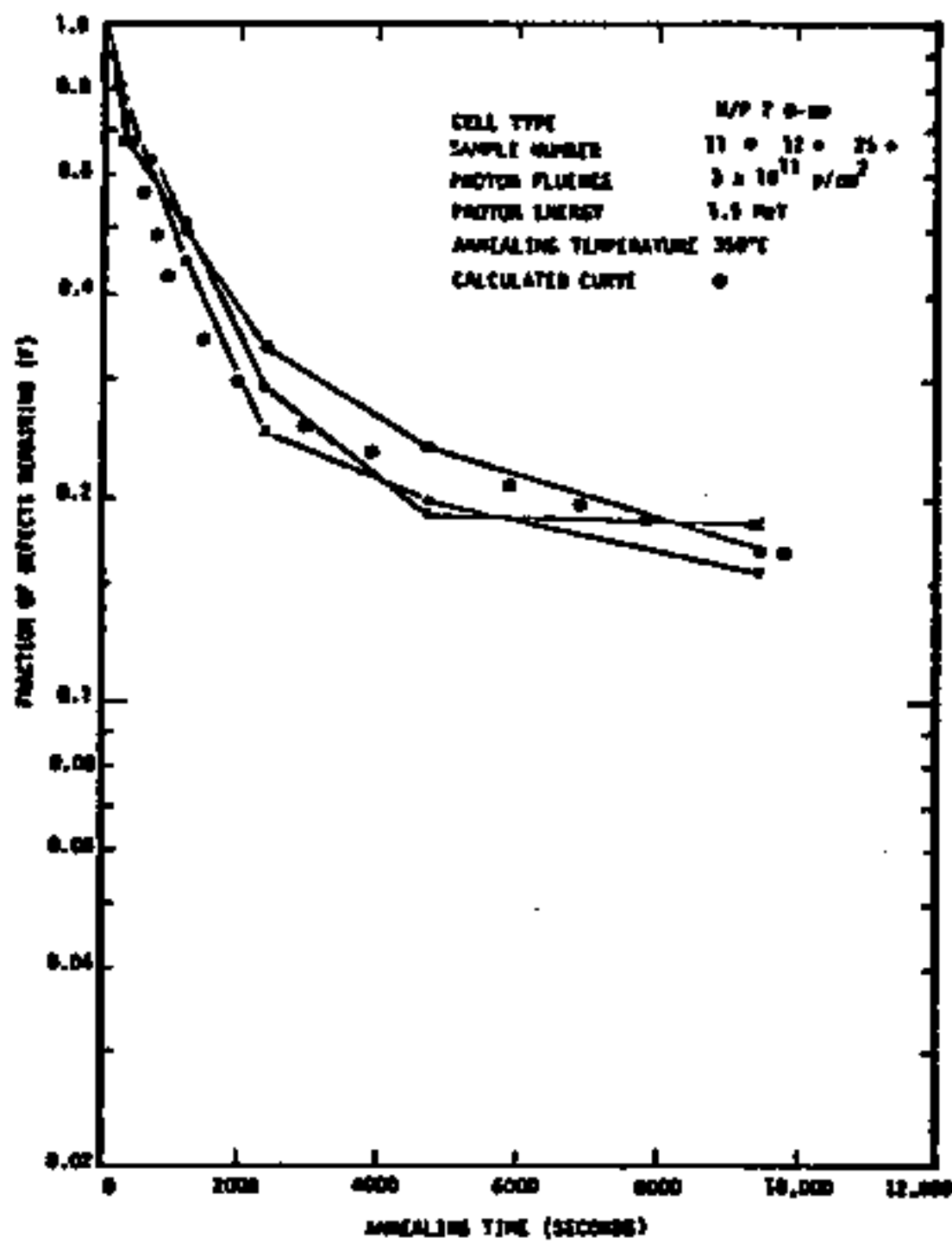

Figure 5. Isothermal Annealing of 3×10^{11} p/cm² Proton Damage at 350°C

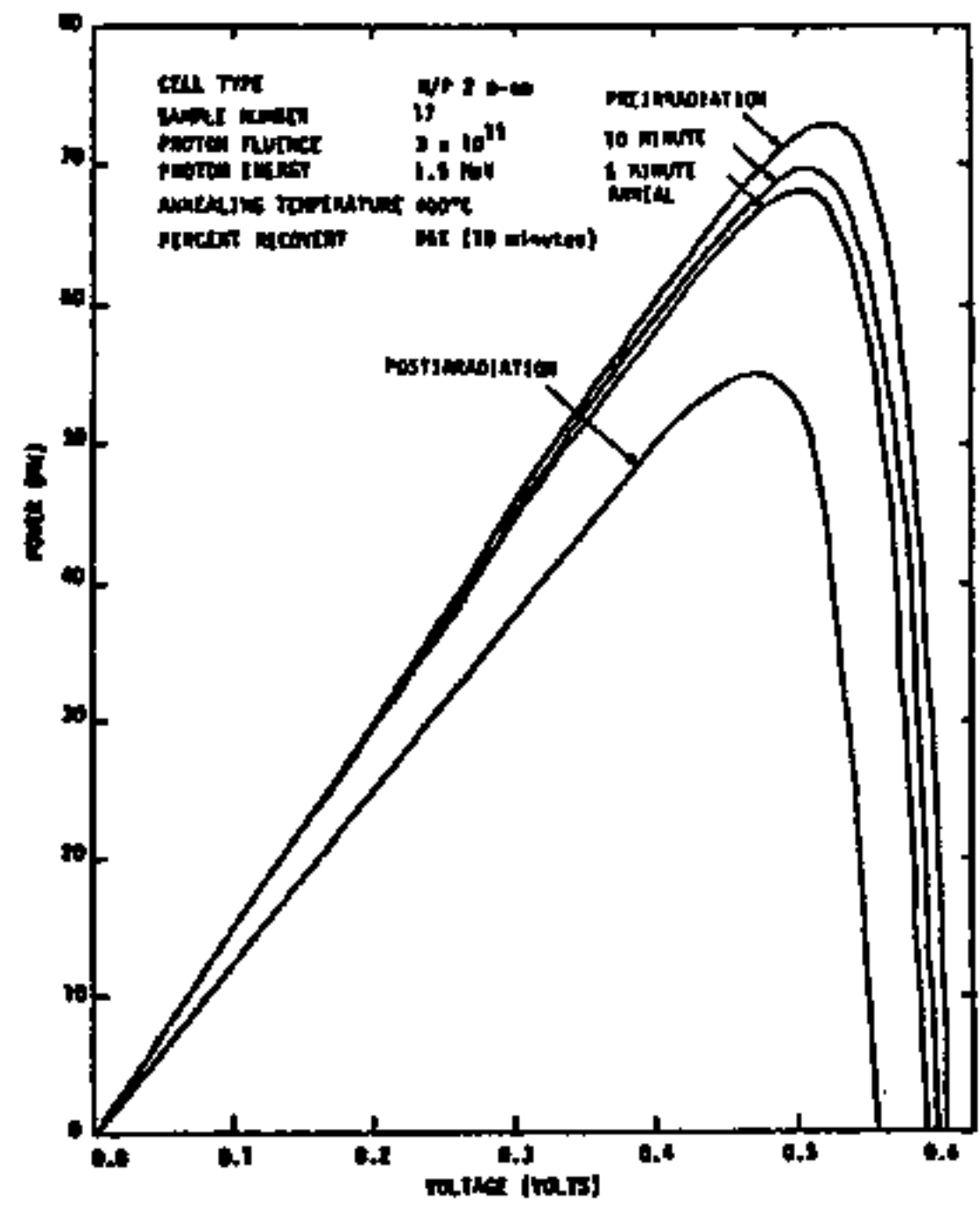

Figure 6. Recovery of Solar Cell Power After 3×10^{11} p/cm² at 400°C

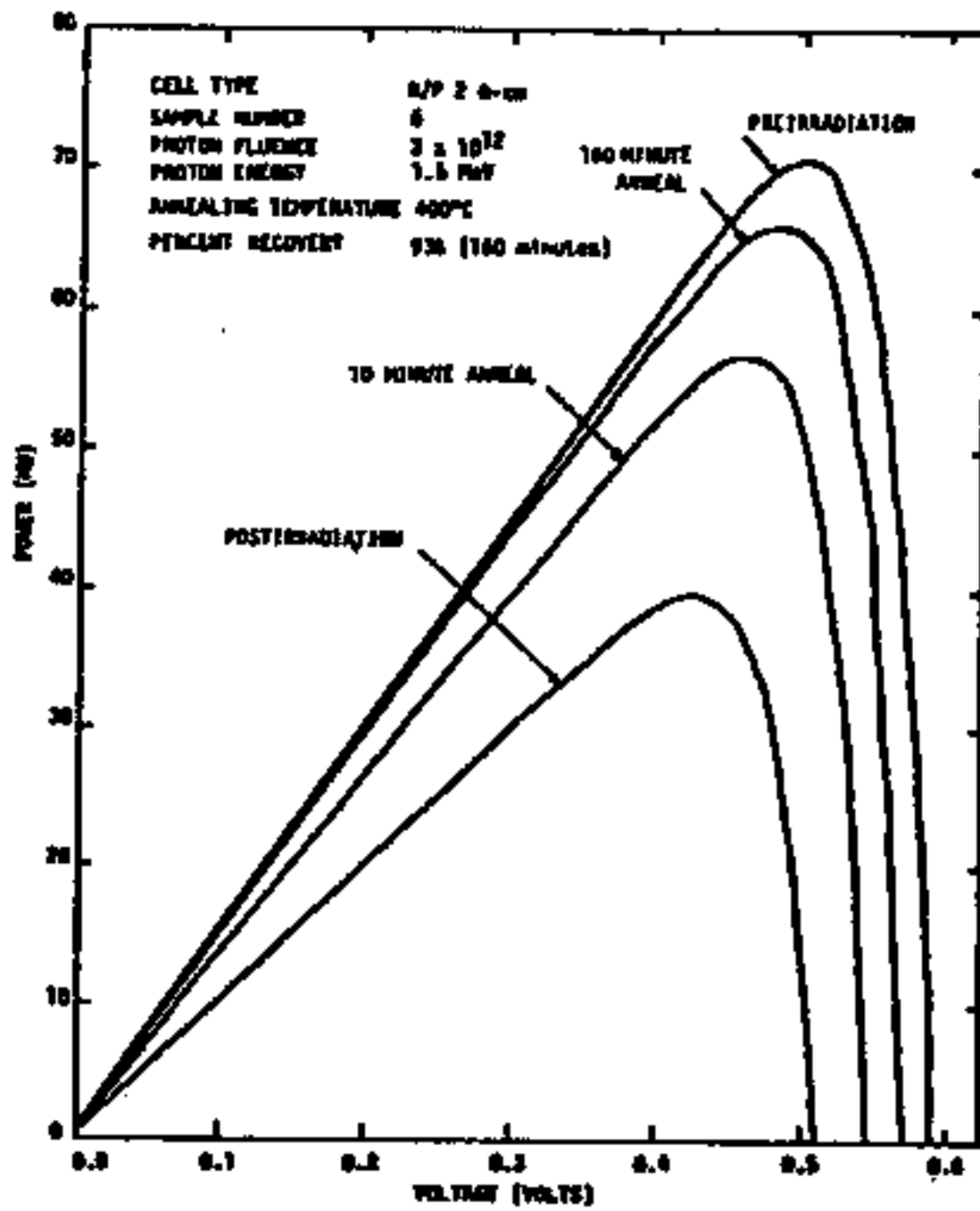

Figure 7. Recovery of Solar Cell Power After 3×10^{12} p/cm² at 400°C

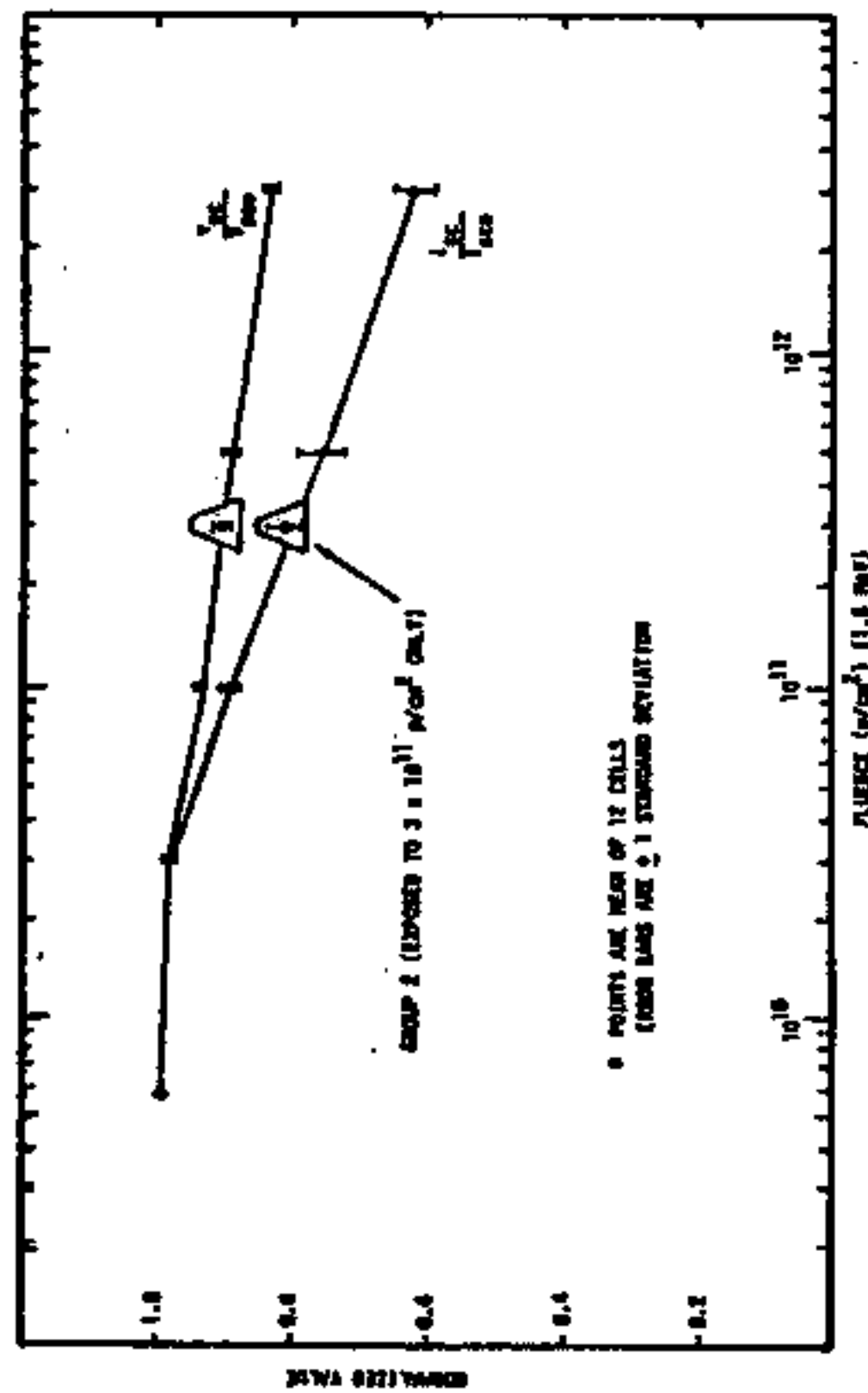

Figure 8. Normalized Degradation of 2 Groups of 12 Each N/P 2-Ω-cm Cells Exposed to 1.5 MeV Protons

A SURVEY OF THE MARKET, SUPPLY AND AVAILABILITY OF GALLIUM
Dr. Fred D. Rosi
University of Virginia - Charlottesville, Virginia

The major market for gallium is the electronics industry (see Table I), which requires the metal in its highest form of purity (99.9999%). The price for this grade of gallium is now \$525/kg.

The free-enterprise consumption of gallium is estimated to be 14,000 kg., and is not expected to increase significantly over the next few years despite the emergence of new electronic applications requiring gallium compounds, such as magnetic bubble memories and optical fiber telecommunications. Since the free world production capacity of gallium is about 25,000 kg., an over-supply situation now exists. This could be dramatically reversed with the widespread use of gallium arsenide photovoltaic cells in future terrestrial and space power systems.

Bauxite ores containing 0.003-0.009% gallium account for over 90% of the world supply of gallium. Extraction efficiencies of 30-50% are realized with commercial processes (schematically depicted in Figure 1), and efficiencies as high as 80% are considered possible by modifications of these processes. The commercial extraction methods can provide gallium with a purity of 99.9%. Conversion of this grade gallium to the high purity (6 nines) form requires additional processing, which raises the gallium price by at least \$100/kg.

In the free-enterprise world, the major suppliers of primary gallium are Alcoa in the United States and Alusuisse in Switzerland. These companies account for over 90% of the free world supply of gallium to meet current market needs.

Data on the primary aluminum production from bauxite throughout the free-enterprise world suggest that approximately 1,370 metric tons of gallium were potentially available in 1978 by present extraction technologies and assuming an average content of 0.006% Ga in bauxite. Since the world production capacity of gallium is estimated to be 25 metric tons, less than 2% of the bauxite used in obtaining alumina for primary aluminum production was processed for gallium extraction.

The 5 GW satellite power system using gallium arsenide solar cells, now under study by NASA, would require 390 metric tons of gallium. This represents a 1,600% increase over present free world production capacity (25 metric tons), and 28% of the potentially available gallium (1,370 metric tons) from bauxitic ores currently processed to produce primary aluminum. A network of such satellites would necessitate an essentially new gallium recovery industry, which would have to be coupled closely with the aluminum industry for economic reasons.

Approximately 65% of the world bauxite comes from Australia, Guinea, Jamaica and Surinam (see Table II). Three of these countries also have large commercially proven reserves. Australia is now the major producer of bauxite with 26.5 million long tons in 1978. Its abundant commercial reserves serve to insure the free-enterprise world supply of bauxite for years to come. Guinea is the second major producer with 17 million long tons followed by Jamaica, which was the major bauxite producer until 1972. With its new discoveries of bauxite ores, Brazil may become a major producer within the next five years. The United States, which is the major producer of primary aluminum, depends heavily on

foreign sources of bauxite principally from Jamaica (55% of imports), Surinam, Guyana, the Dominican Republic, Haiti and Guinea.

The world-wide commercial reserves of bauxite total 26,880 million long tons, which represent a 320 year supply at the 1978 production level of 84 million tons. Estimated cumulative demand for bauxite by the year 2000 is still only 13% of current commercial reserves.

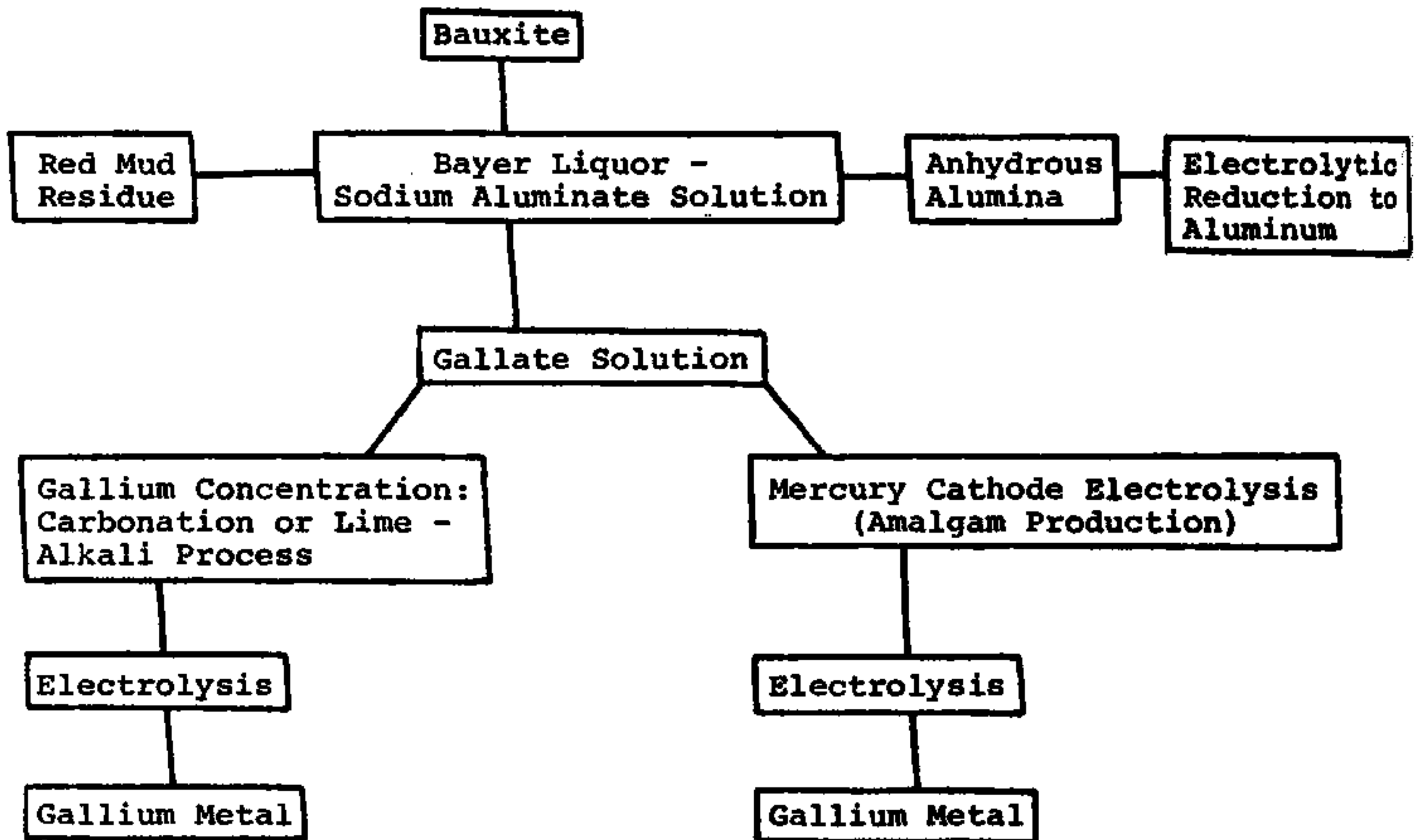

Fig. 1 - Schematic process steps in commercial methods for extracting gallium from bauxite.

Table I. U. S. Consumption of Gallium
by End Use in Kilograms.*

End Use	1975	1976	1977
Specialty Alloys	7	4	4
Electronic Devices	7,338	8,210	7,965
Research and Development	91	609	763
Unspecified Uses	57	57	57
Total	7,493	8,880	8,789

*Bureau of Mines Minerals Yearbook, 1976 and 1977

TABLE II. COMMERCIAL BAUXITE PRODUCTION AND RESERVES IN 1978.
(MILLIONS OF LONG TONS¹)

	<u>1978 Production</u>	<u>% of Total</u>	<u>1978 Reserves</u>	<u>% of Total</u>
United States	1.7	2.0	40	0.2
Australia	26.5	31.5	6,400	23.8
Brazil	1.0	1.2	2,500	9.3
Greece	3.0	3.6	750	2.8
Guinea	12.0	14.3	8,200	30.5
Guyana	3.0	3.6	1,000	3.7
India	1.5	1.8	1,600	6.0
Jamaica	11.4	13.6	2,000	7.4
Surinam	5.0	6.0	490	1.8
Other Market Economies ²	6.7	7.9	2,800	10.4
Hungary	3.0	3.6	300	1.1
Soviet Union	4.7	5.6	200	0.8
Other Central Economies ³	<u>4.5</u>	<u>5.3</u>	<u>600</u>	<u>2.2</u>
Total	84.0	100.0	26,880	100.0

1. Long Ton equals 2,240 lbs.

2. (France, Italy, Yugoslavia, Dominican Republic, Haiti and others)

3. Sino-Soviet Bloc Countries, Mostly China

Source: U. S. Department of Interior
Bureau of Mines
Commodity Data Summaries, 1978

EVALUATION OF SOLAR CELL MATERIALS FOR A SOLAR POWER SATELLITE¹

Dr. Peter E. Glaser - Dr. David W. Almgren - Ms. Katinka I. Csigi
Arthur D. Little, Inc. - Cambridge, Massachusetts

As originally conceived, a solar power satellite (SPS) can utilize current approaches to solar energy conversion, e.g., photovoltaic, thermal electric, and others, which may be developed in the future. Among these conversion processes, photovoltaic conversion represents a useful starting point because solar cells already are in wide use in satellites. An added incentive is the substantial progress being made in the development of low-cost reliable photovoltaic systems for terrestrial applications, the increasing confidence in the capabilities to achieve the required production volumes to sustain expanded markets. Figure 1 projects the cost reduction of silicon solar cells and the necessary transition to thin-film solar cells which will have to be developed to meet projected terrestrial photovoltaic system production and cost goals.

Several photovoltaic energy conversion systems applicable to the SPS concept have been evaluated. Two alternative photovoltaic systems—one employing single-crystal silicon, and the other, gallium arsenide—have been selected for the SPS reference system. The silicon photovoltaic system utilized 50 μm thick, single-crystal, silicon solar cells sandwiched between layers of 75 μm and 50 μm thick borosilicate glass, while the alternative design utilizes 5 μm thick, single-crystal heteroface gallium arsenide solar cells formed by a chemical vapor-deposition process on a 20 μm layer of sapphire as the substrate/cover glass for the solar cell. The array is then encapsulated with 13 μm of Teflon bonding the solar cell to a 25 μm Kapton cover. The gallium arsenide solar cells are integrated with thin-film Kapton solar reflectors with a concentration ratio of 2 to reduce the required solar cell area. The mass of the photovoltaic systems represents 40% of the mass of the SPS reference system.

The beginning of life (BOL) and end of life (EOL) conversion efficiencies of the SPS solar cells has a significant impact on the total size of an SPS and the total mass that has to be carried to geosynchronous orbit.

The SPS system studies have been primarily concerned with such photovoltaic factors as:

- Beginning of life solar cell efficiency;

- Rate of degradation of output on
 - orbit
 - solar cell/array/system performance:
- Photovoltaic efficiency recovery techniques;
- Cell/array cost;
- Mass; and
- Availability of photovoltaic materials.

In addition to these parameters, consideration has to be given to the cell/array manufacturing processes to meet SPS production requirements and cost goals.

Silicon is presently the only photovoltaic material that is being considered for mass production as part of the U. S. Department of Energy (DOE) Photovoltaic Program.² Single-crystal silicon solar cells could meet the projected needs of the ground-based exploratory development and space technology verification during the period 1980 to 1985, and is the most likely photovoltaic material for use in SPS pilot and prototype systems. Gallium arsenide is a promising photovoltaic material, however, gallium arsenide solar cells in suitable form, sufficient quantity, having reproducible characteristics and an acceptable cost are unlikely to be available before 1985 unless there is a near-term significant R&D program commitment. Furthermore, other advanced photovoltaic materials, e.g., amorphous silicon, are being investigated as part of the DOE Photovoltaic Program which may deserve consideration as candidates for SPS solar cell arrays if they could be mass produced at low cost.

The industrial capability needed to manufacture the SPS solar cells and arrays will require the development of large-volume production technology which could serve both the SPS and terrestrial PV system requirements. Figure 2 presents a solar cell/array production scenario based on the deployment of one 10 GW on two 5 GW SPS's per year including inventory accumulation. This implies that the selection of solar cell materials and array designs will be completed by 1985, and that a long-term on-orbit solar cell array test program will provide data on the performance of candidate solar cell arrays in the space environment prior to commitment to a pilot-plant program.

The scale of commitment of capital material and labor resources to construct large-scale manufacturing facilities will require that the risks and uncertainties in achieving required solar cell/array performance and cost goals have been evaluated and that they are acceptably low. Funding commitments for gallium arsenide, or other promising photovoltaic materials, would have to approach the present level of funding for silicon solar cells in the next several years so that they could be considered for an operational SPS in the 2000 time frame.

¹Arthur D. Little, Inc., "Evaluation of Solar Cells and Arrays for Potential Solar Power Satellite Applications." Final Report to NASA Lyndon B. Johnson Space Center, March 1978.

²U.S. Department of Energy, National Photovoltaic Program, Multi-Year Program Plan, June 6, 1979. DOE/ET-0105-D.

PHOTOVOLTAIC CELL/ARRAY PRICE GOALS AND HISTORY

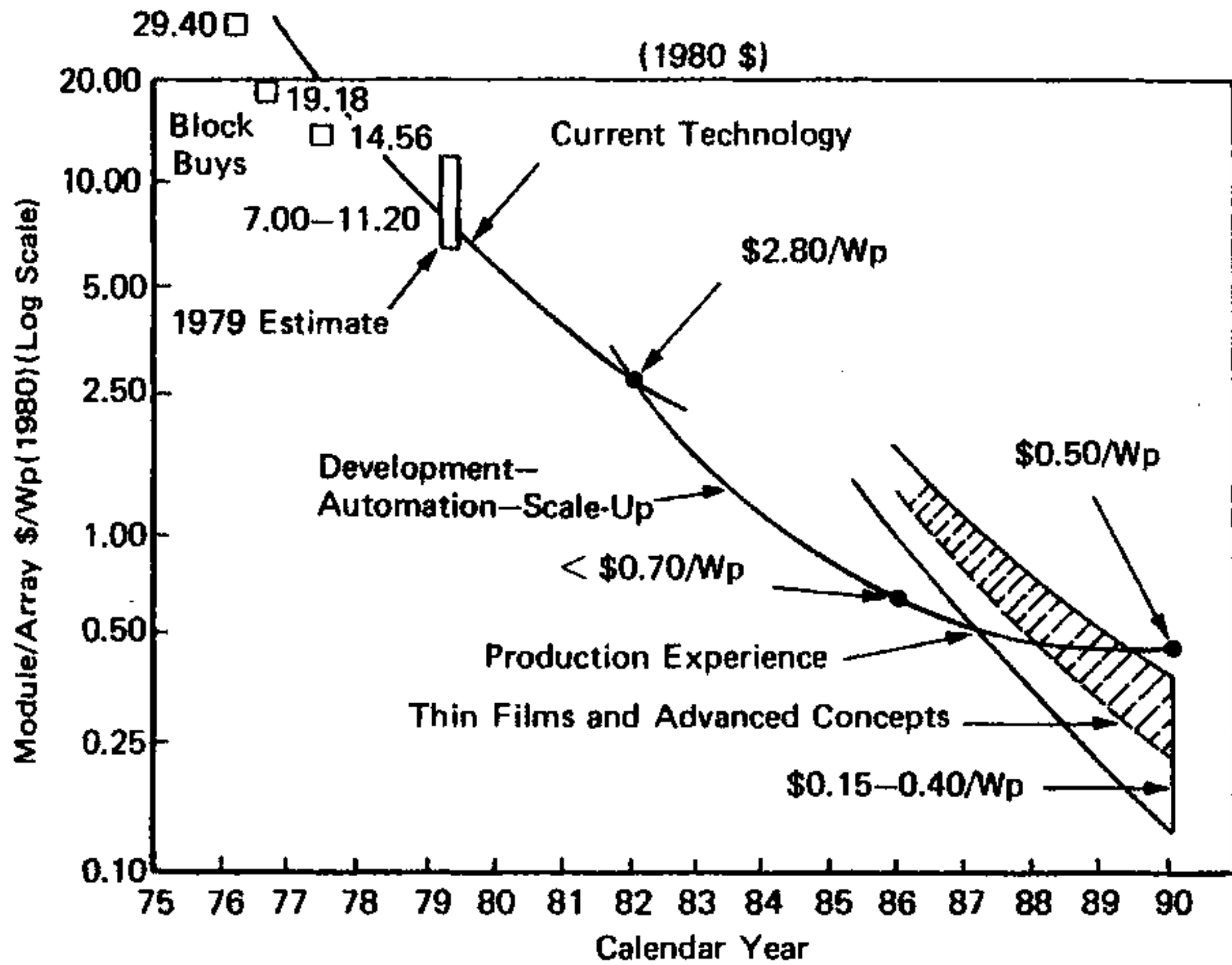

Source: Department of Energy, Reference 2.

Figure 1.

SOLAR CELL/ARRAY PRODUCTION SCENARIO FOR YEAR 2000 SPS DEPLOYMENT

(Inventory Accumulation)

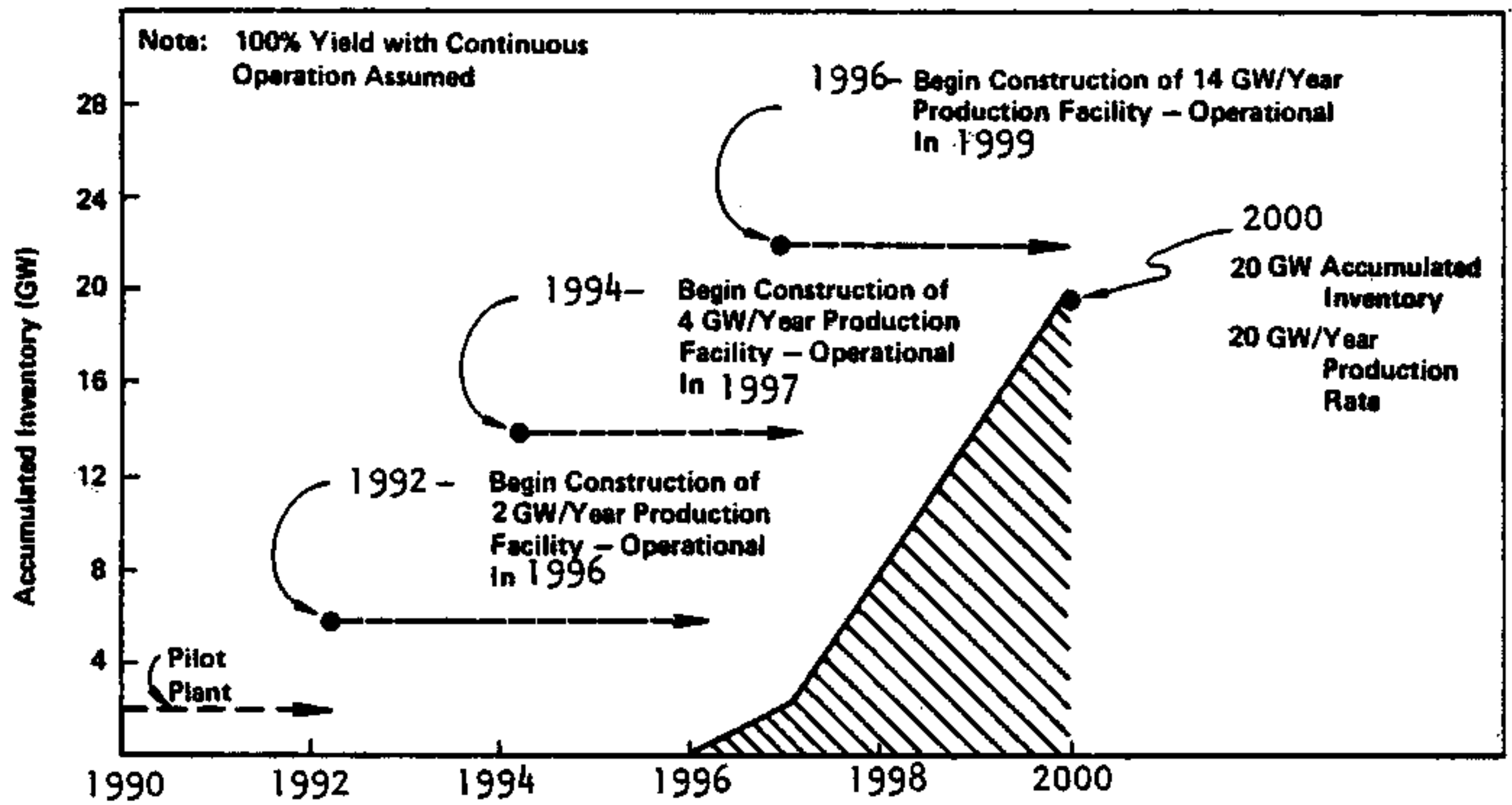

Figure 2.

SOLAR DRIVEN LASERS FOR POWER SATELLITE APPLICATIONS
R. Taussig, P. Cassady and E. Klosterman
MSNW, Inc., 2755 Northrup Way, Bellevue, Washington 98004

Introduction. Multi-megawatt lasers appear to be technologically feasible for space power transmission in the 1990s time frame. Solar driven lasers based on conventional gas dynamic and electric discharge laser concepts (GDLs and EDLs) have been investigated to determine the feasibility of using existing laser technology for this application. With conventional solar photocells as the power source the GDL and EDL lasers do not appear to be as efficient as microwaves in transmitting power back to earth. However, for relatively new and untested laser concepts such as the solar optically pumped laser (OPL) and free electron laser (FEL) much higher laser efficiencies may be achievable, leading to a laser SPS system competitive with the microwave SPS. Because of their compact transmitters and receivers, lasers may have an advantage in better economies of scale for smaller SPS sizes than the microwave SPS. Further, laser light wavelengths longer than 2.5 microns may be considerably safer and have less impact on the earth's environment (e.g., communications) than microwaves. For these reasons one should consider the laser as a serious power transmission option.

Results from a brief survey of solar powered, space-based lasers are given below to gain some perspective on the types of lasers reasonable for power transmission. A preliminary selection of candidate lasers for SPS application was made on the basis of scalability to high powers (1 MW and greater), relative weights, efficiency (better than 1%), and safety (wavelengths greater than 2.5 μ). The preliminary list includes CO and CO₂ EDLs, direct optically pumped lasers (e.g., CF₃I, etc.), indirect optically pumped lasers (e.g., CO/CO₂ mixing laser), and free electron lasers (FELs).

Electric Discharge Lasers. Several previous studies have focused on solar powered, closed cycle EDLs for power transmission. The EDL requires electric power both to drive the high voltage discharge which pumps the laser medium to an excited state before it lases, and to circulate the lasant through a cooling loop which extracts the waste heat and returns it to its original state. Either photocells or perhaps a more efficient solar thermal power cycle can be used to produce the electricity. Table 1 summarizes the characteristics of the EDL and other 1 MW cw solar powered lasers, where electricity in each case is assumed to be produced by a 25% efficient solar thermal Brayton cycle power system. Monson has shown how to optimize the closed cycle flow conditions for minimum flow loop compressor power per unit laser power output. His results are employed to keep the total laser system weight small.

Direct Optically Pumped Lasers. A preliminary consideration of the direct optically pumped lasers in a previous study suggested that the only class of direct optically pumped lasers with reasonable efficiency capable of high power operation are those utilizing CF₃I, C₃F₇I, C₆F₉I, and (CF₃)₂AsI. These molecules photodissociate in the near UV of sunlight. With proper filtering, only the solar wavelengths appropriate for pumping the molecules need to be focused on the lasant. Concentration ratios on the order of 100 appear adequate to pump the heavier versions of these iodine molecules leaving an excited I* which lases at 1.315 μ . Unfortunately, this wavelength is smaller than the safety limit of 2.5 μ for retinal damage. The dissociated fragments of these molecules also polymerize so that in a closed cycle lasant for space, a substantial amount of

Table 1
1 MW cw Output Solar-Powered Laser Candidates

<u>Type</u>	<u>Lasant</u>	<u>λ Laser</u>	<u>η_T Transmission Efficiency</u>	<u>η_L Laser Solar Efficiency</u>	<u>η_{total}^{**}</u>	<u>Mass</u>
Electric Discharge (EDL)	CO (Supersonic)	$\sim 5\mu$	57% (94%)*	5.7% ⁺	2%	17×10^3 kg
	CO ₂ (Subsonic)	9.26 μ	80% (90%)	3.8%	1%	20×10^3 kg
Direct Optically Pumped (OPL)	CF ₃ * (Subsonic) Dissociation	1.315 μ	95% (est)	0.5%	.2%	60×10^3 kg
Blackbody Optically Pumped (OPL)	CO/CO ₂ (Subsonic) Mixing	9.114 μ	83% (95%)	15.4%	6%	30×10^3 kg
CATALAC (FEL)	Relativistic Electron Beam	Tunable $\lambda > 2.5\mu$	95% (est)	0.4 ~ 1.2%	.5%	80×10^3 kg
Storage Ring (FEL)			95% (est)	6 ~ 20%	8%	14×10^3 kg

* to ground (to 2 km elevation)

+ 25% conversion from solar to electricity assumed

** $\eta_{total} = \eta_L \eta_T \eta_G$ where $\eta_G = 0.4$ and $\eta_T(2 \text{ km})$

energy must be invested to break apart the polymerized fragments and reconstitute the original molecule. The overall efficiency of this type of laser, not including the energy needed for reconstitution of the lasant, is approximately 0.5% (laser power \div solar power).

Indirect Optically Pumped Lasers. Three indirect optically pumped lasers have been examined:

- Static CO₂ laser
- Flowing CO laser (subsonic)
- Mixing CO/CO₂ laser (subsonic)

Of these three only the last one combines the features of scalability, high efficiency, and laser wavelength suitable for atmospheric transmission. At this stage CO lasers appear to transmit successfully only on isolated lines and, since the CO laser is relatively inefficient when operated in a single line mode, it has not been considered further. The indirect optically pumped laser (IOPL) uses a solar heated blackbody cavity to pump the lasant. The advantages of the cavity are reduced radiative losses, a downshift in the peak of the pump radiation toward the infra-red absorption lines of CO and CO₂, an increase in the irradiation of the lasant to a full 4 π steradians, and refilling the spectral lines absorbed by the lasant through radiative re-emission of a full blackbody spectra by the cavity walls. As in the direct optically pumped case, the IOPL needs electricity or mechanical power only for circulating coolants and moving the lasant through the laser optical cavity. From Table I it appears initially that this class of laser will be quite lightweight. The mixing gas version is shown in Figure 1. Initial gain experiments have been performed indicating the viability of the blackbody radiation pump method. Further research is needed to demonstrate the complete laser concept.

Free Electron Lasers. We have also investigated three possible versions of the free electron laser: the CATALAC FEL, the Double FEL, and the Storage Ring FEL. The CATALEC FEL, illustrated schematically in Figure 2, is based on a concept developed at LASL to help recapture some of the energy left over in the electrons as they exit from the laser cavity. These electrons are recirculated through the rf-linac 180° out of phase with the next bunches of electrons to be accelerated. The electrons are decelerated and return most of their remaining energy to the accelerating field. The linac therefore behaves as a catalyst for transferring the energy of decelerating electrons to those being accelerated. The spent electrons are collected at the other end of the linac with approximately 8 MeV energies and the accelerated electrons emerge with energies on the order of 50 MeV.

No high power FELS have been built in the wavelength range suitable for atmospheric propagation so that this laser technology must be regarded as extremely tentative. Elementary gain and oscillator experiments have been performed by Madey and his co-workers at Stanford which indicate that the principle will work. Several larger FEL experiments for 1μ lasers are now in the planning stage and are due to come on line in late 1980 or 1981. Nevertheless, a substantial amount of theoretical analysis has been performed which permits us to carry out elementary scaling calculations; the results of these are included in Table I for the CATALAC FEL which operates essentially as a once-through device with good energy recover, and for the storage ring FEL. The double FEL is, at present, too sensitive to assumptions made regarding low losses of the standing EM wave used as the virtual wiggler field.

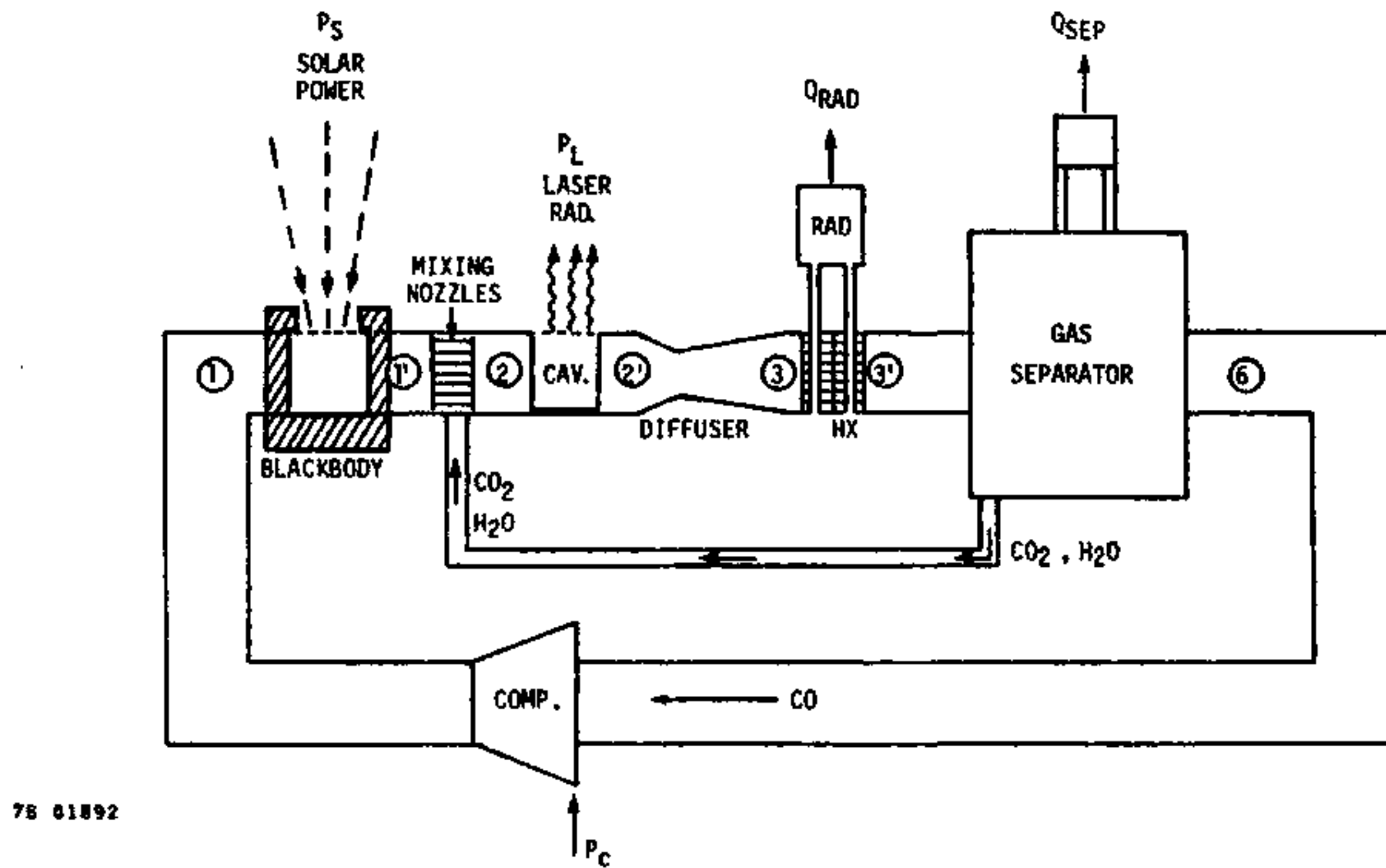

Figure 1. Indirect Optically Pumped CO/CO₂ Mixing Laser

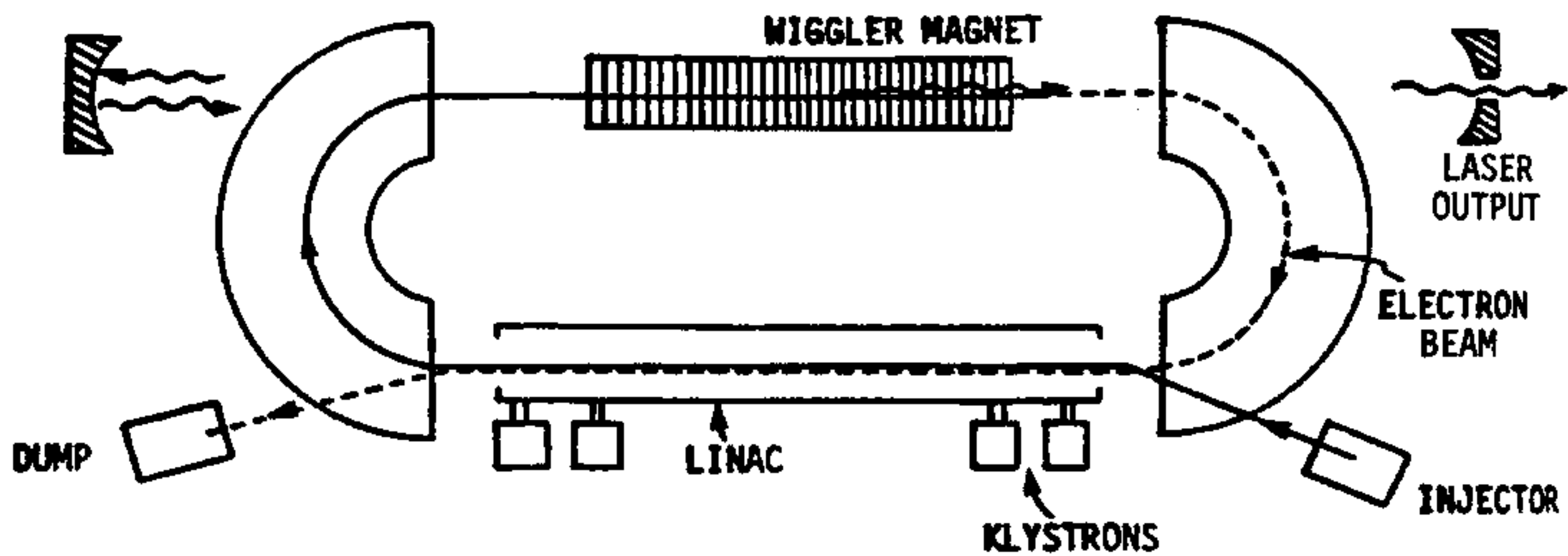

Figure 2. The CATALAC Free Electron Laser Concepts

CONCLUSIONS OF THE HUNTSVILLE SPS POWER CONVERSION WORKSHOP

J. Richard Williams
Associate Dean of Engineering
Georgia Institute of Technology
Atlanta, Georgia 30332

The National Aeronautics and Space Administration sponsored a workshop on "SPS Energy Conversion and Power Management" February 5-7, 1980. The workshop was hosted by the Johnson Environmental and Energy Center of the University of Alabama in Huntsville. The three topics under consideration were SPS Photovoltaic Power Systems, SPS Solar Thermal Power Systems, and Power Distribution and Management.

The photovoltaic working group chaired by Martin Wolf of the University of Pennsylvania examined the current status of SPS photovoltaic R&D and made recommendations for future programs. The examination was carried out from the viewpoint that the SPS will need to become a cost-effective electrical power source in competition with fossil and nuclear fueled base-load plants, as well as with various types of future terrestrial solar photovoltaic power systems. A number of important design parameters are interdependent, for example cell efficiency, thickness, and radiation resistance. The development of suitable candidate cell/blanket designs meeting the combined performance/mass/life design parameters, as verified in ground tests, should precede space certification testing and the development of manufacturing methods.

The group concluded that adequate resources are available for both the GaAs and silicon photovoltaic systems, and identified performance demonstration issues which need further work. Near term performance goals should be achievement of 16% efficiency in a suitable cell/substrate/cover structure to permit initiation of stability tests. Achievability of 16% end-of-life efficiency (for GaAs) and 14% end-of-life efficiency (for silicon) after 30 years will need to be demonstrated. Synchronous orbit flight tests should be planned for the post-1986 time frame. Efforts should continue aimed at demonstrating a 25% efficient AMO thin-film cascade solar cell and showing a potential for 35% efficiency. Also alternative concepts leading to 50% conversion efficiency should be pursued because of the enormous advantages of increasing photovoltaic efficiency, thereby reducing the size required for the array. Other major issues are cell encapsulation and blanket integration. The geometry of the blanket submodules, very thin and very large, requires new approaches and innovative techniques for fabrication in space. A critical component of the photovoltaic system is the supporting element or encapsulant to which the active element, the photovoltaic cell, is bonded. The encapsulation material has to provide the structural strength of the blanket and the shielding for the solar cells against the energetic particle radiation of space. Development of encapsulants with simultaneous durability against bombardment by electrons and protons, ultraviolet radiation, and deep thermal cycling for a 30 year period is essential to the program. Appropriate cost studies should also be conducted to ensure that the total array structure (cell, contacts, encapsulant, interconnects) is capable of meeting the SPS cost goals with suitable development and scaling.

Since some of the environmental factors are ill-defined and time varying, adequately instrumented on-orbit testing will be necessary to demonstrate the feasibility of achieving cost/performance/lifetime goals. The low mass of the blanket causes very severe temperature cycling during eclipse periods, with consequent stress due to thermal expansion coefficient mismatches in the blanket structure. The extent of these effects can be determined in ground-based thermal cycling tests, and the design, if needed, improved by selection of more suitable materials.

The one specific advanced concept recommended by the group for further immediate development is the cascaded or tandem multiple-band-gap solar cell - a concept already being investigated in several materials systems under Air Force

sponsorship for various space power supply requirements, and under DOE/SERI sponsorship for high efficiency terrestrial concentrator cell applications. This technology should be extended with specific orientation for the SPS, which includes the added specification of a limited substrate or encapsulant mass. Other advance concepts which should also be investigated include split-spectrum systems, thermophotovoltaic converters, and combined thermal and photovoltaic systems.

There are a variety of solar thermal options that have been investigated as possible alternatives to photovoltaic conversion. The advantages of solar thermal systems include insensitivity to radiation effects, simpler power conditioning, and the potential for high efficiency. Concern has been expressed that the current overwhelming emphasis on the photovoltaic approach could lead to insufficient examination of promising solar thermal options. Energy conversion systems considered by the solar thermal working group headed by Abraham Hertzberg included Breyton, potassium Rankine, cesium/steam combined cycles, organic Rankine, and thermionic. Applicable concentrators include parabolic dishes, compound parabolic concentrators, faceted reflectors, cassegranian concentrators, low concentration planar reflectors, and inflated structures. Both heat pipe and tube-fin radiators were considered. It was concluded that all the possible concepts require substantial advances in technology in order for the goals set for SPS to be achieved. Because of this, none of the concepts has such low risk that it can be relied upon to the exclusion of the others. Extremely high reliability can be achieved with solar thermal systems by the use of frictionless bearings (gas bearings) for rotating equipment and a large number of redundant power generation modules.

POWER TRANSMISSION AND RECEPTION - AN OVERVIEW AND PERSPECTIVE
R. H. Dietz
NASA/Johnson Space Center, Houston, Texas 77058

As part of the DOE/NASA Concept Development and Evaluation Program, NASA has been actively involved in conducting the SPS systems definition effort as well as undertaking certain critical technology supporting investigations. Definition and assessment of the Power Transmission and Reception System has been an important part of that activity. Although funding levels have been low, a considerable body of work has been developed which will provide an excellent data base for future activities in this area. Investigations into concepts for power transmission and reception have primarily concentrated on microwaves as a transport means, although preliminary laser concepts have recently begun to be analyzed. (Candidate lasers systems, e.g. electric discharge, indirect optically pumped, and free electron lasers, are currently under evaluation for overall SPS integration feasibility.) The remainder of this paper addresses the Microwave Power Transmission and Reception (PTAR) System activities.

System evaluation activities can be categorized into three major areas. First, microwave system studies (includes the portion of the overall SPS system definition studies which concentrated on the microwave system) funded for approximately \$825K. Second, independent subsystem studies (e.g. phase control, power amplifiers, etc.) funded for approximately \$890K. And third, experimental critical supporting investigations funded for approximately \$790K. The completed results of these funded efforts were presented and discussed as part of the peer review process at the SPS Workshop on Microwave Power Transmission and Reception, held at the Johnson Space Center, January 15-18, 1980.

Microwave PTAR can be accomplished in a variety of ways. Five options are illustrated in Figure 1. The power amplifiers (RF converters) can either be located on a separate antenna (separate from the photovoltaic array) or can be an integral part of the photovoltaic array. In turn, the separate antenna can be designed to accommodate all three types of power amplifiers; linear beam tubes, crossed-field tubes, or solid state devices. The integrated photovoltaic/power amplifier option can have either an optical reflector or an RF reflector. The RF reflector option has been dropped from the present studies because of the difficult technology development requirements anticipated in the RF waveguide and reflector areas.

The separate antenna approach was the basis for development of the present SPS Reference System. The concept for the Microwave PTAR System transmitter is shown in Figure 2. In this concept the linear beam klystron is used to convert from DC to RF energy. The 70 KW klystron, together with a cooling system, slotted waveguide radiators, phase control receiver and conjugation electronics, and other necessary hardware, comprise the transmit antenna's power module. There are 4 to 36 power modules in an antenna subarray depending on where the subarray is located across the overall tapered antenna array. There are 7220 subarrays in the 1 km. diameter array.

Basic system sizing was determined from several constraints and assumptions; a maximum thermal limit on the transmit antenna of 21 kW/m², a maximum power density through the ionosphere of 23 mW/cm², current projections of microwave system efficiencies, and minimum cost of electricity per kilowatt hour.

The receiving antenna array (rectenna), on the ground is characterized by immediate rectification from RF to DC. A typical configuration is shown in Figure 3. Individual dipole antennas are used as the receiving element and since rectification takes place immediately, DC power is collected from each element and fed into parallel and series strings to build up the voltage and current levels. Figure 4 illustrates the overall microwave PTAR concept showing subsystem inter-relationships in both the transmit and receive arrays.

Since the reference concept was developed, new interest has been generated in utilizing solid state power amplifiers, primarily because of the anticipated increase in reliability over the klystron. As shown in Figure 1, these can be used in either the separate antenna approach or in the optical reflector/sandwich approach. To the depth studied it appears that cost per kilowatt may be somewhat higher than the reference system, although as cost estimates have been refined, the costs have trended toward convergence.

As a result of the evaluations to date in the Concept Development and Evaluation Program, there are certain conclusions which can be reached on the Microwave PTAR System. One overall conclusion is that the transfer of gigawatt power levels between two points using microwaves is feasible. Other conclusions of a more detailed nature were presented at the system workshop previously mentioned. Also identified were certain remaining issues which must be addressed if the system concepts are to be more fully understood.

Results of the workshop will be presented in another session paper. Other session papers will present results of the SPS program evaluations on the Microwave PTAR System.

Figure 1

NASA Solar Power Satellite

Microwave System Options

RF Converter	Antenna mounted	Solar cell mounted (concentration ratio = 3)		
		• Optical reflector	• RF reflector	
				
SPS Design	Klystron or CFA	Solid state	Solid state	Solid state
Power output to grid	5 GW	2.5 GW	0.7 GW	0.2 GW per km ² solar cells
Space antenna diameter	1 km	1.4 km	2.7 km	High power waveguide
Rectenna diameter at 23 mW/cm ²	10 km	7.1 km	3.8 km	Not determined
Antenna	10 dB taper	10 dB taper	Uniform	Advanced horn feb paraboloid

Figure 2

NASA Solar Power Satellite

Microwave Power Transmission Design Concept

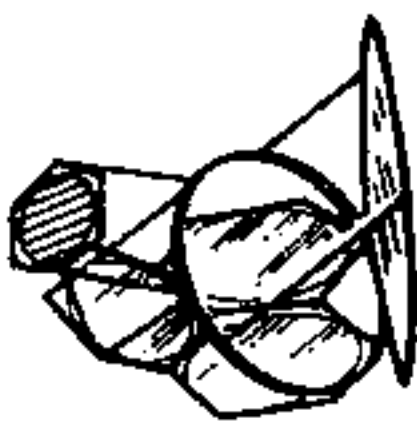
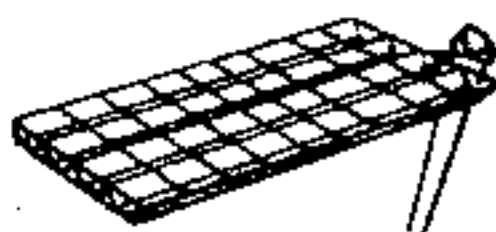
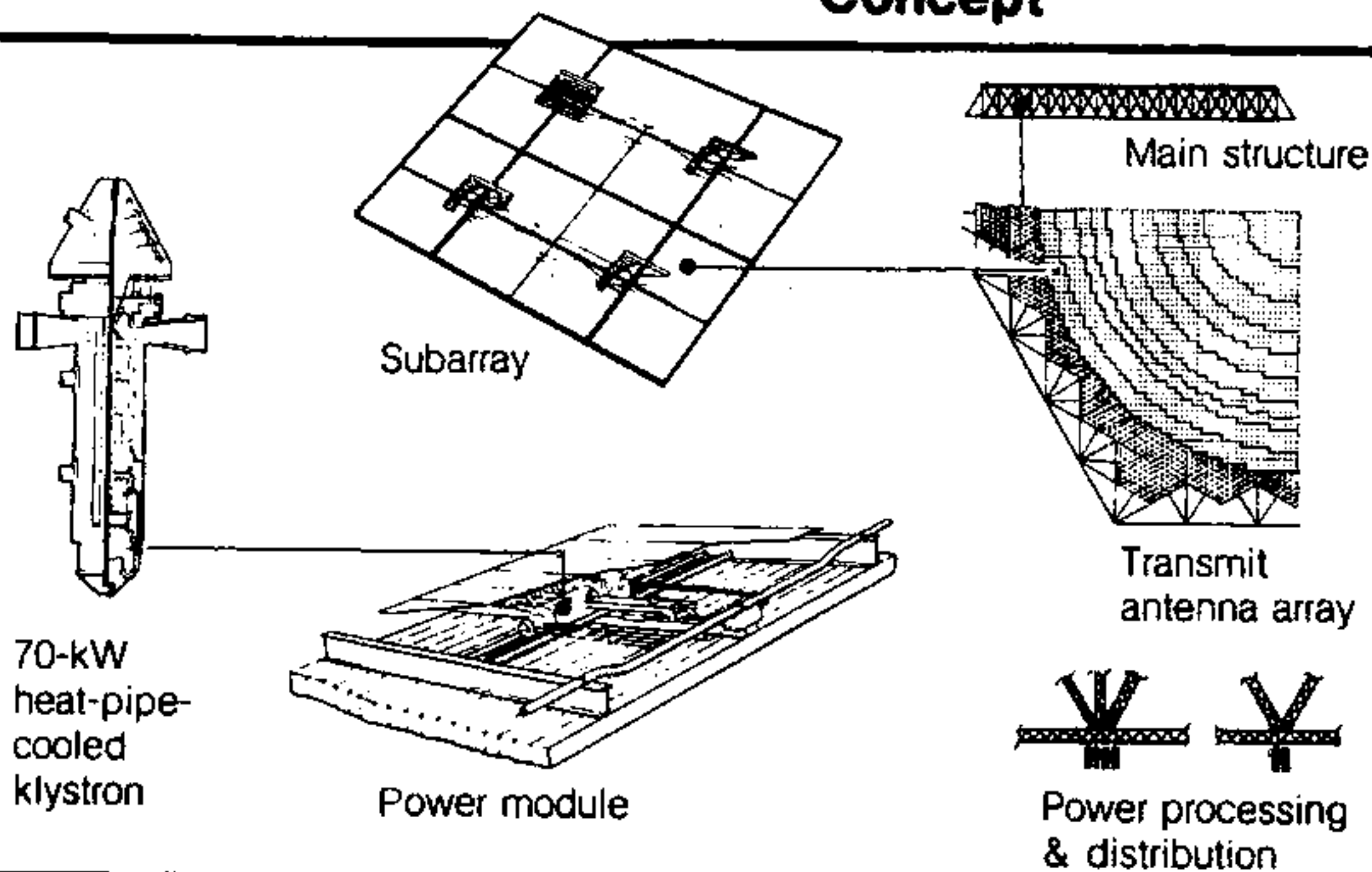

NASA

Solar Power Satellite

Figure 3

Typical Configuration
Rectenna

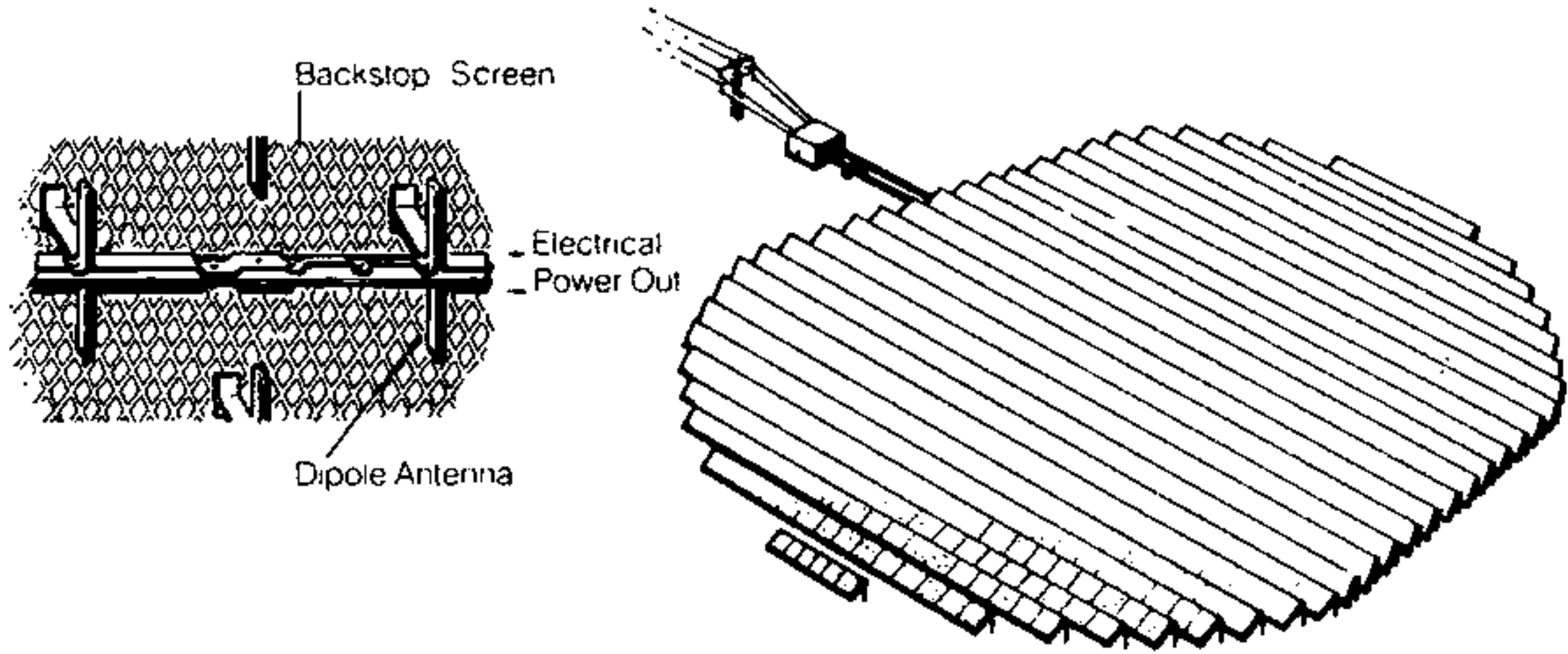

NASA

Solar Power Satellite

Figure 4

Microwave System

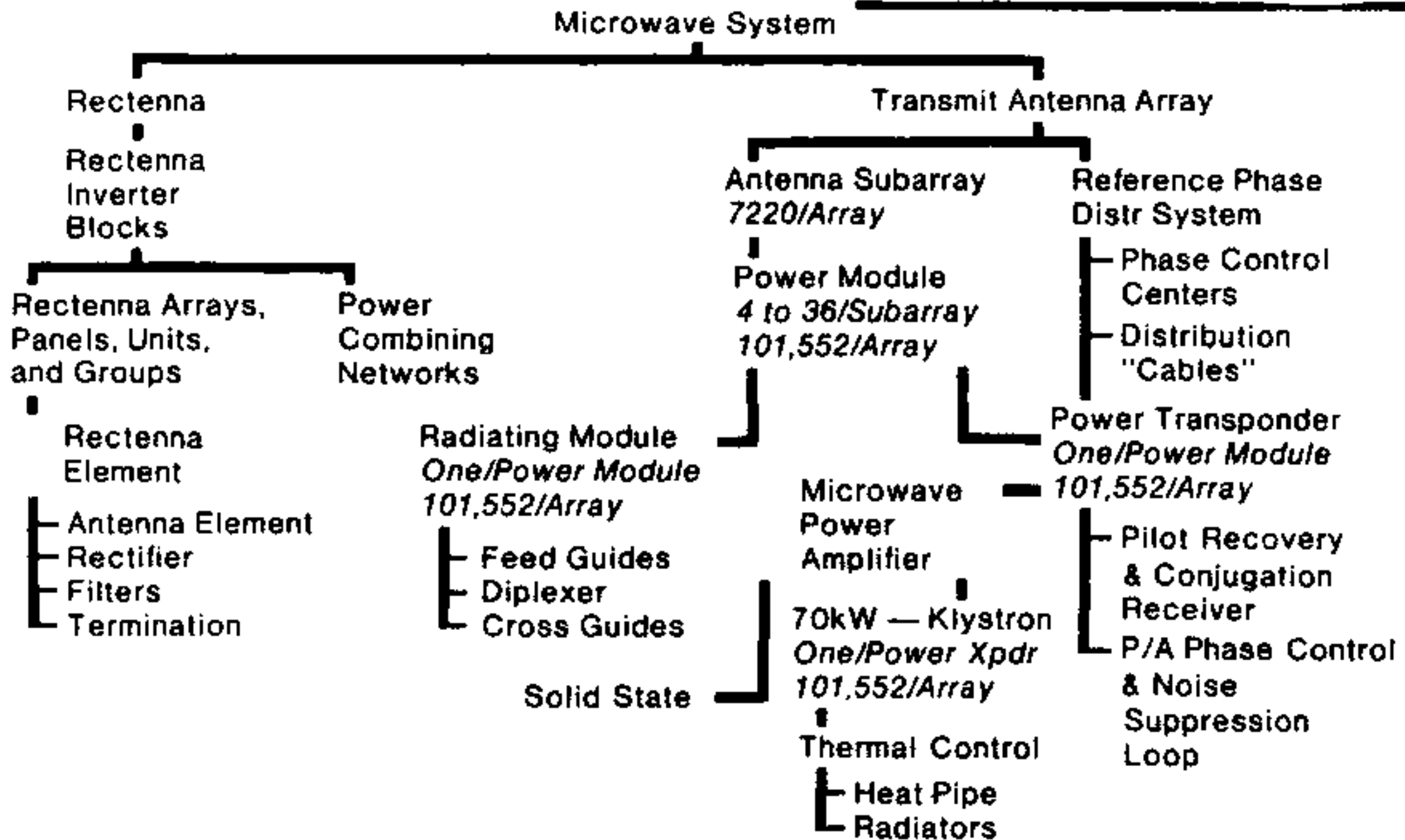

MICROWAVE SYSTEM PERFORMANCE SUMMARY

G. D. Arndt - NASA/Johnson Space Center, Houston, Texas

E. J. Nalos - Boeing Company, Seattle, Washington

Introduction: The SPS microwave system as defined in the October 1978 Reference System Report, DOE/ER-0023, has a 1 Km diameter phased array antenna with a 10 dB gaussian taper illumination which focuses the beam at the center of the ground antenna/rectifying system (rectenna). The power beam has approximately 88% of its energy within a 5 Km radius from the rectenna boresight, with a resultant beam width of 1.2 arc-minutes. Mechanical alignment of the 1 Km antenna is maintained within one arc-minute while electronic alignment has a 1.8 arc-second accuracy. The DC-RF power converters within the antenna are 70 KW klystrons fed by 40 KV power lines from a series/parallel solar array configuration. The antenna is divided into 7220 mechanical subarrays, 10.4 meters x 10.4 meters on a side, having slotted waveguides as the radiating surface. Slotted waveguides were selected because of their high power handling capabilities and low I^2R losses.

The klystrons will be phase controlled at the individual tube level through the use of a retrodirective pilot beam signal transmitted from the center of the rectenna and phase conjugated in receivers in each power module. An onboard phase reference signal is distributed through the antenna to provide the same reference in each conjugating receiver. The reference phase distribution system is implemented in the form of a four level tree structure with electronic compensation for minimizing phase shifts due to unequal path lengths from the center of the transmit antenna to each phase control receiver. The uplink pilot beam signal has a double sideband, suppressed carrier with code modulation to provide link security and anti-jamming protection from radio frequency interference.

The ground rectenna converts the RF energy to DC electricity using halfwave dipoles feeding Schottky barrier diodes. Coherence of the incoming phase front needs to be maintained only over the area associated with a small group of dipoles. Physically the present rectenna configuration is a series of serrated panels perpendicular to incoming beam and covers approximately 75 square kilometers. A 75-80% optical transparency of the panels allows other utilization of the area beneath the rectenna if so desired.

The SPS sizing of the 1-Km transmit antenna and 5 GW of DC output power from the rectenna is based upon a 23 KW/m² heat dissipation limit in the antenna and a hypothetical 23 mW/cm² peak power density limit in the ionosphere to prevent non-linear heating. System sizing tradeoffs given in another paper in this session indicate the ionospheric limit is a critical design and costing parameter. This limit may be revised upward pending the completion of the Department of Energy Environmental assessment studies on ionospheric heating.

Recent Study Results: Several changes in the microwave system are now recommended as a result of recent NASA and contractor studies. These modifications to the reference system documented in the aforementioned October 1978 DOE/NASA report include:

- Phase control to the power module (tube) level. It is recommended that phase conjugation be performed at each of the 101,000 power modules rather than at the 7,220 subarrays. The advantages of phase control at the tube level is a reduction in the antenna and subarray mechanical tilt requirements (or a reduction in scattered microwave power if the same tilt requirements are maintained) and a reduction in the effects of distributed phase errors within the subarrays. The disadvantage is increased costs due to the 94,000 additional phase control receivers. In the May 1979 SPS Microwave Symposium in Washington, D. C. it was reported that an overall cost savings could be achieved (i.e., the cost benefits

of less scattered power were greater than the additional receiver costs) if the phase control receivers were less than \$600 each. A later Boeing Aerospace Company study indicates that these receivers can be built for less than \$600 in high volume quantities. There is also an environmental advantage in phase controlling at the power module level in that the grating lobes incident upon the earth are reduced in amplitude and in quantity. Figures 1 and 2 show the locations and amplitudes of the grating lobes from a single 5 GW SPS system with phase control to the power module level. Recent simulation results indicate the off-axis grating lobes may be considerably reduced from the data shown in the figures.

The location jitter or the error in path length from the pilot beam transmitter to each radiating slot in the antenna is reduced by going to the smaller antenna size associated with an individual tube rather than to the larger subarray. This location jitter, which appears as a phase error, scatters 6 MW of power at the tube level as compared to 87 MW at the subarray level.

- A reduction in allowable amplitude jitter. The reference SPS system has a ± 1 dB amplitude jitter across the surface of each subarray or power module. Analysis results indicate that power transfer efficiency (88% for the reference system) is relatively insensitive to amplitude jitter. However the voltage and amplitude regulations for the high efficiency, high gain klystron tubes have to be maintained to approximately 1% for satisfactory operation. Therefore a $\pm 1\%$ amplitude tolerance is recommended for the antenna error parameter. This change will not affect the microwave transmission efficiency budget.

- Metal matrix waveguides. The SPS reference system has aluminum for the subarray distribution and radiating waveguides. Because of thermal distortion problems a graphite/aluminum metal matrix composite is now being developed as a possible replacement for the aluminum.

The antenna structural members are composed of a high-temperature graphite plastic material for rigidity. The antenna primary structure has a 1040 meter x 1040 meter x 100 meter pentahedral truss configuration which supports a secondary structure. This secondary structure provides a base for mounting and aligning the transmitter subarrays. Both the primary and secondary structures must maintain a high degree of stability over wide operating temperature fluctuations to preserve the three arc-minute flatness requirement, hence the need for low coefficient of thermal expansion materials.

- Startup/Shutdown Procedure. The satellite will have to shut down 87 times per year due to solar eclipses by the earth. In addition there will be eclipses by the moon and other SPS, as well as scheduled shutdowns for maintenance. A number of possible sequences for energizing/deenergizing the microwave system were investigated. Three sequences provided satisfactory performance in that the resultant sidelobe levels during startup/shutdown were lower than the steady-state levels present during normal operations. These three sequences were: random, incoherent phasing, and concentric rings-center to edge. Thus no microwave radiation problems are anticipated during startup or shutdown operations, either scheduled or unscheduled.

Shaped Beam Synthesis: Studies into reshaping the beam pattern to improve overall antenna collection efficiency and to provide additional means of sidelobe control were undertaken. These studies included: (1) Adding phase reversal at the klystron input as a first step towards a continuously variable phase distribution across the antenna surface. The results showed that reshaped beam patterns

into "squared" main beams are possible with both reverse and continuous phase tapers. However the penalty is an increased antenna size or a larger rectenna. (2) Adding suppressor rings to the antenna for reducing the first few sidelobe levels. Results indicate a 5 dB reduction in sidelobe levels at the expense of a loss in rectenna collection efficiency. Larger antennas or rectennas are again needed to retain the 88% rectenna collection efficiency. (3) Quadratic phase tapers. The analyses showed a decrease in on-axis power density (i.e., a squared beam) with a corresponding loss in beam transfer efficiency, dependent upon the amount of phase taper introduced. (4) Multiple antenna beams. The transmission of multiple beams from a single antenna is possible by spatially modulating the illumination function. Results for a simple two-beam SPS system were as predicted except for a small residual central lobe. Elimination of the central peak is a goal for future studies in this area.

Summary: The characteristics and error parameters of the updated microwave transmission system may be summarized as follows:

Frequency	- 2.45 GHz
Output Power to Power Grid	- 5 GW (DC)
Transmit Array Size	- 1 Km Diameter
Power Radiated from Transmit Array	- 6.72 GW
MPTS Efficiency	- 63% (DC/RF Input to RF/DC Output)
Array Aperture Illumination	- 10 step, truncated gaussian amplitude distribution with 10 dB edge taper
Peak Microwave Power Density in Ionosphere	- 23 mW/cm ²
Phase Control	- to power module level
Waveguide material	- metal matrix composite
Error Budget:	
Total RMS phase error per power module	= 10°
Amplitude tolerance per power module	= ±1%
Failure rate of DC-RF power converter tubes	= 2% (a maximum of 2% failed at any one time)
Antenna mechanical alignment	- one arc-minute
Subarray mechanical alignment	- three arc-minutes

The relative importance of these electrical and mechanical tolerances upon scattered microwave power (extra power not incident upon the rectenna) is summarized in Figure 3.

FIGURE 1. GRATING LOCATIONS FOR A SINGLE BEAM

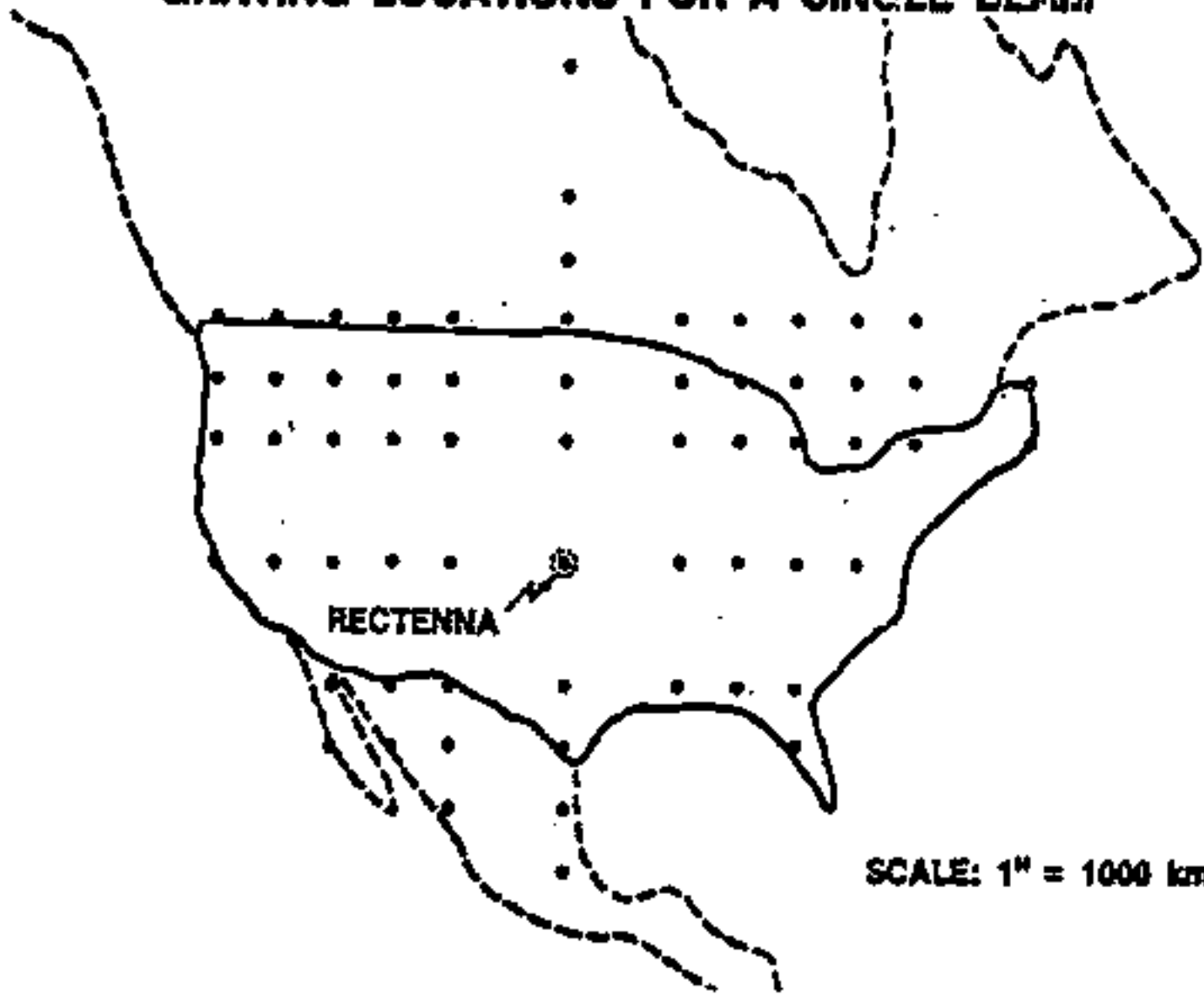

FIGURE 2. GRATING LOBE PEAKS FOR 10 METER SUBARRAYS AND PHASE CONTROL TO POWER MODULES (TUBES)

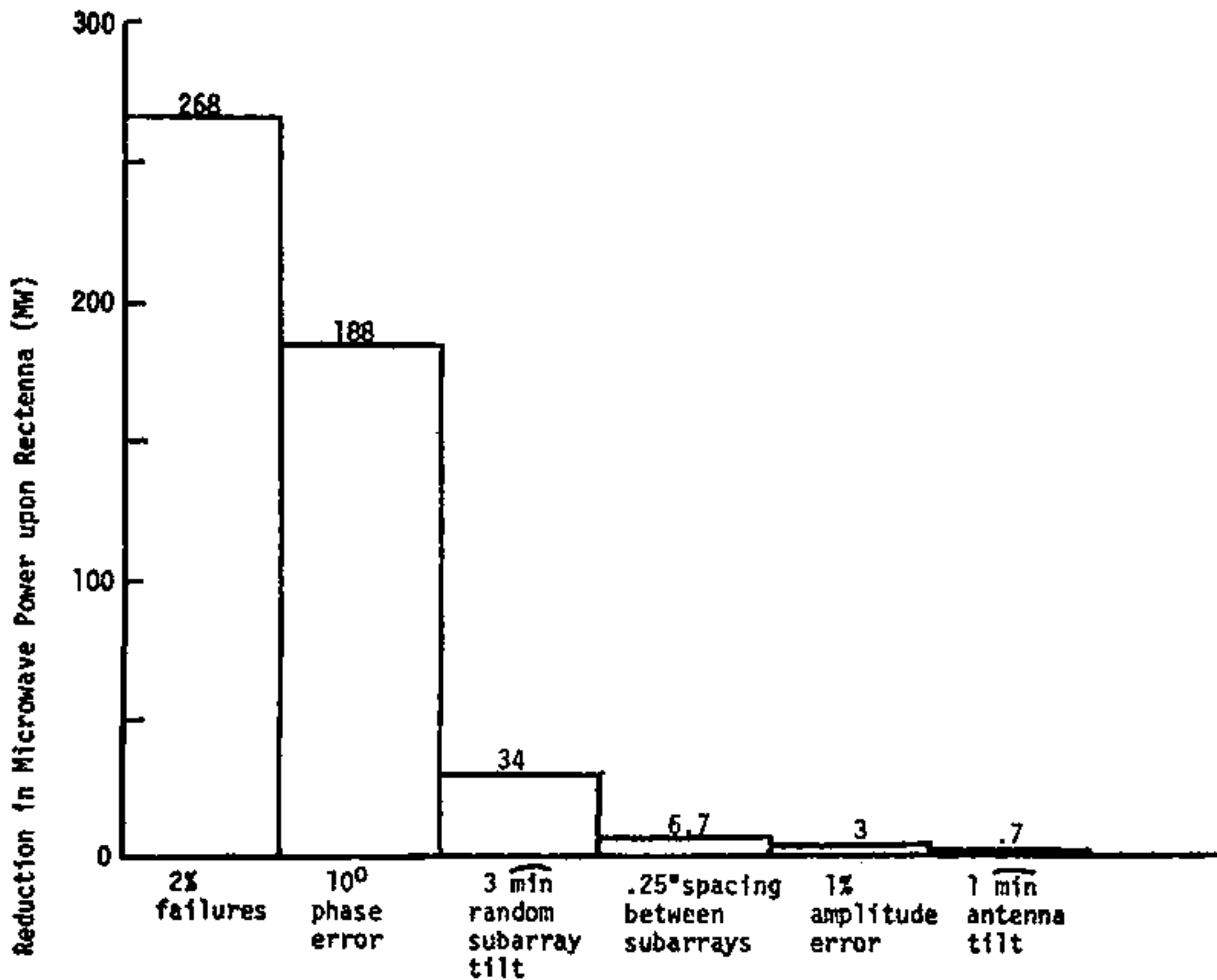
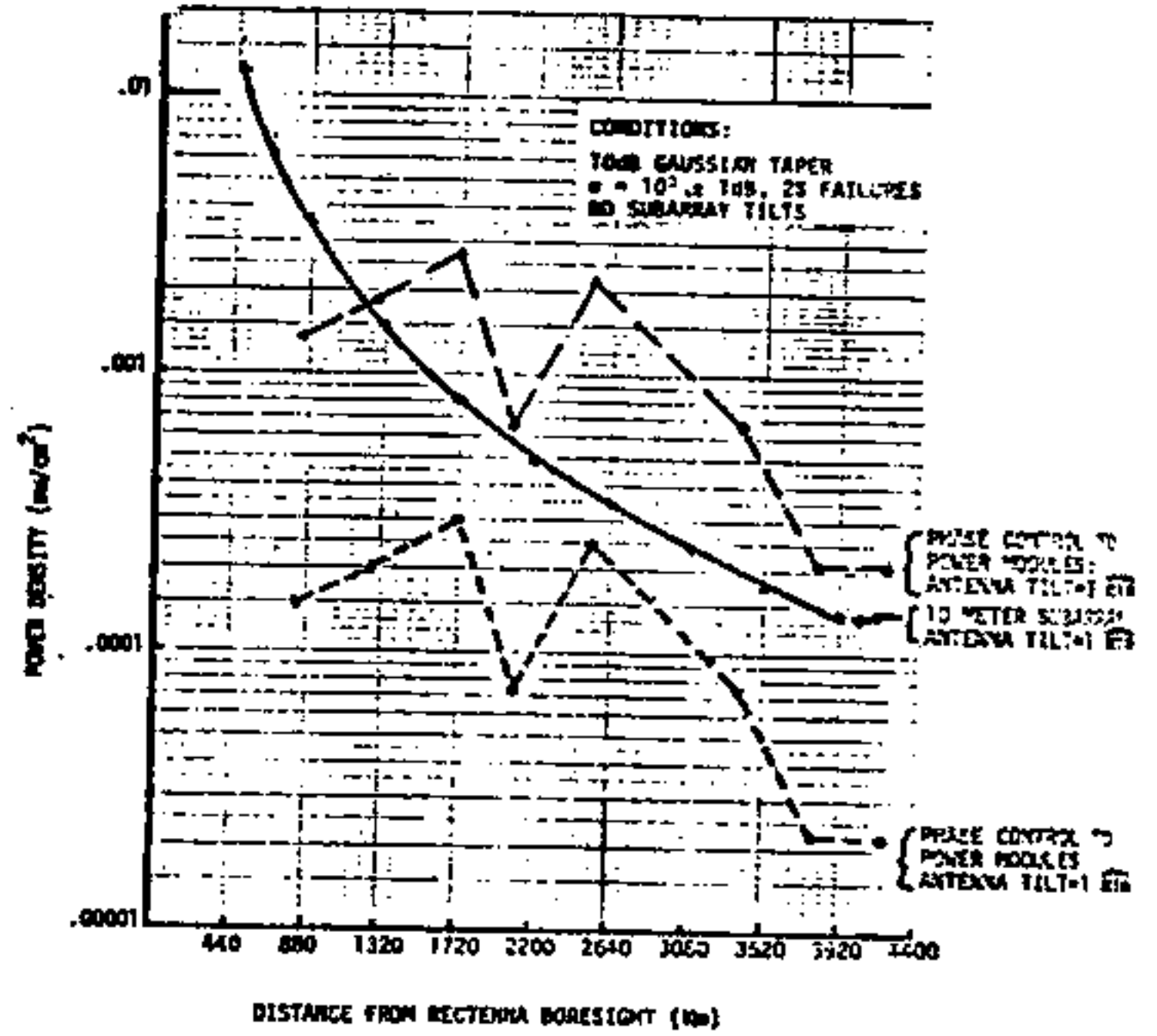

Figure 3. Reduction in Microwave Power due to Electrical and Mechanical Errors (Power Module Level Phase Control)

SATELLITE POWER SYSTEM CONCEPT DEVELOPMENT AND EVALUATION PROGRAM
CRITICAL SUPPORTING INVESTIGATIONS
"SUMMARY"

J. W. Seyl
NASA/Johnson Space Center - Houston, Texas

The Department of Energy (DOE) and the National Aeronautics and Space Administration (NASA) are conducting a broad assessment of the Satellite Power System (SPS) under the Concept Development and Evaluation Program which started in 1977 and will be completed in 1980. This program is intended to assess the SPS concept from a technical, environmental, social and economic viewpoint, to compare it with other advanced energy possibilities, and to make recommendations for future efforts. During this program, NASA has been primarily involved in the system definition area which is aimed at defining a reference system for which the various assessments can be made. In addition, NASA is assessing the impact of emerging technologies on the SPS concept and conducting critical experimental and analytical supporting investigations when required. The NASA has conducted parallel system studies with the Boeing Aerospace Company and Rockwell International to define overall system concepts and operational scenarios. In addition, several independent contracts have been awarded by NASA to investigate specific critical technology areas in more depth than can be accomplished in a system level contract. The majority of these investigations have been accomplished through individual government sponsored contracts of less than \$100K in magnitude. The nine (9) specific tasks which fall into this category are listed below:

(1) Design and breadboard evaluation of the SPS reference phase control system concept, Lockheed Engineering and Management Services Company, Inc., (LEMSCO); (2) SPS fiber optics link assessment, Boeing Aerospace Company; (3) Eight element S-band active retrodirective array, Jet Propulsion Laboratory (JPL); (4) SPS antenna element evaluation, Boeing Aerospace Company; (5) SPS solid state antenna power combiner, Boeing Aerospace Company; (6) SPS solid state amplifier development program, Radio Corporation of America (RCA); (7) SPS magnetron tube assessment, Raytheon Company; (8) Microwave Ionosphere Interaction experiment, Applied Research Laboratory, University of Texas at Austin; and (9) Solid state sandwich concept design consideration and issues, Raytheon Company.

The major objectives established in each of the above tasks and their present status and findings cannot be presented in this short paper. However, two examples will be given to illustrate the type of investigations which are representative of these tasks.

The Boeing Aerospace Corporation was awarded a \$30K contract by the Johnson Space Center (JSC) to assess the potential application of fiber optic transmission links for the phase reference signal distribution across the SPS one kilometer antenna. Initially, analytical evaluations of various types of emitters and detectors and various fiber characteristics were made. Four

fibers were selected for testing along with an injection laser diode for the emitter and an avalanche photodiode for the detector. Figure 1.0 shows the laser link configuration which was fabricated and tested prior to delivery to the JSC for future system testing with the Master Slave Returnable Timing System (MSRTS). The MSRTS provides electronic compensation for phase variations in the reference signal that are introduced by transmission path length differences and/or variations.

A second example is the \$100K contract with the Radio Corporation of America (RCA), awarded by the Marshall Spaceflight Center through Rockwell International. This task effectively continued an earlier investigation which RCA had initiated under contract to JSC for evaluation of potential solid state amplifier design requirements and characteristics. Several commercially available solid state devices were considered and some were experimentally evaluated. The Gallium Arsenide field effect transistors appear to be the most promising at the present time to achieve the high efficiency, high power (5 watts) required for SPS applications. The present task involves further analytical and experimental evaluations of both the solid state device and its associated power amplifier circuitry. Computer modeling and simulation for synthesizing current and voltage waveforms under large signal operating conditions have been developed. These analytical techniques are used to define available tradeoffs for optimizing efficiency and output power for the solid state amplifier. Figure 2.0 shows some typical experimental results using off-the-shelf commercially available FETS. In one instance when optimized for maximum efficiency, a 71% power-added efficiency was achieved. However, tests of similar devices from the same manufacturer but rated for slightly less output power resulted in efficiencies of much less (~60%). The incongruity in these results are under intensive investigation in hopes to shed more light on the underlying causes of efficiency degradation. These experiments along with updated analytical models and computer simulations should provide the basis for device and circuit design parameter specifications to achieve the high power, high efficiency operation necessary.

The other tasks noted previously each represent an advance in the technology base of one form or another and as a whole have added significantly to understanding the future satellite power system technological advances required.

References:

1. Lindsay, Thomas A., "SPS Fiber Optic Link Assessment", Boeing Aerospace Company, January 31, 1980.
2. Belohoubek, E. F., et. al., "Analysis of S-Band Solid State Transmitters for the Solar Power Satellite", Final Report, RCA Laboratories, June 1, 1979.

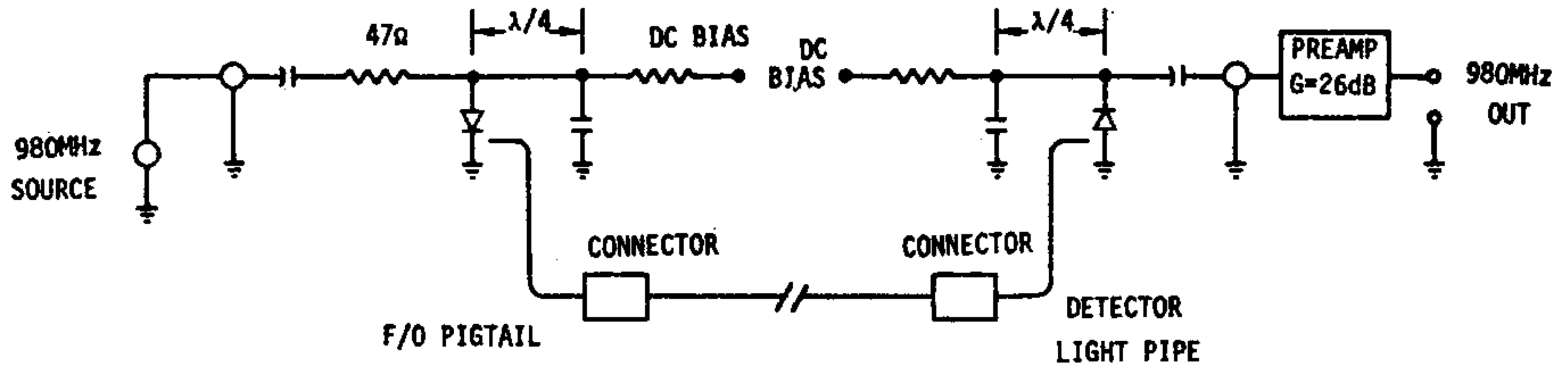
EMITTER

- NEC INJECTION LASER DIODE
- BIAS COUPLED THROUGH QUARTER-WAVE MICROSTRIP
- $I_{\text{BIAS}} = 88\text{ma DC}$
- OPTICAL POWER = 437 μwatt @ EMITTER DIGTAIL
- $V_{980\text{MHz}} = 0.7\text{ VOLTS RMS}$

FIBER

- CORNING IVPO, GRADED INDEX
- LENGTH = 303 METERS
- ATTEN. = 3.9dB/km
- BW = 870MHz-km
- N.A. = 0.218

DETECTOR

- RCA AVALANCHE PHOTODIODE
- BIAS COUPLED THROUGH QUARTER-WAVE MICROSTRIP
- $V_{\text{BIAS}} = 180\text{ VOLTS DC}$
- OPTICAL POWER = 228 μwatt @ DETECTOR LIGHT PIPE
- $V_{980\text{MHz}} = 135\text{ mv RMS OUT OF PREAMP}$

FIGURE 1 INITIAL SPS 980MHz FIBER OPTIC LINK CONFIGURATION

284

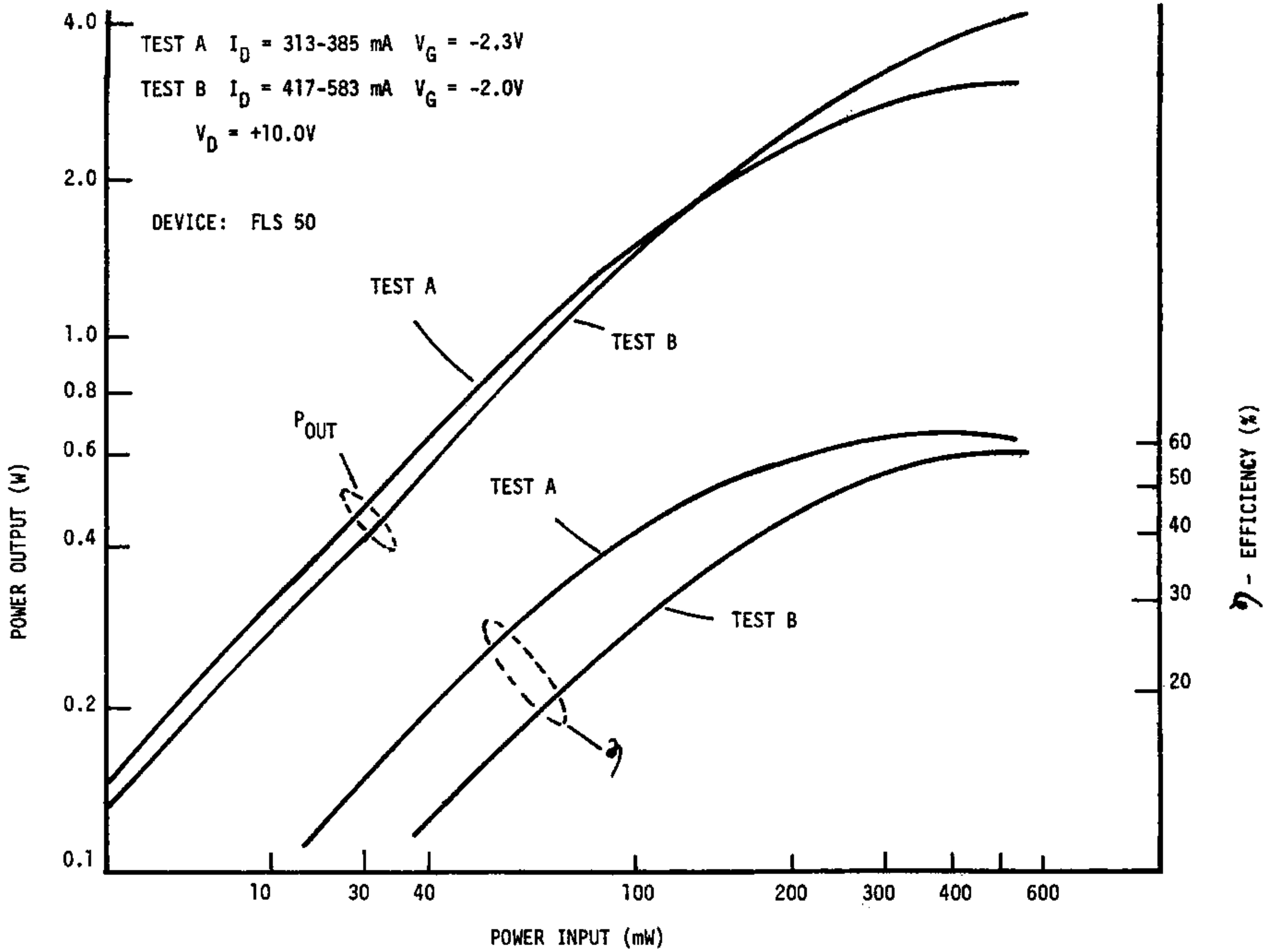

FIGURE 2.0 TEST RESULTS - MAX. POWER AND MAX. EFFICIENCY TUNING

PHASE CONTROL SYSTEM CONCEPTS AND SIMULATIONS

W. C. Lindsey

LinCom Corporation, P. O. Box 2793D, Pasadena, California 91105

This short paper provides a summary overview of the Solar Power Satellite (SPS) reference phase control system as defined in a three phase study effort under contract to the Johnson Space Center (see Refs. 1-5). It serves to summarize key results pertinent to the SPS reference phase control system design. These results are a consequence of extensive system engineering tradeoffs provided via mathematical modeling, optimization, analysis and the development/utilization of a computer simulation tool called SOLARSIM.

Figure 1 shows the system engineering viewpoint of the SPS transmitting system using the retrodirective phased array concept consisting of three major systems; viz., (1) The Reference Phase Distribution System, (2) The Beam Forming and Microwave Power Generating System and (3) The Solar Power to Electrical Power Conversion System. Figure 2 illustrates the Reference Phase Distribution and Beam Forming System.

The reference phase control system concept was presented in detail in Ref. 3; its major features are illustrated here. Based upon earlier study efforts (Refs. 3, 4), a phase control system concept has been proposed which partitions the system into three major levels. Figure 2 demonstrates the partitioning and represents an expanded version of Figure 1. The first level of phase control illustrated in Figure 2 consists of a reference phase distribution system implemented in the form of phase distribution tree structure. The major purpose of the tree structure is to electronically compensate for the phase shift due to the transition path lengths from the center of the spaceteenna to each phase control center (PCC) located in each subarray. In the reference system, this is accomplished using the Master Slave Returnable Timing System (MSRTS) technique. The detailed mathematical modeling and analysis of the MSRTS technique is provided in Ref. 4. Based upon extensive tradeoffs using SOLARSIM and appropriate analysis during the Phase II study, a four level tree is selected to be the reference phase distribution system configuration.

The second level of phase control consists of the Beam Steering and Microwave Power Generating System which houses the SPS Power Transponders. This transponder consists of a set of phase conjugation multipliers driven by the reference phase distribution system output and the output of a pilot spread spectrum receiver (SS RCVR) which accepts the received pilot via a diplexer connected to a separate receive horn or the subarray itself. The output of the phase conjugation circuits serve as inputs to the third level of the phase control system. The third level of phase control is associated with maintaining an equal and constant phase shift through the microwave power amplifier devices while minimizing the associated phase noise effects (SPS RFI potential) on the generated power beam. This is accomplished by providing a phase-locked loop around each high power amplifier, Figure 2.

REFERENCES

1. Lindsey, W. C., and Kantak, A. V., "Automatic Phase Control in Solar Power Satellite Systems," Prepared for NASA/JSC, TR-7809-0977, September 1977, LinCom Corporation, P.O. Box 2793D, Pasadena, CA.
2. Lindsey, W. C., "A Solar Power Satellite Transmission System Incorporating Automatic Beam Forming, Steering and Phase Control," Prepared for NASA/JSC TR-7806-0977, June 1978, LinCom Corporation, P.O. Box 2793D, Pasadena, CA.
3. Lindsey, W. C., and Kantak, A. V., "Automatic Phase Control in Solar Power Satellite Systems," Prepared for NASA/JSC, TR-7802-0977, February 1978, LinCom Corporation, P.O. Box 2793D, Pasadena, CA.
4. Lindsey, W. C., Kantak, A. V., Chie, C. M., and Booth, R. W. D., "SPS Phase Control System Performance Via Analytical Simulation, Phase II," Prepared for NASA/JSC, TR-7903-0977, March 1979, LinCom Corporation, P.O. Box 2793D, Pasadena, CA.
5. Lindsey, W. C., Kantak, A. V., and Chie, C. M., "SPS Phase Control Performance Via Analytical Simulation Phase III," Vols. I-IV, Prepared for NASA/JSC, TR-0180-0779, January 1980, LinCom Corporation, P.O. Box 2793D, Pasadena, CA.

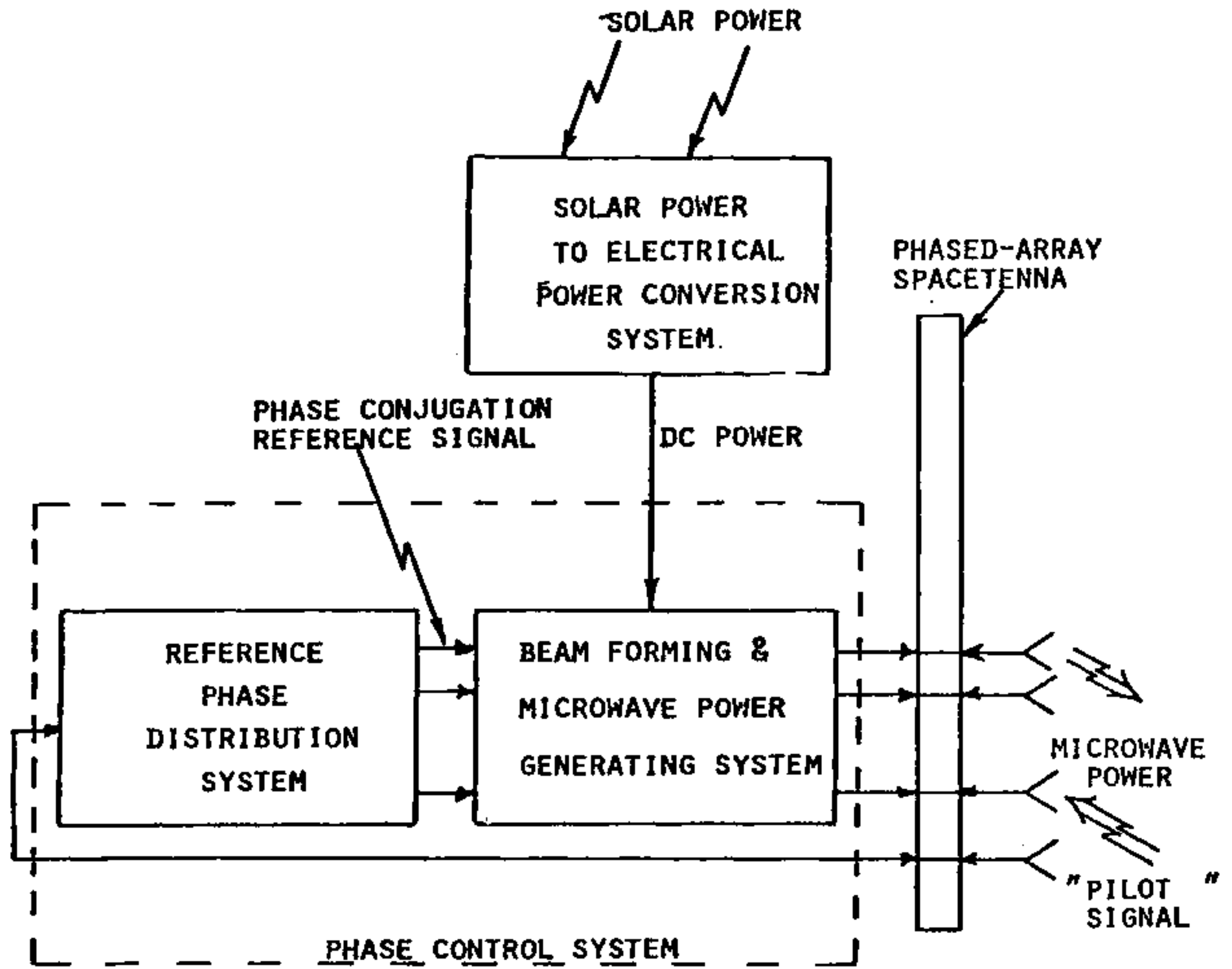

Figure 1. Solar Power Satellite (SPS) Transmission System (Phase Conjugation).

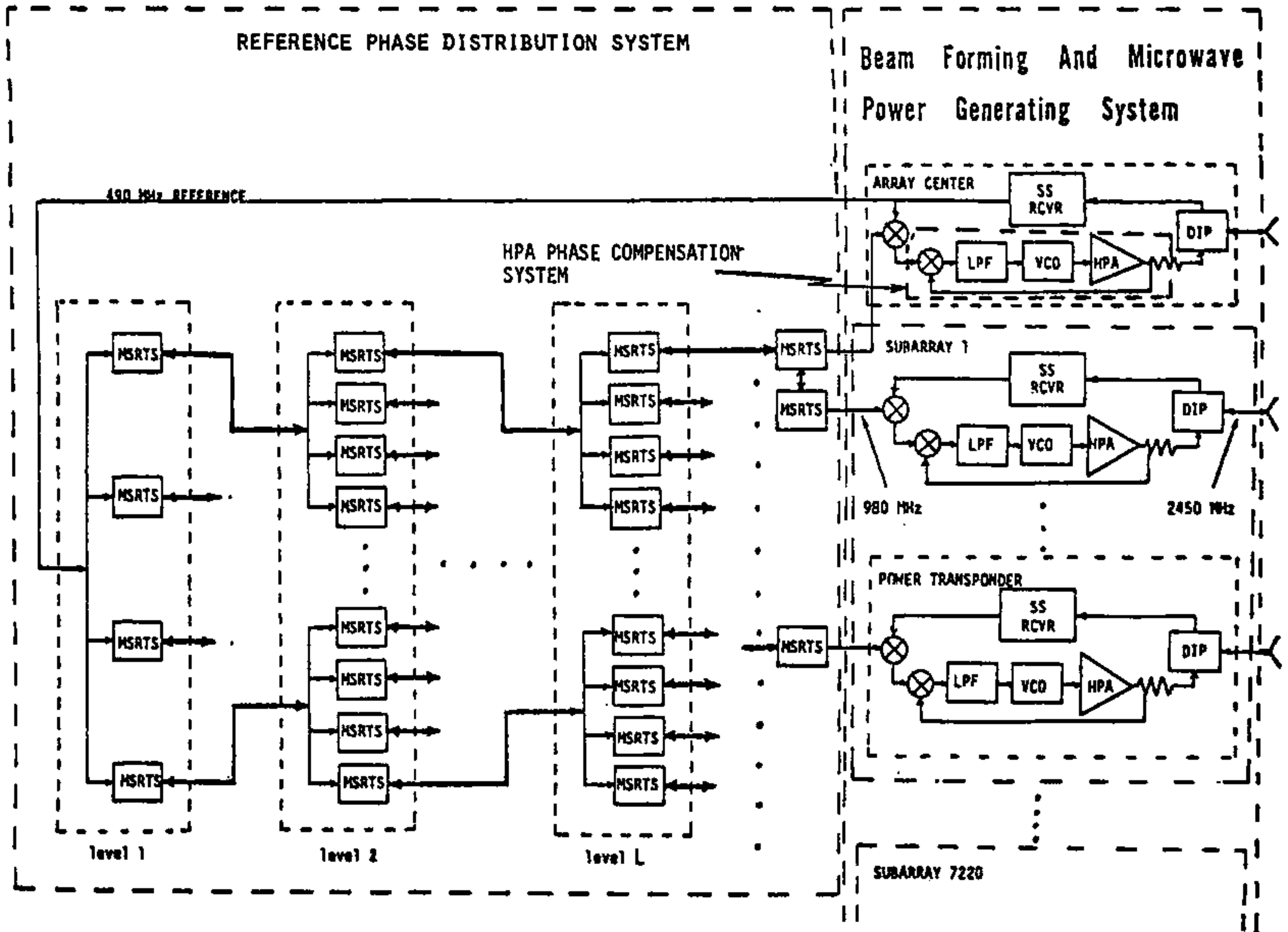

Figure 2. Reference Solar Power Satellite Transmission System.

AN INTERFEROMETER-BASED PHASE CONTROL SYSTEM
James H. Ott and James S. Rice
Novar Electronics Corporation, Barberton, Ohio

ABSTRACT

An interferometer-based phase control system for focusing and pointing the SPS power beam is discussed. The system is ground based and closed loop. One receiving antenna is required on earth. A conventional uplink data channel transmits an 8-bit phase error correction back to the SPS for sequential calibration of each power module. Beam pointing resolution is better than 140 meters at the Rectenna.

INTRODUCTION

Key to focusing and pointing the SPS power beam is the maintenance of precise phase relationships among the transmitted signals of each Spacetenna subarray. Specifically, the signals transmitted by each power module must arrive at the center of the Rectenna in phase. This results in a power beam having a planar wavefront pointed at the center of the Rectenna. However, structural deformations in the Spacetenna can, if not compensated for, alter the phases of the power module signals at the Rectenna by altering the path lengths of the signals between the power modules and the Rectenna. In addition, variations within the Spacetenna circuitry can also alter the phases of the signals.

Novar Electronics Corporation has developed an interferometer-based phase control system.¹ This approach, which we call Interferometric Phase Control (IPC), has three significant characteristics which differentiate it from the Reference System retrodirective approach.

1. Interferometric Phase Control is a ground based closed loop system. Unlike in the retrodirective approach, the phase correction information is obtained on earth by measuring the resultant power transmission of the Spacetenna power modules and comparing them against a reference.
2. The Spacetenna's power modules are calibrated sequentially. A signal from a reference transmitter near the center of the Spacetenna is sequentially phase compared with a calibration transmission of each of the power modules.
3. During normal power transmission, the frequency of each power module is shifted slightly during phase calibration. Maintenance of a properly focused and pointed power beam can be accomplished concurrently with the normal transmission of power from the SPS by using frequencies for calibration which are different from the power beam frequency.

SYSTEM DESCRIPTION

On or near the Rectenna site, an antenna called the Phase Measurement Antenna (PMA) receives signals from a transmitter located near the center of the Spacetenna, called the Spacetenna Reference Transmitter (SRT), and from the particular power module being phase tuned (calibrated). Analysis of these signals provides sufficient information to generate a phase error correction term which is sent up to the on-board phase control circuitry, shown in Figure 1, of the power module undergoing calibration.

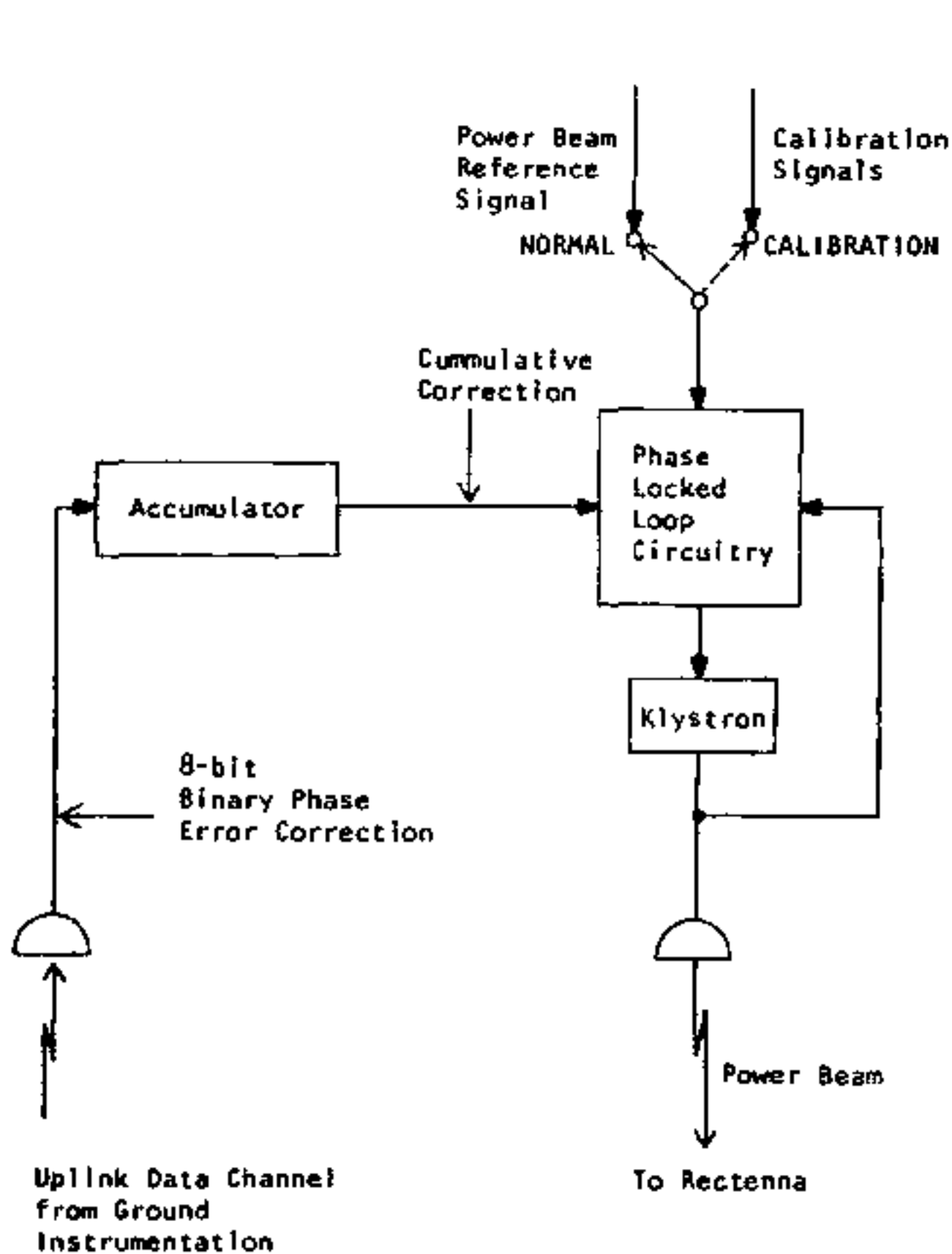
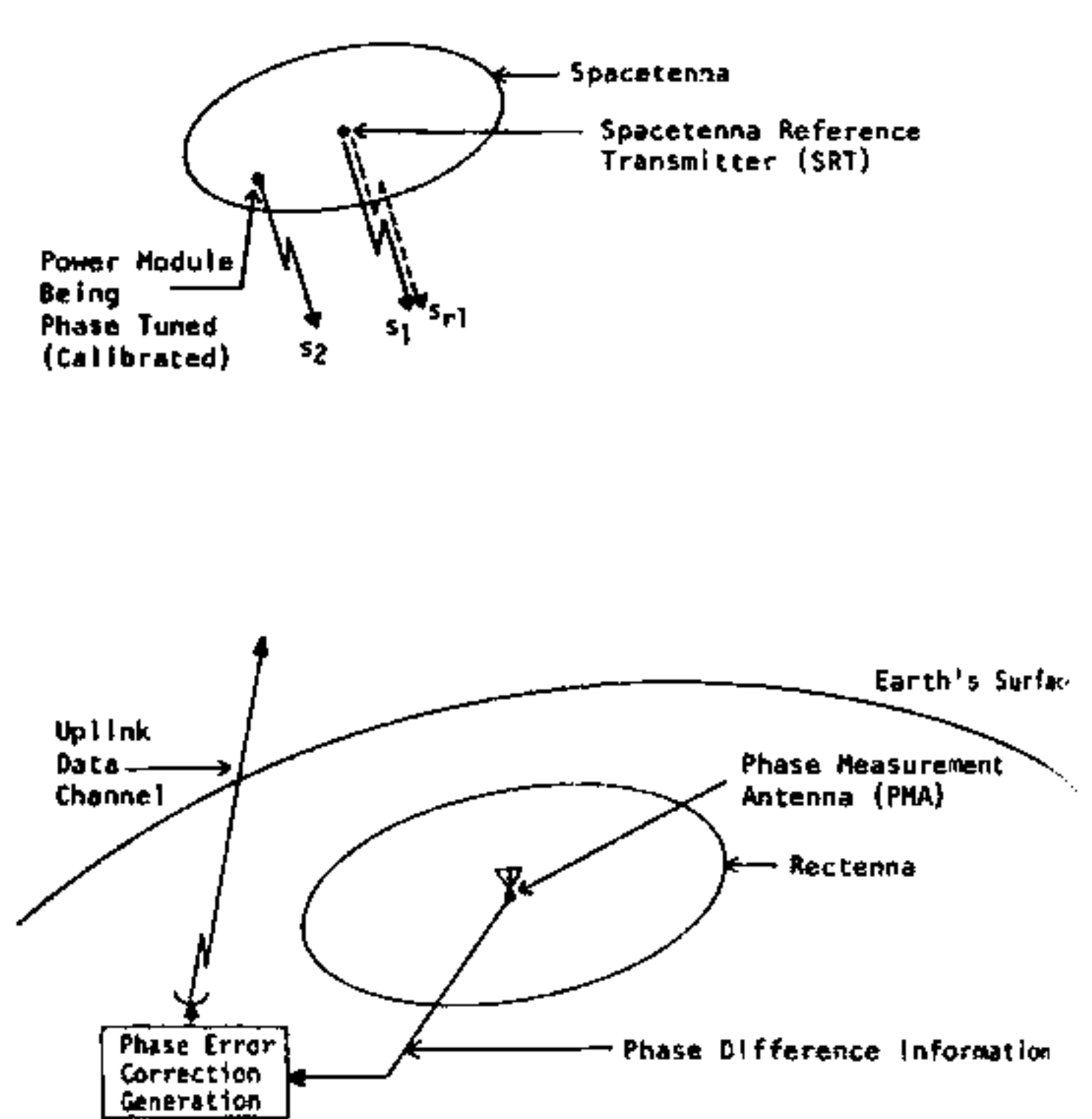

FIGURE 1
POWER MODULE PHASE CONTROL CIRCUITRY



Pictorial representation of relationship between Spacetenna signals and ground instrumentation.

FIGURE 2
INTERFEROMETRIC PHASE CONTROL

Phase Tuning During Normal Power Transmission

Simultaneous with the transmission of the power beam, coherent signals at three different frequencies are transmitted from the Spacetenna. Two of these signals are transmitted from the SRT, and one is transmitted from the power module being phase tuned, as shown in Figure 2. The two signals transmitted from the SRT are respectively called s_1 and s_{r1} , and the signal transmitted by the power module being phase tuned is called s_2 . The frequency of s_1 is midway between that of s_{r1} and s_2 so that the beat frequency of s_1 and s_2 is the same as that of s_1 and s_{r1} .

At the PMA, simple mixing and filtering circuitry detects two difference frequency signals. One signal is due to s_1 and s_2 . The other, which is called a phase reference signal, is that due to s_1 and s_{r1} . These two beat frequency signals are then phase compared to obtain the phase difference between them.

The phase difference between the two beat frequency signals is a function of the z-axis deformation* of the Spacetenna at the location of the power module being phase tuned plus biases in the phase feed network of the SPS. Certain components of the phase difference change with a change in frequency, others do not. Since the power module being phase tuned is transmitting at a frequency different from the power beam frequency, it is necessary to distinguish between these frequency dependent and frequency independent components in order to determine the phase correction that will be correct at the power beam frequency. This is done by shifting s_{r1} and s_2 to a different set of frequencies, according to a phase ambiguity error avoidance criterion, and making a second phase difference measurement. These two phase difference measurements are numerically adjusted by -2π , 0 , or $+2\pi$ according to a second phase ambiguity error avoidance criterion. These two numerically adjusted phase differences provide sufficient information to calculate the phase error correction² transmitted back to the SPS power module being phase tuned. This phase error correction can be made with an 8-bit binary word sent to the SPS via a data channel. An 8-bit accuracy produces a phase resolution of $360^\circ \div 2^8 \approx 1.4^\circ$. This is sufficient to give a power beam pointing resolution better than 140 meters at the Rectenna.

A tradeoff exists between satellite bandwidth requirements and the power module updating rate which is limited by filter settling times. It is anticipated that the frequency separation between s_1 and s_2 , s_{r1} and the power beam will be on the order of 1 MHz. At these frequency separations, the update interval for an entire Spacetenna can be on the order of a few seconds. It is possible that this will be fast enough to correct for any changes that will occur at the Spacetenna due to deformations, thermal effects, etc.

Phase Tuning During Startup

It is also possible to use this interferometer technique to phase tune the power modules at the power beam frequency during initial startup or maintenance. This would be necessary to calibrate the phase tuning system used during normal power transmission for any phase vs. frequency nonlinearities. In this case, the measured phase difference is the phase error correction.

*deformation in a direction toward or away from the Rectenna.

IONOSPHERIC EFFECTS

With the ground based closed loop interferometer phase control approach, ionospheric effects are limited to phase errors introduced into the space-to-earth transmission path only.

Although, the PMA is shown to be at the center of the Rectenna, it is not necessary that it be located there or even within the Rectenna site. Off-site measurement has the advantage that the signals being phase tuned do not have to pass through an ionosphere that may be subjected to undetermined heating effects by the power beam.

An important advantage of Interferometric Phase Control is its inherent ability to make use of statistical error reduction techniques to minimize any ionospheric effects. This includes time averaging and/or spatial averaging using several on and off-site phase measurement antennas.

PREDICTION OF DEFORMATION DYNAMICS/MAPPING

It should be pointed out that once the Spacetenna has been initially phase tuned, learning curves or adaptive modeling techniques could be used to predict the dynamics of Spacetenna structural deformations. With such predictions, it is felt that the capability would then exist to phase tune the entire Spacetenna based on frequency measurements of only a "few" key power modules and occasional measurements of the rest. By adding two additional receiving antennas on the earth so that there are three earth antennas spaced a few kilometers apart and not in a straight line, additional phase measurements can be made. These measurements provide information to "map" the face of the Spacetenna, that is, to determine the relative distance, direction and motion of each power module with respect to the SRT. This provides the capability for performing a transverse modal analysis from the earth, of select samples of power modules on the face of the Spacetenna. In addition, the interferometer phase control technique provides the ability to automatically identify defective power modules.

REFERENCES

1. J. H. Ott and J. S. Rice: "Digital SPS Phase Control Using Traveling Wave Interferometry" Novar Electronics Corporation Technical Report, October, 1978.
2. Ibid., p. 32.

A POWER SATELLITE SONIC SIMULATOR
James H. Ott and James S. Rice
Novar Electronics Corporation, Barberton, Ohio

ABSTRACT

A simulator is described which generates and transmits a beam of audible sound energy mathematically similar to the SPS power beam. The simulator provides a laboratory means for analysis of ground based closed loop SPS phase control and of ionospheric effects on the SPS microwave power beam.

INTRODUCTION

Novar Electronics Corporation has built and is currently testing a Satellite Power System Microwave Transmission Simulator. In a ground based laboratory environment, the simulator generates and transmits a beam of audible sound energy which is mathematically similar to the microwave beam which would transmit energy to earth from a Solar Power Satellite.

SIMULATOR DESCRIPTION

Figure 1 shows the major functional parts of the simulator. The Sonic Spacetenna (Figure 2) is 1.3 meters in diameter and contains 3200 independent transmitting elements. These elements are connected in a 64 row by 64 column matrix. Each column is driven by a driver which multiplexes each of the 64 rows 32,000 times per second. This enables the simulator's computer to control the amplitude, phase, and frequency of each of the 3200 transducers. The simulator is designed to transmit a coherent sonic power beam at 12 kHz. Any illumination taper, e.g., Gaussian, can be programmed and the resultant ground pattern studied. A computer, RAM Memory, 300 MB disc drive, and line printer are incorporated to provide a very high degree of experimental flexibility.

SIMULATOR CAPABILITIES

A unique feature of Novar's Sonic Simulator is its ability to provide actual photographs of the transmitted power beam. Figure 3 shows a scanning system which provides an intensity modulated raster of the sonic beam. By adding a phase signal to the intensity modulator, the phase coherence can also be photographed. This technique, developed at Bell Labs in the early 1950's¹, will provide photographic records similar to Figure 4.

The Sonic Simulator is currently being used to generate collimated coherent sonic beams to verify that the beam divergence and sidelobe characteristics are in satisfactory agreement with the aperture illumination equations which have been used to define the SPS microwave beam.

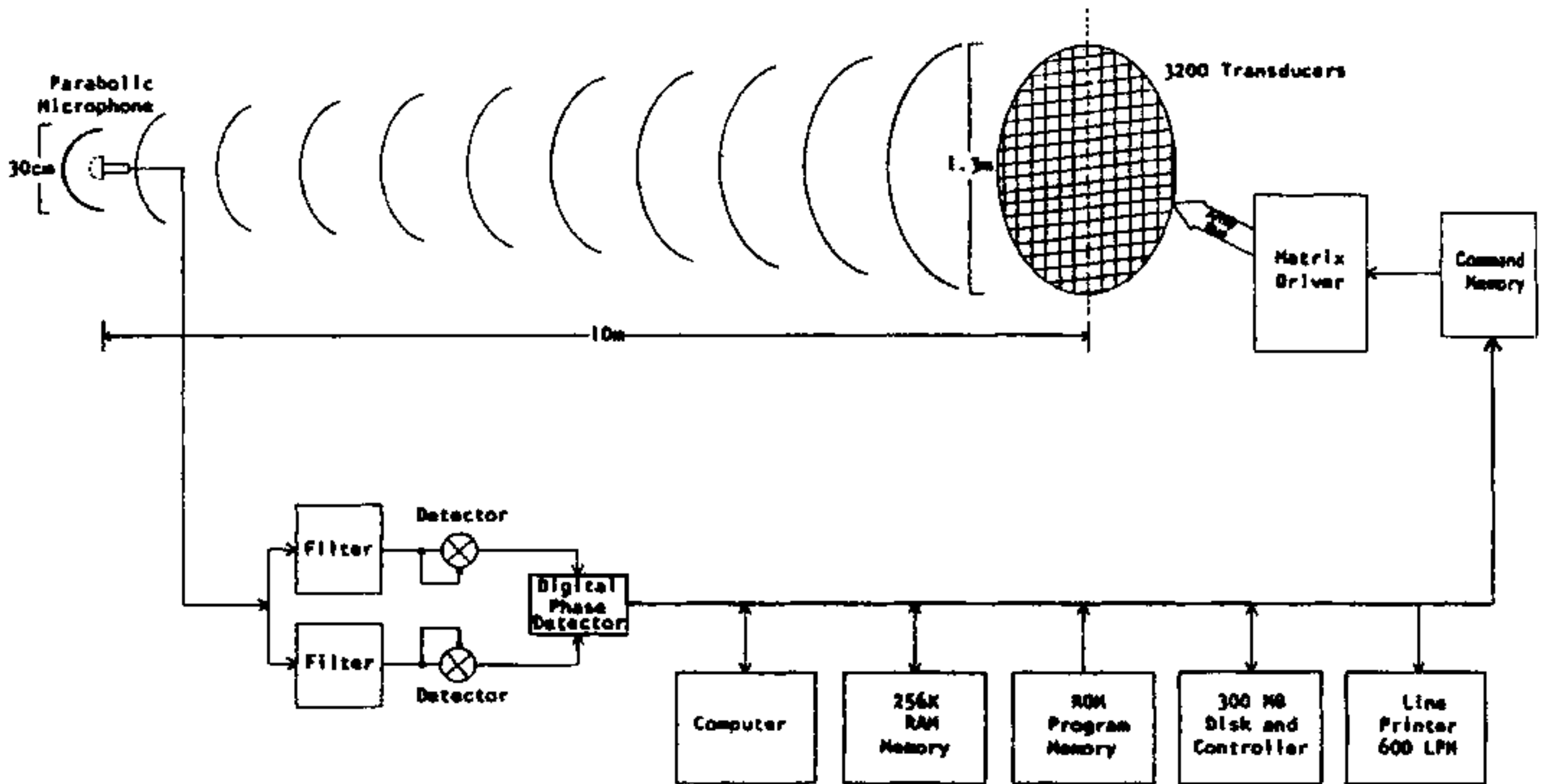

FIGURE 1
SONIC SPS PHASE CONTROL SIMULATOR
MAJOR FUNCTIONAL BLOCKS

The concept of "ground based" phase control implies a closed loop phase control system which makes corrections in deviations in SPS beam pointing and focusing from ground based measurements of the received power beam. In other words, ground based phase control is a servo control system which like any servo system has a measurable transfer function, frequency response, step response, noise factor, resolution, loop stability, etc. Novar is using its interferometer phase control technique to focus and point the sound beam². The open and closed loop characteristics of the Sonic Simulator will be measured. A descriptive servo loop diagram and transfer function will be developed and all measured characteristics will be tested for agreement with control system theory. The next step will then be to analyze and mitigate the effects of unwanted interfering inputs such as air currents in the laboratory and the reflection of the sonic beam off walls.

The Sonic Simulator can be readily forced to deal with the same noise characteristics as the ionosphere would introduce into the real world SPS phase control system. This would be accomplished by altering the propagation of the simulator's sonic beam through the use of sculptured reflecting surfaces and controlled air turbulence.

Ionospheric effects will impact an SPS Phase Control System similar to the way that noise and offset error impact any closed loop servo system. Therefore, conventional control system synthesis techniques should be able to reduce SPS phase control errors due to ionospheric effects.

Analytical techniques will be developed to permit the validation of these sonic propagation models against measured ionospheric parameters. This would, for example, lead to the quantitative correlation of ionospheric electron density patterns with the sound reflecting surface's roughness and placement.

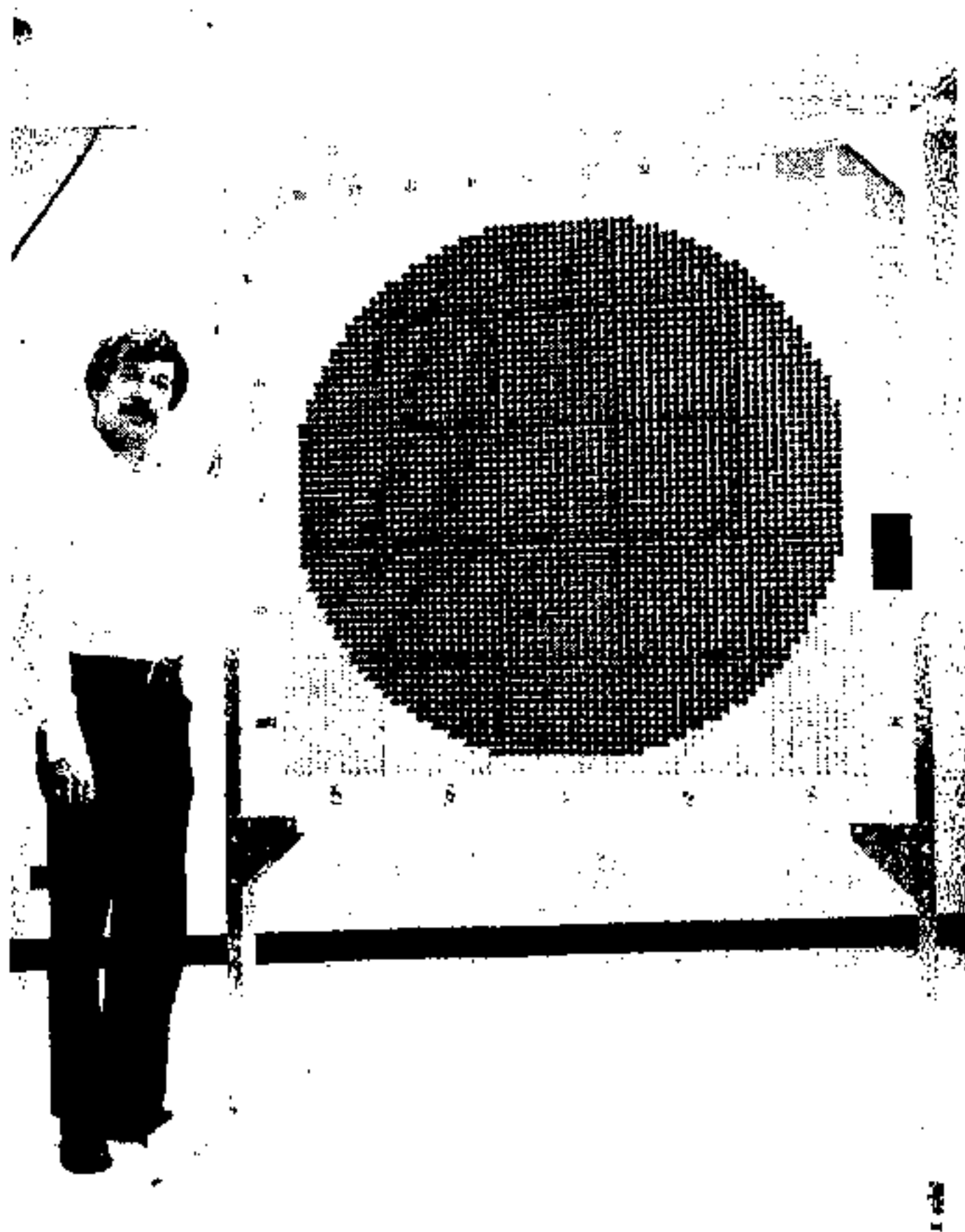

FIGURE 2
SONIC SPACETENNA

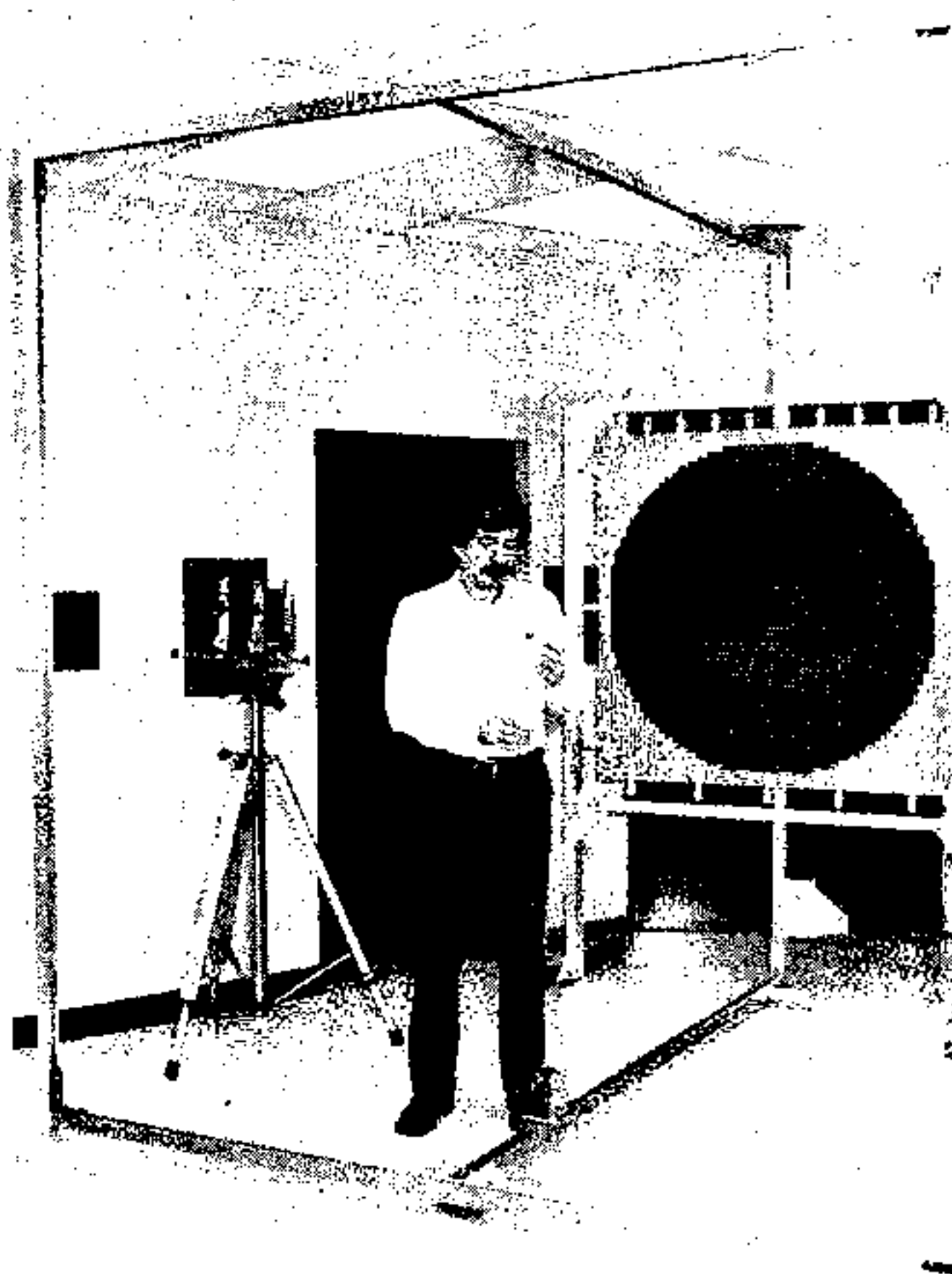

FIGURE 3
PHOTOGRAPHIC SCANNING SYSTEM

A precision mechanical scanning system provides an actual photograph of the sonic beam. The camera lens remains open in a darkened room while the sound-to-light modulator (device being pointed at) provides a light output proportional to the intensity of the sonic beam. The modulator is scanned up and down and forward and backward to provide a photograph of a cross section of the beam.

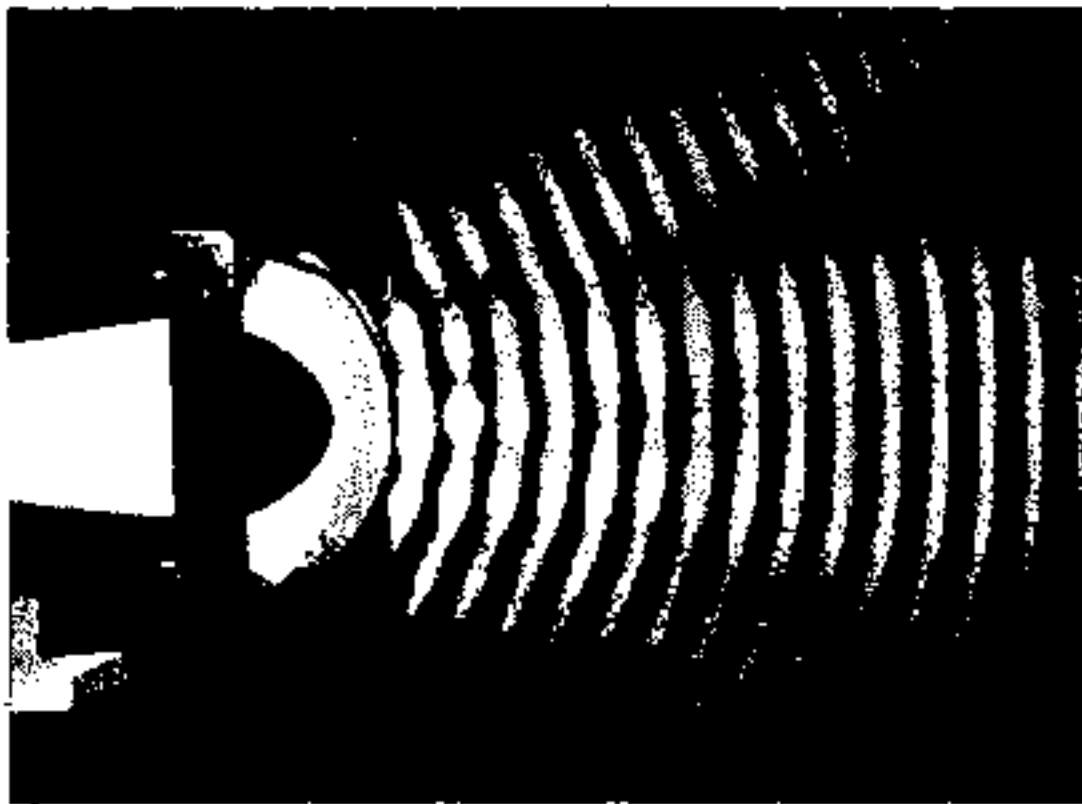
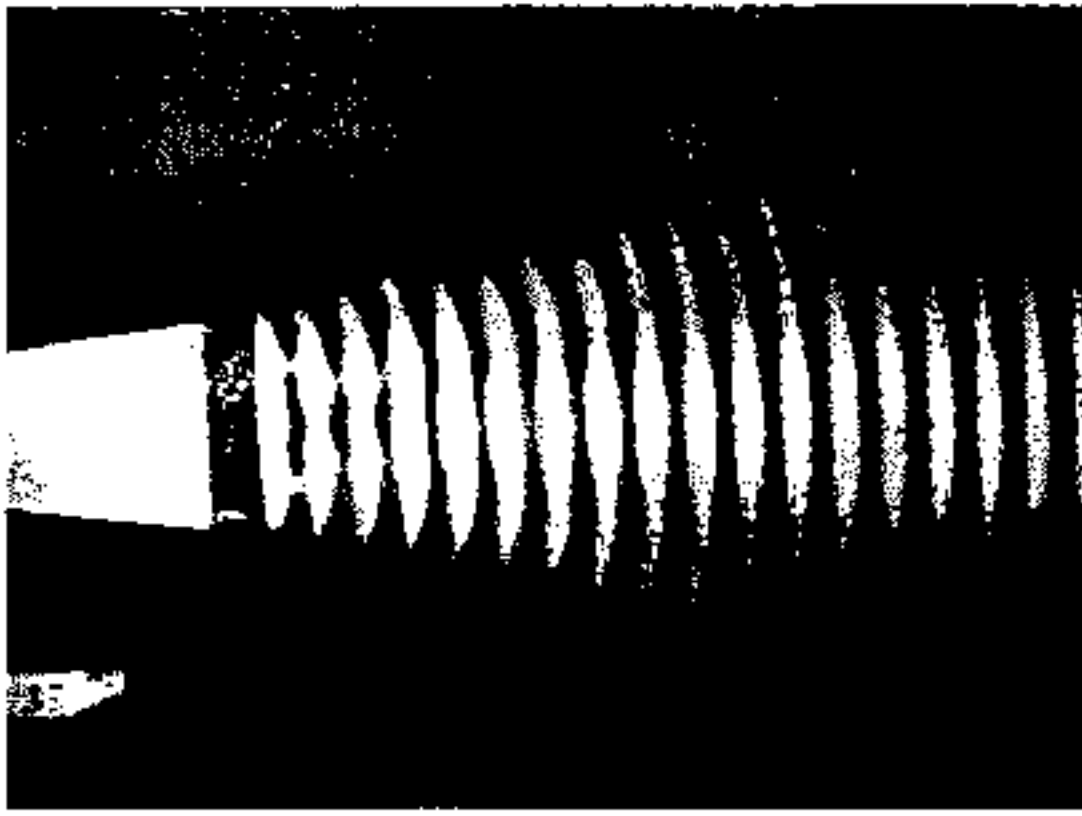

FIGURE 4
REPRESENTATIVE PHOTOGRAPH OF A
MECHANICALLY SCANNED SONIC BEAM
(Bell System Technical Journal,
1951.)

CONCLUSIONS

It is expected that a number of conclusions can be provided regarding the applicability of the sonic simulation technique to the future development of the SPS power transmission system. If conclusions are favorable, we would expect that the sonic simulator will provide a low cost alternative to many of the time consuming orbiting satellite experiments that would otherwise be necessary.

REFERENCES

1. W. E. Kock and F. K. Harvey, "A Photographic Method for Displaying Sound Waves and Microwave Space Patterns," Bell System Technical Journal, Vol. 30, July 1951, pp. 564-587.
2. J. H. Ott and J. S. Rice: "Digital SPS Phase Control Using Traveling Wave Interferometry" Novar Electronics Corporation Technical Report, October, 1978.

SMALLER SPS SYSTEM SIZING TRADEOFFS
G. D. Arndt and L. Monford
NASA-Johnson Space Center Houston, TX

Introduction- The present solar power satellite (SPS) system was optimized to provide 5 GW of electrical power at the ground using a 1 Km diameter antenna and a 10 Km diameter rectenna. This antenna sizing and maximum power transmission were determined by two constraints; a 23 KW/m² thermal limitation in the transmit antenna and a 23 mW/cm² maximum RF power intensity in the ionosphere. This paper considers technical and economic tradeoffs of smaller optimized SPS systems configured with larger antennas, reduced output powers, and smaller rectennas. The advantages of smaller systems are two-fold: (1) commercial utility companies prefer to integrate lower power levels into their grids, and (2) smaller rectenna sizes than the 10 Km diameter reference configuration may be preferred from a land utilization and site location viewpoint.

The differential costs in electricity for seven antenna/rectenna configurations operating at 2.45 GHz and five satellite systems operating at 5.8 GHz have been determined and are described in detail in a report to be published. Because of space limitations only the results are summarized in this paper.

Microwave Systems and Cost Considerations

The thermal limitation at the center of the transmit antenna is due to the heat radiated by the DC-to-RF power converters, i.e., klystrons. The present configuration has 72 KW klystron tubes operating at 85% conversion efficiency and cooled by passive heat - pipe radiators. This thermal limitation is a severe constraint on higher frequency (5.8 GHz) systems which have lower efficiency klystrons (80%) and smaller antenna areas. An improved thermal design using graphite composite materials with high emissivity coatings which provide a 33% increase in heat rejection is proposed in the report and used in these calculations.

The ionospheric power density limitation, a critical parameter in the 2.45 GHz systems, is to prevent possible nonlinear interactions between the ionosphere and the power beam. These nonlinear heating effects are of concern because of possible disruptions in low frequency communications and navigation systems produced by radio frequency interference (RFI) and multipath effects. Theoretical studies of the ionosphere completed in the early phases of the SPS evaluation program indicated the power density should be limited to 23 milliwatts per square centimeter or less in order to prevent nonlinear heating effects. This theoretical value, 23 mW/cm², was taken as the SPS design guideline. Subsequent ionospheric heating tests conducted at Plattville, Colorado, and Arecibo, P. R. during the past year (the results of which are reported elsewhere at this conference) have indicated this 23 mW/cm² threshold may be too low.

The 2.45 GHz downlink power beam frequency is in the center of a 100 MHz IMS (Industrial, Medical and Scientific) band which allows users to interfere with other users in that frequency region. This 2400-2500 MHz band is not particularly affected by weather conditions and an SPS system should not suffer weather outages. Another IMS band (5800 + 75 MHz) is also available for possible SPS usage. However an SPS system operating in this frequency region may have to be shut down under very poor weather conditions.

The microwave systems were resized with higher gain antennas and considering various ionospheric and thermal power density limitations. A 10 dB gaussian antenna illumination provides maximum rectenna collection efficiency while minimizing sidelobe levels. Other illumination tapers were investigated but the 10 dB gaussian was the most efficient as was true for the reference SPS system.

The groundrules for sizing the new microwave systems included using the present SPS antenna error parameters, i.e., 10^0 phase error, +1% amplitude error, 2% tube failures, +1 min antenna tilt, +3 min subarray tilt, .25" mechanical spacing between subarrays, etc., and the rectenna was sized to receive 88% of the transmit power. The relative antenna/rectenna sizes for 2.45 GHz and 5.8 GHz operation are shown in Figure 1.

A detailed analysis of subsystem costs and masses for the reference 5 GW solar power satellite with silicon solar cells is given in the Boeing Aerospace Final Report D180-25461-2, November 1979. These values are used as a baseline for computing costs for the different antenna/rectenna configurations. Since the purpose of this study is to determine the relative or differential costs for the various configurations, any future changes in the absolute costs for the reference system should not have a great impact upon the conclusions herein stated.

The principal elements in the SPS recurring costs are satellite hardware, transportation, space construction and support, rectenna, program management and integration, and cost allowance for mass growth. These cost calculations also included the following guidelines: 30 year operating lifetime, plant factors of .92 and .90 for 2.45 GHz and 5.8 GHz operation respectively, 15% rate of return on investment capital, 22% mass growth factor to cover potential risks in solar array and microwave system performance estimates, 17% of net SPS hardware cost factor to account for mass growth, and 10 GW per year power installation. The cost and mass for each of twelve satellite subsystems were varied according to total power, antenna size, frequency, efficiency, etc, of the candidate antenna/rectenna systems. The electricity costs in mills per KWH and the differential cost increases for 2.45 GHz and 5.8 GHz systems are summarized in Figures 2 and 3, respectively. The data indicates costs for the 2.45 GHz systems are heavily dependent upon ionospheric power density limitations. The 2.45 GHz and 5.8 GHz alternate configurations can provide smaller rectenna sizes at the expense of added electricity costs.

Summary

The satellite and associated microwave system have been reoptimized with larger antennas (at 2.45 GHz), reduced output powers, and smaller rectennas. Four constraints were considered: (1) the 23 mw/cm^2 ionospheric limit (2) a higher (54 mw/cm^2) ionospheric limit (3) the 23 KW/m^2 thermal limit in the antenna, and (4) an improved thermal design allowing 33% additional waste heat. The differential costs in electricity for seven antenna/rectenna configurations operating at 2.45 GHz and five satellite systems operating at 5.8 GHz have been calculated. The conclusions are:

- o Larger antenna/smaller rectenna configurations are economically feasible under certain conditions.
- o Transmit antenna diameters should be limited to 1-1.5 Km for 2.45 GHz operation and .75-1.0 Km for 5.8 GHz.
- o Three configurations were selected for minimum impact on electricity costs (See next page)
- o The present ionospheric limit of 23 mw/cm^2 is probably too low and should be raised after the ionospheric heating tests and studies are completed. For SPS cost considerations, it is very important to ascertain the true upper limit.
- o The 5.8 GHz configurations are constrained by antenna thermal limitations, rather than ionospheric limits. Potential utility grid impacts of 5.8 GHz

system which has to be shut down on an unscheduled basis due to localized weather conditions are not known.

o Multiple (two to four) antennas on a single solar satellite as shown in Figure 4 are definitely recommended regardless of the particular antenna/rectenna configuration chosen. This is a means for maintaining the same amount of power supplied to the ground while reducing the geosynchronous slots (spacings) required for the satellites.

	23 mW/cm ² Ionospheric Limit	2.45 GHz 54 mW/cm ² Ionospheric Limit	5.8 GHz Improved (33%) Thermal Limit
Antenna Diameter	1.36 Km	1.53 Km	.75 Km
Rectenna DC grid power	2.76 GW	5.05 GW	2.72 GW
Rectenna Diameter	7.6 Km	6.8 Km	5.8 Km
Relative Rectenna Area	56%	46%	33%
Electricity Cost Increase	50.2%	17%	36%
Electricity Cost (mills/KWH)	70.6	55	64

Note: The rectenna areas and electricity costs are in comparison to those for the reference SPS system.

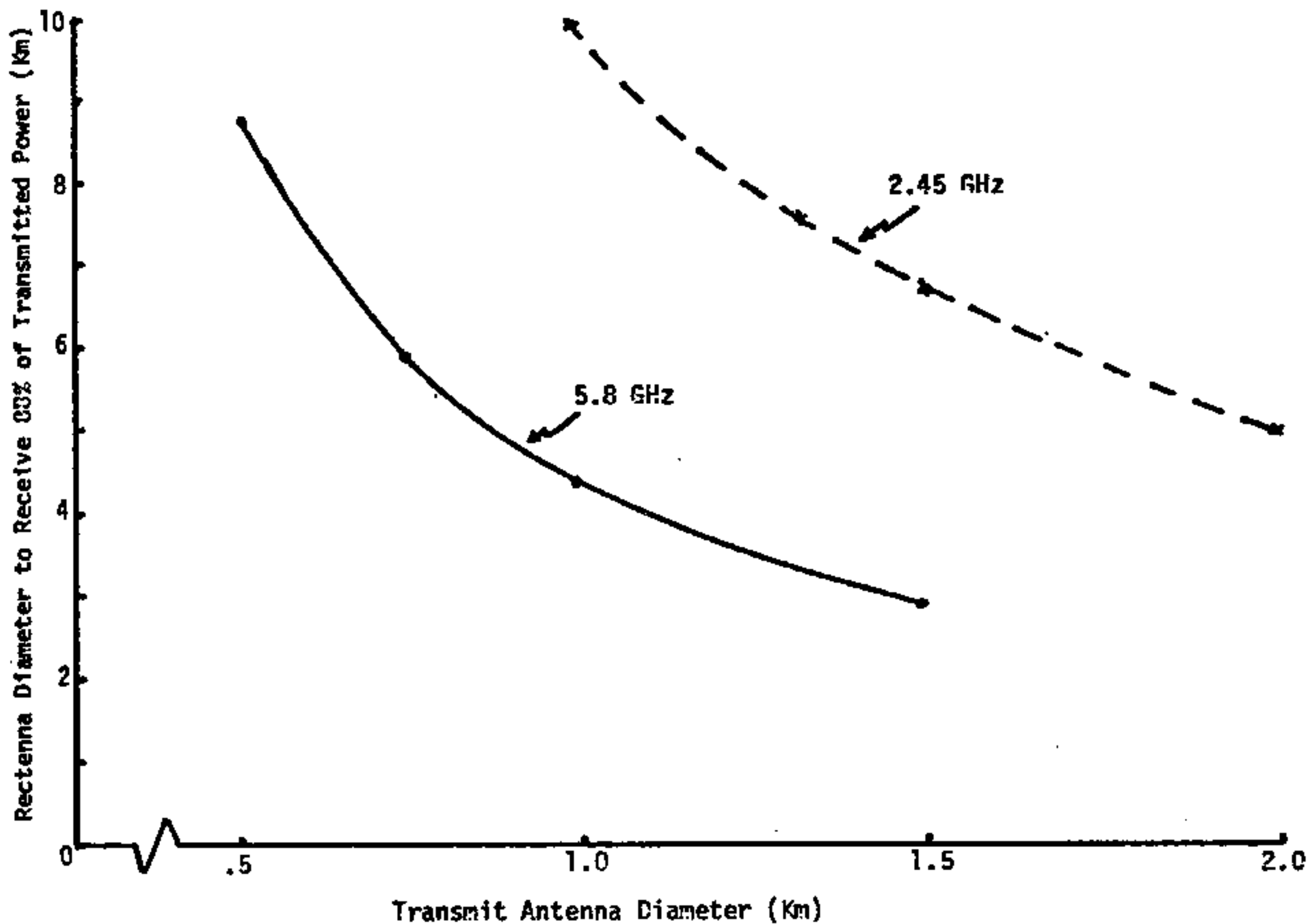

Figure 1. Antenna/Rectenna Sizing Summary

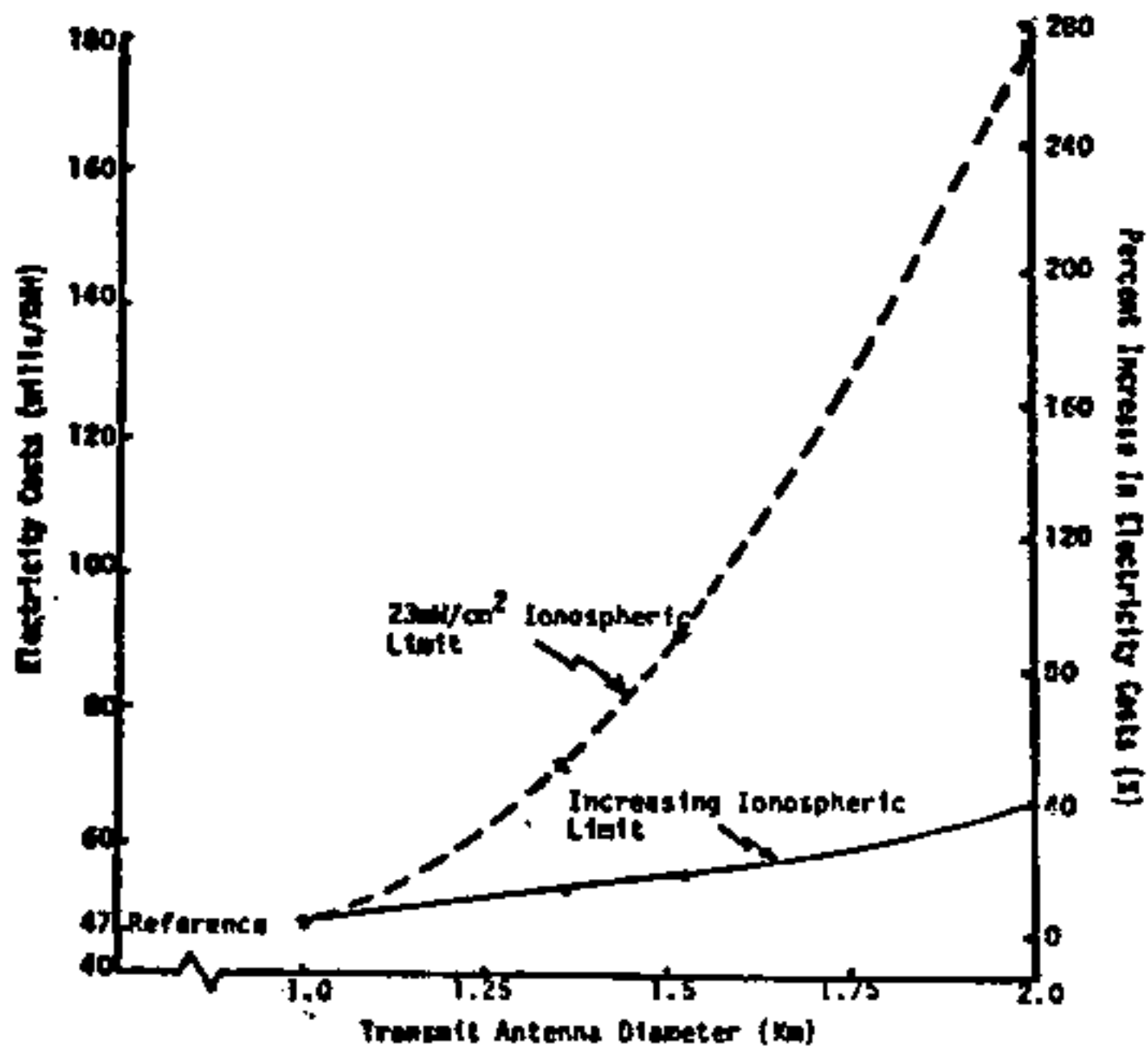

Figure 2. Electricity Costs for 2.45 GHz Systems

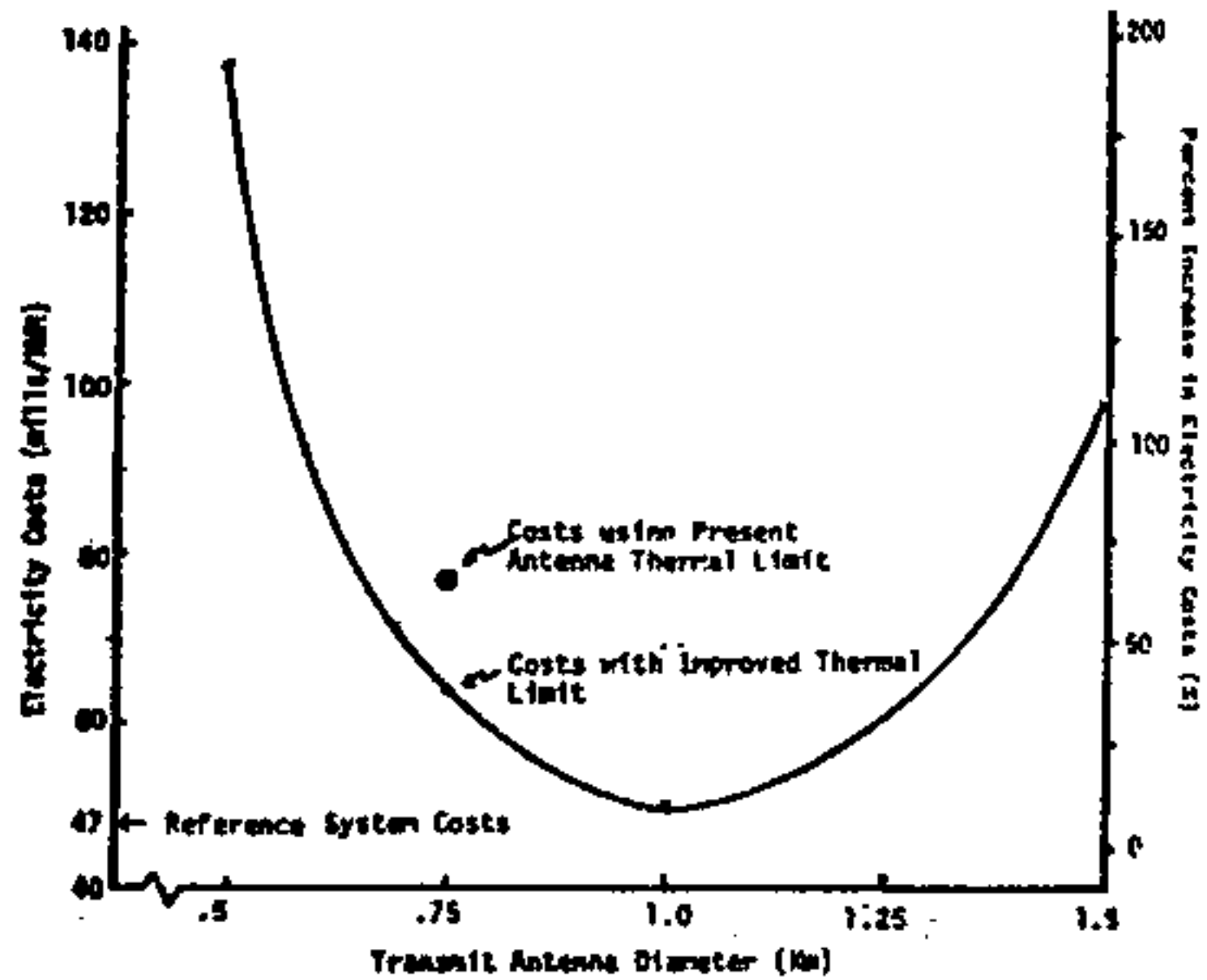

Figure 3. Electricity Costs for 6.8 GHz Systems

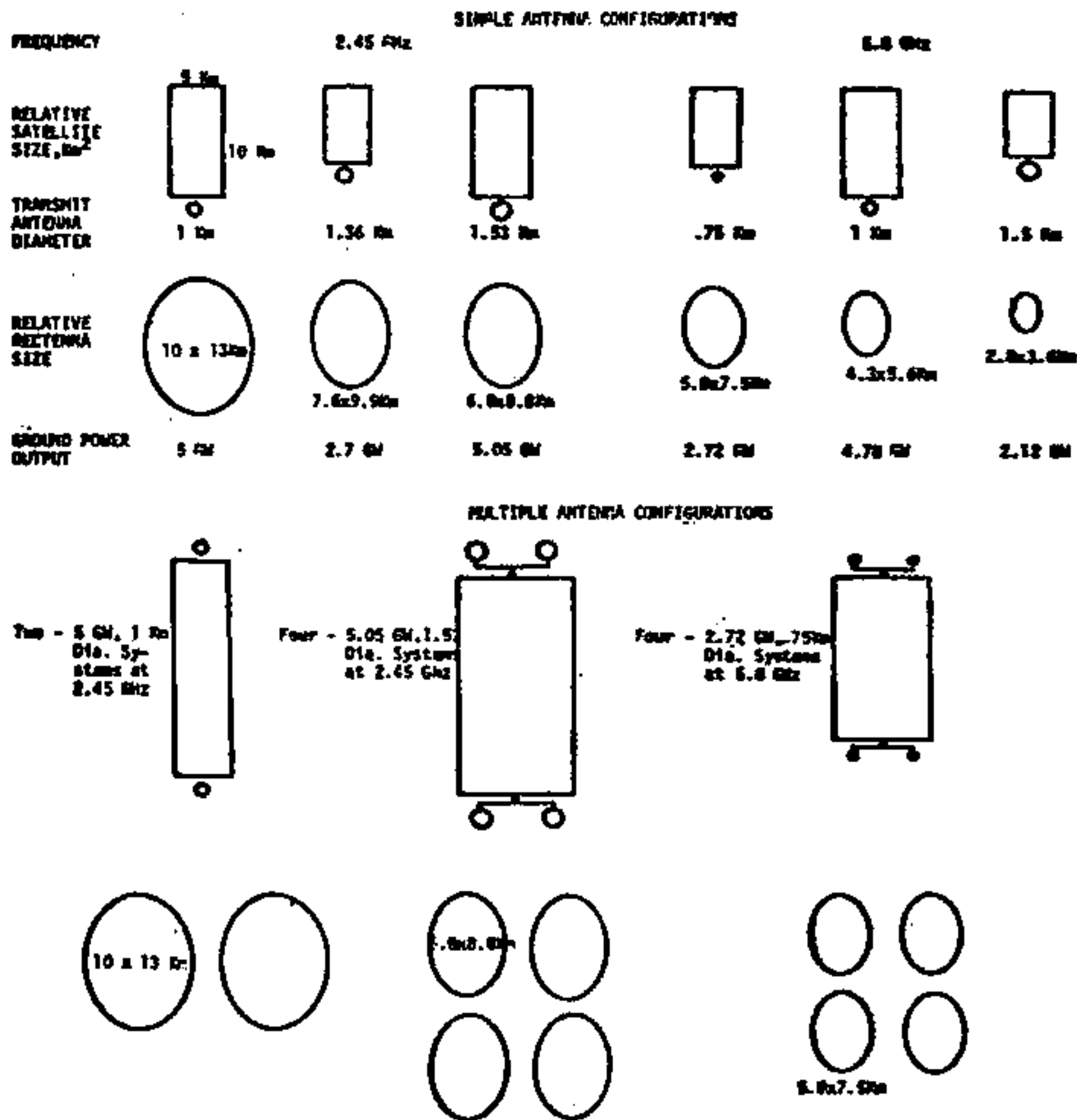

Figure 4. Relative Antenna/Rectenna Sizes Configurations

SPS CONSTRUCTION PERSPECTIVE/SUMMARY

H. E. Benson
NASA/JSC - Houston, Texas

Studies have been conducted on the construction of Solar Power Satellites and the following paragraphs discuss the perspective which can be drawn from the studies.

The SPS size requires space construction. A 5 GW Satellite may be as large as 54 square KM. The overall density of this constructed Satellite is in the order of .0002 KG/M³. Launching an assembled Satellite of this density would be impractical for two reasons: 1. The assembled structure would not be able to withstand the launch loads, and 2. The number of launches required to launch assembled structure of this density would require an extensive number of launches thus causing the transportation cost of an SPS system to be prohibitive.

Space construction will consist of simple and repetitive, construction operations. These operations will impact the design of the Satellite. ~~As an example,~~ although studies indicate the mass of a photovoltaic and thermal-cycle Satellite configurations are similar, the construction of the two are different. The photovoltaic configuration is favored since it is a simple geometry which allows repetitive operations. The thermal-cycle system has many different operations such as fluid connections, radiators and a complex geometry.

Studies have indicated that large assembly factories located in geosynchronous orbit (GEO) could build an SPS in space in a period of six months. The power generation system (solar array and structure) and the power transmission system (microwave antenna) would be built at the same time with a crew size in the order of 400. Figure 1 depicts the antenna in red and the solar array in blue. A logistics base in low earth orbit manned with approximately 200 personnel would be required to support the assembly base in GEO.

Construction of an SPS can be accomplished in either LEO or GEO. If LEO is used it will be necessary for the construction operation to build the SPS in pieces in LEO and final assemble the pieces in GEO. This is necessary since the principal loads are aerodynamic and gravity gradient and these loads would be prohibitive on a final assembled SPS in LEO. The debris collision hazard and the earth shadow thermal cycling is also greater in LEO. For maintenance considerations, it will be necessary to provide maintenance facilities in GEO either on the Satellite or facility additions to a construction base located in GEO.

The main crew considerations are the stay time on orbit. Ninety days appears to be a reasonable duty period considering: Remote confinement, zero-G effects on the body and nominal radiation exposure. For GEO, EVA activities will be limited due to increased radiation exposure and storm cellars will be required for major solar events. The primary construction functions will be to maintain and operate equipment, and final assembly and checkout.

In conclusion, it is recognized that the ability to construct an SPS must be developed through an evolutionary process. This process would begin with Shuttle operations and when construction timelines exceed the Shuttle capability small manned bases in LEO will be used. This technology evolution would gather the experience and knowledge to build large bases in LEO and GEO to support an SPS construction capability.

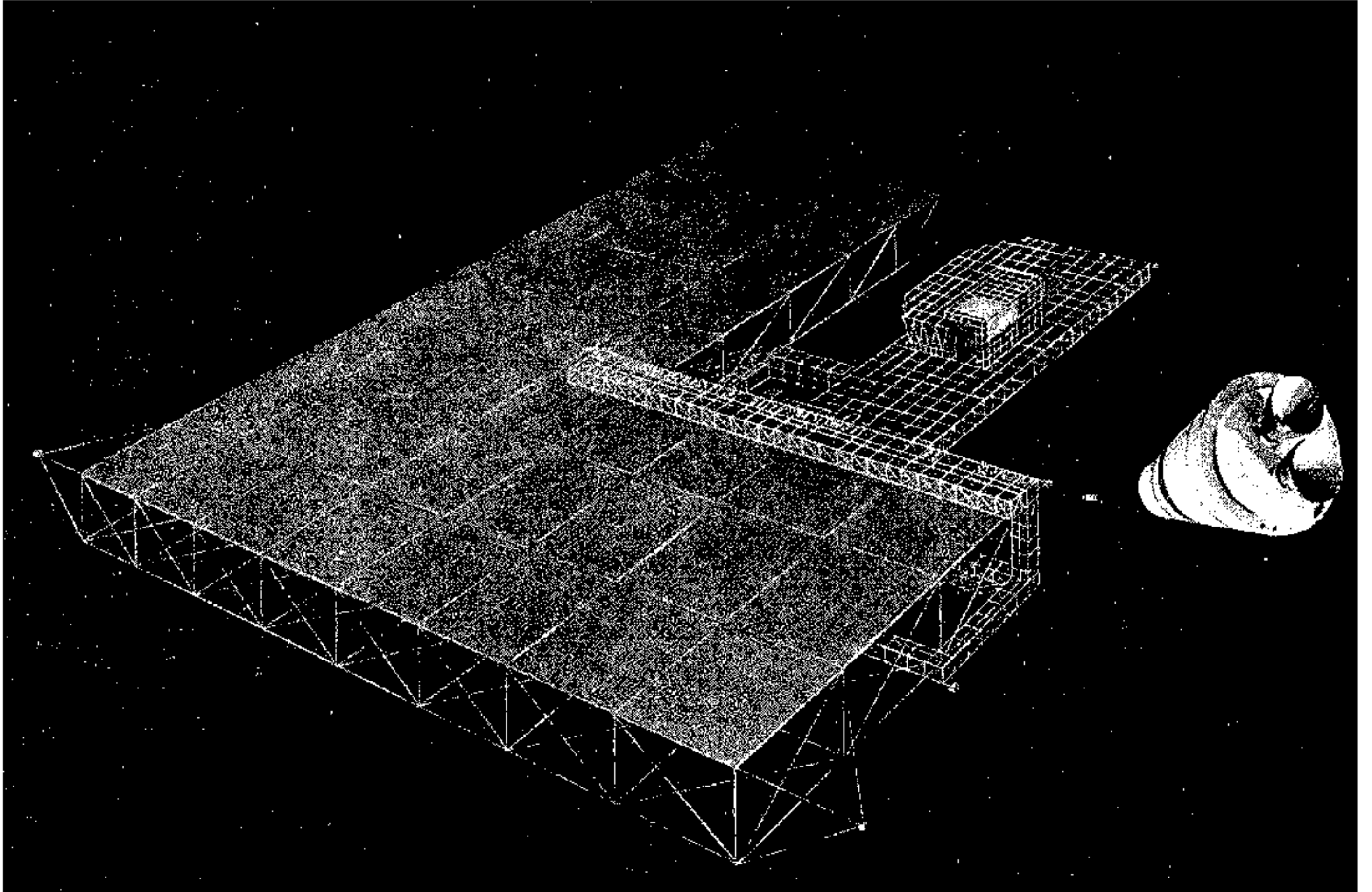

Figures 1. GEO Assembly Base

INTEGRATED SPACE OPERATIONS OVERVIEW

Gordon R. Woodcock
Boeing Aerospace Co.

Space delivery, construction and maintenance of solar power satellites will require an integrated network of space operations including several transportation systems as well as construction and operations bases. The interrelationships among the various operations set the flight rate and capacity requirements on them and hence must be taken into account in determination of the space operations costs for SPS.

Figure 1 illustrates the elements of the integrated operations. Launch vehicles deliver crews and material to low Earth orbit (LEO). Heavy lift vehicles carry cargo and propellant while personnel launch vehicles (modified Space Shuttles) carry crews to and from orbit. Their deliveries are made to a base in low Earth orbit. This base is a staging area for crews and cargo and also serves as an assembly base for the electric orbit transfer vehicles (EOTV's) that carry cargo to and from the geosynchronous orbit (GEO) base. At the LEO base cargo and propellant pallets are removed from HLLV's, stored as necessary, and transferred to EOTV's. Each EOTV can carry ten HLLV payloads; a fleet of about 25 EOTV's shuttle payloads to GEO and return empty shipping containers. A typical EOTV round trip takes 8 to 9 months.

Personnel and priority supplies are delivered to the GEO base by a personnel orbit transfer vehicle (POTV). Chemically-propelled, this type of vehicle sacrifices efficiency for speed. It can make the trip from LEO to GEO in less than a day and return in a similar time. The POTV carries 80 passengers and a few tons of cargo. The passenger accommodations are similar in appearance to those of a jet airliner as shown in Figure 2. Figure 3 shows the POTV passenger module joined to its propulsion stage.

Operating satellites will require periodic maintenance. The reference scenario calls for a visit to each SPS every six months to remove and replace defective hardware and replenish consumables. The GEO base serves as a headquarters and staging area for maintenance operations as well as for construction of satellites. The maintenance sortie vehicle system includes a crew habitat for 80 people, and personnel OTV's for transport of the maintenance crew and material from the GEO base to the SPS's needing maintenance. On a 90-day sortie, one vehicle can visit and service 20 SPS's. Remove, replace and replenish operations at each satellite are estimated to require 4 to 5 days, aided by semi-automated remove and replace equipment permanently installed on each satellite.

Satellites are shut down and the solar arrays turned away from the sun during maintenance in order to enhance crew safety.

Trade studies concluded that: (1) Satellite maintenance operations should be remove-and-replace rather than in-place repair to minimize SPS outage times; (2) Hardware repair at the GEO base pays off in reduced cost for spares acquisition and transportation from Earth.

Development of the integrated crew operations concept included consideration of crew safety and well-being. Stay-times in space were restricted to 90 days, based on physiological and psychological considerations. After 90 days in zero-g, a crewperson will require 90 to 180 days on Earth before returning to the zero-g environment. With the exception of crew in-transit between LEO and GEO in a POTV, all personnel are within an hour's transit to a solar flare storm shelter. The POTV is shielded with 5 g/cm^2 and can always reach safety in 5 hours or less.

Analyses of GEO base operations have estimated a construction and support crew of about 440, including all support and indirect functions. The maintenance operations crew increases year to year as the number of satellites to be maintained increases. The maintenance crew includes equipment repair personnel and their support.

The LEO base crew required is roughly 200. Most of the LEO base crew are logistics personnel; a contingent for space-based transportation vehicle maintenance is also provided. An additional increment of crew are provided periodically for construction of electric orbit transfer vehicles. Figure 4 shows the time history of LEO and GEO base crew size.

Integrated space operations are highly interrelated as diagrammed in Figure 5. These interrelationships were quantified and used to determine the frequency of operations and total acquisition requirements for all vehicles. Results (for the reference scenario) are shown in Figures 6 and 7. These results are the basis for total space transportation and construction costs, reported in another paper.

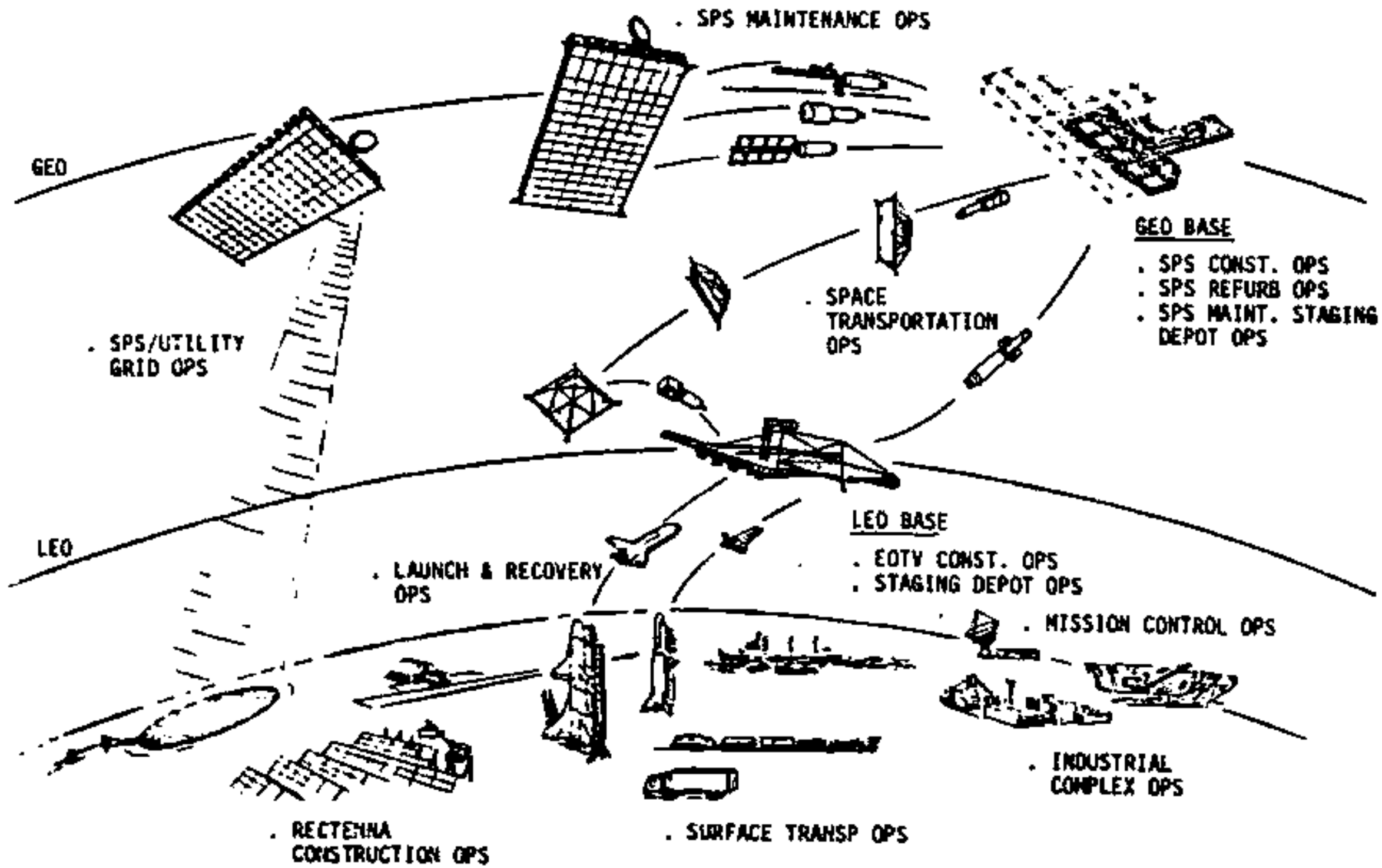

Figure 1-INTEGRATED SPS PROGRAM OPERATIONS

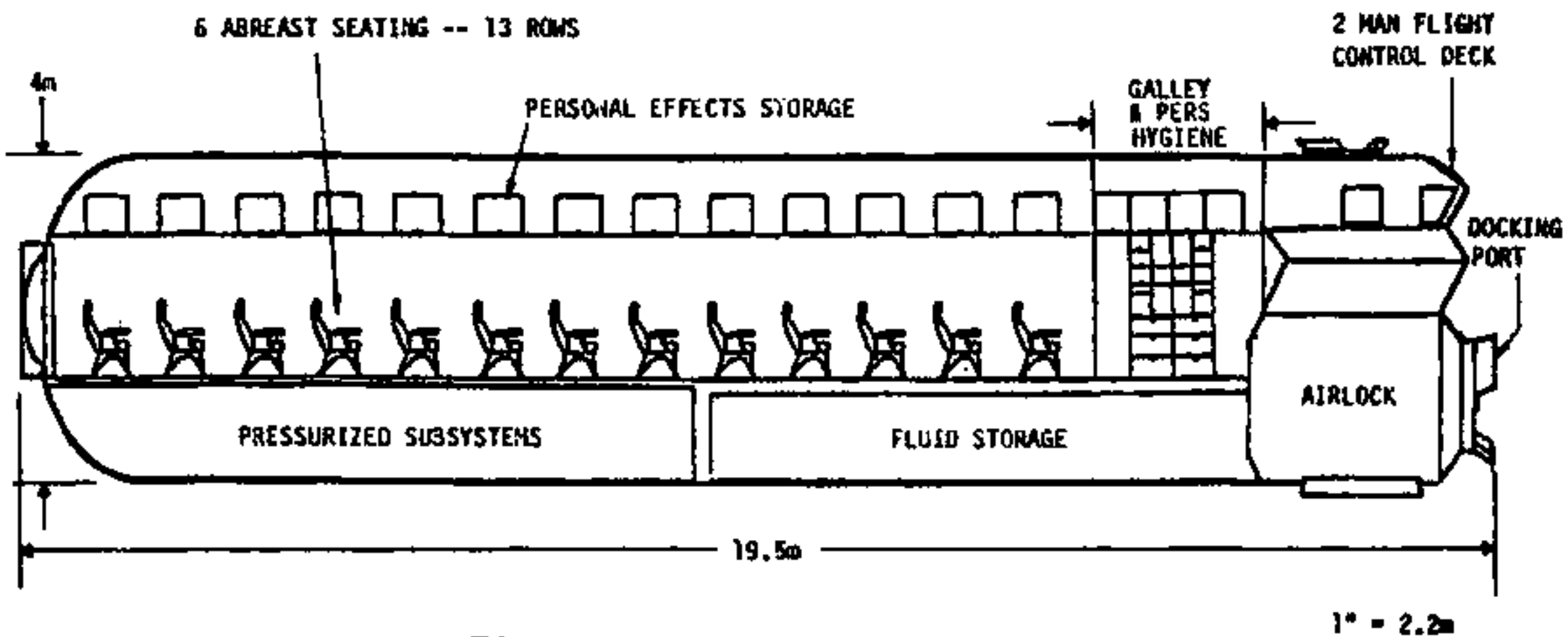
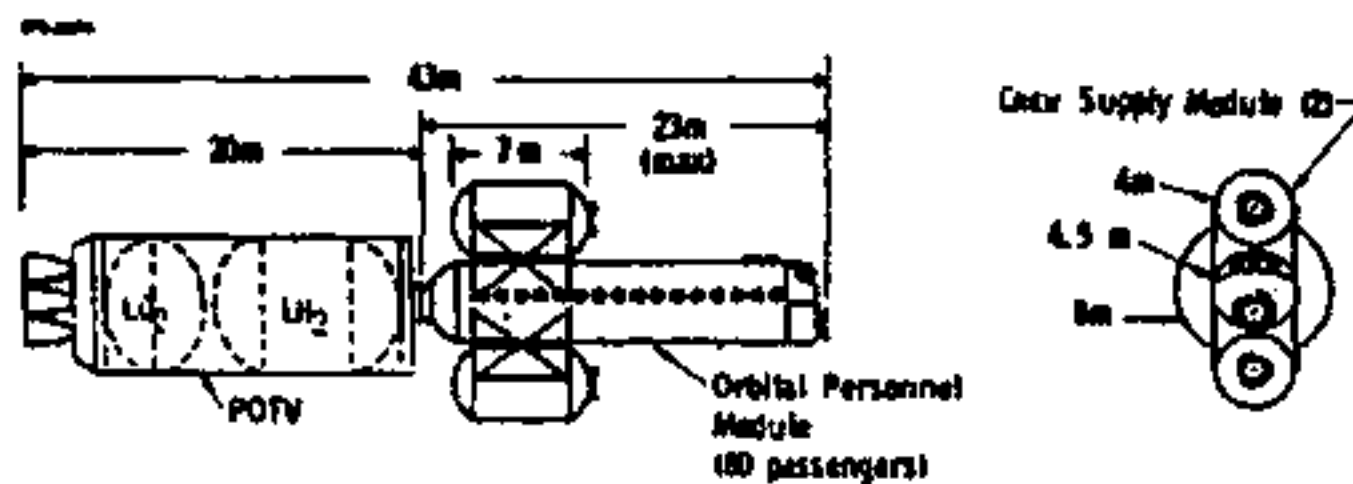

Figure 2- ORBITAL PERSONNEL MODULE



STAGE CHARACTERISTICS

- Dry - 14 MT
- Up Prop - 200 MT
- Down Prop - 185 MT
- Up Payload - 90 MT
- Down Payload - 80 MT
- Refuel at • GEO Base

PAYLOAD CHARACTERISTICS

- Passengers - 80
- Flight Crew - 6
- OPM - 98.4 MT
- Supplies - 15.7 MT (4600 Man Days)
- Supply Modules - 12.3 MT
- Priority Cargo - 3.5 MT
- Struct Frame - 1.9 MT

Figure 3- PERSONNEL ORBIT TRANSFER SYSTEM CREW ROTATION/RESUPPLY

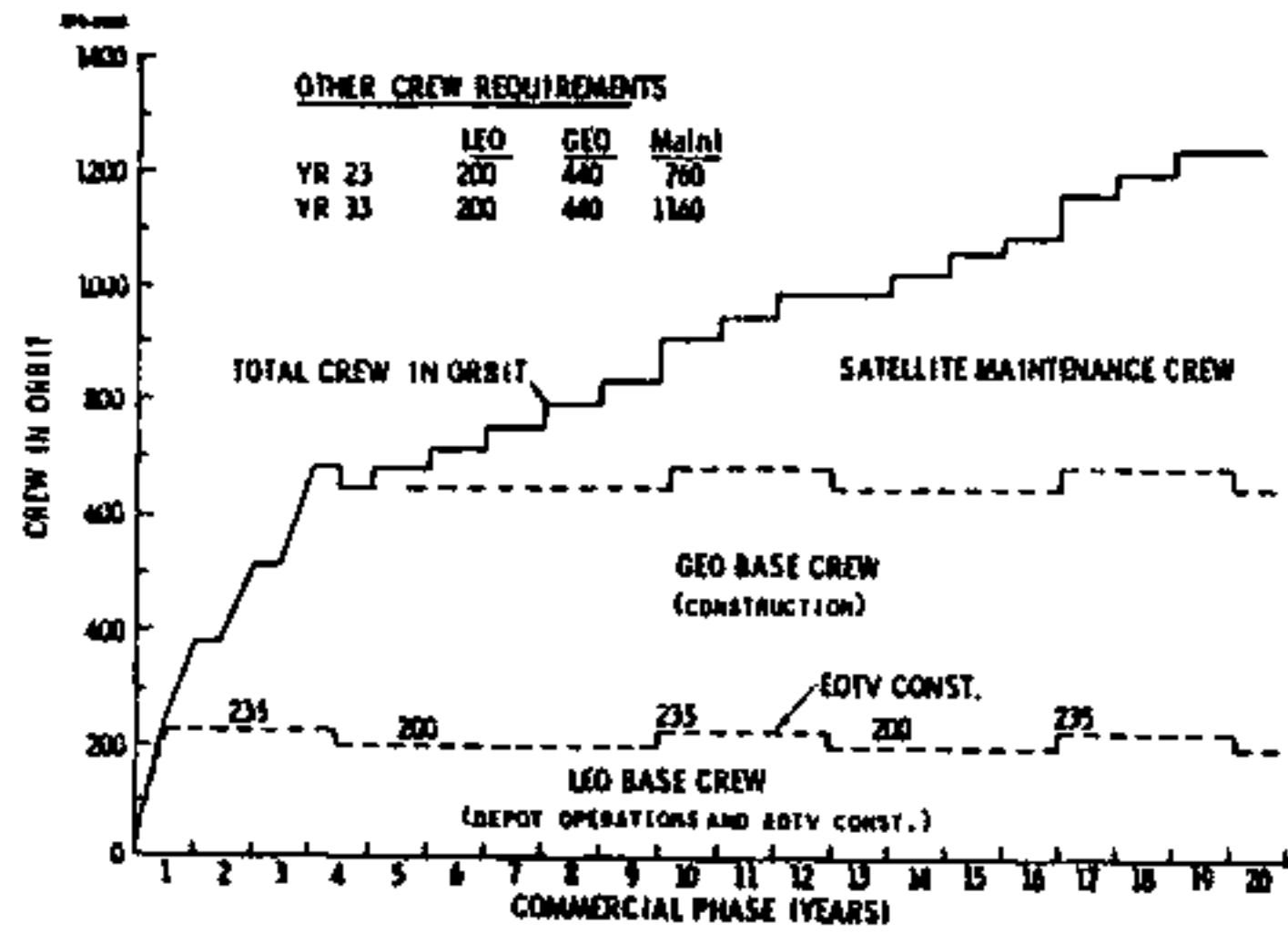

Figure 4- CREW IN ORBIT

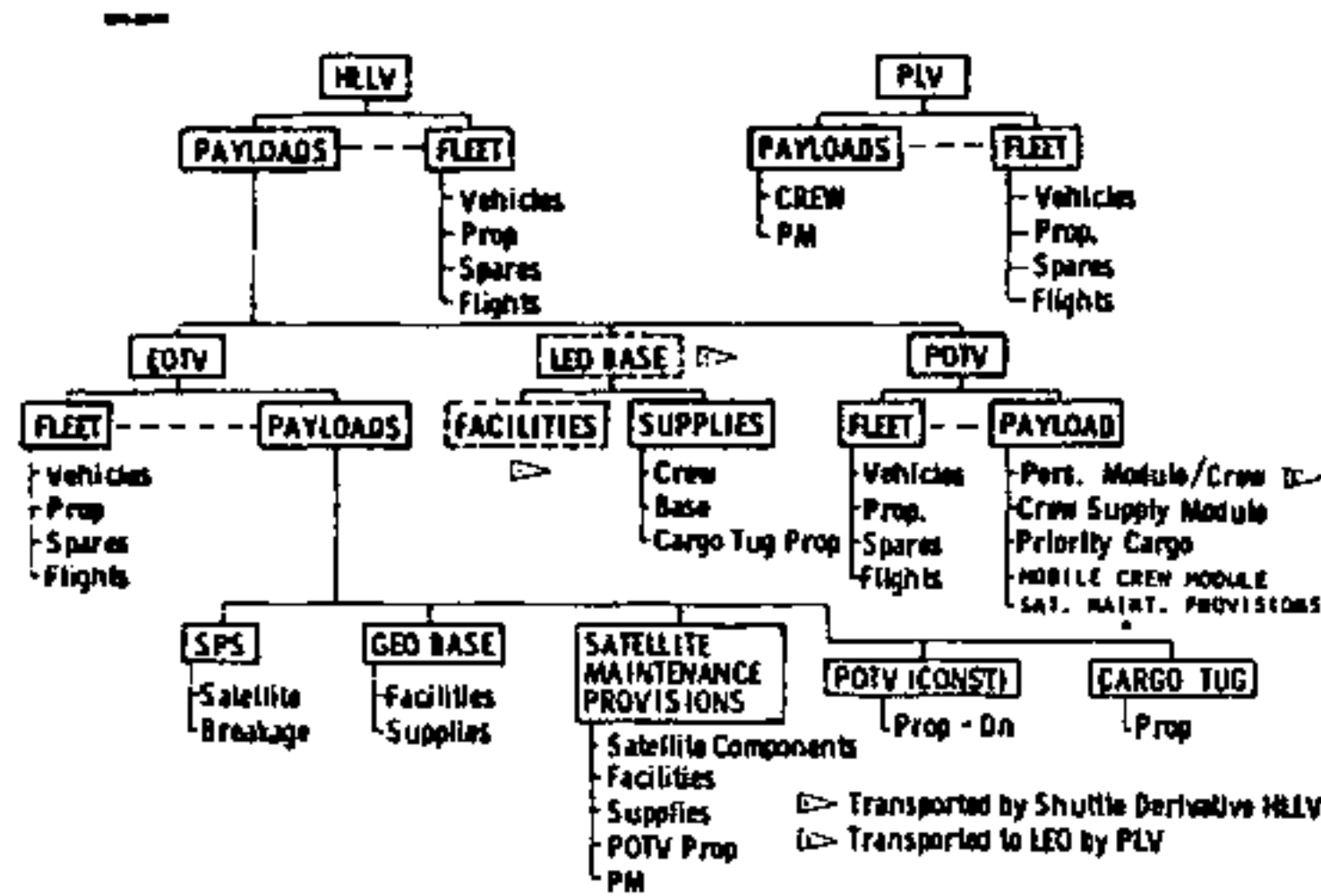

Figure 5- SPACE TRANSPORTATION TRACEABILITY

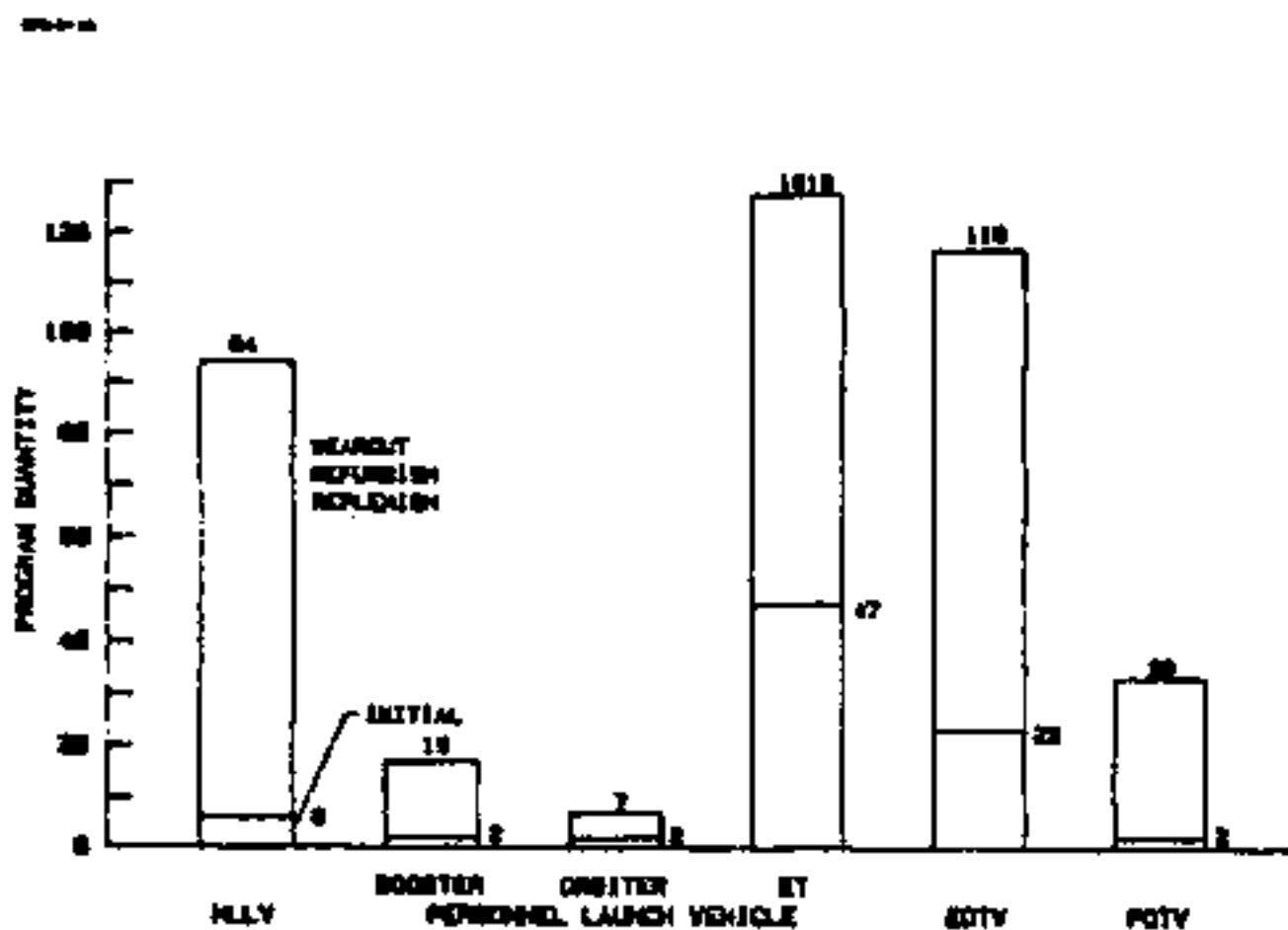

Figure 6- TRANSPORTATION VEHICLE QUANTITIES

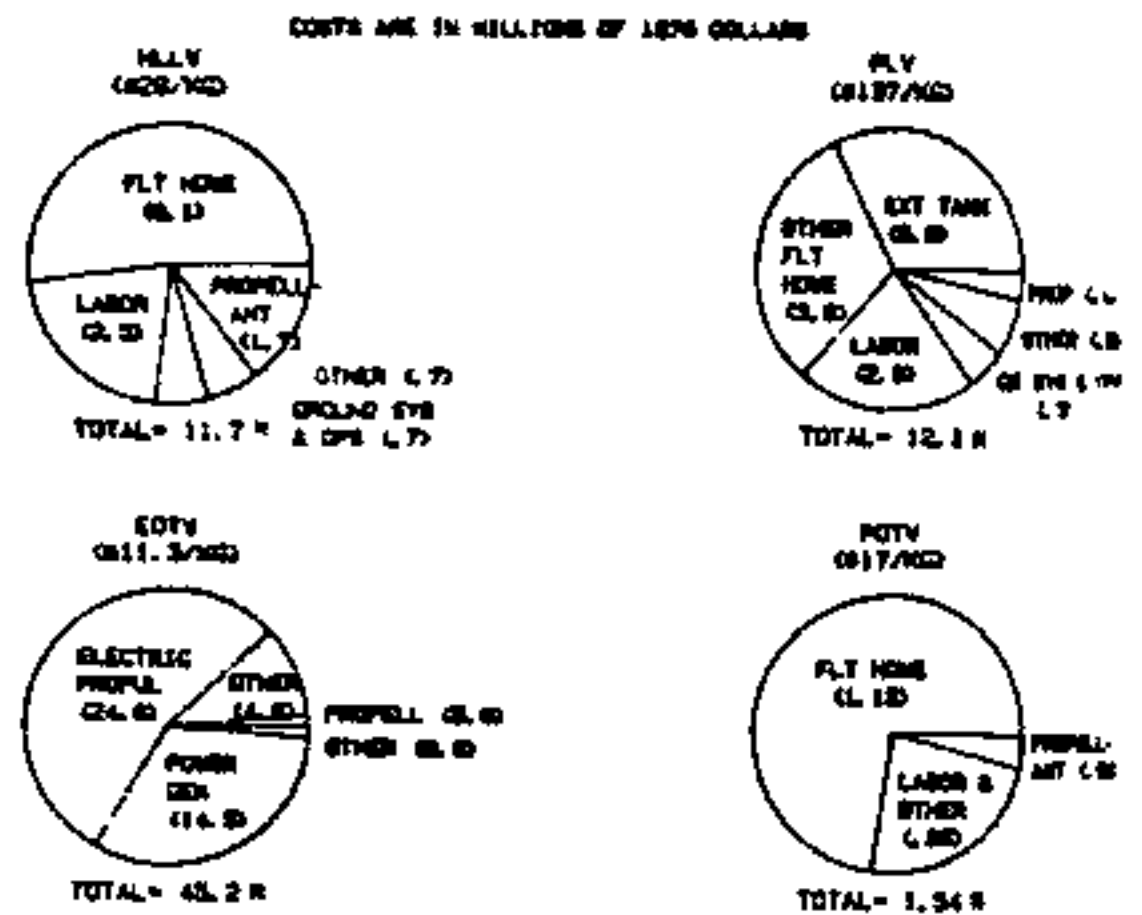

Figure 7- COST PER FLIGHT

SPECIFIC CONSTRUCTION TASKS

William V. McRae, Jr., Rockwell International
3322 South Memorial Parkway Huntsville, Alabama 35801

The issue of Satellite Power System (SPS) "technical feasibility" encompasses not only the embodiment of hardware technology within viable engineering designs, but also the development of feasible operational concepts starting with the mining of resources on earth and ending with the fully constructed satellite in orbit. The evolution of this end-to-end operations analysis begins with the conceptualization of specific construction tasks. The definition of construction tasks - at least initially - must assume processes and machines somewhat analogous to those used on earth. By so doing, one can achieve a reasonable first-order basis for estimating personnel requirements, assembly rates, and material flow demands. From these data, crew sizes, construction schedules, and space logistics traffic models are developed by further analysis. In turn, the on-earth requirements for launch site warehousing and propellant storage, logistics schedules, manufacturing/production and, ultimately, basic resources evolve. Figure 1 illustrates the logic flow of these required functional analyses for both the rectenna and the satellite.

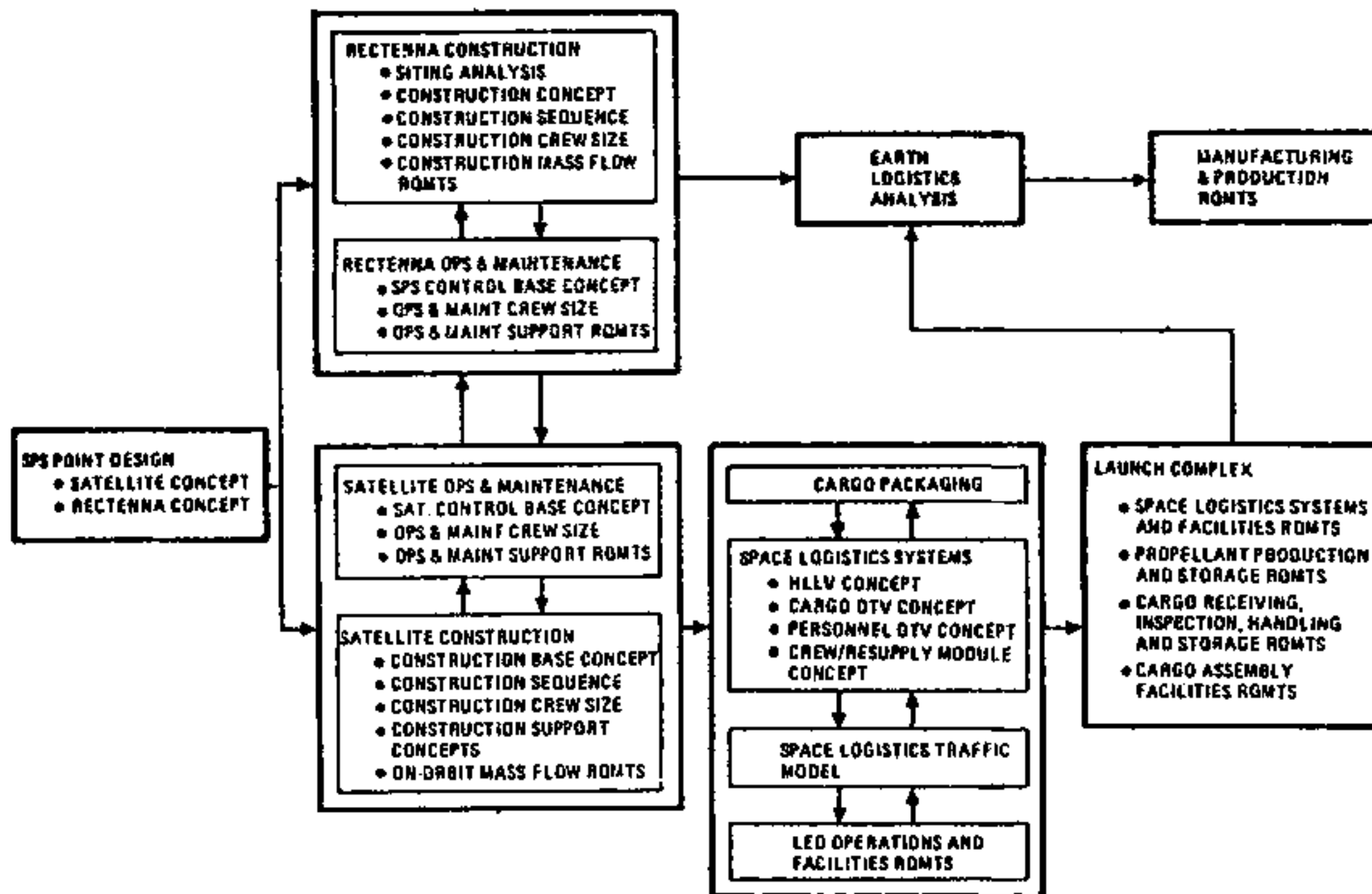

Figure 1. Major Tasks of the End-to-End Analysis

Numerous feedbacks and iterations are required in the analyses of construction tasks. In the case of the satellite, common sense dictates that the structural framework must be assembled first, but one also recognizes that the framework is not designed for earth loads and thus cannot support heavy equipments being moved about freely. Also there is the inherent requirement for minimizing construction crew complements and the time they must spend in space. When these two factors are taken into account, attempts are made to combine as many construction tasks as possible and to automate or semi-automate the most repetitive ones. The satellite design concept places yet another constraint on the construction task.

SPECIFIC CONSTRUCTION TASKS

William V. McRae, Jr., Rockwell International
3322 South Memorial Parkway Huntsville, Alabama 35801

System and subsystem elements are defined as to modular sizes and masses within the constraints of manufacturability and earth launch vehicle payload dimensional limits, therefore, construction processes and equipments must be designed to accommodate these elements. Examples of some SPS hardware are depicted in Table 1. The elements shown comprise approximately 72% of the overall satellite mass. (Addition of the high-density klystrons to the masses shown would account for almost 95% of the estimated operational satellite mass).

SPS ELEMENT	PACKAGING	PACKAGE DIMENSIONS	NO. REQUIRED	NOTES
STRUCTURES	CASSETTES OF ALUMINUM TAPES		1188	6 DIFFERENT TAPE LENGTHS 2500 KG AVE MASS
SOLAR BLANKETS	ROLLS		1632	750 M LENGTH/ROLL 7136 KG/ROLL
REFLECTORS	ROLLS OF FABRIC-HINGED ALUMINIZED KAPTON SHEET		144	 • 32 "HINGED" PANELS • 12,780 KG/ROLL
MW ANTENNA WAVEGUIDE PANELS	SUB ARRAYS		6993	<ul style="list-style-type: none"> • ALL SUBARRAYS HAVE SAME OVERALL DIMENSIONS • 10 DIFFERENT POWER MODULE SIZES - QUANTITY VARIES WITH SIZE • SUBARRAY MASS (AVE) = 716 KG

Table 1. Cargo Packaging

The construction tasks, when defined and combined into an integrated schedule, establish a timeline for construction mass flow demands. These demands must be satisfied by the space transportation systems, i.e. a traffic model will have to be established as a function of time and hardware elements. An example of satellite construction demands and HLLV delivery capabilities is shown in Figure 2. In the presentation, specific construction tasks will be discussed to illustrate how these demands are developed.

SPECIFIC CONSTRUCTION TASKS

William V. McRae, Jr., Rockwell International
3322 South Memorial Parkway Huntsville, Alabama 35801

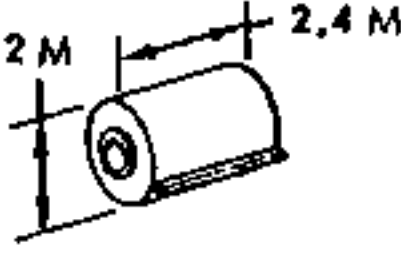
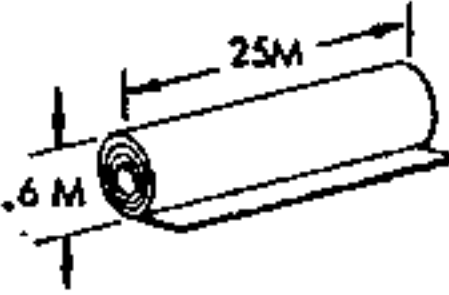
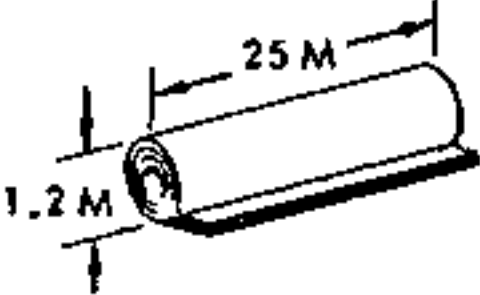
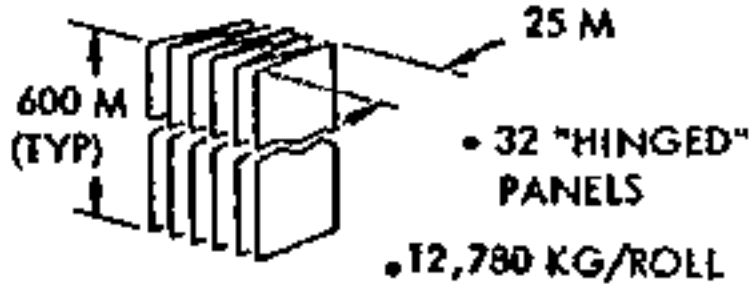
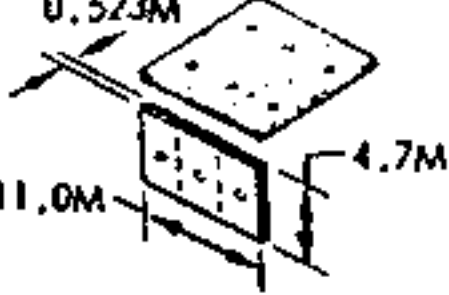
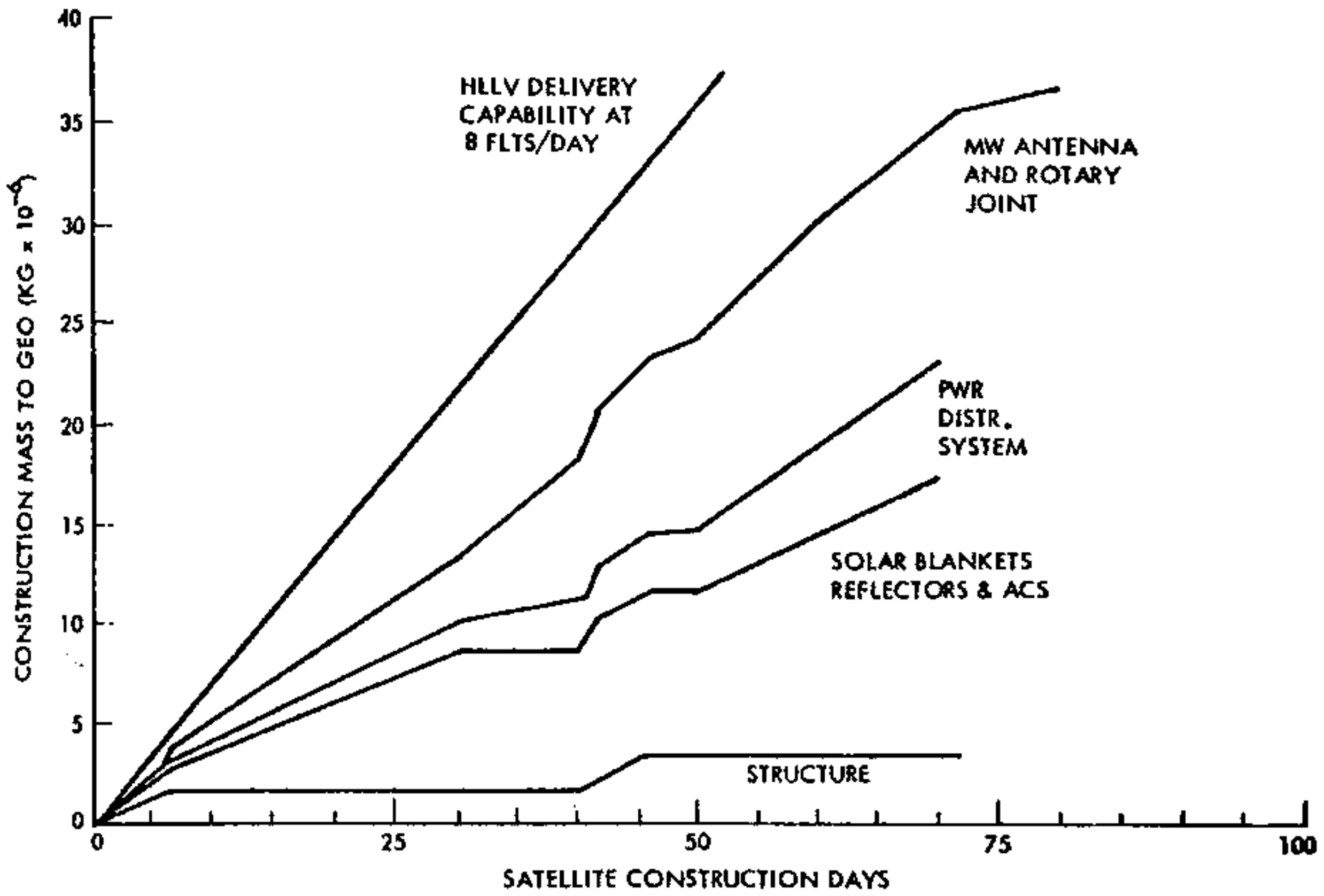

Figure 2. Mass Flow Demands for Satellite Construction

SPECIFIC SPS CONSTRUCTION STUDIES: CONSTRUCTION TASKS-CONSTRUCTION BASE

Ronald W. McCaffrey

Grumman Aerospace Corporation, Bethpage, N.Y.

ABSTRACT

This paper discusses a concept for building the 5000 MW reference Solar Power Satellite in earth orbit, based on recent work performed for NASA/JSC under contract to Boeing, on the SPS System Definition Study, and on related work performed under Grumman IRAD.

INTRODUCTION

Several concepts have been recently described on how to build the Solar Power Satellite (SPS) in space. These concepts entail fabrication and assembly of the entire satellite in geostationary earth orbit (GEO), at 35800 km altitude, as well as partial construction at an intermediate low earth orbit (LEO) followed by final assembly in GEO. A concept for building the entire 5000 MW reference satellite in GEO is discussed below. Construction base operations needed to produce one SPS every six months are described and areas for near term technology development are identified.

GEO CONSTRUCTION BASE

The GEO Base concept shown in Fig. 1 was developed to build the 5000 MW reference SPS system, which uses silicon solar cells with no concentration. This 4 Bay End Builder construction base was selected for further definition in the Phase 2 study because it offered greater production capability than other concepts investigated in Phase 1. The GEO construction base is configured to avoid free flying facilities and/or assembly methods. As a result, the base has contiguous facilities for concurrent assembly and subsequent mating of the satellite energy conversion system and its power transmission antenna. The overall base is 3.44 km wide x 3.65 km long x 0.9 km deep. The base structure serves as an assembly jig which houses the required construction equipment and supports the emerging satellite during all phases of construction. The top deck of the GEO base, level J, provides facilities for cargo docking/unloading and distribution, crew quarters, command and control operations, orbit transfer vehicle (OTV) docking and servicing, and SPS maintenance support complex. Base electrical power and flight control subsystems are also provided so that all work facilities and crew support facilities can operate, as needed.

GEO CONSTRUCTION OPERATIONS

The personnel needed to activate the 4 Bay End Builder Construction Base must travel first by means of the Shuttle to LEO and finally, by means of an orbital transfer vehicle (OTV) which operates from the LEO base.

The 4 Bay End Builder Base assembles the 5 GW reference Solar Power Satellite entirely in geosynchronous orbit, as shown by the construction sequence shown in Fig. 2. The 8 bay wide satellite energy conversion system is constructed in two successive passes on one side of the base, while the microwave antenna is assembled on the other side of the base. During the first construction pass, the GEO base builds one-half of the energy conversion system, a 4 bay wide strip by 16 bays long. When this part of the satellite has been constructed, the base is indexed back along the edge of the structure to the first end frame. During the second construction pass, the remaining 4 bay wide strip is attached directly to the assembled satellite systems. Throughout the construction operation, SPS construction materials and components will be delivered by large electric orbital transfer vehicles (EOTV). These vehicles

will stationkeep at least 1 km away, while special cargo tugs transfer material pallets. GEO base crews will, of course, also be rotated as needed. At the end of the second pass, the base is then indexed sideward to mate the antenna with the center line of the energy conversion system. After final test and check out, the base separates from the satellite and is transferred to the next orbital position for SPS construction.

The reference scenario requires that one 5 GW satellite is to be constructed every six months for 30 years. In order to carry out this program, nearly 450 space workers would be needed on two daily shifts (10 hours each) to perform construction, base support, maintenance, safety and base management operations.

BASE CONSTRUCTION SYSTEM

The end builder construction system described above uses ten synchronized beam machines to automatically fabricate continuous longitudinal beams for the energy conversion system. Lateral and diagonal members of the structural assembly are fabricated with three mobile beam builder substations. The assembly sequence, as shown in Fig. 3, begins with assembly of the first end frame and its attachment to the longitudinal members. This frame is automatically indexed away as the synchronized beam builders fabricate the required length of longitudinal beam to complete the structural bay. During these operations, solar array blankets and power busses are installed in parallel. For example, Fig. 4 shows how the solar array blankets might be temporarily anchored to the base so that they can be automatically deployed during longitudinal beam building operations. The illustration also shows two cherry pickers prepared to handle and connect opposite ends of a 667.5 m solar array support beam to the SPS frame after it emerges from the 12.7 m beam builder.

NEAR TERM TECHNOLOGY EMPHASIS

Constructing the large skeletal structure of the energy conversion system (5.35 km x 10.78 km x 0.47 km), including the installation and check out of its subsystems, will not be an easy task. While plausible concepts have been derived and limited development work has been started on auto-fabrication, a great deal of additional analysis and technology development work needs to be done before we can have confidence in the practicality of this process. For example, future dynamic analysis of the satellite construction process may show that some techniques can impose stringent load conditions on the elements of the satellite, while other techniques do not. As the reference SPS concept matures, all aspects of the construction approach must be analyzed further and periodically re-examined by considering technology issues related to the satellite design, orbit construction location, base facilities, crew and operations. These efforts should also be supported by laboratory investigations of SPS construction issues related to structural fabrication and assembly, construction support and subsystems assembly methods. This effort should be focused on developing technology which can lead toward SPS beam builders, SPS beam handling, subsystem assembly, mating of large space structures and techniques for deploying/installing SPS non-structural subsystems. Subscale prototype demonstrations should be used, wherever practical.

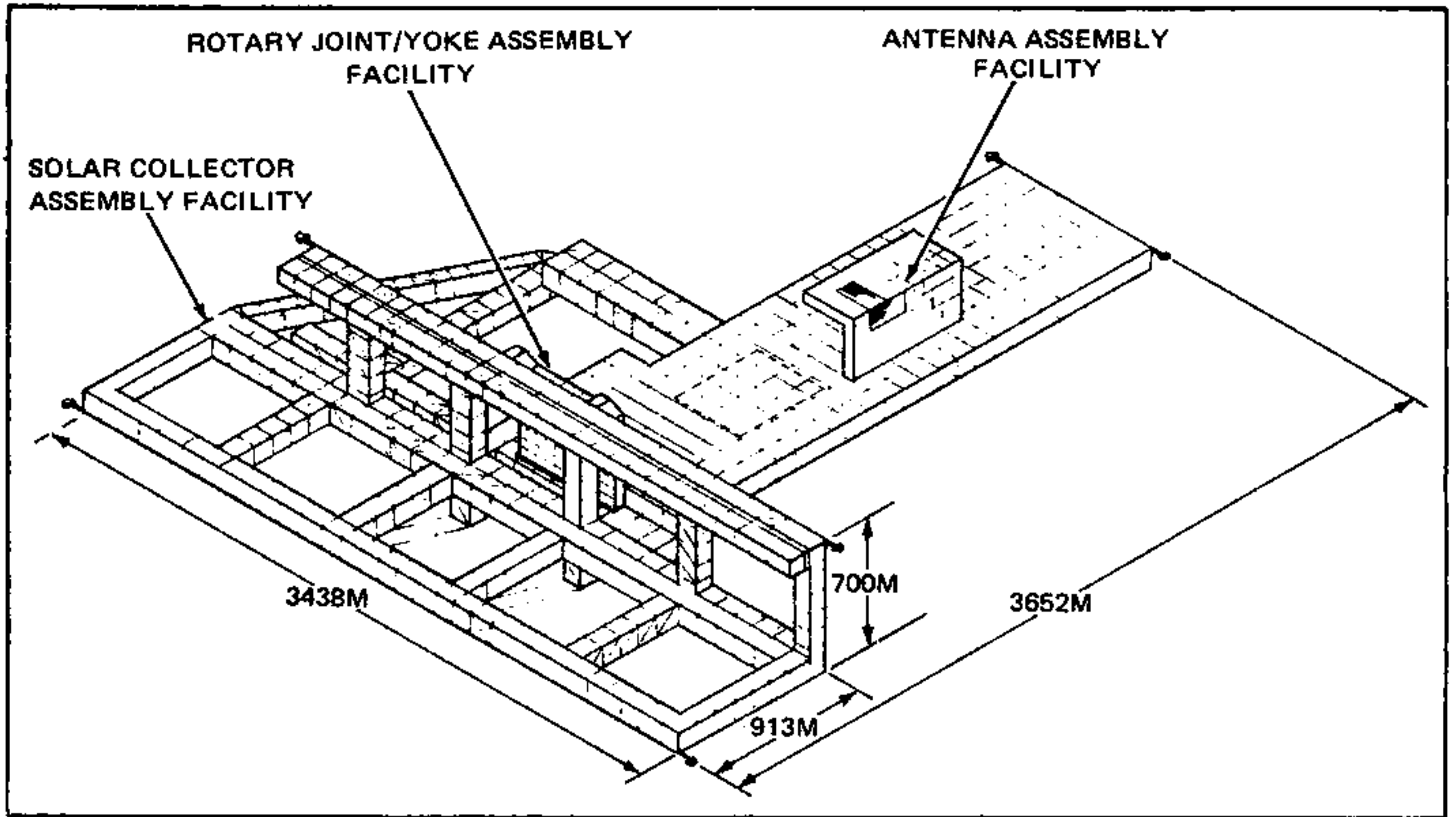
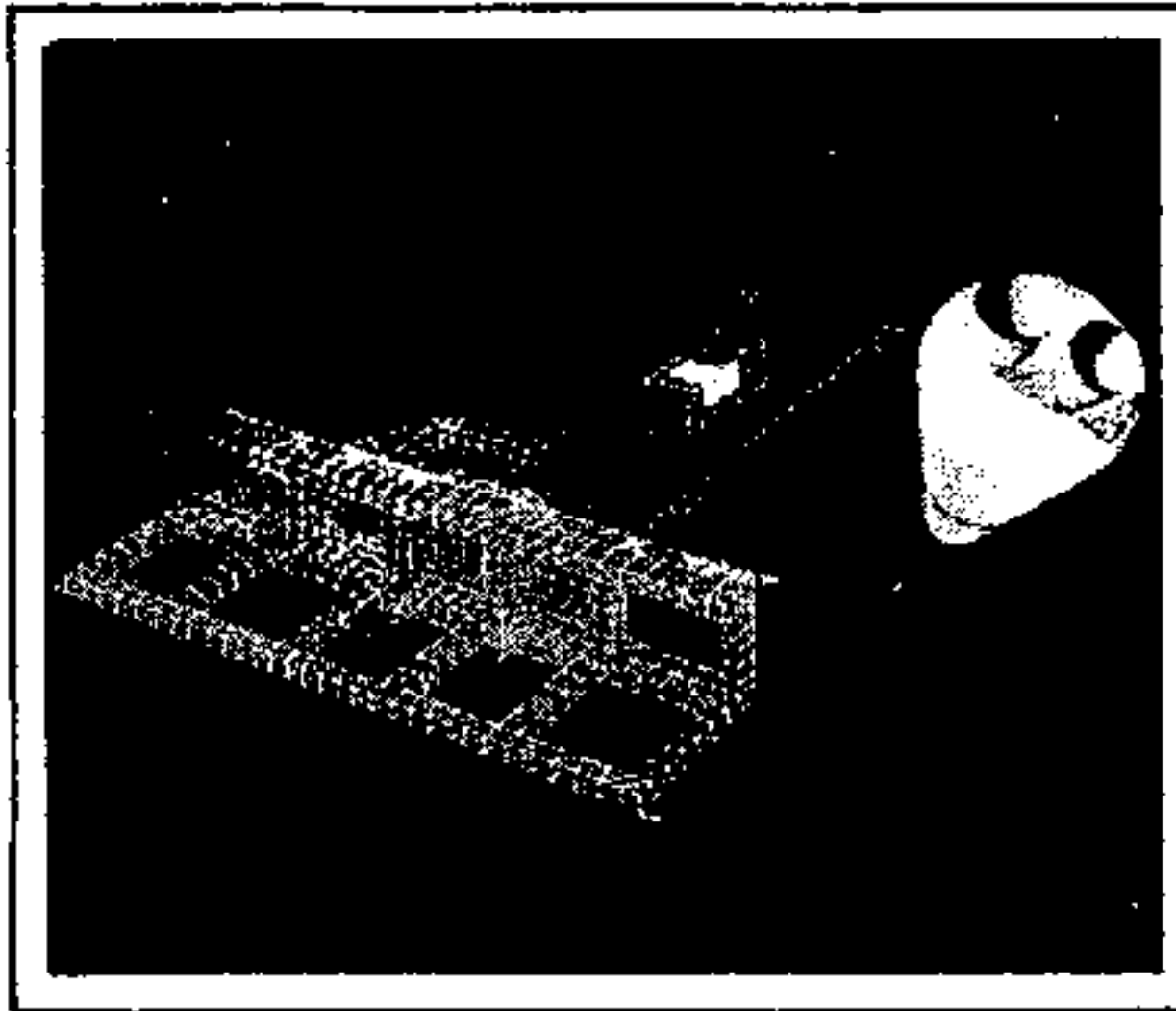
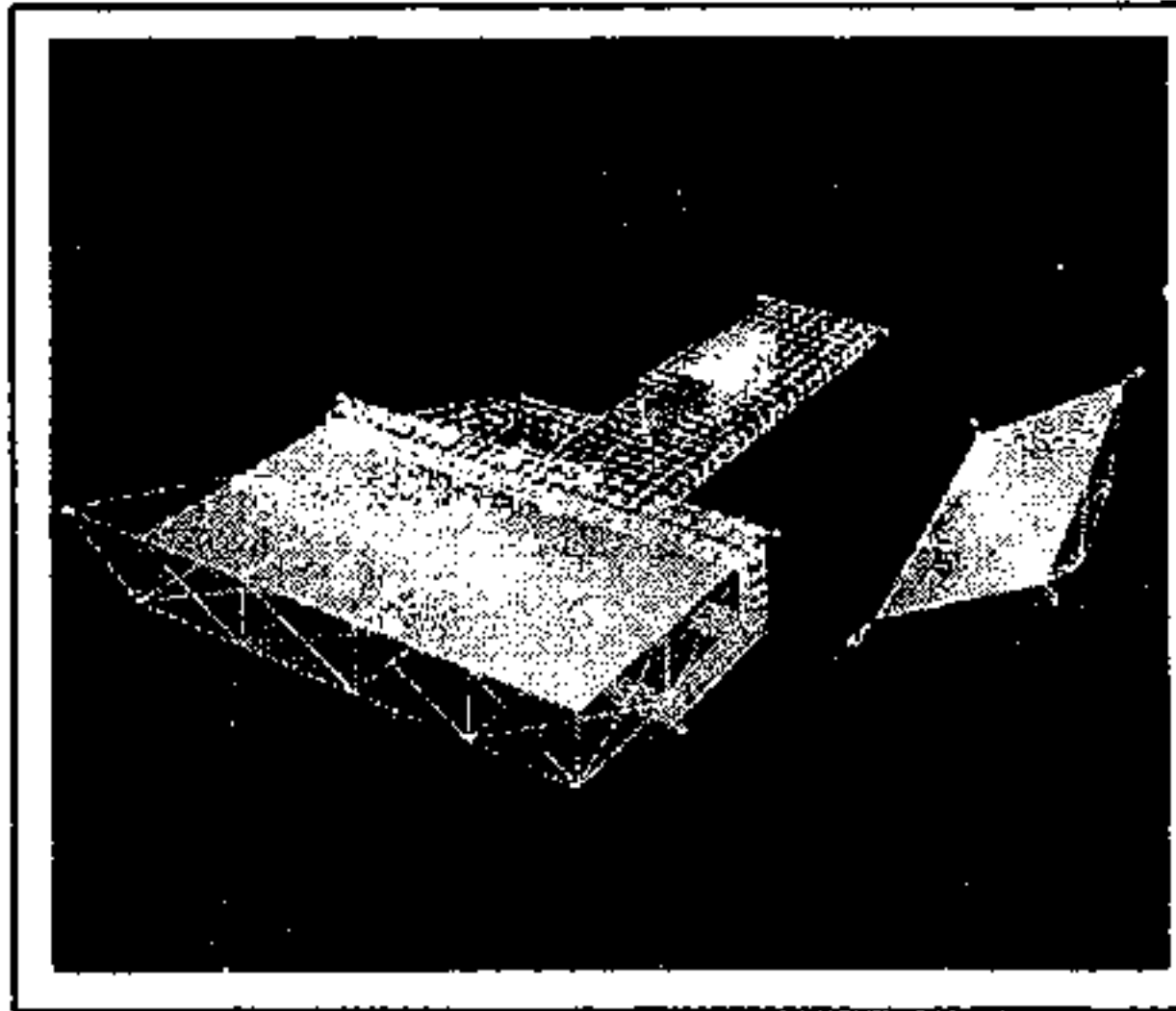

Fig. 1 4 Bay End Builder Construction Base



ACTIVATE GEO BASE



FIRST CONSTRUCTION PASS

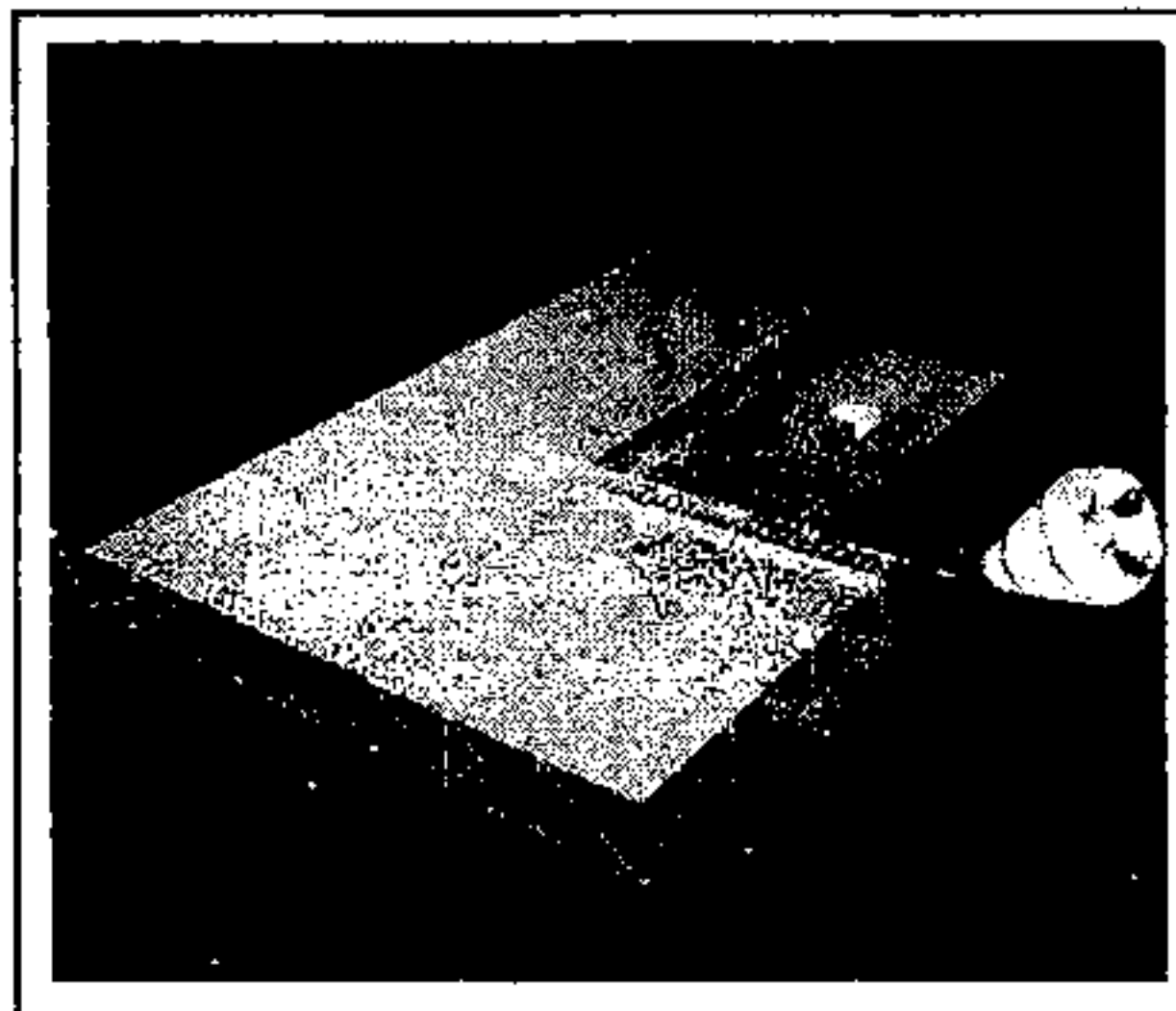

SECOND CONSTRUCTION PASS

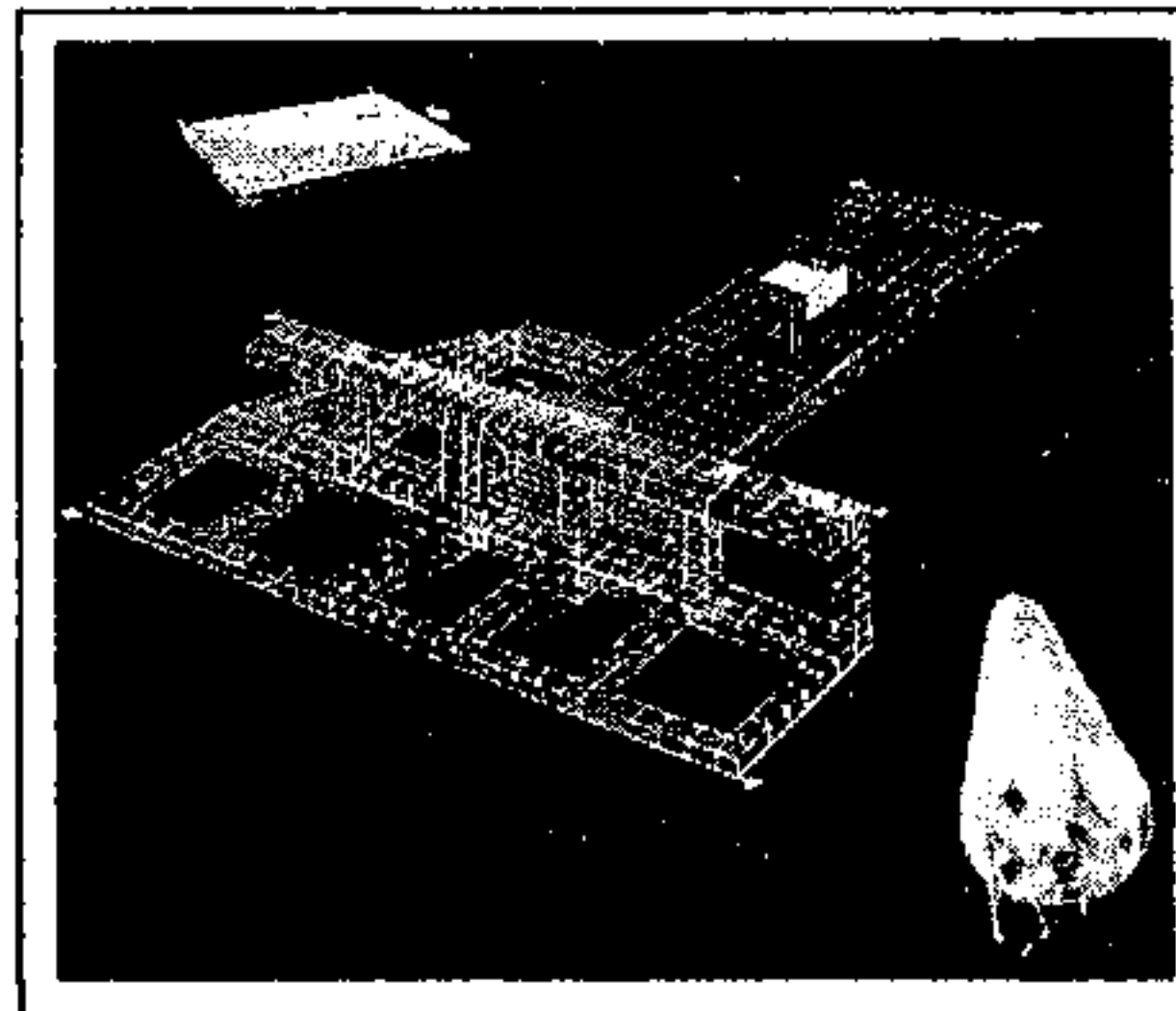

CHECKOUT SPS & TRANSFER BASE

Fig. 2 SPS - 4 Bay End Builder Construction

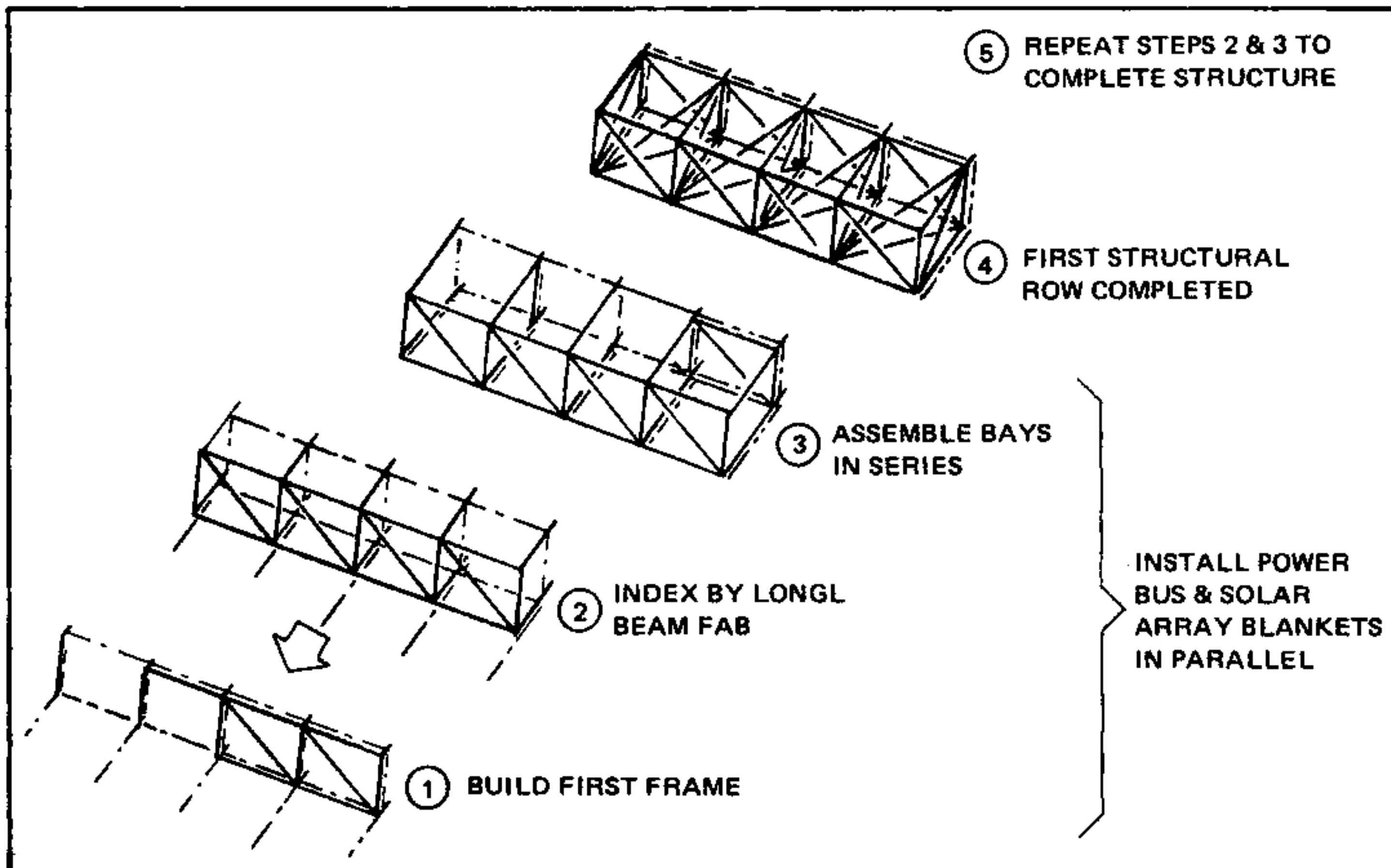

Fig. 3 End Builder Structural Assembly Sequence

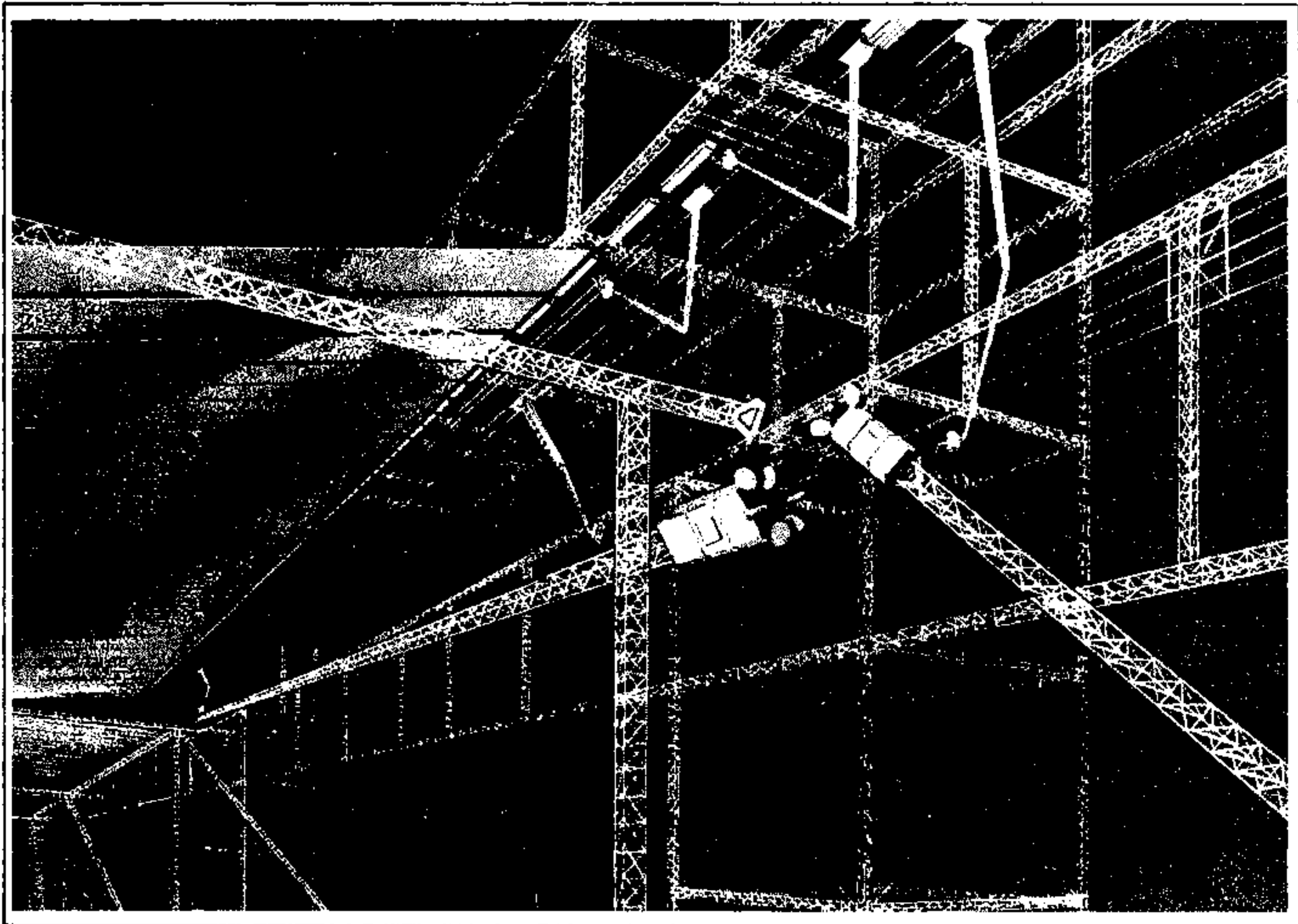

Fig. 4 SPS Assembly Operations

CONSTRUCTION OF THE SPS PRIMARY STRUCTURE BY ANOTHER METHOD
By Thomas C. Taylor - Independent Contractor
136 South Virgil Ave., Suite 310, Los Angeles, CA 90004 (213) 487-5137

The SPS primary structure contains about 10,000 tons of long fragile structural members. This framework can be built using aluminum foam. Not all members are carrying the same loads, so a method which allows the member to be modified to accommodate various loadings would be cost effective.

The aluminum is salvaged from expended external tanks. Each ET contains 63,000 lbs. of aluminum and this material could be the least expensive basic building material we will see in space for many years. The ET reaches 99% of full orbital velocity prior to being jettisoned and forced back into the atmosphere. The ET re-entry location is assured by tumbling the tank to increase its aerodynamic drag on the upper atmosphere. Taking the ET into orbit may increase the performance of the orbiter by eliminating the rollercoaster maneuver performed to force the tank back into the atmosphere.

The concept is to melt down the tank using a direct solar smelting device, inject an agent which produces the foamed aluminum and shape it to any section desired. The smelting process can be adapted to other applications and promotes containerless processing in near zero gravity environments. The machines designed to shape the foam can be continuous and do not appear to be far ahead of present surface technology. A solid core cylinder could be produced easily, but a hollow cylinder would be more cost effective. A machine capable of producing a 25 foot diameter hollow foam cylinder can be carried into orbit using the aft cargo compartment (ACC) of the external tank. The machine can vary the thickness of the foamed aluminum to manufacture a section capable of accommodating a variety of member loadings.

The advantages of this construction system include savings in launch costs, faster construction rates, possible lower cost structures, promotes containerless processing in orbit, uses almost any space debris, and it frees the shuttle cargo bay for other uses. This system offers the added feature of being able to withstand the transportation loads from construction at LEO to use at GEO. The cost savings of using foamed aluminum as 80% of the 10,000 tons of SPS primary structure is approximately 7 billion dollars at today's launch costs. Even at \$10/lb. transportation costs it saves several hundred million dollars in transportation costs.

The ends of the members include long tapered columns and ball joint connections which allow final alignment prior to foaming the sphere joint assembly. The concept has some technical obstacles which can be overcome with research.

We are about to enter the era of space fabricated structural systems. Foamed aluminum in space could be as basic to our building in this new light weight environment as concrete is on the surface. This concept could provide a less expensive route to an SPS Test Article without the large up-front investment in the next generation of lift vehicles. This concept could change the character and shape of space construction systems in the future by utilizing the expended external tank as a low cost raw material.

Mission Sequence ET In Orbit

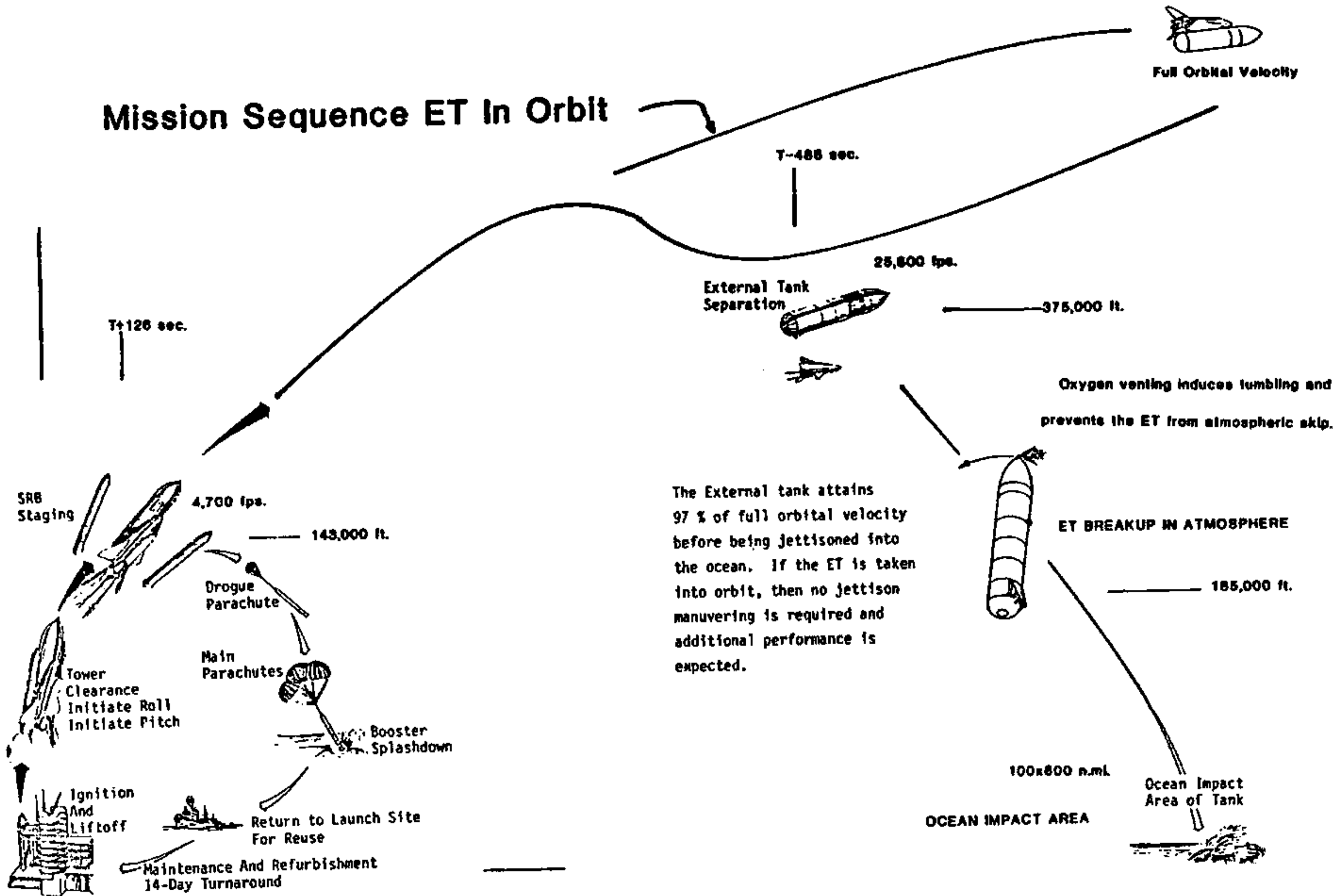

The External tank attains 97 % of full orbital velocity before being jettisoned into the ocean. If the ET is taken into orbit, then no jettison maneuvering is required and additional performance is expected.

**SOLAR
SMELTING**
56,700 lbs.



**63,000 lbs.
ALUMINUM/TANK**

**ET IN ORBIT
WITH A.C.C.**



**TAKE
ET
INTO
ORBIT**

**ALUMINUM
FOAM**

**A.C.C.
MACHINE
FORMING**

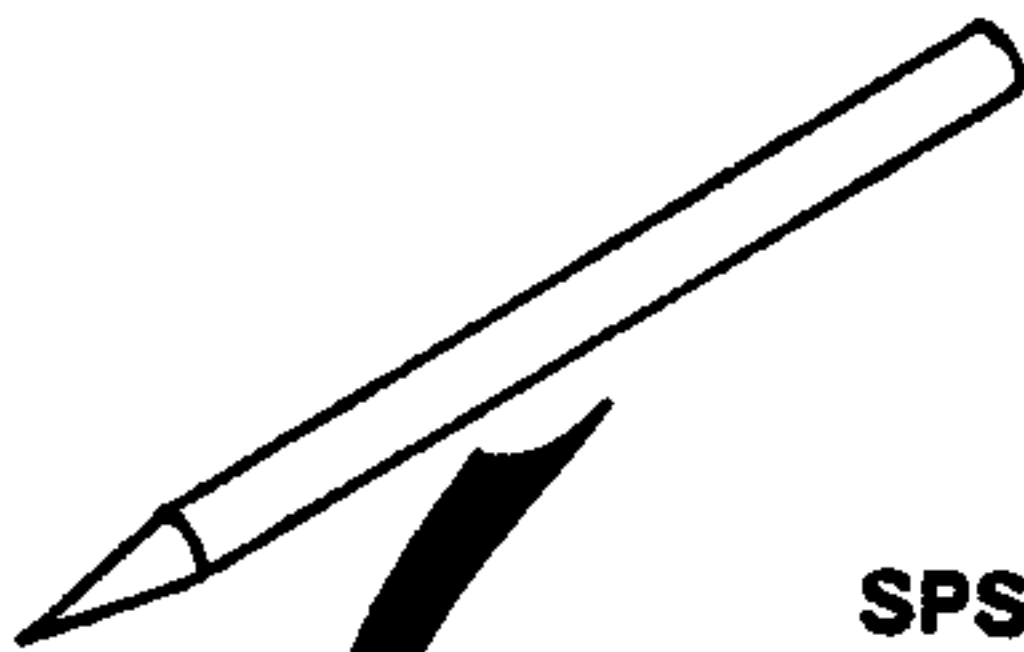
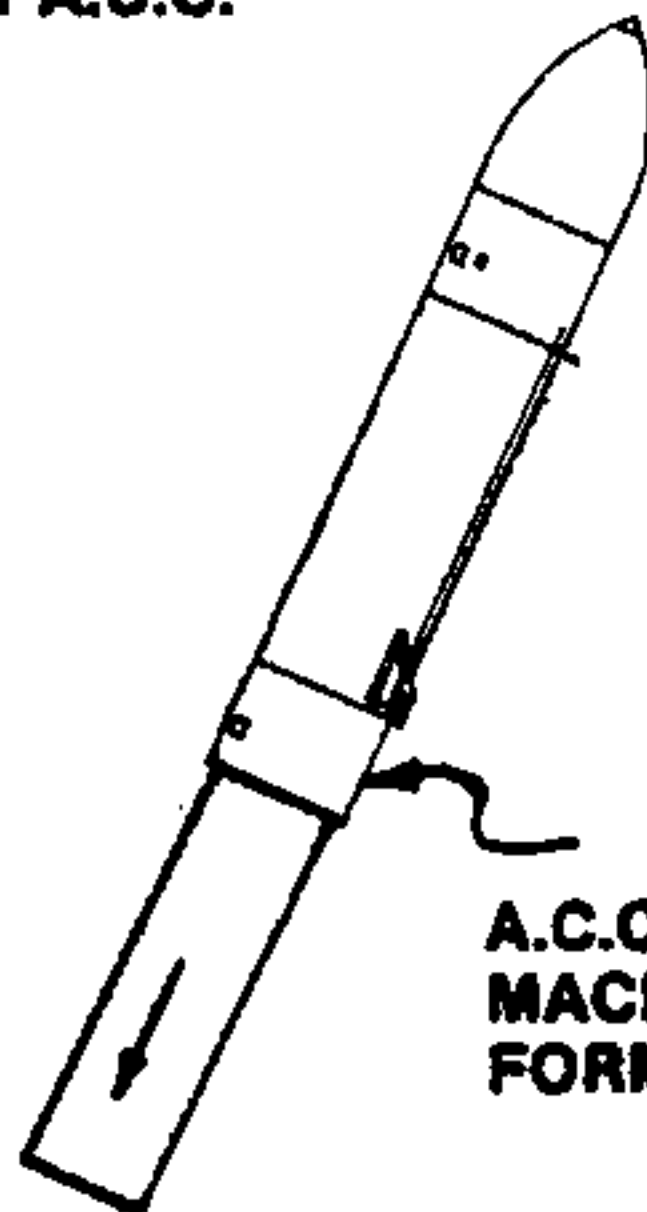

SPS FRAME
20,000,000 lbs.

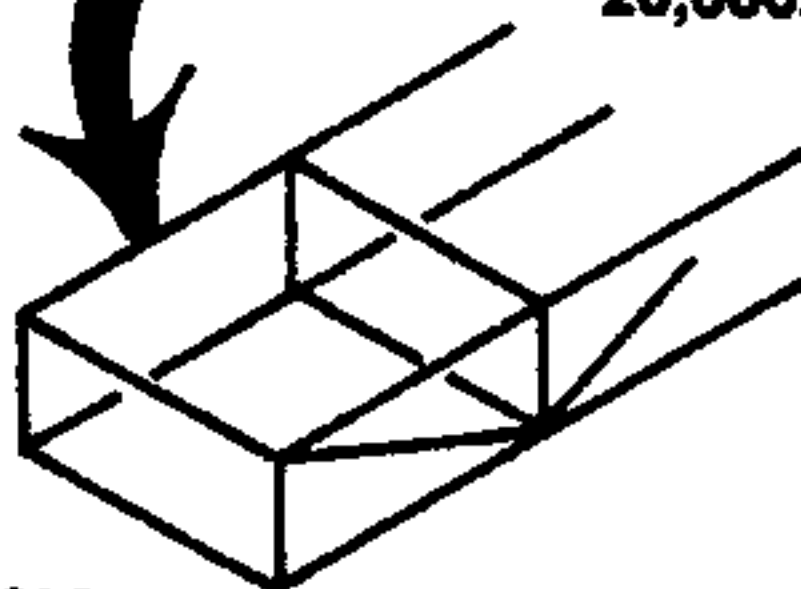

SPECIFIC SPS CONSTRUCTION STUDIES: OPERATIONS AND MAINTENANCE

Keith H. Miller

Boeing Aerospace Company, P.O. Box 3999, Seattle, Washington 98124

The overall scope of the Solar Power Satellite program operations is depicted in Figure 1. These operations involve many surface as well as in-space operations. In this discussion, we will take a look at these operations using the 12th year of commercial operations as a model. During this time period, the primary end products of SPS industrial enterprise are the following: 1) operation and maintenance of 20 satellites, 2) completion of a new SPS and its ground receiving antenna every 6 months, and 3) construction of electric cargo orbital transfer vehicles (EOTV's) at the rate of one vehicle every 45 days. EOTV's are not constructed every year of SPS operations; we have selected a year including EOTV construction for completeness.

During the 12th year of commercial SPS operations, the industrial infrastructure will be producing the materials and components required to support the space construction and ground receiving station construction operations. Studies have shown that the production of photovoltaic cells and blankets will be the most significant new industrial enterprise. Certain other subsystems will require the development of significant new industrial capacity, but the SPS demand seems reasonably comparable with projected capacity to serve other markets. Most of the components can be shipped by rail or truck. A couple of very large components will have to be shipped by barge or ship.

Each ground receiving station includes the land area, rectenna, utility interface equipment, and control and communications systems. The land sites are 13.2 x 18.7 km (nominal at 35° latitude) and each rectenna is 9.9 x 14 km. Each ground receiving station would be constructed over a 24 month period. Four of these sites would be in work simultaneously so that the receiving stations are brought on-line at the rate of one every 6 months (the same as the SPS construction rate).

Satellite components and propellants are delivered to the launch site at the Kennedy Space Center. Heavy lift launch vehicles are loaded with 1 million pound payloads. There will be 1 or 2 launches each day from three off-shore launch pads. Space crews are launched by a dedicated vehicle.

The cargo and crews are delivered to a low Earth orbit staging base (the LEO Base shown in Figure 2). Some of the cargo and crew remain at this base where electric orbital transfer vehicles (EOTV's) will be constructed at the rate of one vehicle every 45 days. The majority of cargo is transferred to an EOTV which is flying in formation with the base. The EOTV's will deliver the cargo to the geosynchronous Earth orbit base (the GEO Base). Crews will be delivered to GEO by dedicated personnel orbit transfer vehicles (POTV's). There will be approximately 230 people at this base.

The GEO base is shown in Figure 3. This base is used to construct the solar power satellites, and to support the SPS maintenance operations. The SPS construction operations are conducted at a rate to produce a new satellite every 6 months. The solar array portion of the satellite and the antenna are constructed simultaneously in the two main construction areas on the base.

The satellite maintenance operations include two primary sub-operations: 1) The

maintenance that is performed at the satellites, and 2) the refurbishment of defective satellite components at a maintenance depot on the GEO Base.

A crew of maintenance workers are delivered to the GEO Base twice a year. These crew members are then delivered to an operational satellite along with some maintenance equipment and some replacement parts. Over a 3½ day period, defective components are removed and replaced with new ones. The defective components are returned to the GEO Base. The crew, mobile maintenance equipment, and replacement parts move on to the next satellite. They repeat these maintenance operations as they visit 20 satellites over a 90 day period. The crew and equipment are returned to the GEO Base at the end of their tour and the crew is returned to Earth.

At the GEO Base, the defective components are delivered to maintenance modules. These parts are individually tested to diagnose their fault conditions and then they are sent through a production line where they are torn down to the extent required to replace the defective components. The components are then reassembled and tested. They are then returned to storage for eventual delivery to the satellites for reuse.

The space crews work on a 6-day-per-week, 10-hours-per-day work schedule. They are returned to Earth after 90 days and are replaced by crew members who have been on Earth for 90 days.

Each of the operational satellites beam power back to its ground receiving station where the microwave energy is converted to electrical energy which is then delivered into the utility power grid.

All of these operations are coordinated and controlled by operations control people, facilities, and systems.

Table 1 shows our estimate of the total number of people who will be directly involved in the SPS program during this 12th year of production.

Reference: Solar Power Satellite System Definition Study, Vol. III, Phase II Final Report, Operations and Systems Synthesis, (Contract NAS9-15636), The Boeing Aerospace Company, D180-25461-3, December 1979.

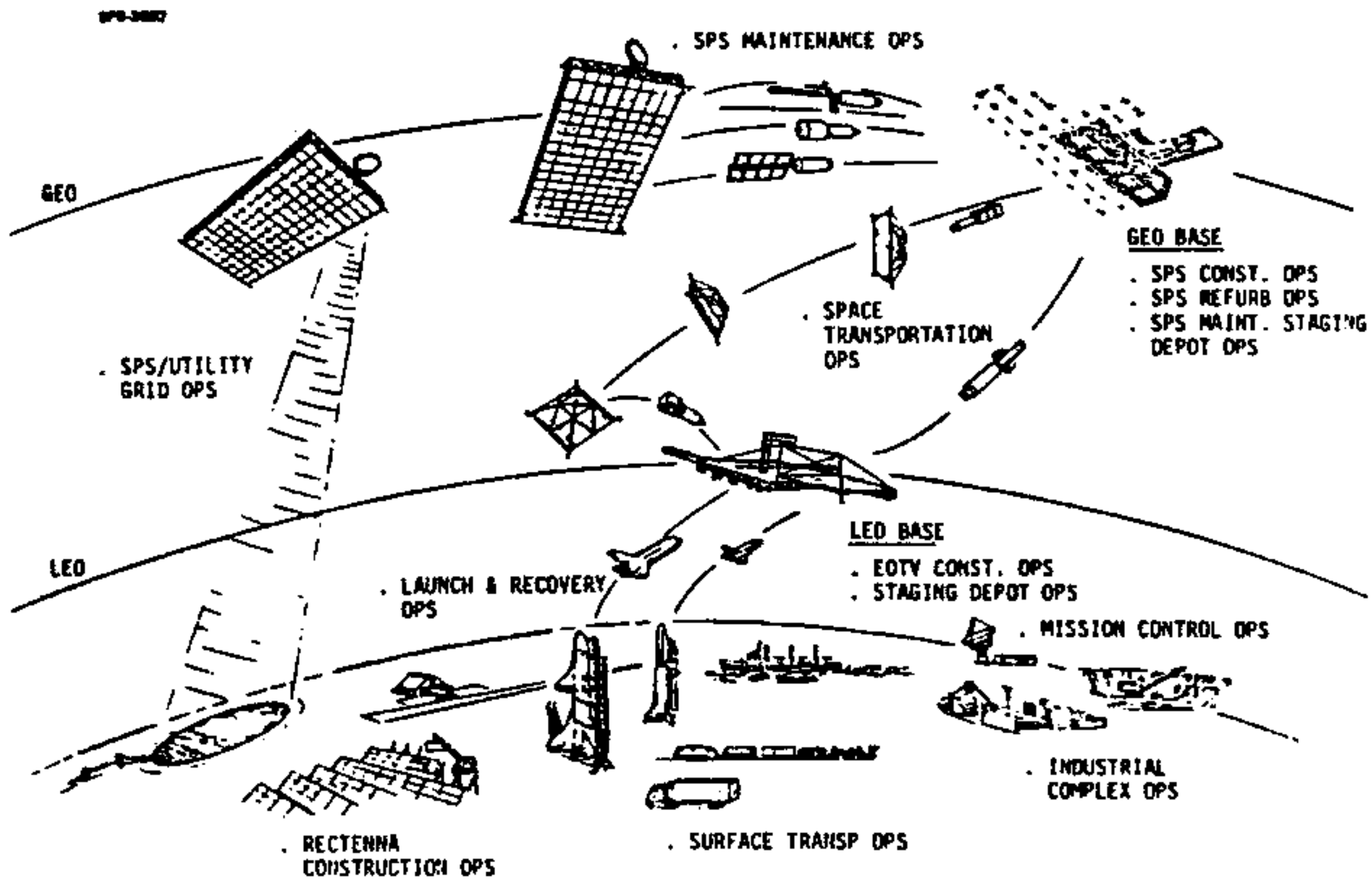

Figure 1 – Integrated SPS Program Operations

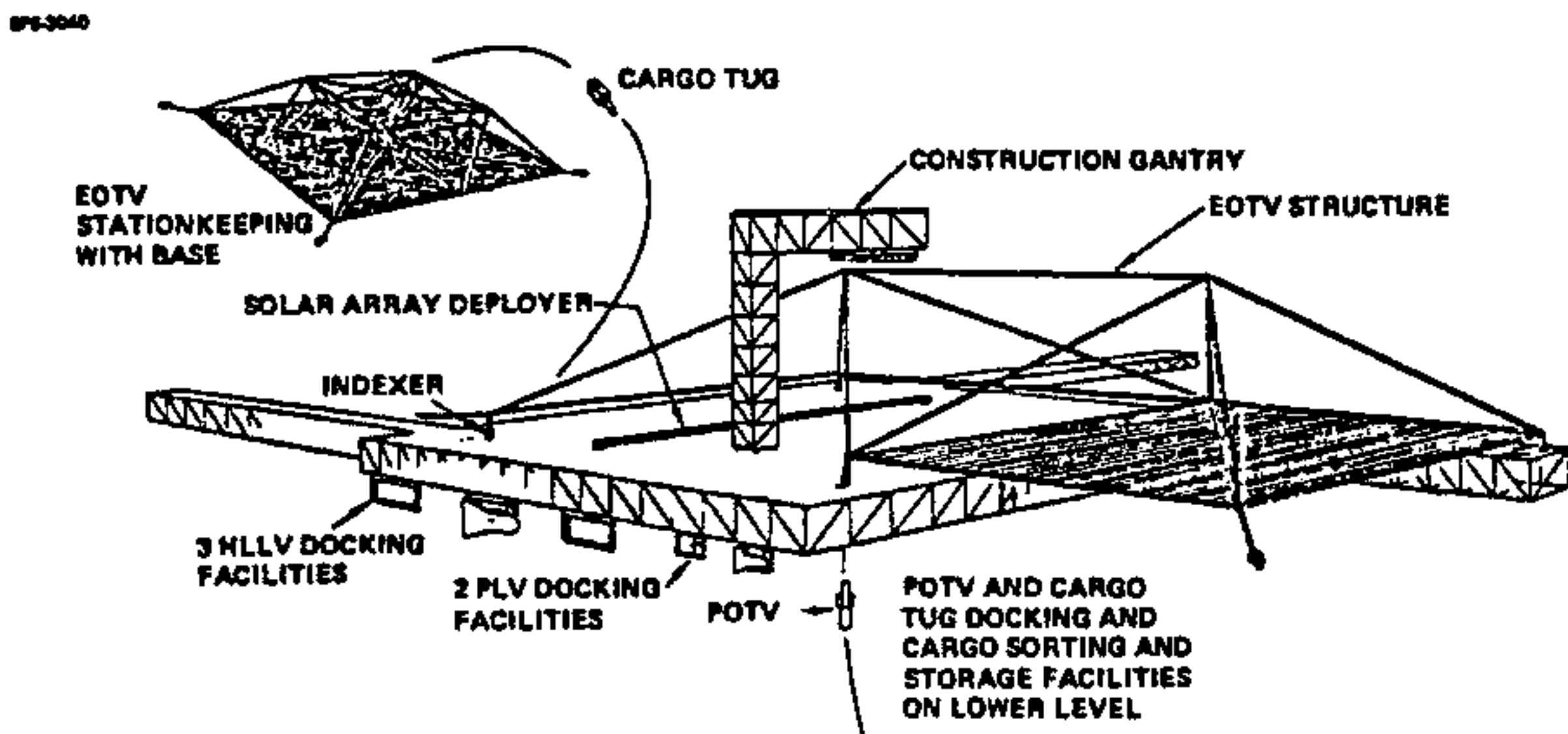

Figure 2 – LEO Base

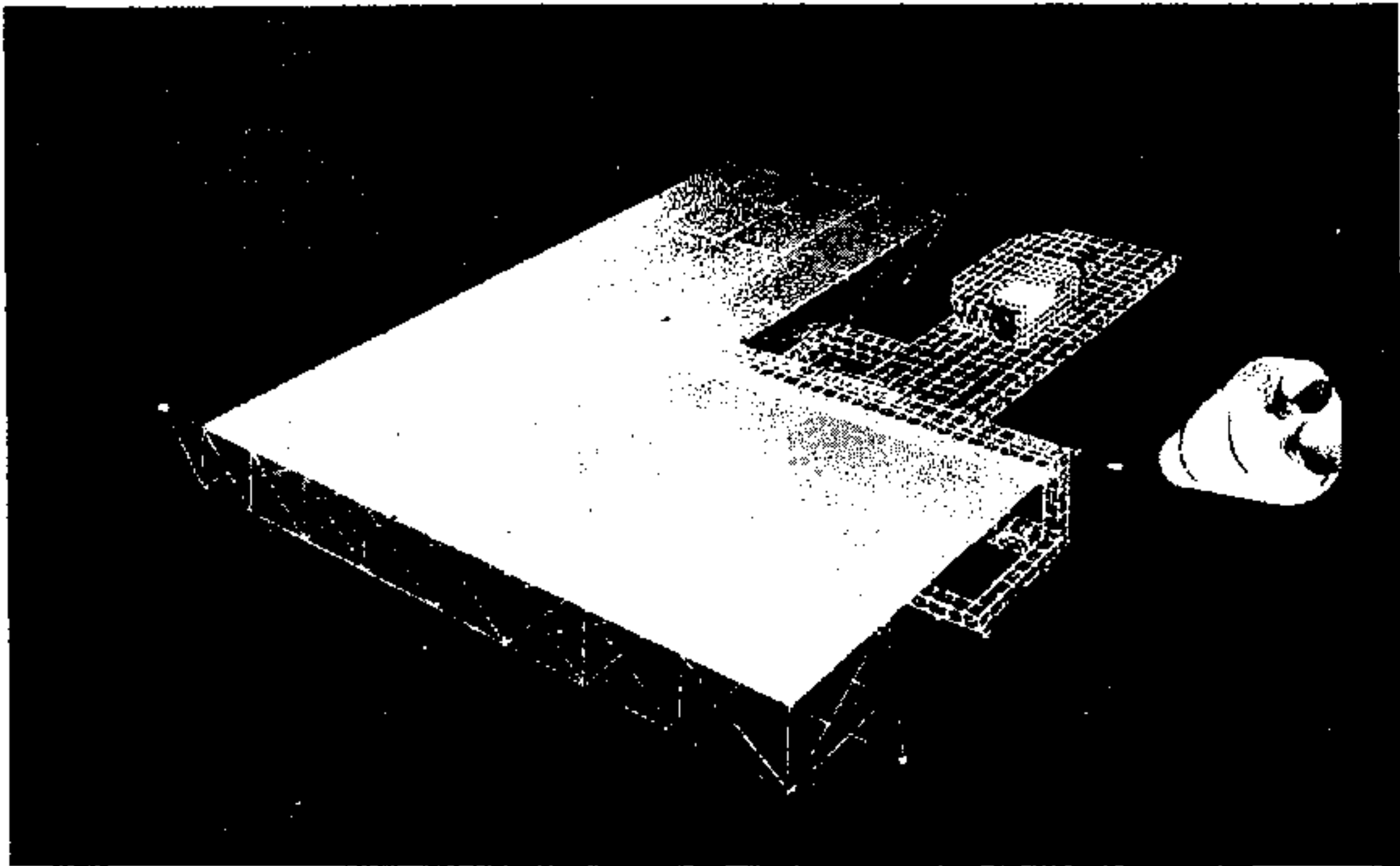

Figure 3 – GEO Base

TABLE 1
SPS PROGRAM MANPOWER ESTIMATE

	Estimated Number of People Req'd During 12th Year of Commercial Operations (20 SPS's in operation)
o Industrial Complex/Surface Transportation Operations	500,000
o Rectenna Construction Operations	2,100
o Launch and Recovery Site Operations	6,425
o LEO Base Operations	
o Space Crews	460 ^a
o Ground Support Crews	4,600
o GEO Base Operations	
o Space Crews	888 ^a
o Ground Support Crews	8,880
o SPS Maintenance Operations	
o GEO Base Crews	600 ^a
o Mobile Crew	85
o Ground Support Crews	6,850
o SPS/Rectenna/Utility Grid Operations	7,700
o Operations Control	<u>2,996</u>
Total	542,000 (approx.)

^a Half of these crewmembers will be in space at any point in time. The other half is on the Earth on vacation, receiving training, preparing for next tour of duty, etc.

SPS RECTENNA SYSTEM
R. W. Andryczyk
General Electric Company - Valley Forge, Pennsylvania

This paper addresses the design, construction and cost of the SPS ground receiving rectifying antenna called the "Rectenna". An integrated ground system is deemed feasible if construction of the rectenna is broken up into a number of separate jobs. Each can be described in terms of machines, human resources, and material that would be needed. Automated production would play a major role.

The total cost of the ground power segment is estimated at over \$2 billion, of which two thirds would be the cost of constructing the rectenna.

The rectenna consists of a number of microwave power collectors. Included are approximately 13 billion elements of the low-gain receiving antenna, about 10 Km in diameter, along with about the antenna's 7 billion rectifiers, medium voltage DC power collecting grid, DC/AC converters and high voltage AC power collecting grid.

In principle, all of the elements for the rectenna system are well within the state of the art. The great challenge is to produce economically the huge quantities of components that would be required. This involves keeping the cost of finished components close to the cost of the materials while taking into account such factors as rectenna maintainability, angular alignment requirements, soil mechanics, and environmental conditions at the site.

AUTOMATED CONSTRUCTION OF LIGHTWEIGHT, SIMPLE, FIELD-ERECTED STRUCTURES

R. S. Leonard, P.E.

Bechtel National, Inc.

San Francisco, California

Power plants requiring less labor per kilowatt to build will be cheaper, less affected by inflation, and not as constrained by labor shortages. Recent advances in such diverse fields as industrial automation and autonomous planetary rovers indicate that a synthesis of these advanced techniques could result in mobile construction robots. These robots would perform a limited number of very repetitive tasks at relatively benign construction sites.

The example demonstrating the feasibility of this proposal is the construction of a large photovoltaic power plant having a peak power output of 100 megawatts. This is similar to the support structures proposed for the Satellite Power System (SPS) rectenna. Preliminary cost estimates show that a limited labor force using construction robots could reduce direct labor costs between 23 to 79 percent.

The approach taken in this paper is: to present the reasons to automate the construction process; to define the conventional construction scenario as the reference for evaluation; to list the potential cost benefits by using robots; to demonstrate the technical feasibility of building several possible construction robots; and to show the application to build SPS ground stations. The conclusions in this paper would also apply to underground and surface mining operations, mechanized agriculture, and other industrial situations.

Reasons for Automation: Some of the major reasons for considering automating an assembly task are:

- shortage or unavailability of labor
- low skill level requirements
- increased productivity
- harsh environments
- simple, monotonous, and repetitive tasks
- cost savings

Recent trends in highway construction costs are shown in the attached figures along with a comparison of the cost of labor to the cost of a robot.

In addition, large power plant jobs often see a decline in productivity with respect to small jobs in the same area. This decline is due in part to the size of the job and to the narrow work assignments.

Application: The reason to consider using robots to build either photovoltaic power plants or the SPS rectennas is that these two applications involve all the reasons given above for considering automated assembly.

Either application involves the placement or assembly of a large number of identical structural elements in a very simple environment. A typical support design for each application is shown in the attached figures.

For a 100 megawatt electric photovoltaic power plant, over 250 thousand 4 ft. x 8 ft. panels of cells must be placed on beams. This assembly work will most likely be located in the open desert which provides a fairly simple environment. However, that location is hot, in a remote location, and the work can be considered monotonous.

Potential Savings: A summary of the direct costs (labor and equipment) is given in the attached table and reflects building a plant in a conventional way. This table also shows the potential savings that might be achieved by:

- A. Keeping labor input constant and doubling equipment usage or productivity
- B. Eliminating all direct construction labor and incurring charges for robot or automated assembly equipment equal to equipment rental charges that would be incurred by using present construction practices
- C. Similar to case B but doubling the productivity by using the robots 16 hours per day

Status of Technologies Needed to Produce Construction Robots: To design and assemble a construction robot economically and with little effort various technologies must be sufficiently advanced to permit that effort to proceed without incurring a large development cost.

The technologies involved are:

- Industrial automation
- Microprocessors
- Remotely piloted vehicle technology
- Autonomous planetary rovers

In all cases, the techniques needed to give a construction robot the necessary capabilities have been demonstrated either in actual working environments or field tests of prototype equipment. A fairly brief review of the literature in each of these fields will verify this statement.

In tasks involving uncertainty, one weak area is in the software routines involved in giving the robots limited decision making capabilities. Until more advanced software routines become available, construction robots may be limited to assembly and transportation tasks. Two conceptual designs are shown in the attached figures.

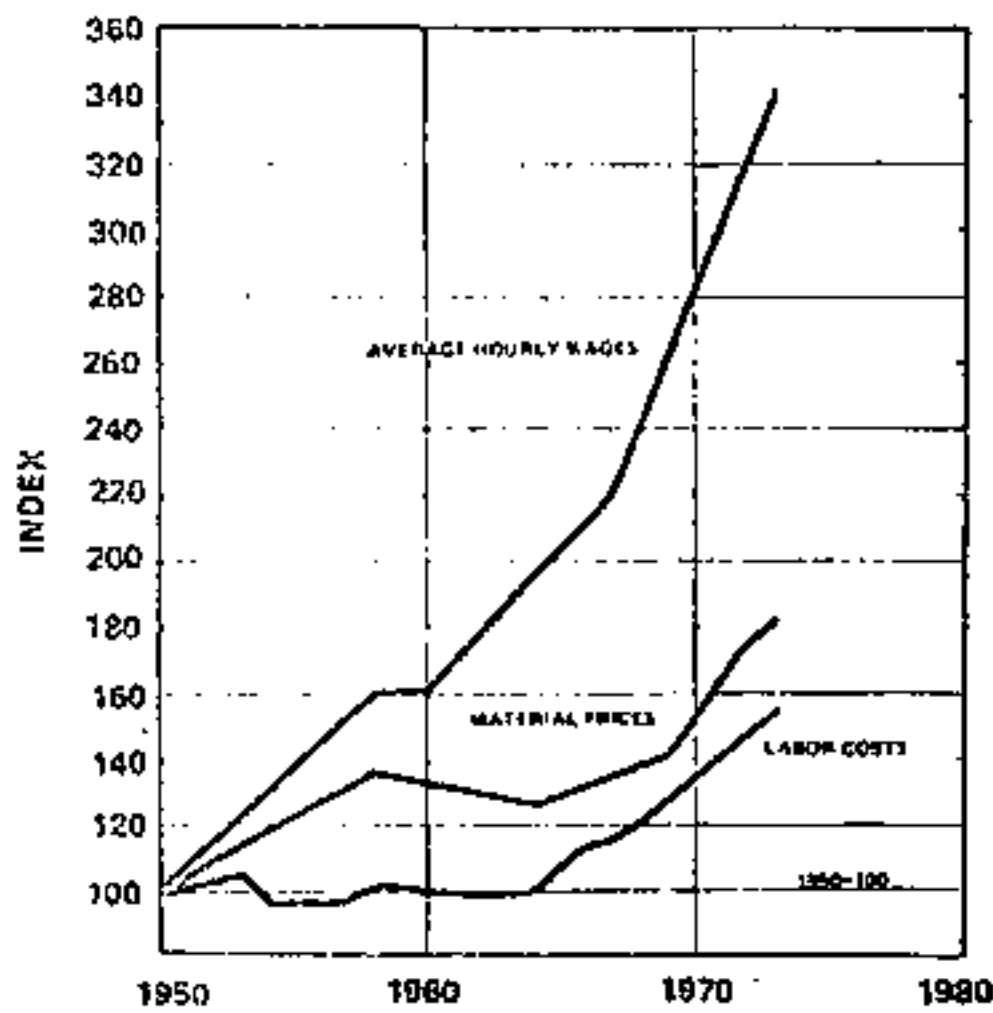

HIGHWAY CONSTRUCTION COSTS

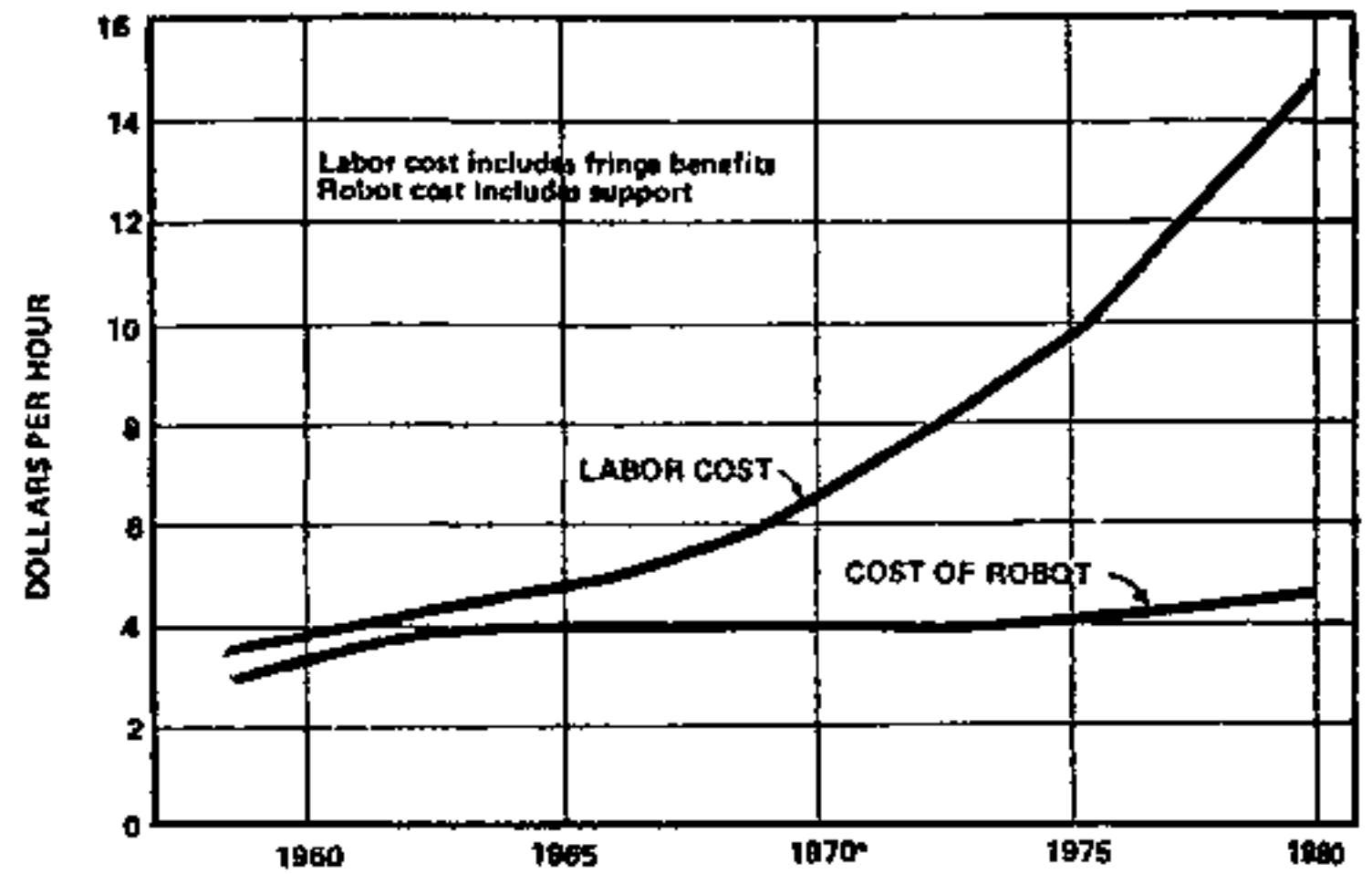

COMPARISON OF HOURLY LABOR COST TO HOURLY CHARGES FOR A ROBOT

CONSTRUCTION COSTS PER 100 MEGAWATTS

PHOTOVOLTAIC PANEL INSTALLATION	DIRECT COSTS 1978 DOLLARS (no overhead, or profit included)		
	Labor	Equipment	Total
	TOTALS	6,086,420	4,421,970

POTENTIAL COST SAVINGS 1978 DOLLARS

POTENTIAL SAVINGS FOR	same labor 16 hour equipment usage	no labor 8 hour equipment usage	no labor 16 hour equipment usage
100 MEGAWATTS INSTALLED	2,210,935	6,086,420	8,297,355
1,000 MEGAWATTS INSTALLED	22,109,350	60,864,200	82,973,550
10,000 MEGAWATTS INSTALLED	221,093,500	608,642,000	829,735,500

(no overhead, frings, or profit included)
(no credit taken for interest saved)

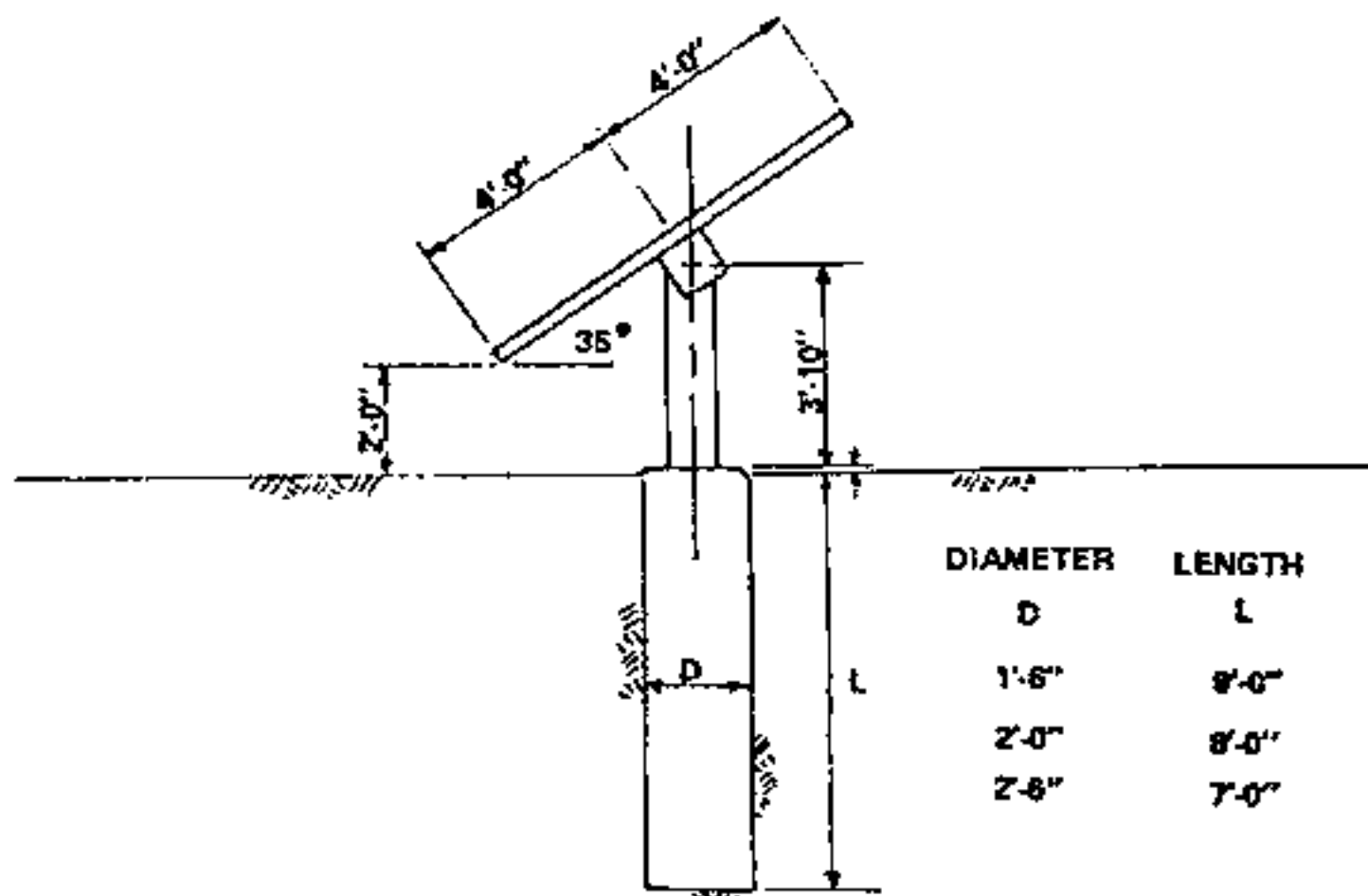

SUPPORT STRUCTURE FOR PHOTOVOLTAIC POWER PLANT

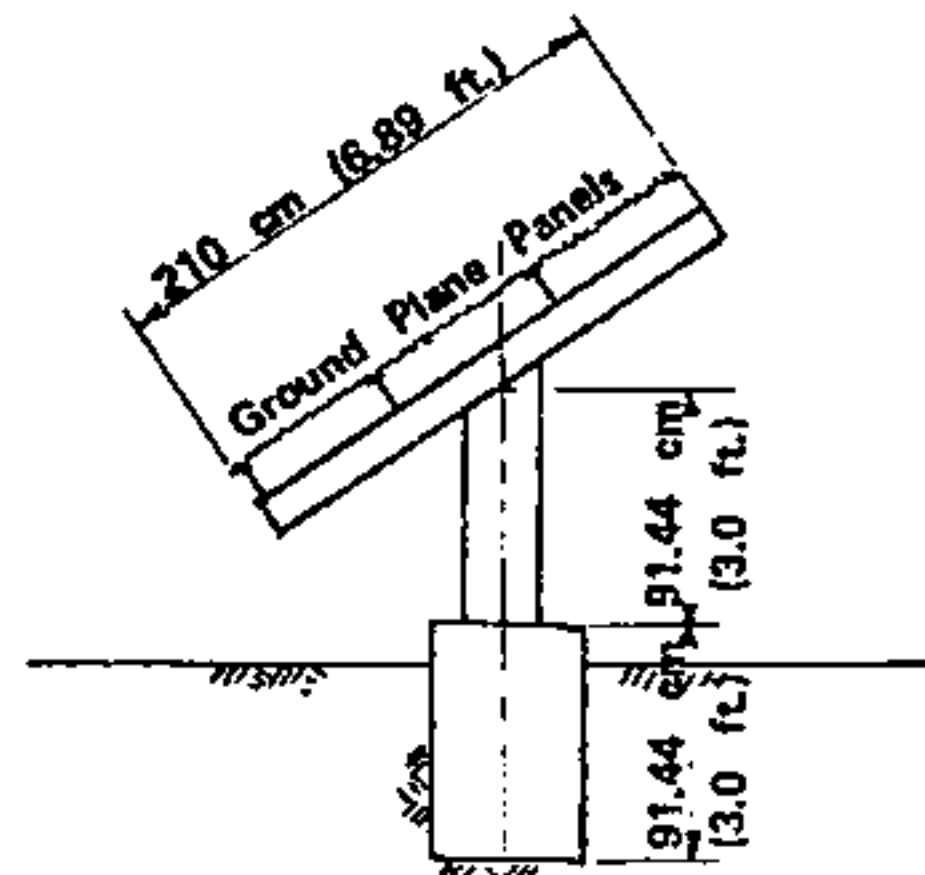

SUPPORT STRUCTURE FOR SPS RECTENNA

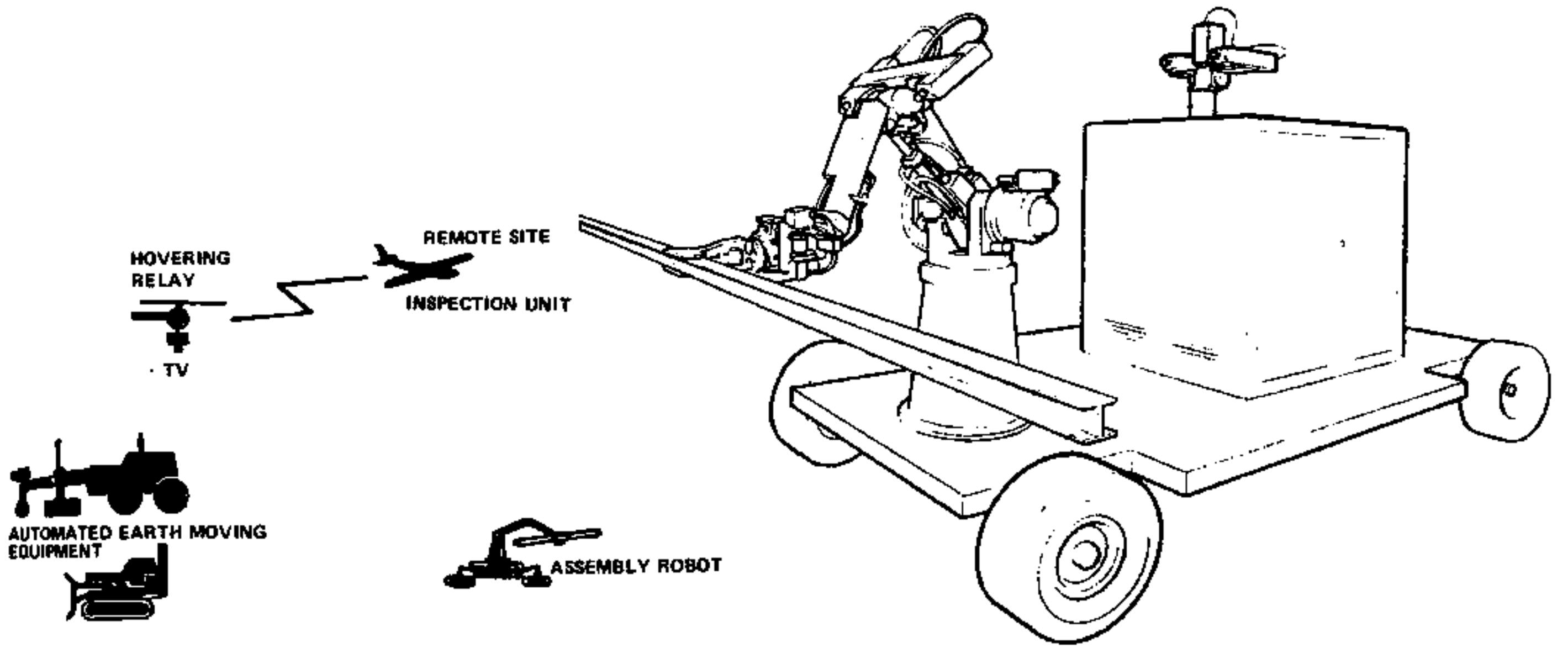

CONCEPTUAL ASSEMBLY ROBOT

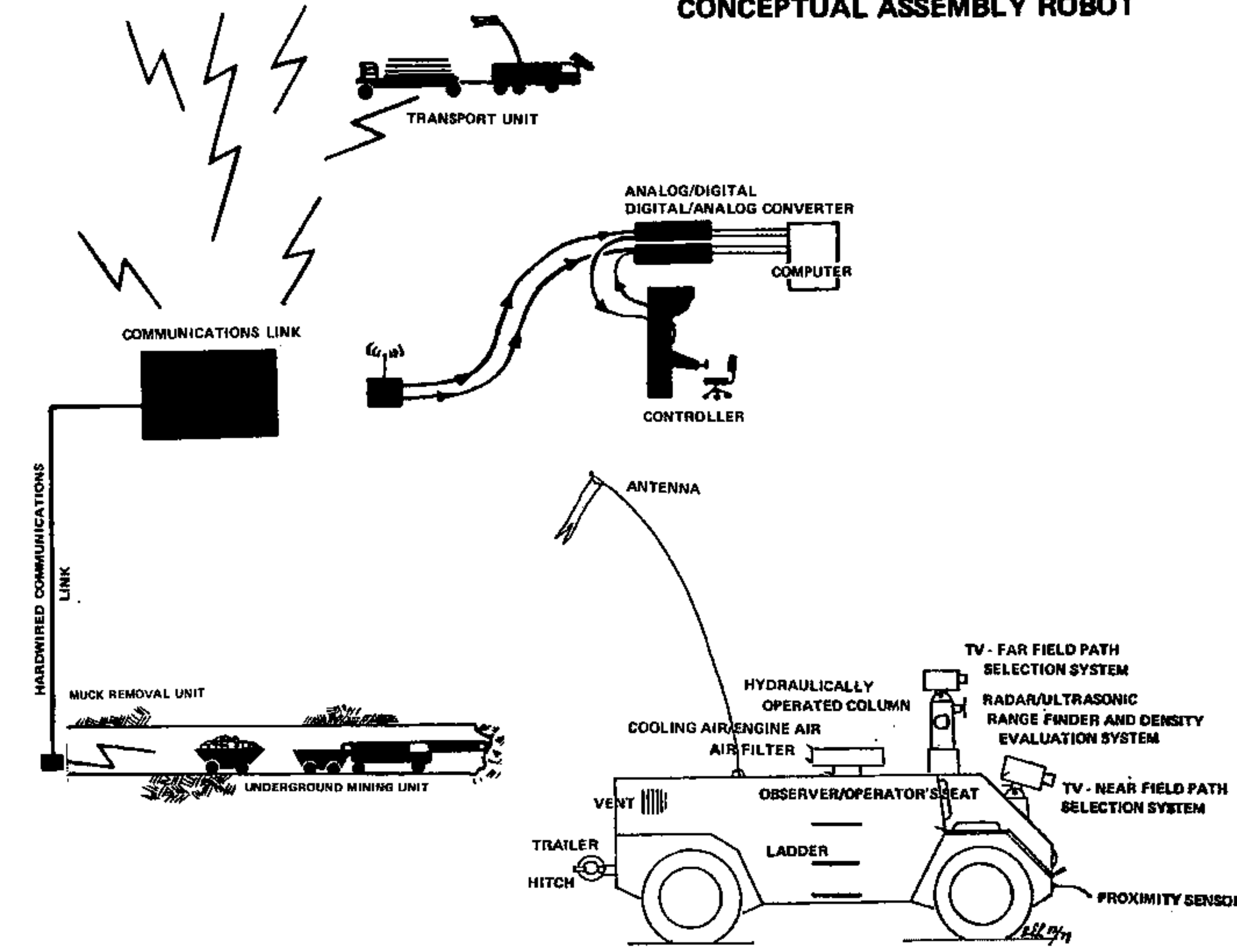

TRANSPORT UNIT WITHOUT MANIPULATOR

RECTENNA SYSTEM DESIGN

W. C. Brown - Raytheon Company

R. M. Dickinson - NASA/JPL

E. J. Nalos - Boeing Aerospace Company

J. H. Ott - Novar Electronics Corporation

The function of the rectenna in the solar power satellite system is to convert the downcoming microwave power beam to electrical grid power. Due to its large physical size (a typical rectenna site is a 10 KM x 14 KM ellipse) and element composition (over 10^9 diode assemblies), the projected cost savings of automatic mass production are of prime importance. The fundamental processes at the rectenna consist of rectifying the incident r.f. field into d.c. current using Schottky barrier diodes, filtering the rectified output, combining it and processing it to higher voltages for distribution. Hierarchical combination and processing of currents is done several times to integrate the relatively low power per diode to electrical grid power magnitudes.

Figure 1 illustrates the basic design choices based on the desired microwave field concentration and ground clearance requirements. The current design utilizes a non-concentrating inclined planar panel with a 2 meter minimum clearance.

The receiving element options are summarized in Figure 2. Dipoles in various implementations represent the most straightforward way of receiving a linearly polarized incident field compatible with the slotted waveguide transmitting array. The modified half-wave dipole in Figure 2 has been selected in the baseline. Higher gain per element options, however, are worthy of further study. The baselined modified half-wave dipole, with a capture area of 70 CM^2 (typical) will provide between 1-2 watts of power per diode at the center of the rectenna (23 mW/CM^2) indicating good efficiency. Dipole arrays are used near the rectenna periphery to maintain rectification efficiency. The design chosen integrates the dipoles and their associated power and microwave circuitry inside an aluminum environmental shield and support structure which readily lend themselves to mass production methods. The dipole assembly also contains a filtering and matching circuit. The number of dipoles in the rectenna is approximately 1.3×10^{10} .

To effectively match the incident power flux to the diode rectifiers, a ten ring design has been adopted (Figure 3). Antenna elements are formed by using the basic dipoles in arrays containing 2, 4, or 8 dipoles. The array assemblies are combined into 7,060,224 panels, each $3\text{M} \times 3.33\text{M}$, which are the smallest assembly units from the fabrication point of view. There are four different types of panels, corresponding to the four different types of receiving arrays. Units are combined from panels in such a manner that nominally 1,000 panels are in one unit. The last assembly which is formed at DC is called "group" (5-10 MW of power). The DC to AC inverters are located at the group centers with 70 MW of power, typically.

The rectenna AC system is shown in Figure 4. The 40 MW converter station output is transmitted by underground cable to 200 MW transformer stations where the voltage is stepped up to 230 kV, then collected in 1,000 MW groups and transformed to 500 kV for interphase with the bulk transmission system. The switchyards are shown arranged as reliable "breaker and a half" schemes where single contingency outages may be sustained without loss of power output capability. Availability calculations for the baseline rectenna design indicate that 80% of the rated satellite power is available 96.8% of the time, and that scheduled no-power periods total only 208 hours per year. For

distances of 400 miles or more, consideration should be given to high-voltage DC (HVDC) since it can be used to improve the stability of the AC system to which it is connected.

One important area of concern from the EMI point of view is harmonic re-radiation and scattering from the rectenna. There are enough scattering mechanisms for harmonics from the diode rectifier and associated noise to warrant the question of meeting current requirements. In the baseline design, two low pass filter sections which attenuate the second and higher order harmonics by over 25 dB are used. More filter sections add approximately 17 dB more suppression, each at a cost of approximately 1% efficiency loss. Other alternatives, also with an efficiency penalty, are to use stub line filters or full wave rectification. All of these approaches have mechanical configuration problems that, while solvable, will increase rectenna diode array assembly costs. These will be subjects of further SPS investigation. Scattering losses due to Fresnel edge diffraction are estimated at between 1 to 2%.

Optimization of a rectenna system design to minimize costs is carried out at several levels. The rectenna size is determined by the point where the incremental rate of return from sales of the intercepted power are marginal. Much of the cost of the rectenna is in the structural support material required to support it against wind drag and snow loads. The present rectenna panel support structure evolved from stiff edge-supported panels to a hierarchical more centrally supported frame which uses much less material. Construction of the rectenna is, by necessity, highly automated. Starting with prefabricated dipole assembly components, a dipole machine manufactures complete dipole/diode assemblies at a high rate. These are then combined with other prefabricated parts to manufacture receiving element sticks. The sticks, metal frame and ground plane are then tack-welded together to form panels. The completed panels are then taken to the rectenna site where specialized equipment prepared the site through the emplacement of panel support arches. The panels are then lowered on the support arches, fastened and connected electrically. The rectenna cost breakdown is indicated below for a 5 GW installation:

Land (47,800 acres at \$2,500/acre)	\$120M
Structures and Installation	\$346M
RF Assemblies and Ground Plane	\$959M
Distribution Busses	\$308M
Command and Control Center	\$70M
Power Processing and Grid Interface	<u>\$775M</u>
TOTAL	\$2,578M

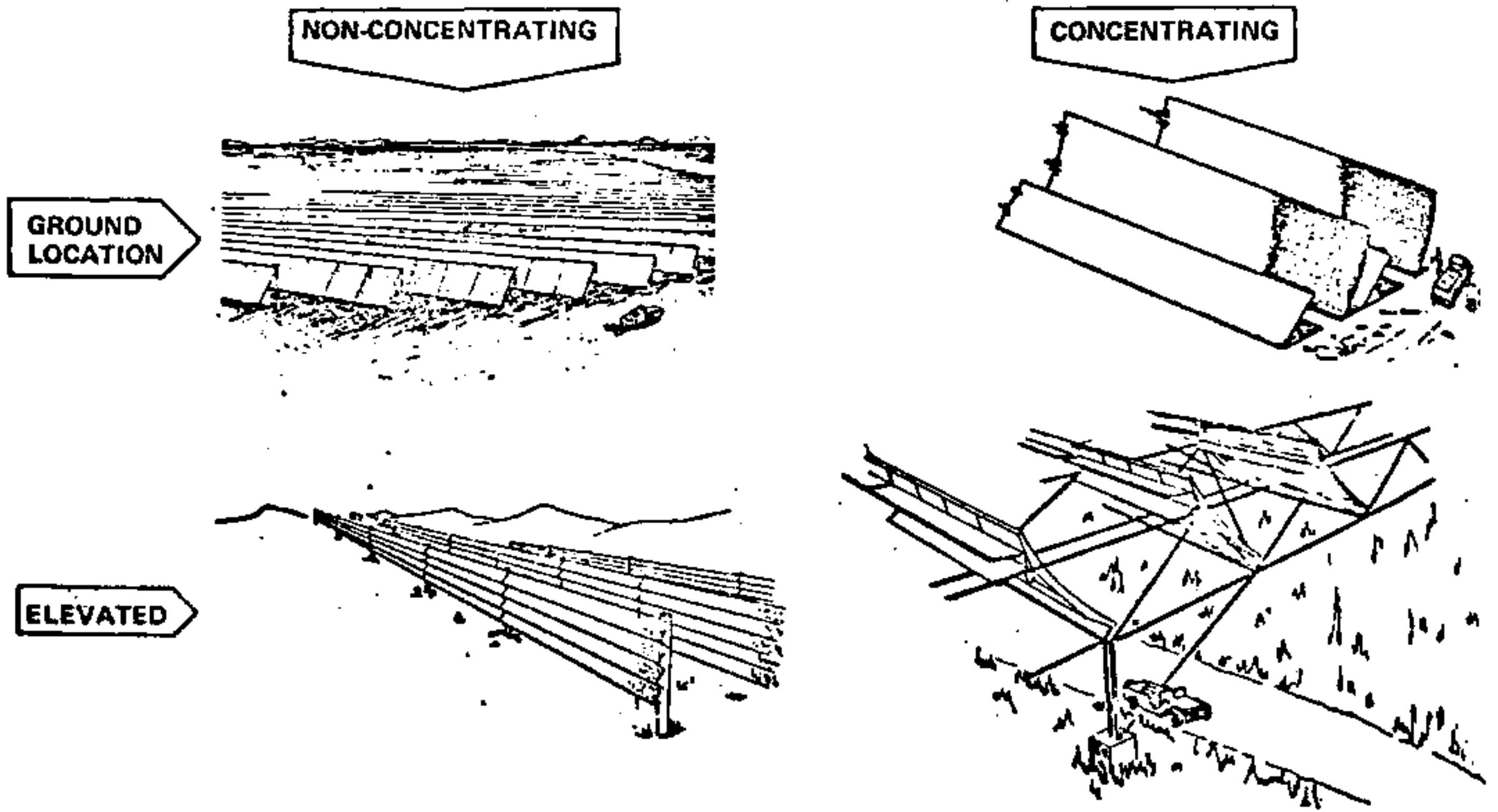

Figure 1: Potential Rectenna Configurations.

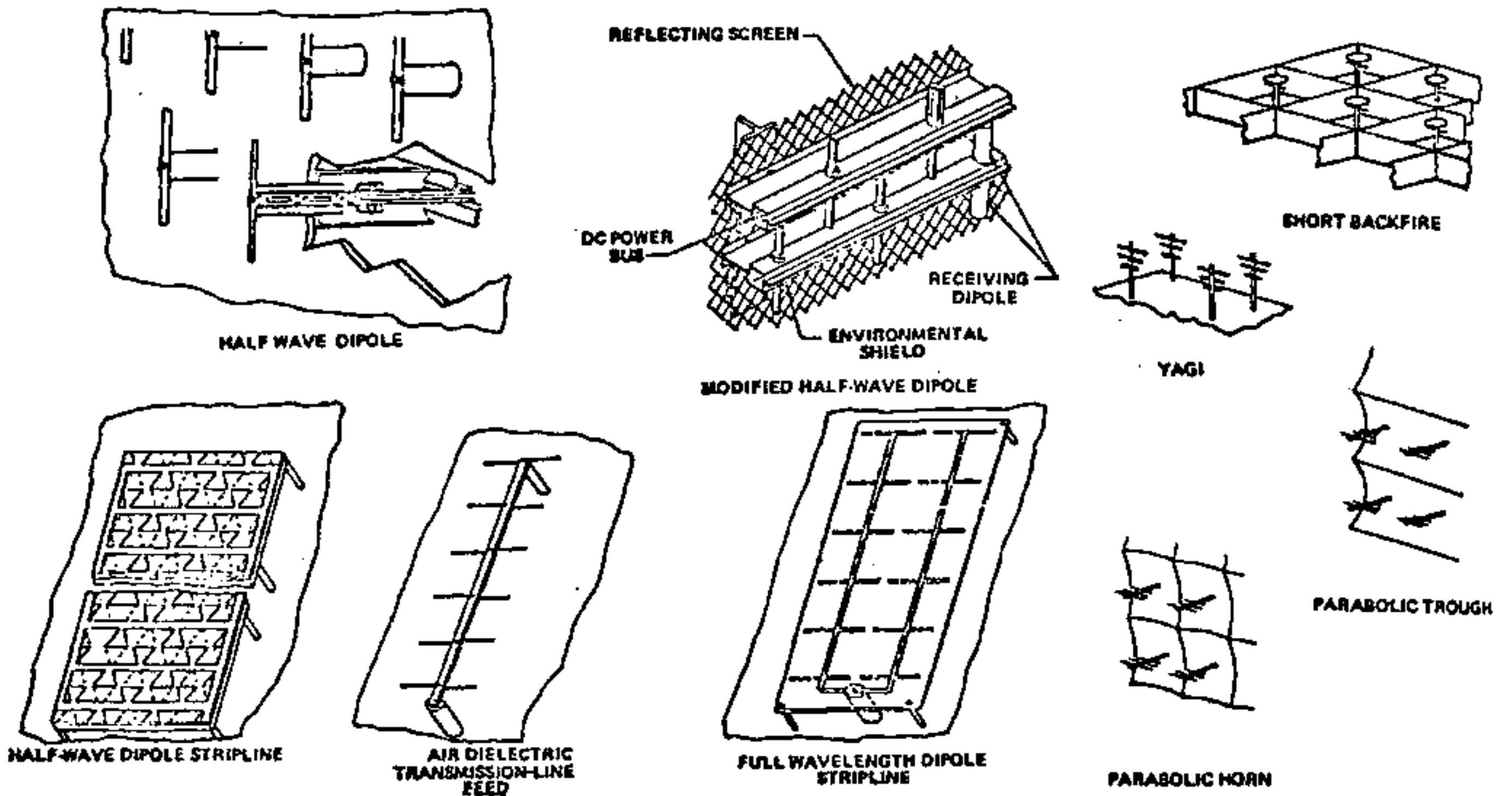

Figure 2: Rectenna Receiving Element Options

FIGURE 3: RECTENNA RING AND UNIT BOUNDARY MAP

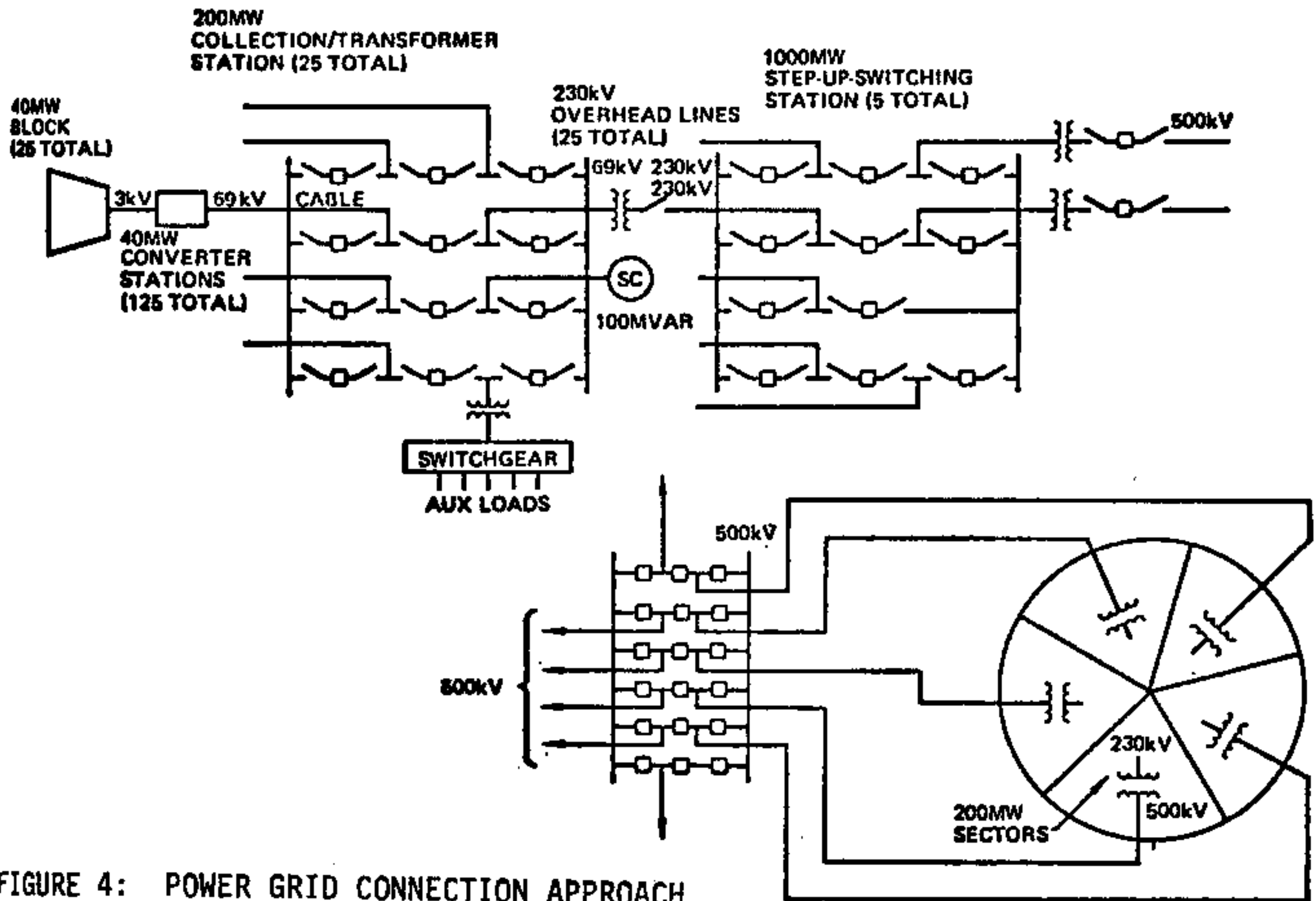
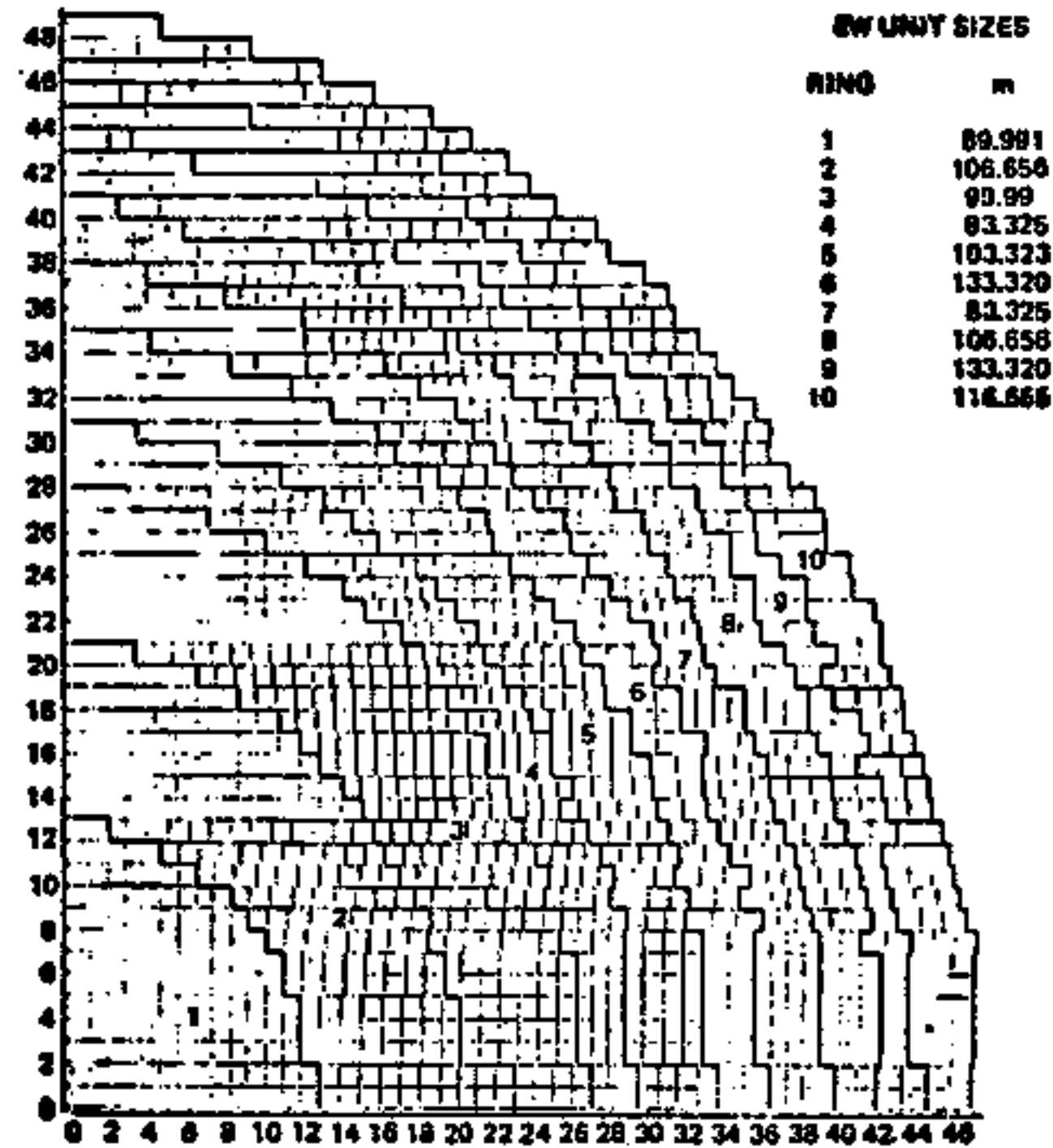

FIGURE 4: POWER GRID CONNECTION APPROACH

A THEORETICAL STUDY OF MICROWAVE BEAM ABSORPTION BY A RECTENNA
James H. Ott - James S. Rice - Donald C. Thorn
Novar Electronics Corporation - Barberton, Ohio

Power Beam Absorption

The Rectenna's microwave power beam absorption limit is theoretically confirmed to be 100%. Two mathematical models descriptive of the microwave absorption process were derived from Maxwell's equations. The first model is based on the current sheet equivalency of a large planar array above a reflector. The model is characterized by a mathematical expression for the fraction of an incident plane wave's power that is reflected from the sheet.

The second model, which is based on the properties of a waveguide with special imaging characteristics, quantifies the electromagnetic modes (field configurations) in the immediate vicinity of a Rectenna element in the Rectenna array. This model then gives the limits for element spacing which permit total power beam absorption by preventing unwanted modes from propagating (scattering).

Rectenna Design Improvements

Several improvements in the Rectenna design have been indicated by the mathematical modeling.

1. A significant reduction can be made in the density of the Rectenna elements needed for total beam absorption. This would not only significantly reduce the cost of the Rectenna but also indicates greater diode efficiency because of the higher power density per diode.
2. The Rectenna panels can be made to totally absorb at any angle of incidence by adjusting reflector and element spacing and load impedance as seen by the dipole elements. This suggests a flat or terrain conforming Rectenna eliminating the need for the "billboard" or "Venetian blind" design and essentially conforming to the terrain.
3. The screen reflector should be able to be replaced by parasitic reflector dipole elements.

Scattering

Specular scattering of the power beam at the power beam fundamental frequency is expected to result from most deviations in the Rectenna parameters. The properties of this scattering, including the modeling-determined scattering losses due to variations in several parameters from design center values required for total absorption at normal incidence, are shown in Figure 1.

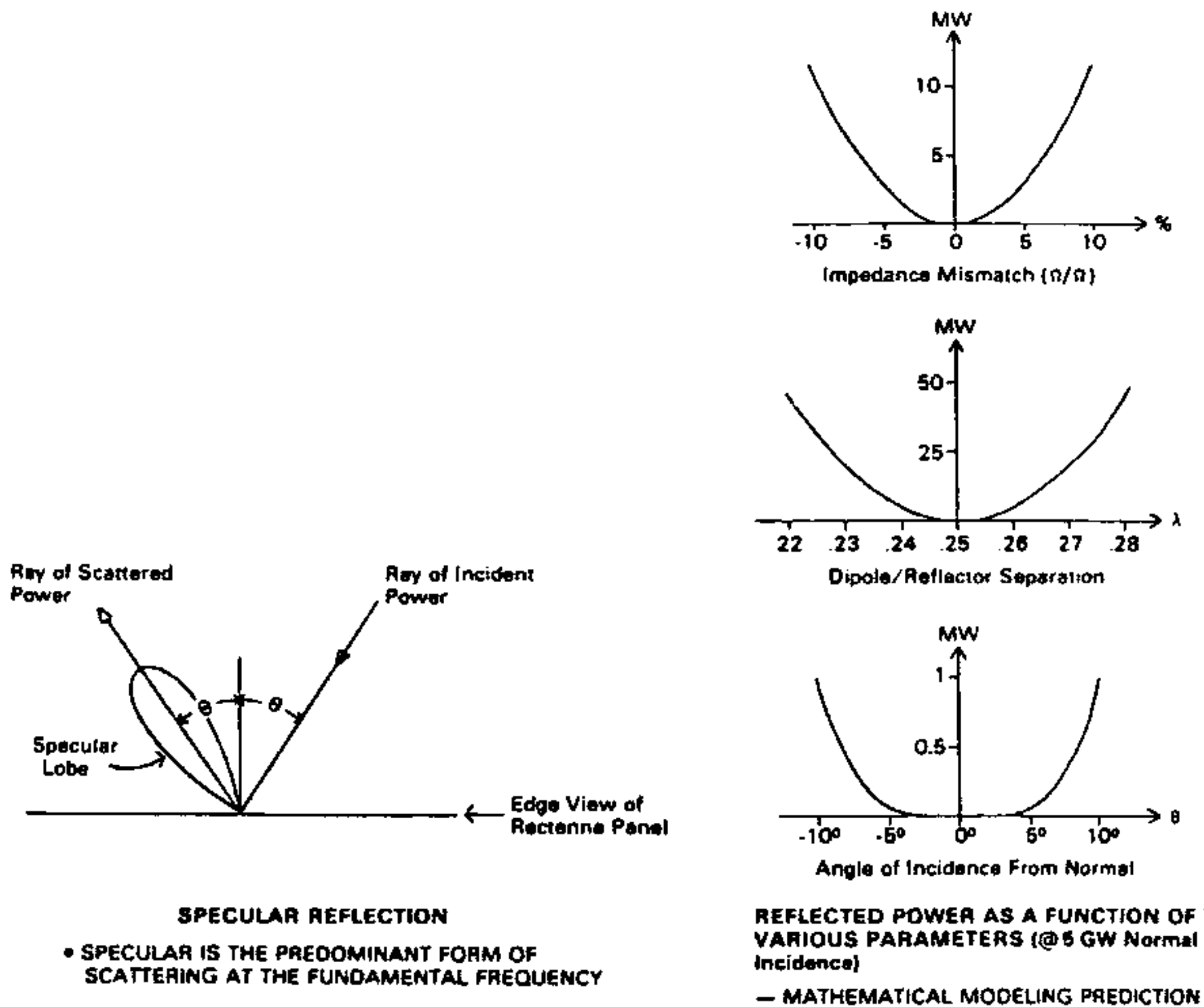
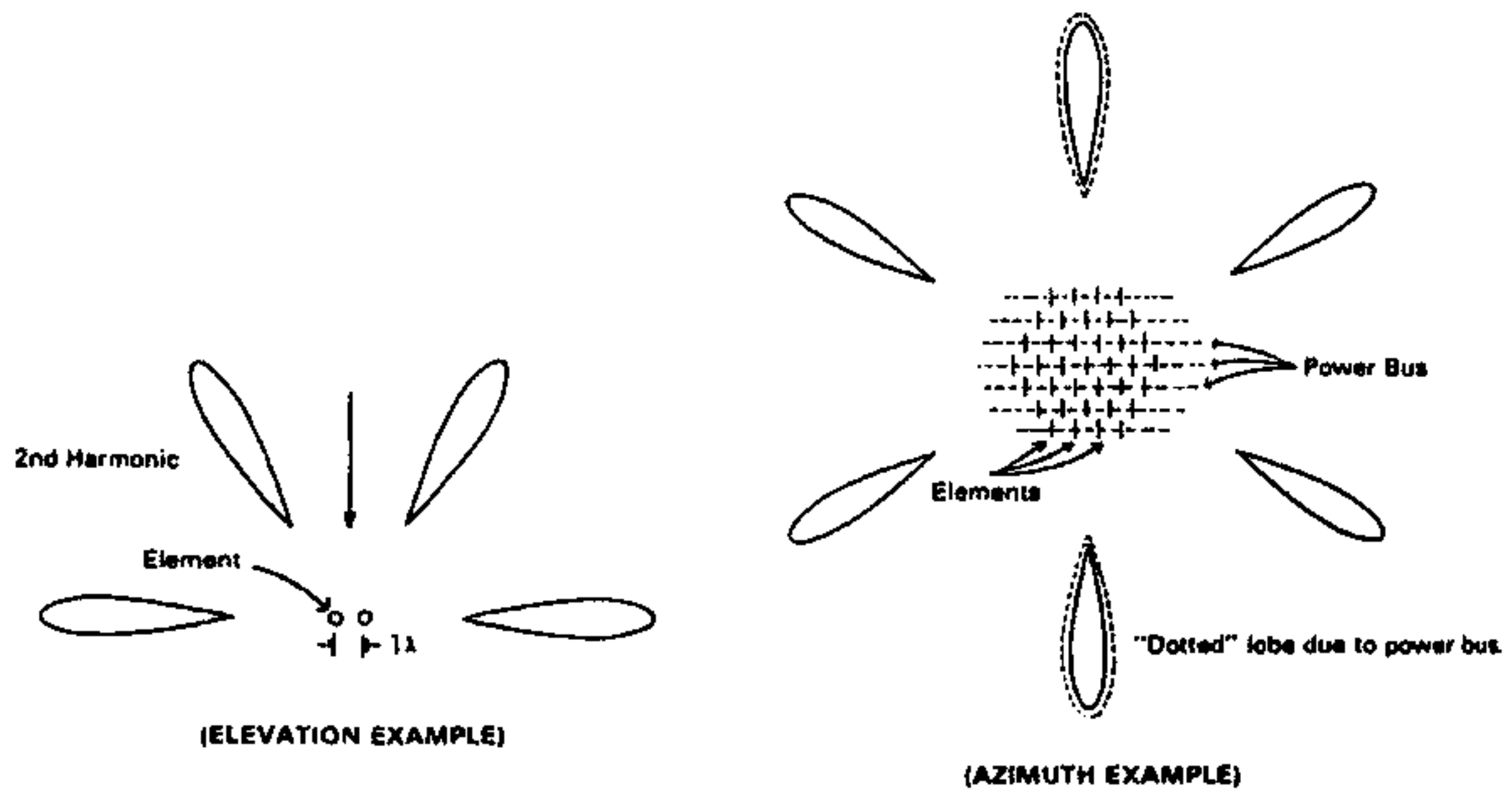

FIGURE 1

PROPERTIES OF SCATTERING FROM RECTENNA
AT FUNDAMENTAL FREQUENCY OF POWER BEAM

The Rectenna dipole-filter-diode assembly and power bus are expected to be the significant sources of harmonic radiation. The harmonic energy will be concentrated in calculable grating lobes, as shown in Figure 2.



- DIRECTIONAL CHARACTERISTICS OF HARMONIC SCATTERING FROM A RECTENNA CAN BE DETERMINED BY GRATING LOBE ANALYSIS, WITH THE RECTENNA RECEIVING ELEMENTS, POWER BUS, AND OTHER RECTENNA COMPONENTS AS RADIATORS.

FIGURE 2

EXAMPLES OF DIRECTIONAL CHARACTERISTICS OF SCATTERING FROM RECTENNA AT HARMONICS OF POWER BEAM FREQUENCY

A large object flying through the power beam over the Rectenna causes diffraction patterns to be generated at the Rectenna, as depicted in Figure 3. Therefore, Rectenna diodes should have tolerance to the resulting overvoltage and thermal transients.

Among the factors causing scattering are microwave beam depolarization and amplitude fluctuations caused by disturbances in the atmosphere. Depolarization is not expected to be a significant source of scatter. Amplitude fluctuations cause scattering by disrupting the uniformity of the Rectenna illumination. In addition, this disruption of the RF power level from design values for the diodes causes impedance mismatches resulting in further scattering.

• RECTENNA DIODES SHOULD HAVE TOLERANCE TO:

- Overvoltage transients
 - Fast aircraft
- Thermal transients
 - Slower objects (e.g. helicopters)

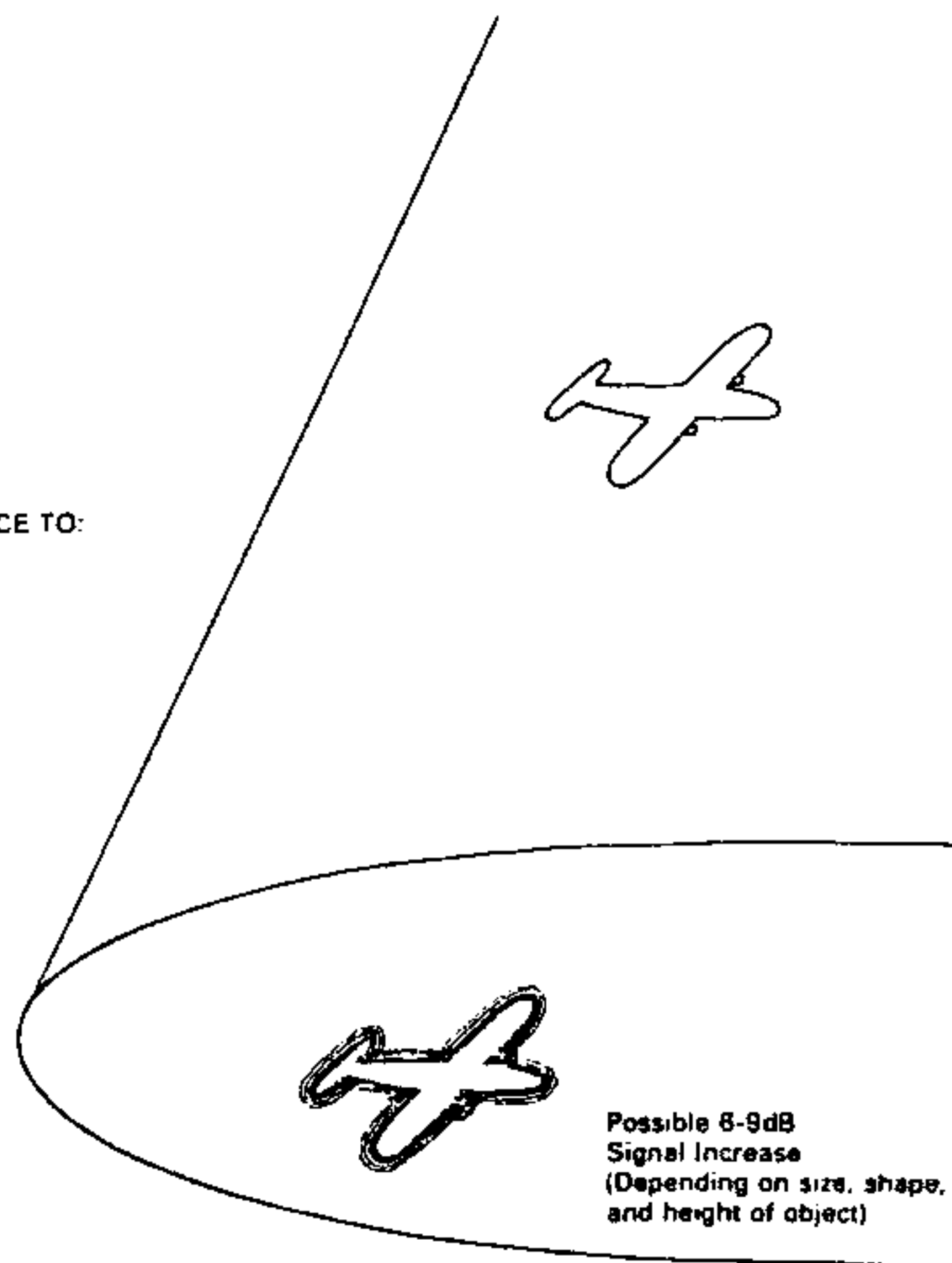

FIGURE 3

DIFFRACTED SIGNAL ENHANCEMENT AT THE RECTENNA CAN BE CAUSED BY AN OBJECT FLYING THROUGH THE POWER BEAM.

Although existing earth-space propagation measurements to date have indicated that amplitude fluctuations would cause insignificant scattering at a Rectenna, there are two factors which impair the application of this data to a Satellite Power System (SPS). In all studies found, there is significant aperture averaging due to the large aperture receiving antennas used. This is in contrast to the very small aperture area of each "independent" receiving element in the Rectenna. The second factor is that the signals measured in those studies were wide-band. Most deep fades are frequency selective. Therefore, observed amplitude fluctuations would be expected to be less than those of the monochromatic SPS power beam. Thus, further space-earth transmissions studies are proposed.

POWER AMPLIFIERS (TUBE)

William C. Brown, Raytheon Company, Waltham, Massachusetts 02154

The microwave tube devices that have been proposed to meet the SPS transmitter requirements of very high efficiency, low mass, long life, high temperature operation, and low radio frequency interference are the klystron, magnetron, amplatron, and two new devices, the gyrotron and the photoklystron. The klystron and the magnetron in its directional amplifier form are the furthest advanced and have received the most attention. The klystron approach proposes a 70 kilowatt design with depressed collectors and recycled DC power for high efficiency and a heat pipe system to radiate the heat. The magnetron directional amplifier approach proposes an efficient 3-5 kilowatt tube scaled from the microwave oven magnetron and an attached radiator made from pyrographite to passively radiate heat.

The operating principles of the klystron and the crossed field device in either its magnetron or amplatron configuration are shown in Figure 1. In the klystron the energy of the power supply is converted into kinetic energy of the electron stream. The electron stream is then velocity modulated so that the electrons bunch together. These bunches are then abruptly slowed as they pass through the output cavity and most of their energy is converted into microwave energy. The left over energy may be partially extracted in the form of DC power from a series of depressed collectors. The DC power is reprocessed and added to the power feeding from the power supply.

The crossed field device works on a different principle in that the electrons are just given a small amount of kinetic energy to become synchronous with the microwave circuit. From that time on there is a direct conversion of the potential energy of the power supply into microwave energy.

The microwave generator's ability to operate efficiently and to dispose of waste heat by operating at a high temperature dominate the design of the microwave transmitter. Figure 2 shows the amount of microwave power that can be radiated per unit area as a function of the efficiency and operating temperatures of the tube, and indicates the comparative capability of crossed field generators, klystrons, and solid state devices.

The maximum efficiency that has been achieved from a klystron is 75% while the efficiency that has been achieved by both magnetrons and amplatrons is in the 83 to 85% range. Top efficiency from a klystron after a substantial development program is expected to be 85%. A similar effort could increase the crossed field device efficiency to 90%.

Because this symposium places emphasis upon recent technology developments much of the remainder of this extended abstract will review an ongoing investigation of a power scaled version of the microwave oven magnetron as a potential generator for the SPS.

A principle item of interest is the noise measurements that have recently been made on the common microwave oven magnetron. Making use of a special measuring technique in which a high-power, narrow-band notch filter rejects all but one part in 100,000 of the carrier signal to permit a spectrum analyzer to be exposed to the full level of the noise output, signal to noise ratios of 180 to 190 dB/Hz in selected tubes have been measured. The measurement sensitivity is still limited at frequencies outside of a 60 MHz band centered on 2450 MHz by the residual noise level of the spectrum analyzer. To place these measurements in perspective, such high ratios means that an 8 gigawatt SPS transmitter would radiate less than 2.5 milliwatts of noise for each megacycle of the frequency spectrum.

POWER AMPLIFIERS (TUBE)

Difficult-to-make harmonic measurements have been obtained on the magnetron with two different measurement techniques. Jet Propulsion Lab. measurements indicated -55 dB, -65 dB, and -68 dB for the 2nd, 3rd, and 4th harmonics, while the Raytheon measurements indicated -71 dB, -85 dB, and -86 dB. These levels are lower than those expected for klystrons but are still orders of magnitude above what would be acceptable without making special frequency allocations for these harmonics or making extensive use of filters which would badly compromise efficiency and mass of the SPS.

To develop an experimental model of the SPS transmitting antenna architecture the microwave oven magnetron has been combined with a ferrite circulator, a section of slotted waveguide radiator, and a control system to force the amplitude and the phase of the radiated output to follow phase and amplitude references. The amplitude control arrangement is shown in Figure 3.

The amplitude reference is set and the amplitude of the output is maintained to within $\pm 4\%$ of the reference over the voltage and current operating range of the magnetron directional amplifier as indicated by the data of Figure 4. Figure 4 also shows how the amplitude control feature can be used to accommodate the tube to large variations in the characteristics of the solar cell array. In this context the amplitude control feature could replace much of the complex power conditioning associated with changing from one DC voltage to another at high power levels that would otherwise be necessary.

Similarly, the phase of the radiated power as measured by a probe placed in front of the slotted waveguide radiator is controlled to within ± 1 degree of the reference over the operating range of the magnetron directional amplifier.

The amplitude and phase control has been achieved with solid state circuitry. The mass and cost of these devices is acceptable to the SPS but special arrangements must be made to keep them at an ambient temperature below 125°C by mounting them on the slotted waveguide radiator and using it as a heat sink as necessary. Thermal separation of the waveguide radiators from the microwave generators is accomplished by a blanket of insulation.

Special problems still remain in a transition from the experimental system just reviewed and application to the SPS. The ferrite materials in the circulator are not suitable for high temperature operation in space. A "Magic T" arrangement is an alternative but a design in which phase and amplitude control are maintained without placing solid state sensors in a high temperature environment has not been experimentally verified. Similarly the motor driven coaxial phase shifter which was used to correct for phase shift through the tube to maintain the reference phase at the output is probably not acceptable for space use.

Long life is an important requirement imposed upon the generator in the SPS. Magnetrons that are expressly designed for the SPS are expected to have a very long life. Such expectations are supported by optical measurements of low cathode operating temperature in the microwave oven magnetron. At the 400 watt microwave output level these temperatures are sufficiently low to indicate lifetimes of tens of years. In scaling to the SPS requirements, tube designs with potential lifetimes of fifty or more years can be expected.

POWER AMPLIFIERS (TUBE)

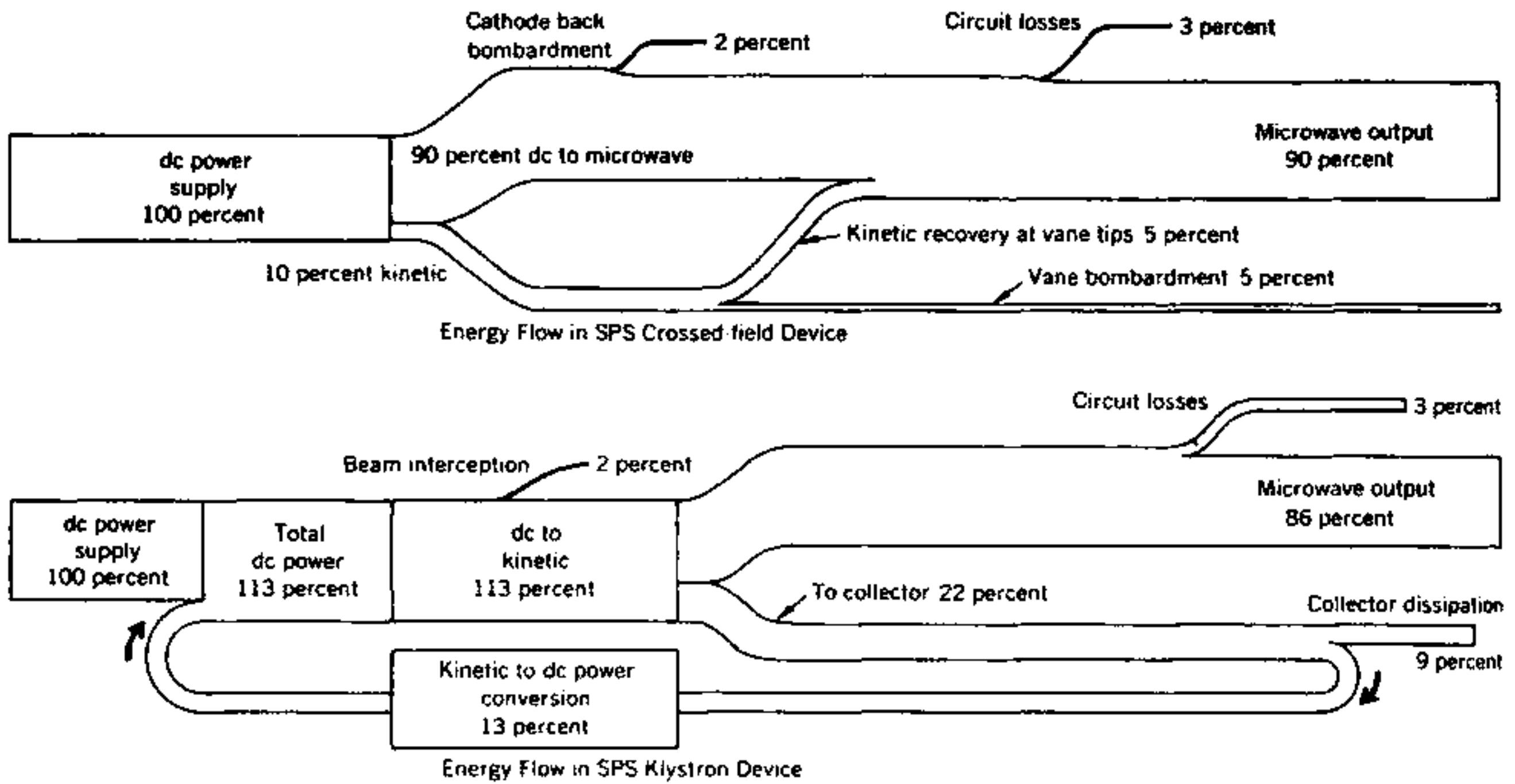

Figure 1. Comparison of DC-RF Conversion Operations for Crossed-Field (Top) and Linear-Field (Bottom) Beam Devices.

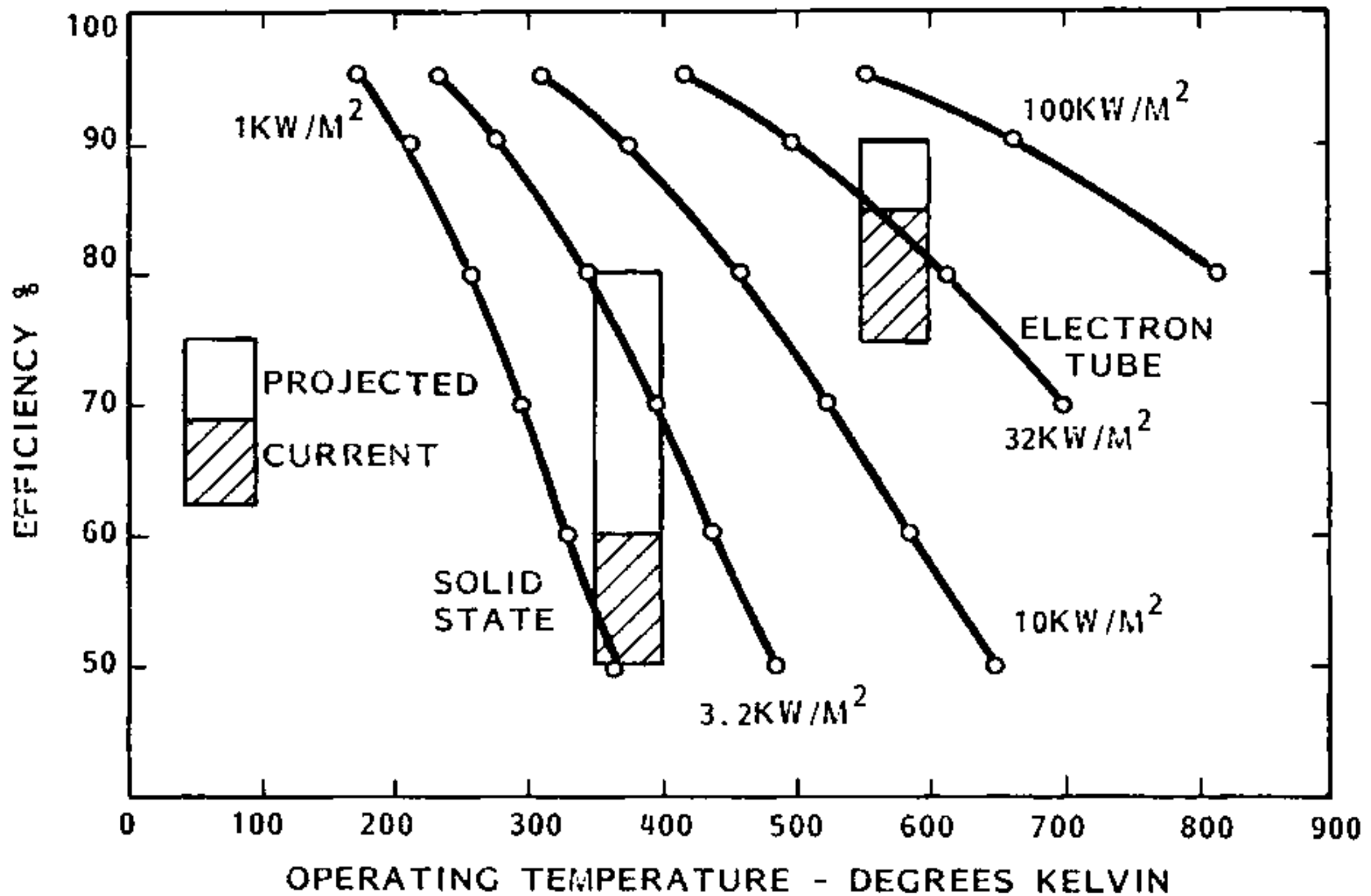

Figure 2. Contours of Microwave Power Outputs as Function of Efficiency and Operating Temperature of Microwave Generators. 813693

POWER AMPLIFIERS (TUBE)

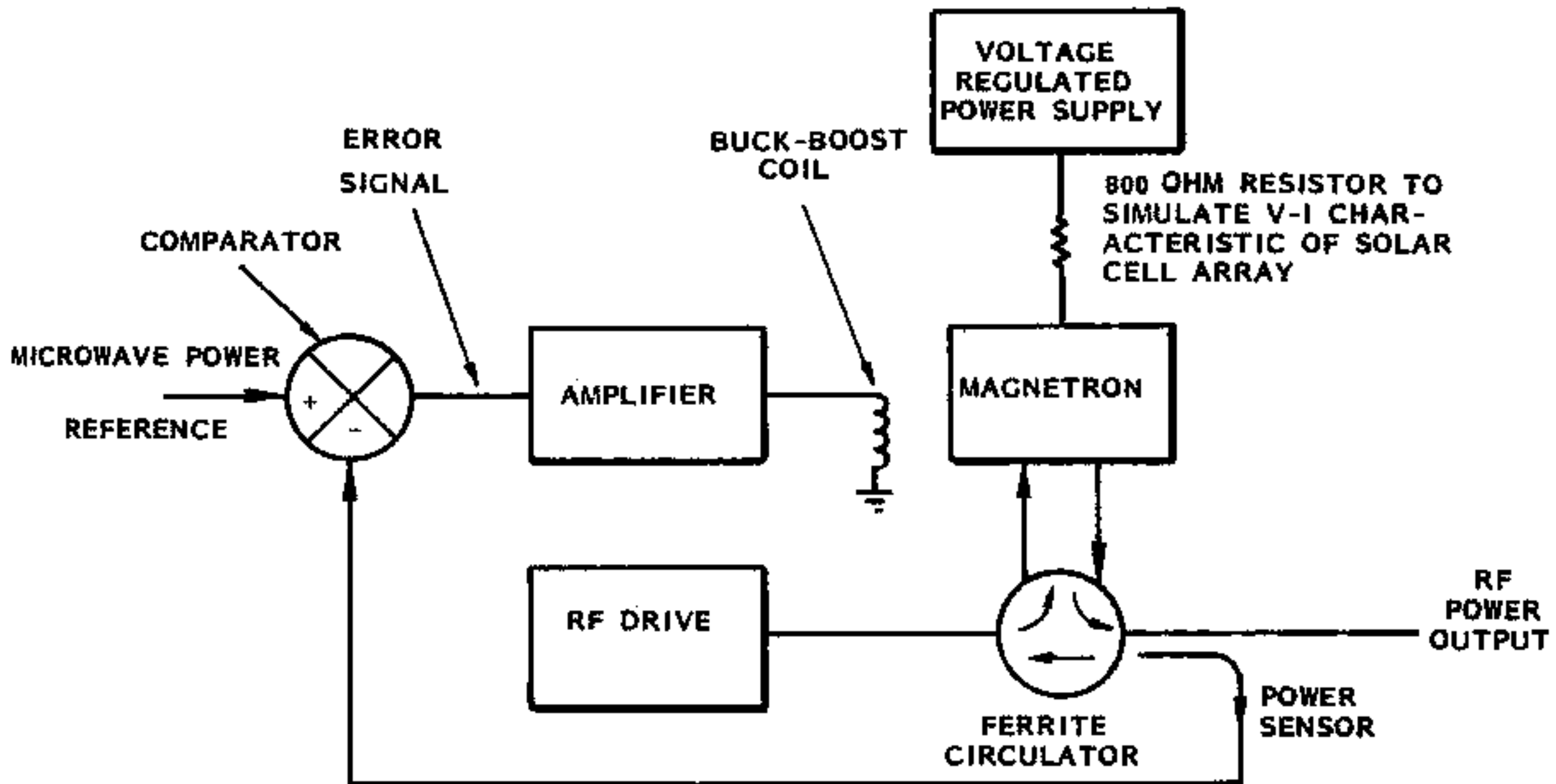

Figure 3. Test Arrangement for Evaluation of Amplitude Control.

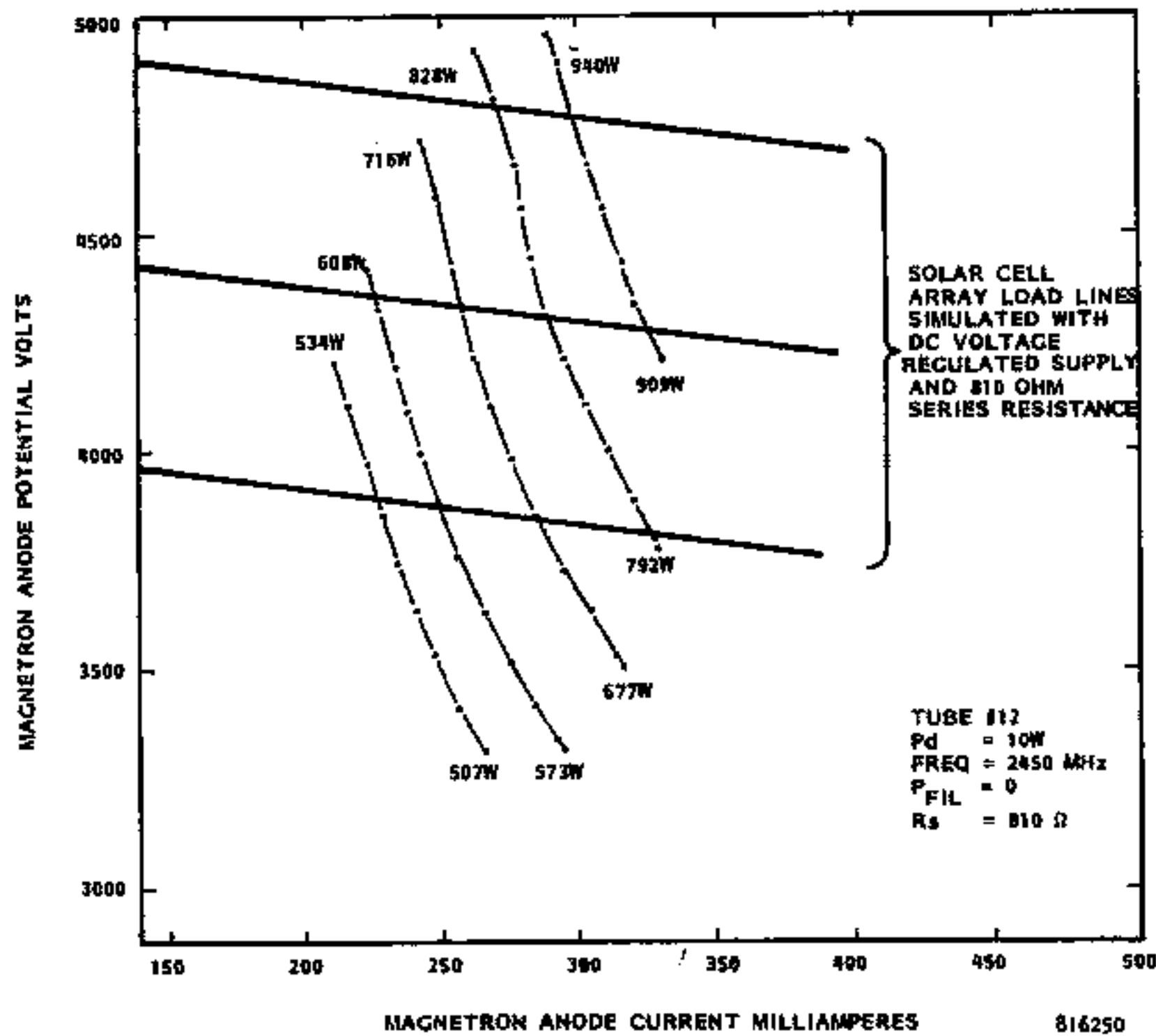

Figure 4. Experimental Data Showing Five Amplitude Tracking Curves Corresponding to Five Different Settings of the Power Reference.

SOLID-STATE CONFIGURATIONS
K. G. Schroeder
Rockwell International - Anaheim, California

INTRODUCTION

This paper describes two prototype solid-state phased array systems concepts developed by Rockwell for the Solar Power Satellite (SPS). In both concepts, the beam is centered on the rectenna by means of phase conjugation of a pilot signal emanating from the ground. Also discussed are solid-state studies performed at Boeing and Raytheon.

The basic Rockwell concepts are now described in more detail.

OVERVIEW OF SOLID-STATE ARRAY CONCEPTS

Two different solid-state arrays are being developed at this time: The End-Mounted Space System (Figure 1) and the Sandwich (Figure 2). Both concepts use the same element (a dipole) and spacing, but in the end-mounted system 36-watt amplifiers are mounted on the ground-plane, whereas in the sandwich the amplifiers are elevated to the dipoles, and their waste heat is dissipated by beryllium oxide discs. The feed lines are underneath the ground-plane, and a coaxial transmission line is carried all the way to the amplifier input. (See section on RF Signal Distribution).

REFERENCE PHASE DISTRIBUTION

Phase conjugation at the 5 meter by 5 meter subarray is used to steer the beam. The reference phase signal is distributed over the spacenna aperture via a radio link. Figure 3 illustrates this method giving a perspective view of the top of the aperture. Two important features are: (a) the phase reference signal originates from a single transmit location at the rear of the aperture; and (b) phase reference and pilot antennas are orthogonally polarized with respect to the power dipoles to avoid feedback loops. Instead of an endfire (e.g., "Cigar") array, broadside arrays can be used for reference and pilot pick-up. Both configurations shall be considered in more detail in future studies.

The phase reference signal is distributed as follows:

From the shaped-beam illuminator antenna an RF signal is distributed over a cone with maximally 90 degrees beamwidth. All reference pick-up antennas see approximately the same signal strength. The local oscillator and driver amplifier is redundant. Large variations in aperture flatness can be compensated modulo 2π since bandwidth is of no concern for the reference phase signal. The phase at each subarray pick-up point is normalized with respect to a perfectly flat uniform aperture by means of a servo loop shown in Figure 4. For each subarray center location, a phase delay differential ("reference standard") is computed which occurs for the two generating frequencies f_{R1} and f_{R2} if the receiving antenna is located on a perfect plane. These delays can be calculated, and tuned in the lab to fractions of a degree. The output of the phase bridge then drives a phase shifter until the path delay differential equals that of the reference standard.

Since this circuit is used at every subarray, the subarray center points are electrically normalized to show $\phi = \phi_0$ constant across the entire array. This provides the conjugation circuit with the required reference phase.

RETRODIRECTIVE BEAM CONTROL

A retrodirective control circuit which compensates for pilot-generated beam shifts (without ionospheric effects) is the Chernoff circuit, with additional isolation added by (a) separating the pilot and power frequency paths, (b) using orthogonally polarized radiating elements; and (c) providing the remaining isolation in separate bandpass filters. The total required filter isolation is 70 dB, according to preliminary pilot system calculations.

This pilot system is predicated on ~ 100 dBw pilot power. The proposed implementation of this pilot system consists of a circular array of low to medium-gain elements placed at the periphery of the rectenna, on top of utility poles if necessary to avoid interference from the power collection and transmission system.

The system provides vastly improved reliability over a single-dish, concentrated amplifier pilot system, and also provides such a wide power tube when the near-field beam enters the ionosphere that certain ionospheric effects will be mitigated. If ionospheric tests show that delay compensation through the ionosphere is required, a three-tone pilot system will be used.

RF SIGNAL DISTRIBUTION SYSTEM

The current baseline distribution system for the conjugated RF signal is the same for both solid-state concepts.

Six "levels" of 4-way corporate divisions provide equiphase feeding to the 4,096 elements in each 5m x 5m subarray. The network is contained in one plane.

The salient features of this distribution network are: weight of 0.67 million kilograms for the total array using UT-47M; 250°C temperature capability; approximately 7 dB ohmic loss (in addition to 36dB splitting loss). All layers of coax are pressed together behind the ground-plane, and very little thermal resistance is presented to the heat being radiated rearward from the ground-plane in the end-mounted concept, and toward the ground-plane (from the solar cells) in the sandwich concept. The composite heat transfer will be established by the spacing between the ground plane and the solar cells in the case of the sandwich.

An alternate approach uses stripline distribution underneath the groundplane. The advantage is better manufacturability but the ohmic loss is ~ 20 dB higher, requiring more amplification.

FIGURE END-MOUNTED SOLID-STATE CONFIGURATION

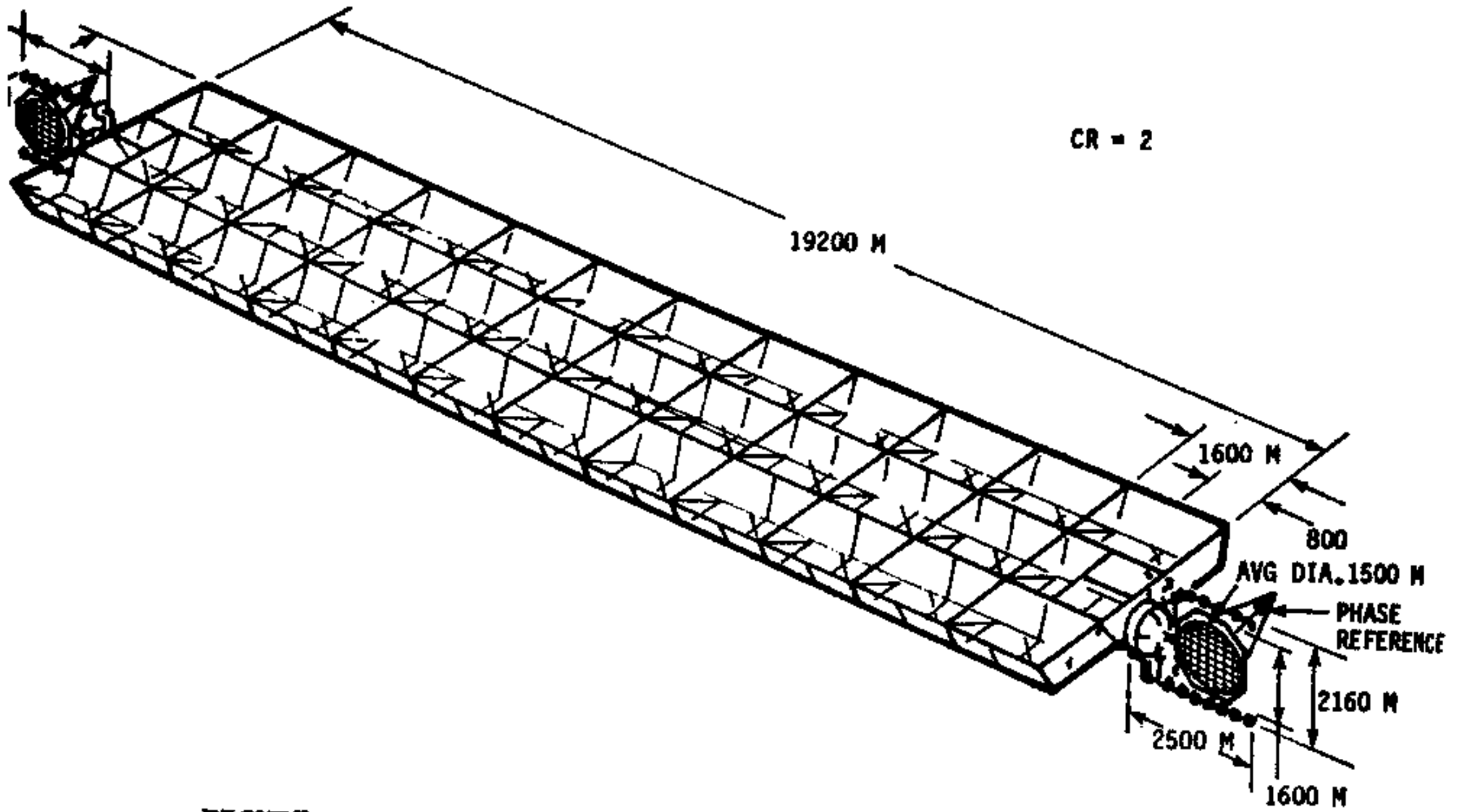

FIGURE SANDWICH CONFIGURATION

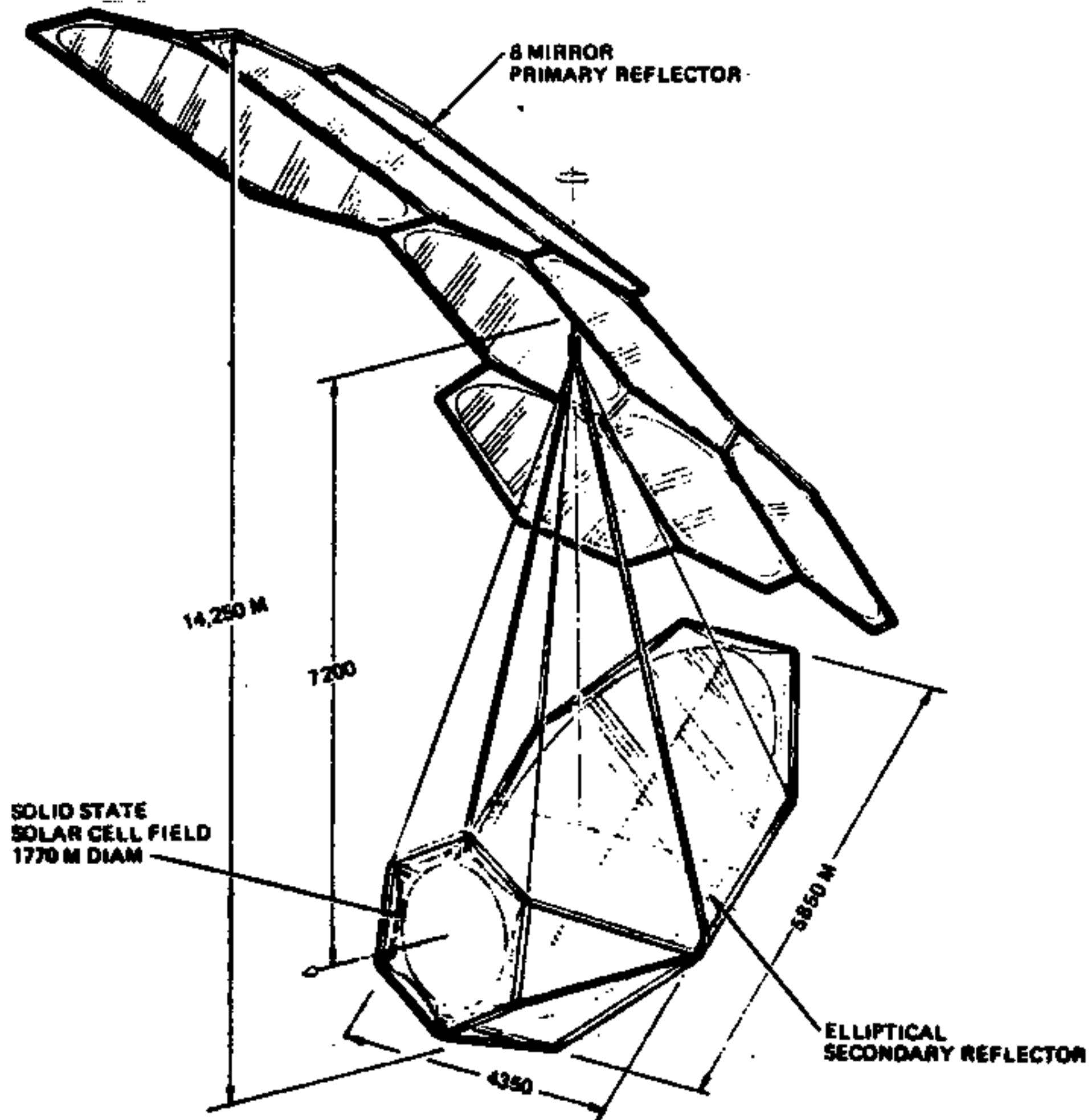
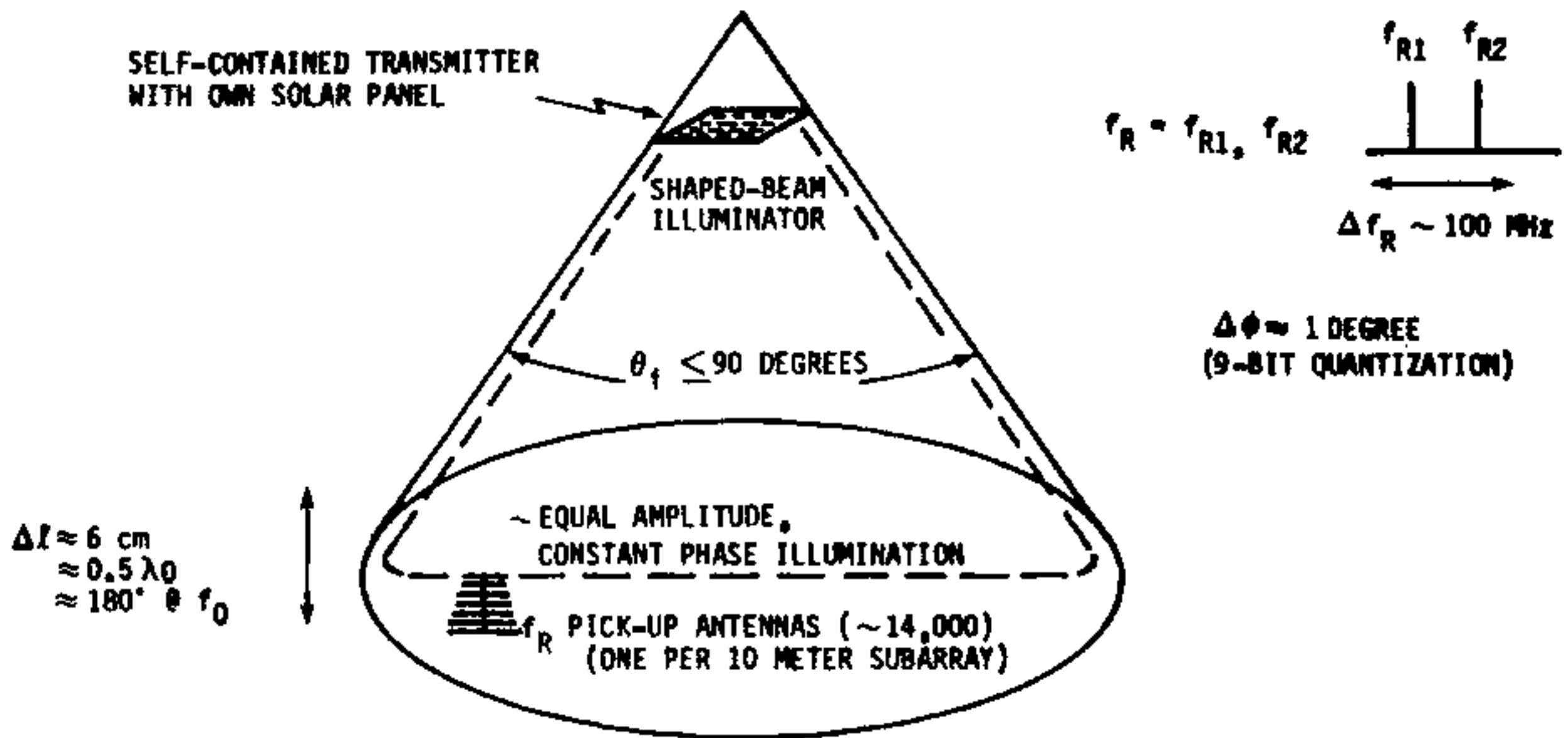
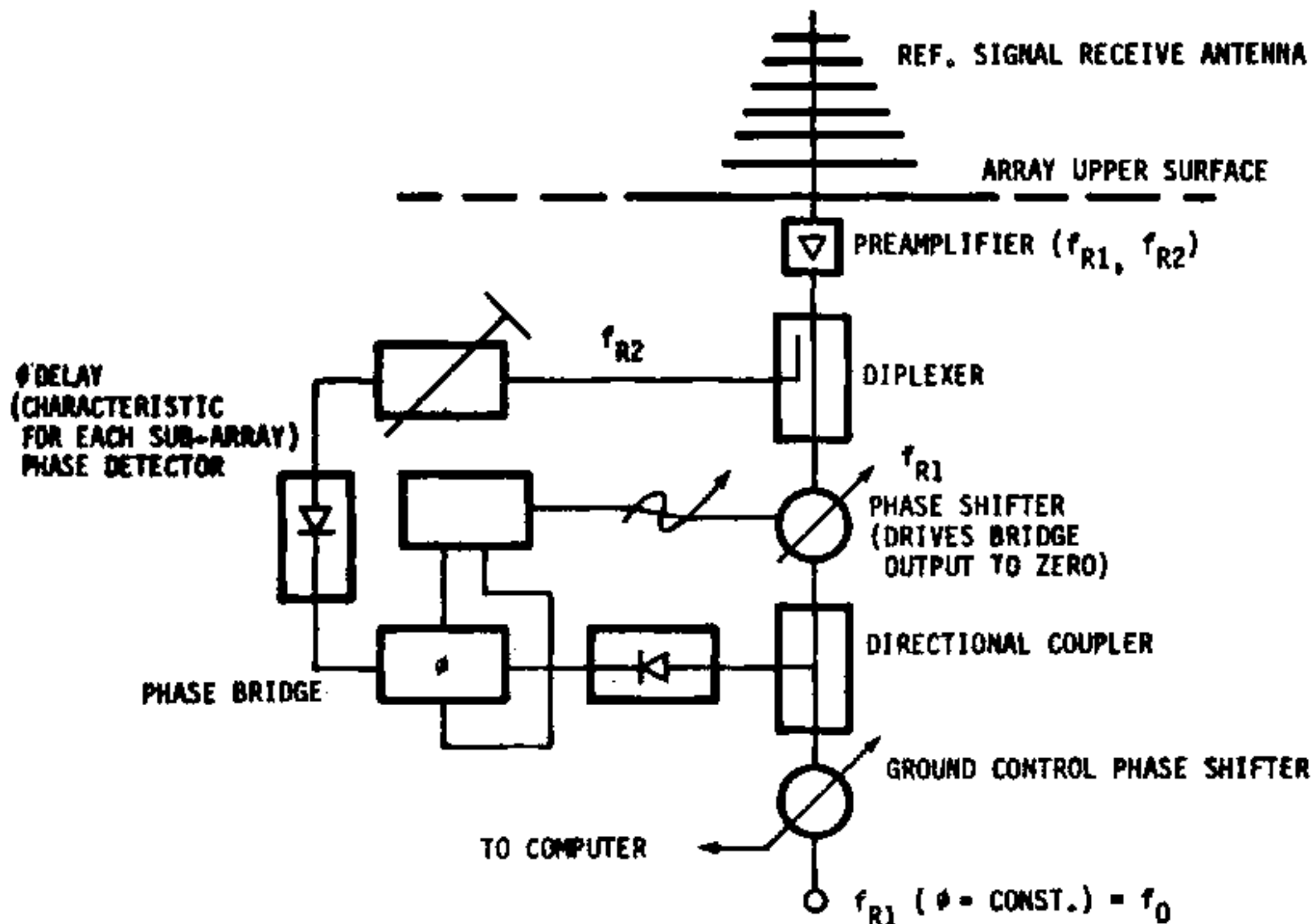

FIGURE 3. PHASE REFERENCE SIGNAL DISTRIBUTION SYSTEM



NOTE: PICK-UP ANTENNA ORTHOGONALLY POLARIZED WITH RESPECT TO POWER BEAM
 TOTAL ISOLATION $I_T \geq 40 + 60 \text{ dB} \geq 100 \text{ dB}$
 CROSS POL FRONT-TO-BACK RATIO (CAN BE MADE $>100 \text{ dB}$)

FIGURE 4. REFERENCE SIGNAL CONTROL LOOP



SOLID STATE TECHNOLOGY

David G. Weir
RCA Laboratories

A solid state transmitter could provide the SPS with long life, high reliability, graceful degradation, and low maintenance. These important characteristics are only secondary, however, to the need for high dc to rf conversion efficiency. The key question today is, can 80% conversion efficiency be obtained?

Analysis of numerous device concepts available for consideration eliminates all but a very few. The gallium-arsenide field effect transistor is today's first choice. Studies of theoretical models and experiments on existing devices seem to indicate that the GaAs FET has the potential for 80% dc to rf efficiency. Size and hence power levels must be limited (1 to 10 watt range) for this to be so.

NASA has sponsored theoretical device studies through Rockwell International and is now funding an evaluation demonstration program at RCA Laboratories. Samples of the best available devices are being evaluated for maximum performance and then built into demonstration amplifier circuits. A careful study of microwave waveforms is expected to help gain a better understanding of the critical mechanisms affecting efficiency and ultimately to provide parametric information for new device designs.

Twenty-five devices of seven types have been tested to date. The best results are 60% efficiency at 5.1 watts and 72% efficiency at 1.2 watts. Two amplifiers were delivered in April, meeting the Task 1 goals of 5 watts, 50% efficiency, and 8 db gain. The waveform analysis has revealed a significant relationship between efficiency and gate resistance. The results of this program, when completed later this spring, are expected to continue to show that 80% efficiency is achievable and to suggest valid ways in which this goal may be met.

[Extended Abstract Not Received]

MICROWAVE POWER TRANSMISSION WORKSHOP SUMMARY

John W. Freeman

Rice University - Houston, Texas 77001

Introduction

The Satellite Power System (SPS) Workshop on the Microwave Power Transmission System (MPTS) was held at the Johnson Space Center in Houston, Texas on January 15-18, 1980.

The objectives of this workshop were to assess and critique the assumptions, methodologies and conclusions of the NASA SPS studies and to identify and assess critical issues and to make recommendations for follow-on work.

The workshop review panel consisted of Dr. Robert C. Hansen, Prof. Bernard D. Steinberg, Prof. Aldo V. da Rosa, Mr. Harry Goldie, Dr. Paul Tallerico, Prof. William L. Wilson, Jr., and Dr. John W. Freeman. Presentations by NASA personnel and contractors were arranged by R. H. Dietz of NASA/JSC. The review panel assessment may be summarized as follows:

Beam Forming and Control

The present retrodirective phase control system has the following disadvantages: 1) inadequate provision has been made for security and anti-jamming protection; 2) ionosphere problems or other uplink disturbances or interruptions could lead to sudden and complete loss of function; 3) adequate long-term stability of the narrow band notch filter used for suppression of the power transmitter at 2.45 GHz is questionable in real world technology; and 4) aging and mistuning may lead to phase drift problems in the onboard circuitry.

Additional potential problem areas are: 1) mutual coupling among the microwave amplifiers and 2) possible underestimation of the power in the far sidelobes due to position errors in the phase centers of the subarrays and power modules.

Although there was not complete agreement, the panel tended to favor a closed-loop phase control system over the retrodirective approach. The onboard broadcast phase reference system presented by Rockwell in connection with the solid state sandwich configuration seems appealing because of its freedom from ionospheric variations and interruptions. Work should proceed on both closed loop and open loop systems. None of the phase control systems presented are clearly superior at this time.

Microwave Amplifiers

There is still no definite answer as to which choice is optimum for the microwave power amplifier devices. At this time the klystron looks most favorable, but either the solid state or magnetron source may look better later. The question of optimum power transmission voltage and amplifier size should be very carefully studied and re-examined. Some attempt should be made early to determine the maximum voltage which can be safely used in the SPS environment, as this has a significant bearing on many design decisions. If it is not possible to operate at 40-50 kV, then klystrons cannot be used. While ohmic and klystron efficiencies increase at higher voltage, reliability of power conditioning equipment and the klystrons decreases. Water cooling of the klystron looks troublesome.

Noise and harmonic generation is a major problem with any of the power amplifiers being considered; however, it appears that the klystron will have better noise characteristics than the solid state or magnetron devices.

Solid state devices have to overcome problems of noise, efficiency and high temperature operation before they can become viable contenders in the MPTS. As soon as reasonable solid state devices can be fabricated, an extensive test

program should be initiated for determining failure mechanisms and radiation sensitivity. Cooling, and maximum allowed temperature are critical to the design of a solid state MPTS. Cost may turn out to be a serious problem for the solid state devices because of the large quantities that will be required.

Injection-locked magnetrons may offer substantial promise from a cost point of view, however, substantial work needs to be done at the device level in the area of noise reduction and improved efficiency. The panel recommends further work in this area.

In the efficiency budgets produced so far, only the most optimistic predicted values have been used for the estimates of DC to rf conversion. A more conservative approach would be to use demonstrated efficiencies, with the variabilities of loading and performance included.

Radiating Elements

The principal problem the panel identified in this area is related to materials. Aluminum looks attractive except for its bad thermal expansion characteristics. Work should be initiated to see if there are any manufacturing or design techniques which would ameliorate this.

Although low CTE composites were mentioned frequently during the Workshop, there was no evidence presented which would indicate that these materials would in any way be suitable for microwave circuitry on the SPS. Obvious problems which come to mind include outgassing from the epoxies, conductor adhesion problems, and fabrication techniques. At the present time, these materials are a complete unknown, and should not be relied upon too heavily in the SPS design.

Problems of I^2R losses should also be addressed early so that potential later snags can be avoided.

The multipacting problem was mentioned frequently. Although this phenomenon is fairly well understood, there does not seem to be enough data at the present time to be able to predict if it will be a problem in the MPTS radiator.

Finally, the problem of harmonic interaction with the radiating structure needs to be addressed. It will not be feasible to place filters, circulators, or much else between the power amplifier and the radiating element without introducing unacceptable losses. Thus, harmonic suppression on the SPS itself must be achieved with the design of the radiating elements.

The Rectenna

The major problems which the panel sees are those of weather protection, parts count, and harmonic re-radiation. The demonstrated efficiencies at Goldstone have shown that the basic concept is reasonable, but have not answered the question of scaling this approach to SPS power levels and larger mass produced arrays.

Regarding harmonic generation and re-radiation, the amount of harmonic suppression possible with any economically reasonable filter placed on 10^{10} individual elements does not seem to be sufficient to limit the harmonic signals to an acceptable level. The only logical approach is to look for ways to lower the number of individual receiving elements, so that more care can be exercised in their design and construction.

Some form of weather protection or radome will be needed over all of the active elements in the rectenna.

The rectenna is presently a major cost factor in the total SPS system. As such, it should be subjected to careful cost effectiveness sensitivity studies which might point towards a slightly less efficient system, but with substantial

cost savings.

General Conclusions and Summary

The panel believes that top priority should be given to determining a hard upper limit for the permissible microwave power density which can be sent through the ionosphere. The number being used, 23 mW/cm² is based on an obsolete theoretical foundation and is without experimental support, and yet it is a constraining parameter in a number of the SPS design areas.

The panel believes that the final system will probably not look much like the present reference system and urges NASA to recognize this in all future planning. Work on novel concepts is encouraged.

The panel recommends more attention to systems engineering and failure analysis. Sensitivity trades should be employed to reveal optimum design parameters and review early design decisions.

In view of the magnitude and potential importance of the SPS, the panel recommends major program management status and a single program office within NASA for greater coordination of the contractor effort.

In Summary

It is the consensus of the MPTS workshop review panel that a 5 GW SPS microwave power transmission system is probably technically feasible. However, a large amount of work will be necessary in a number of areas to establish certainty and to determine system efficiency, reliability, rf compatibility, security, safety, longevity, and cost.

OFFSHORE RECTENNA FEASIBILITY

John W. Freeman[†], Don Heryey^{*}, and Peter Glaser[°]

[†]Rice University, ^{*}Brown and Root Development Inc., and [°]Arthur D. Little, Inc.

Rice University with subcontracts to Brown and Root Development Inc. and Arthur D. Little Inc. has performed a preliminary study of the feasibility and cost of an offshore rectenna to serve the upper metropolitan east coast. The study proceeded by first locating a candidate site at which to build a 5 GW rectenna. The site was selected on the basis of proximity to load centers, avoidance of shipping lanes, sea floor terrain and conditions, etc. Several types of support structures were selected for study based initially on the reference system rectenna concept of a wire mesh ground screen and dipoles each with its own rectifier and filter circuits. The study also looked at possible secondary uses of an offshore rectenna.

The principal results of this study are as follows:

1. Suitable candidate sites exist off the northeast coast and probably all along the east coast and Gulf of Mexico.
2. Hurricane and winter storm conditions were examined for this area and a set of environmental criteria were established.
3. The winter storm criteria plus tests done at Rice University under icing conditions lead to the conclusion that a protective radome will be required over the active elements of the rectenna including a portion of the ground plane. This conclusion probably also holds for land rectennas located everywhere except perhaps in the desert southwest.
4. For the reference system rectenna (using a wire mesh ground plane and individual dipoles), a double pendulum, two level rectenna panel, which can swing freely is suitable (see figure 1).
5. Approximately 25,000 support towers would be required for a 5 GW antenna using the above reference system rectenna.
6. Four different types of support tower structures were studied and costed. The least expensive of these was the piled guyed tower.
7. For the 49.4m (162 ft) water depth site examined the total cost of a 5 GW rectenna using the piled guyed tower and reference rectenna panel is estimated at \$36 billion. This is considered too expensive for serious consideration. The reference system is not suitable for offshore use.
8. The water depth, wind loading and soil condition cost sensitivities were examined. None of these factors could be altered sufficiently to significantly reduce the cost.
9. Based on the foregoing, the only substantial way to reduce the cost of the offshore rectenna is to reduce the number of support towers or go to a fully surface floating system. Reducing the number of support towers requires a change in the type and mass of the rectenna panels.
10. The number of support towers can be reduced from 25,000 to 3,000 by eliminating the ground screen and adopting an image dipole reflector antenna (figure 2) where each of the dipole plus reflector elements are supported individually by cables which also carry the power from the dipoles. This is called the clothesline concept. Each dipole plus reflector is individually encapsulated to protect it from the weather.
11. The cost of this clothesline concept for the 49.4 m water depth site is estimated at \$5.7 billion.

12. This demonstrates the cost reduction potential possible with new rectenna concepts. The clothesline concept is only one of several possible concepts. Time and fiscal constraints have prevented us from examining a surface floating rectenna, however, Peter Collins in England has estimated the cost of a North Sea floating rectenna at about \$6 billion.

13. Secondary uses, in particular mariculture, mineral extraction and hydrogen generation appear as promising adjuncts to the offshore rectenna. The possibility of wave energy extraction has also been examined briefly. Such secondary uses do not appear to constrain the basic rectenna design significantly.

14. A major problem identified with the reference rectenna offshore version is the sea birds which will be attracted to the vicinity of the rectenna and will land and roost on it. This requires further study, but it appears that the more open structure of the clothesline concept will reduce the bird problem somewhat.

In Summary

We have demonstrated that an offshore rectenna near east coast load centers is feasible. We have not yet demonstrated the practicality of such a system, nor has the design been optimized for cost, efficiency or minimal harmonic reradiation. The secondary and fuel generation uses remain to be fully explored.

Even at this early stage we believe that the offshore rectenna feasibility has been demonstrated and that with the significant advantages of no land requirements and removal of the radiation from populated areas which may offset any additional costs, further investigation of the offshore rectenna should be vigorously pursued.

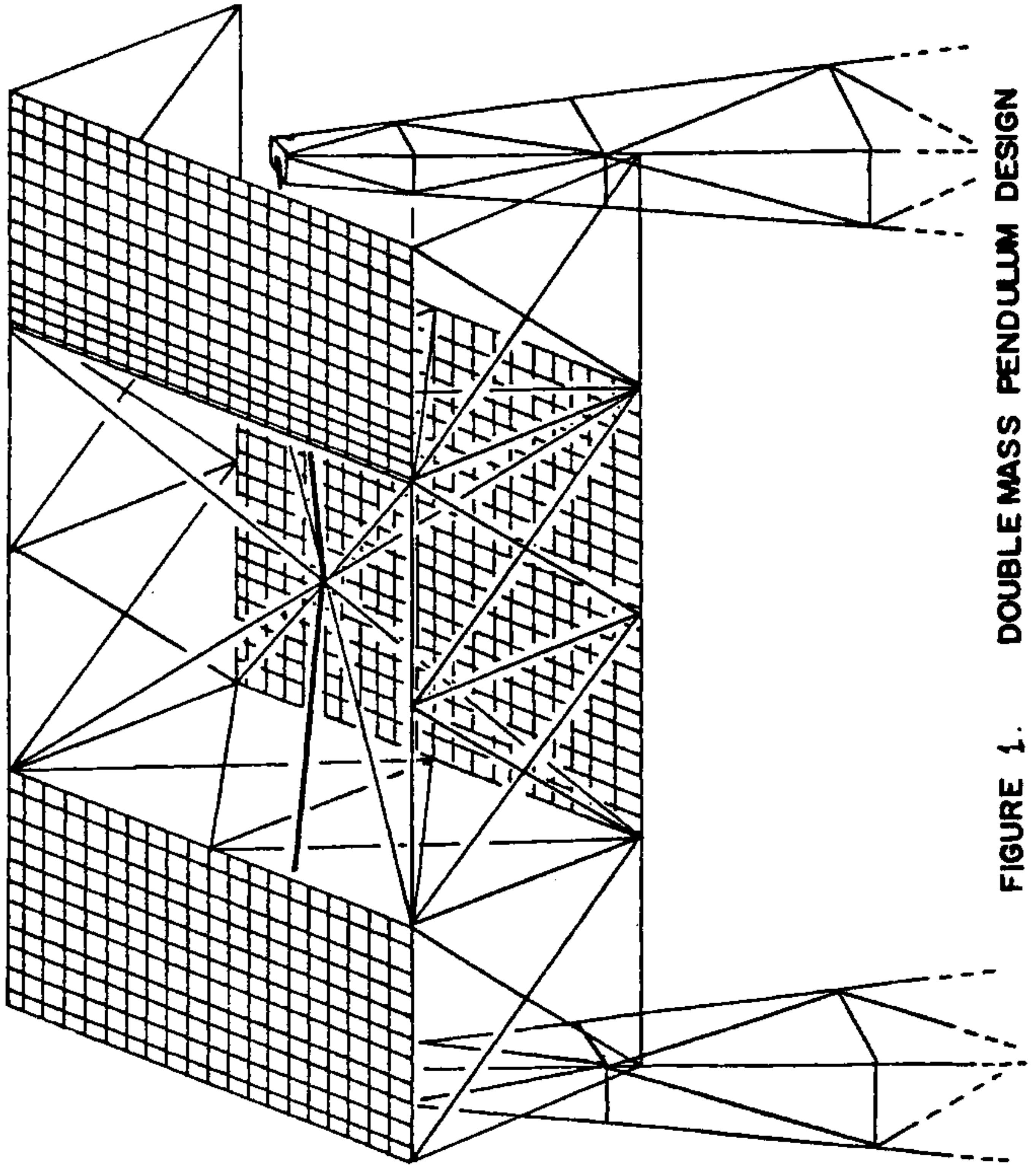

FIGURE 1. DOUBLE MASS PENDULUM DESIGN

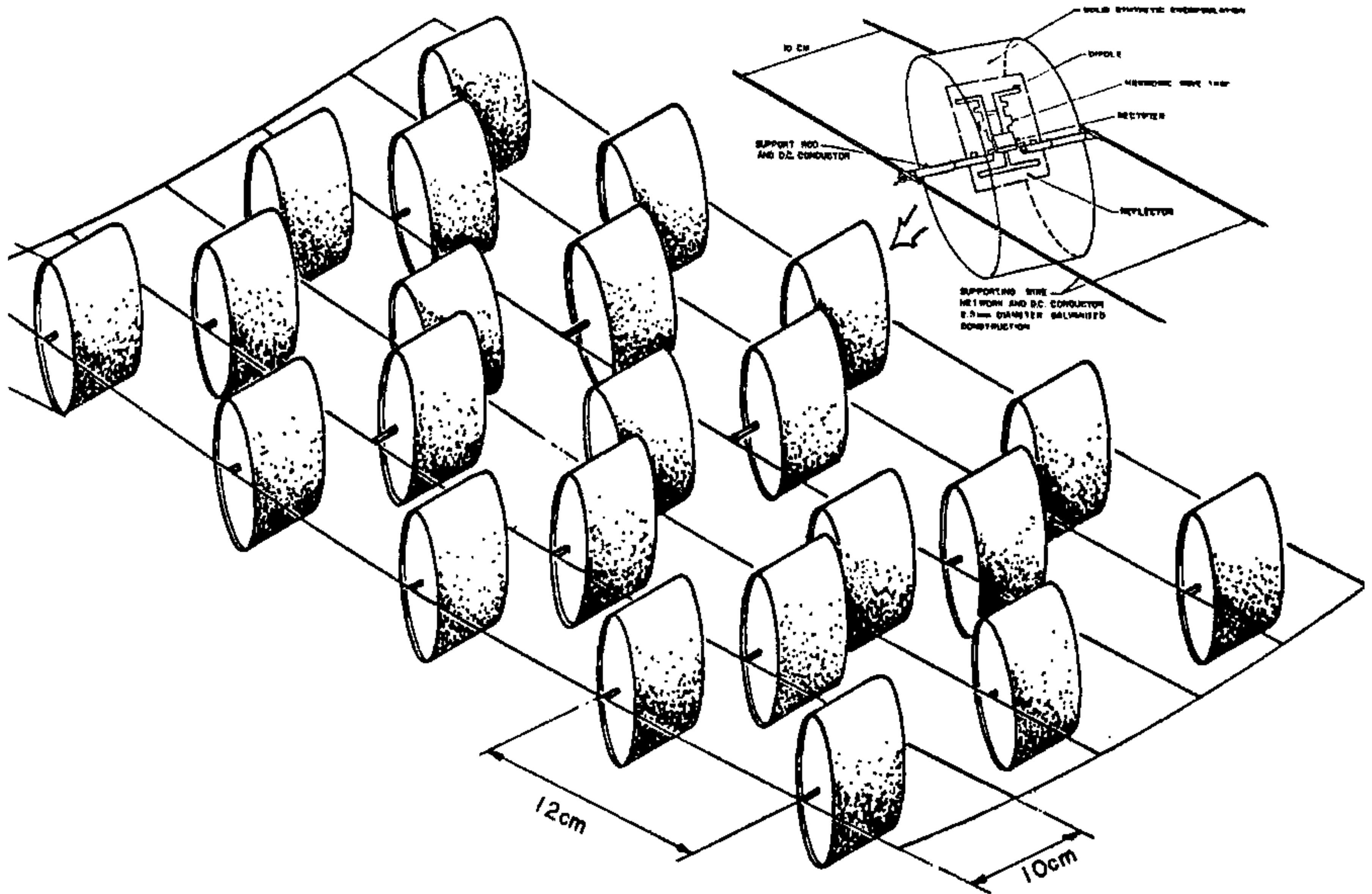

FIGURE **DIAGRAM SHOWING SECTION OF 100FT X 100FT NON-GROUND PLANE DIPOLE MICROWAVE RECEIVING ARRANGEMENT**

HIGH-POWER MICROWAVE OPTICS FOR FLEXIBLE POWER TRANSMISSION SYSTEMS

K. Eric Drexler - M.I.T. Space Systems Laboratory, Cambridge, Massachusetts
B. Ray Sperber - Boeing Aerospace Company, Seattle, Washington

In the conventional SPS concept, a one kilometer diameter phased array broadcasts directly to a ten kilometer wide rectenna. Diffraction optics, economics, and microwave power density limitations at the transmitter and in the ionosphere set the power of this system at 5 GW, and have restricted consideration of alternative systems to powers within a factor of two of this level. While such a system might prove attractive, a system with far greater flexibility appears feasible. A non-optimized concept is presented below.

A large concave microwave mirror near the transmitter can magnify the apparent size of the Earth as seen from a phased array, and vice versa, permitting a small phased array to be coupled to a small rectenna while preserving the transmission efficiency (the reflection loss is slight) and peak power densities characteristic of the reference system. This augmentation of the phased array aperture with a large mirror gives the system greater resolution (in the optical sense), and opens new degrees of freedom in SPS design. The consequences of such an approach for a prototype satellite have been explored (1,2). The following will discuss its consequences for a mature SPS system.

Using this approach, the mature SPS will have many phased array feeds utilizing a common mirror to couple to many rectennas. Total satellite power might be some 20 to 50 GW (reducing the number of orbital slots needed), with a mirror perhaps 5 kilometers in diameter, and of 100 kilometer focal length. Such a mirror must be actively configured and could be quite light (3,4,5). Figure 1 illustrates a gravity gradient stabilized configuration. Since a mature SPS system will surely involve active structural control, no attempt has been made to make the structure rigid (permissible deflections in the microwave optical path are minute). System mass is discussed in Table 1.

As Figure 2 indicates, the phased array feeds are located in front of the mirror's focal plane, at a point where a power density equal to that of the reference system's transmitter will produce the reference system's power density at the ground. At this point aberration from the mirror produces only minor variations in phase and power density relative to a perfect optical system. The array is large enough and close enough to the mirror to have independent control over the phase and power density at some 100 resolution elements on the mirror, justifying the assumption made regarding control of the outgoing beam. Calculations assuming a spherical mirror indicate adequate performance, which can surely be improved on.

This augmented-aperture system behaves like a retrodirective array five kilometers across and able to form many beams. Since it is five times the diameter of the reference system antenna, it can efficiently serve a 2 kilometer, 200 MW rectenna. Busbar power cost will be slightly higher than for the reference system, because of the added system element, but busbar cost is only part of the system cost. Power transmission on the ground adds sub-

HIGH-POWER MICROWAVE OPTICS...

stantially to the typical user cost of SPS electricity. By breaking up the power beam into smaller blocks, transmission lines can be made shorter, thereby lowering their construction costs and increasing their efficiency. Smaller power blocks will increase market penetration by opening smaller markets (including those in the Third World), by lowering costs of service to decentralized markets, and by smoothing introduction of SPS power into the grid.

In the geometric optics approximation (appropriate to larger phased arrays and larger beam powers than those discussed above), defocused optics can map a tophat power density distribution at the phased array into a tophat distribution at the ground. On the ground, this cuts land requirements by about a factor of three, given a constant peak power density, while increasing power conversion efficiency. In space, this cuts phased array area per unit power by a comparable factor. Diffraction will reduce this performance, but the cost savings should still be large enough to reduce busbar costs substantially.

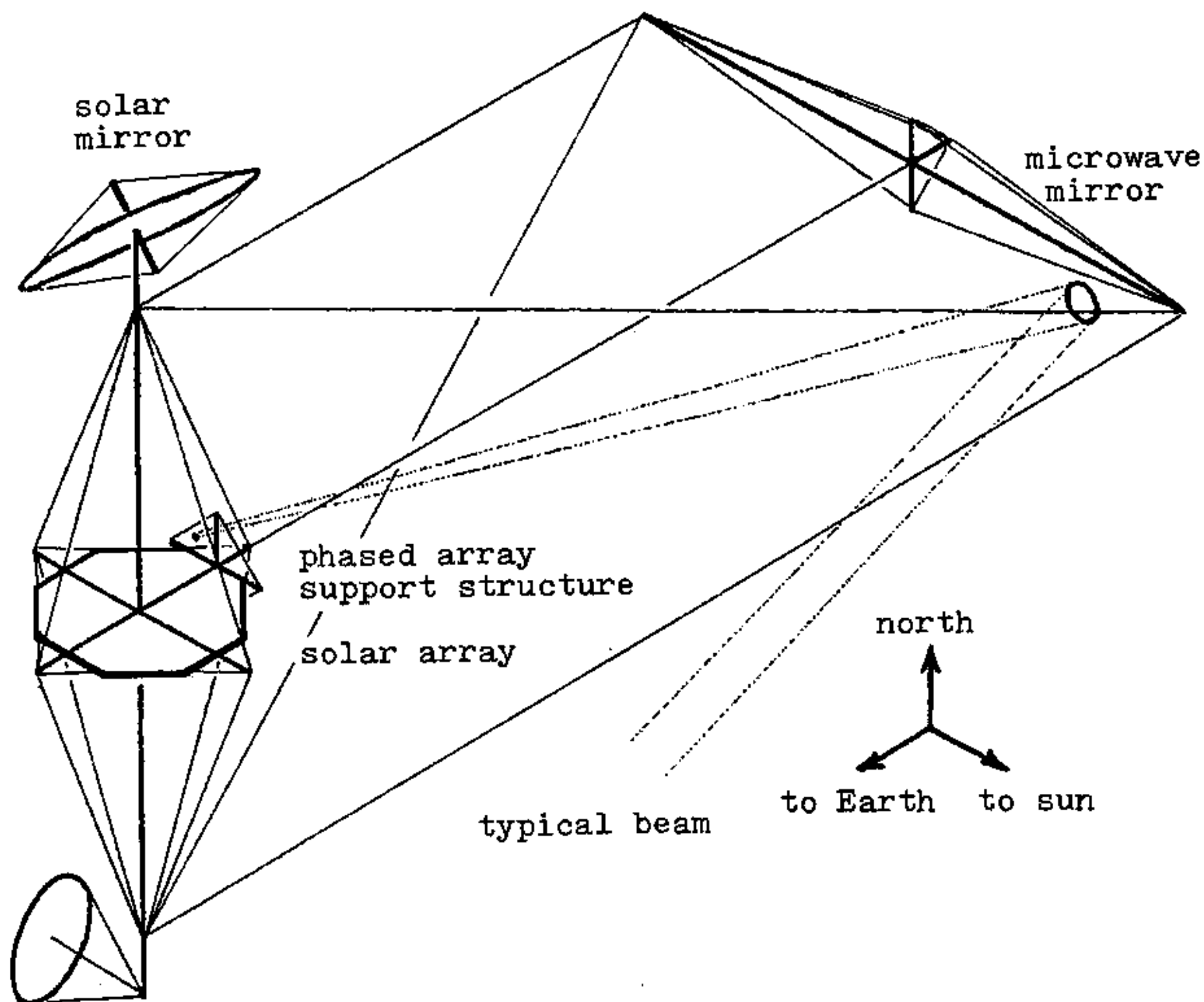

FIGURE 1: A gravity-gradient stabilized configuration, incorporating a rotating solar mirror and no rotating electrical joint. Length about 100 kilometers.

HIGH-POWER MICROWAVE OPTICS...

Since a tophat system is not diffraction limited, the power can be focused into a smaller spot. Redundant safeguards can doubtless be devised to prevent accidental focusing. More complicated optical systems might be devised that would prevent deliberate focusing unless the satellite was rebuilt. In any case, all proposed systems incorporate the retrodirective array concept and thus require an actively cooperating receiver.

With a cooperative receiver, even the reference system can produce high microwave intensities on the ground by delivering beams from many satellites to the same place. The large, multi-beam satellites proposed here cannot do this so readily, since there are fewer of them, and since each can only deliver a small fraction of its power to a single location.

The greater resolution of the aperture augmented system can lower sidelobe power densities, reducing land use or any low-level microwave hazards that may be discovered. Greater resolution permits not only smaller beams, but beams of non-circular cross section, increasing flexibility of rectenna siting. These features reduce objections that have been raised against the reference system.

Further, since each satellite can provide a small fraction of the power needs across a continental area, each section of the power grid on the ground need not depend on any one satellite for more than a small fraction of its power supply. This reduces the cost of back-up power supplies needed in case of satellite failure, and softens the effect of satellite eclipse.

The mere size of the satellites need not produce institutional difficulties and centralization (the Earth is a pretty big solar power satellite itself). The structural framework and mirrors could be treated as an industrial park supplying certain services. Local utilities could then lease sunlit area for generating facilities (which need not all be of the same type, or installed at the same time), and lease transmitter locations in the focal plane of the mirror corresponding to their ground rectenna sites. Since the focal plane maps whole continents in miniature,

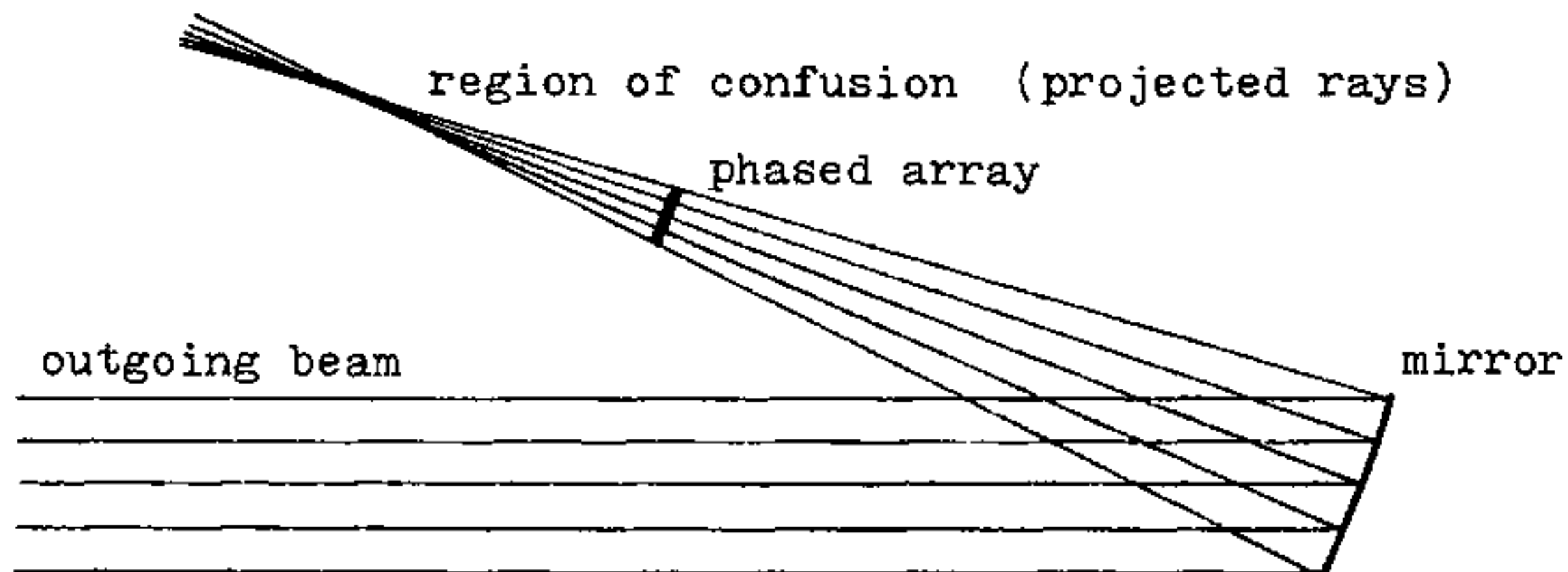

FIGURE 2: A ray-optics illustration, showing mirror aberration and the placement of the phased array in front of the zone of confusion. Not to scale.

HIGH-POWER MICROWAVE OPTICS...

utilities would find their generating facilities in space hundreds of times closer together than on the ground, permitting inexpensive load smoothing across time zones. Indeed, such load smoothing encourages satellites with international coverage approaching hemispheric, making international ownership of the "industrial park" a natural (and stabilizing) institutional arrangement.

TABLE 1: Comparison of a 50 GW Satellite to the Reference System

- Microwave mirror: adds about 0.2 kg/kW, assuming a 5 km mirror with a mass of 500 gm/m².
- Ballast: adds about 0.3 kg/kw.
- Conductors: add about 0.5 kg/kW, without reoptimization.
- Solar mirror: adds about 0.4 kg/kW, assuming mirrors with a mass of 20 gm/m² (JPL's solar sails were under 10 gm/m²).
- Main masts: add about 0.01 kg/kW, assuming 3 * 10⁻⁴ kg/N-m.
- Solar array: essentially the same mass per unit power.
- Phased array: may save up to about 0.8 kg/kW, depending on the fraction of power in tophat-profile beams.
- Thus, the capabilities described in this paper may be acquired by adding some 30% to the reference system mass, largely in the form of structure, conductor, and ballast. In an era of maturing space technology, these may plausibly be obtained at low cost from nonterrestrial sources. The mass that may be saved in the phased array (up to some 15%) is apt to be of greater value because of its greater sophistication.

Acknowledgment:

Special thanks to Carolyn Henson for suggesting that the satellite might be treated as an industrial park.

References:

- 1) K.E. Drexler and T.A. Heppenheimer, "On the feasibility of small power satellites." Journal of Energy, 1:200 (1977).
- 2) K.E. Drexler and B.R. Sperber, "An aperture-augmented prototype power satellite." Journal of Energy, 2:318 (1978).
- 3) J.H. Lang, J.R. Gersh, and D.H. Staelin, "Electrostatically controlled wire-mesh antenna." Electronics Letters, 14:655 (1978).
- 4) G.W. Goslee, "Electrostatic forming." Large Space Systems Technology, 1979, NASA Conference Publications 2118, p 187.
- 5) D.C. Montgomery and L.D. Sikes, "Development of the maypole hoop/column deployable reflector concept for large space system applications." Large Space Systems Technology, 1979, NASA Conference Publications 2118, p 115.

SPS POWER TRANSMISSION - ARE MULTIPLE BEAMS A BETTER OPTION FOR EUROPE?

Ross A. Henderson and John P. Stark
British Aerospace Dynamics Group - Bristol UK

The US baseline SPS Reference System dictates an electrical input to the utility grid, of 5 GW (gigawatts) transmitted from geostationary orbit via microwave energy. This power level is proved to be the optimum in relation to parameters such as the net cost of supplied electricity, transmit antenna size and benign ionospheric interaction of transmitted power energy. The addition of a 'safe' microwave environment at the ground receiving site (rectenna) leads to very large intercept area which becomes disproportionately large at European latitudes.

The environmental, political, economic and social impact of these rectennas are enormous even if 'off-shore' siting is feasible; however, the additional technical and operational problems imposed by these large centralised power utilities demand a new approach to the future planning of involved utility supply industries.

A multibeam microwave transmission concept is proposed which has minimal impact on present SPS concepts. The rectenna areas are significantly reduced and can be related more closely to user country or 'community' requirements for electrical power needs. Utility grid costs and complexity are reduced; interface requirements being commensurate with present technology.

In deriving alternative system configurations, it is necessary to ascertain those parameters which must not be varied, those that can be marginally varied, and those to which the system is relatively insensitive.

In the first case come those parameters relating to the safety levels of the microwave beam and the thermal levels for the transmitting antenna. Thus the configurations considered maintain a peak flux density of 23 mW/cm^2 in the beam and peak heat dissipation levels of 22 kW/m^2 on the transmit antenna. Additionally, safety zones 1 and 2 are defined as having peak flux densities of 1 mW/cm^2 and 0.02 mW/cm^2 respectively. The transmitting frequency remains 2.45 GHz and the total power input to the ground utility system/satellite remains 5000 MW.

Parameters dependently varied are the spacetenna and rectenna sizes, this dependence arises from the ionospheric peak flux, the heat dissipation at the transmitter, the total power in the beam and the transmission efficiency. If the transmitting antenna diameter is increased, a narrower beam can be produced (leading to smaller rectenna areas), but to keep the peak fluxes in the ionosphere below the above limits, the total power in the beam must be reduced. The efficiency of the beam transmission is dependent upon the product of the space and ground antenna areas and in developing the multiple beam concept this efficiency is kept invariant.

There are several ways in which one might realise a multiple beam phased array antenna. Of these, the one which adheres most closely to the system requirements is by adoption of an aperture distribution which is configured from n identical distributions. Although the use of n superimposed phase distributions on each radiating element appears attractive, element mutual coupling could prove to be a severe problem.

Several configurations were investigated; however, the option presented here is a system where three beams, each providing 1670 MW, are transmitted from three 10 dB truncated gaussian tapers (each of radius 0.593 km).

The consequent system parameters are summarised in Table 1 but it is noted that the safety areas (zone 1 and zone 2) for each beam are decreased by 58% and 26% respectively. The rectenna area for a single beam decreases by 30% although the total reception area for the 5000 MW grid input is doubled. The cost for each satellite is at least double present estimates, mainly due to the increase in the spacetenna. It is feasible to reduce the rectenna size by a further factor of 2 by reducing the transmission efficiency. This leads to either an increase in solar array size or a decrease in the overall system level of 5000 MW. The costs are significantly increased for the former case but marginally reduced in the latter case and do not appear viable at this time.

It is noted that recent work on solid state dc-rf conversion solar power satellites indicate negligible change to overall systems design with the introduction of a multiple beam concept, as discussed above.

Finally, although the impact on costs for a klystron concept solar power satellite is high, the concept significantly reduces ground area use for rectenna sites and substantially reduces the impact on land utilisation outside of the rectenna. This could have significant implications for the future implementation of solar power satellites in high density population/arable land areas, particularly in Western Europe. Future analysis is planned to optimise fully the system design and establish the economic viability of the concept particularly for solid state microwave transmitter solar power satellites.

TABLE 1:

DESIGN PARAMETER VARIATION FOR A MULTIPLE BEAM
SPS NORMALISED TO THE REFERENCE SYSTEM GUIDELINES.

DESIGN PARAMETER	REFERENCE DESIGN GUIDELINES	MULTIPLE BEAM SYSTEM DESIGN VARIATIONS
Input Power to Grid Interface	5000 MW	Single Beam: 33% System: 0
Solar Array: Rockwell Point Design	26.52 KM ²	0
Boeing Point Design	52.34 KM ²	0
Transmit Antenna Diameter	1.0 KM	256%
Number of Subarrays (4 + 36 Power Modules)	7220	Single Beam: 114% System: 416.5%
MPTS Efficiency	85.9%	0
Power Density:		
- At the Transmit Antenna	22 KW/m ²	0
- At the Ionosphere & Beam Boresight (Ground)	23 MW/cm ²	0
- At the edge of the Rectenna	1 MW/cm ²	0
- Maximum Level in Safety Zone 1	1 MW/cm ²	0
- Maximum Level in Safety Zone 2	0.02 MW/cm ²	0
- Maximum Level Outside of Safety Zone 2	0.01 MW/cm ²	0
Rectenna Size at 52° N Latitude	163 KM ²	Single Beam: 70% System: 210%
Safety Zone 1 Size at 52° N Latitude	651 KM ²	Single Beam: 14% System: 42%
Safety Zone 2 at 52° N Latitude	1468 KM ²	Single Beam: 25% System: 74%
TOTAL SPS COSTS (INV/SATELLITE):		
- Rockwell Point Design	13.9 B\$	303% *
- Boeing Point Design	12.3B\$	215% *

* Excluding Space Transportation.

ELECTRIC POWER PROCESSING, DISTRIBUTION, MANAGEMENT AND ENERGY STORAGE
Robert J. Giudici
NASA/Marshall Space Flight Center

Power distribution subsystems are required for three elements of the SPS program: (1) orbiting satellite, (2) ground rectenna, and (3) Electric Orbiting Transfer Vehicle (EOTV). Power distribution subsystems receive electrical power from the energy conversion subsystem and provide the power busses, rotary power transfer devices, switchgear, power processing, energy storage, and power management required to deliver regulated power to the load. The grounding, electromagnetic interference control, high voltage plasma interactions, electric thruster interactions, and spacecraft charging of the SPS and the EOTV are also included as part of the power distribution subsystem design.

The satellite power distribution subsystem (PDS) is essential but incurs weight and power loss penalties, representing cost, to the SPS. The design approach must be: (1) to define feasible PDS concepts that can accommodate unprecedented power and voltage levels, (2) to perform system level trade/optimization studies, (3) to select a PDS that minimizes the SPS penalties, and then (4) to develop the high performance components needed to implement the subsystem.

This paper will consider the preliminary SPS concepts developed by Rockwell and Boeing from the standpoints of reducing subsystem requirements and of minimizing SPS penalties. Performance improvements and projections will be addressed and technology developments will be suggested.

The significance of system level studies to the selection of a PDS design can be reviewed with the aid of Figure 1.

The solar photovoltaic/sandwich concept, wherein solar cells are connected back to back with solid state direct current (d-c) to radio frequency (r-f) converters, requires no switchgear or power processors. The solar cells are merely connected via short interconnect busses to the solid state amplifiers and the result is an ideal negligible PDS.

None of the other system concepts shown in Figure 1 achieve this simplicity because the power source is necessarily located at a distance of several kilometers from the antenna, and for solar concepts, the power source must be pointed at the sun while the antenna maintains earth pointing. Therefore, power must be transferred across a rotary joint and must be transmitted at high voltage to maintain reasonable conductor size and power loss. It also follows that the PDS will require switchgear for the collection and management of power received from multiple sources and for redistribution to individual r-f converters.

The photovoltaic/klystron system design, indicated by heavy lines in Figure 1, is the present reference SPS concept, although it requires a complex PDS. The klystron r-f converter requires bulk power at multiple voltages ranging from 40 kV to 8kV and a small percentage of power at voltages as low as 20 volts. All of the bulk power could be supplied from solar array sections operating at the proper voltage but system studies conducted by Rockwell and Boeing have employed power processors for 20 to 80% of the power due to the heavy conductors required at lower voltages and the added circuit complexity of managing a multi-voltage system.

ELECTRICAL POWER DISTRIBUTION AND MANAGEMENT

FIGURE 1

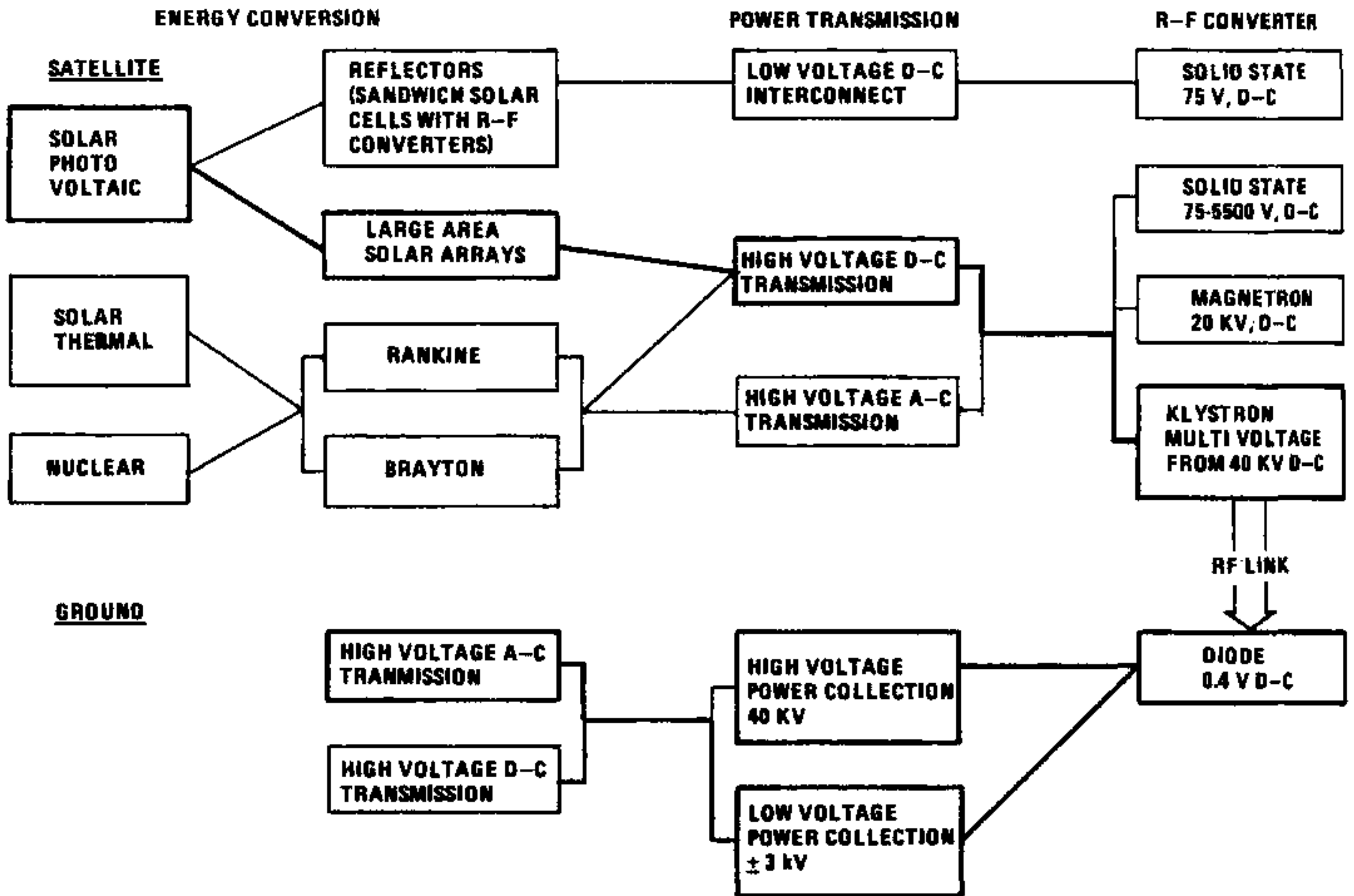

A magnetron r-f converter, proposed by Raytheon, has the potential to eliminate power processing requirements. The magnetron can be operated from a single 20 kV buss and has internal voltage tolerance (5 to 10%) which permits direct connection to a 20 kV solar array. The magnetron approach is expected to benefit the reference Boeing design due to their optimistic conductor designs and conservative projections for power processing performance. The opposite could be said for the Rockwell reference design. The magnetron may also favor solar thermal or nuclear concepts because alternating current (a-c) power received from the Brayton or Rankine machines can be easily rectified to 20 kV d-c.

The solid state r-f converter concept, when operated from large area solar arrays or Rankine or Brayton machines, is penalized by low voltage requirements (~200 volts). Power processing, necessary for 100% of the power, incurs a 5×10^6 kg mass and 4% loss penalty.

A similar penalty results from the use of low voltage solar arrays. Low voltage solar arrays (400 volts) have been considered as a contingency pending verification of the feasibility of multi-kV arrays. The power processing penalty would again be 5×10^6 kg mass and 4% loss.

High voltage a-c transmission has been a continuing trade study option and although a-c transmission designs can reduce power conductor and switchgear requirements, they require 100% power processing at the load and have therefore been less attractive than d-c designs.

The remaining element of the PDS, shown in Figure 1, is the ground rectenna system. The ground rectenna receives power from series connected diodes and provides switchgear, and power processors for connection to the utility grid. Equipment requirements have been considered to be relatively in-hand when compared with requirements of the orbiting satellite. The primary concern has been with overall satellite/ground rectenna power management when (1) the SPS is off-line for scheduled maintenance, (2) the SPS or utility grid experience partial failures, (3) peak on slack load is demanded from the utility grid.

The PDS required for the Electric Orbiting Transfer Vehicle (not shown in Figure 1) requires switchgear and power conductors to connect the solar array to the electric thrusters. Power processors may not be necessary, depending on system performance trade studies involving solar cell (Si or GaAs) characteristics as a function of altitude. Energy storage, to operate a minimal number of attitude control thrusters during shadow periods, is dependent on trade studies comparing electric versus chemical thrusters.

The interaction of all satellite subsystems with the space plasma environment or other plasma created by electric thrusters or the outgassing of materials is included in the PDS investigations. This includes technology development to permit solar arrays to be operated in the multi-kV range; selection of insulation material to control spacecraft charging; and trade studies to optimize the location of electric thrusters and to select material with low outgassing characteristics.

Hardware that might be applied to PDS designs exists as high power, high voltage ground utility equipment or as low power, low voltage satellite equipment. The

hardware issues for the SPS designs are: (1) can the necessary large flight worthy equipment be developed to meet the unprecedented electrical requirements? (2) will the equipment meet performance and life goals? These issues require resolution through a Ground Based Exploratory Development (GBED) program.

Important issues that could benefit through exploratory development are tabulated in Table 1. The necessity for detailed investigations can be illustrated by considering power processing, space plasma interactions and energy storage.

TABLE 1. ISSUE TREE

ISSUES	SUB-ISSUES
Power Processing, Distribution, and Management High Voltage/High Performance 0.4 - 1.0 kg/kW 90% Efficiency 30 Year Life	Power Processing Performance and Thermal Control 0.2 to 1.0 kg/kW Switchgear 99.9% Efficiency Rotary Joint 200kA Power Conductors 0.124 w/g Insulators and Stand-Offs Auto Power Management
Space Environmental Interactions 1.0% Loss	S/C Charging @GEO High Voltage/Plasma Breakdown Thruster Interactions Plasma Interactions
Energy Storage Satellite Systems Management during Eclipse	High Performance Secondary Batteries 200 Wh/kg Fuel Cells/Ni H ₂ Batteries/ Superconducting Magnetics 40 Wh/kg Thermal 200 Wh/kg

High performance power processors are required for several system concepts of the SPS. Typical designs require 9×10^6 kW as input power to the satellite r-f converters to deliver 5×10^6 kW to the ground utility grid. Existing satellite power processors, with specific weights of 10 kg/kW, would add a clearly unacceptable 90×10^6 kg to an SPS reference designs having a total weight of 30 to 50×10^6 kg. Conceptual studies performed by Westinghouse and GE have projected that specific weights might be reduced to the range of 1 to .2 kg/kW. Although PDS designs strive to minimize power processing requirements, the effect that this type of uncertainty has on system level studies should be apparent.

The interaction between high voltage solar arrays and the space plasma is complex and made uncertain by the difficulty in obtaining credible test data. It is generally believed that present solar array designs will not operate satisfactorily at voltages above 400V. The major concern at this time is in finding a solution

to the glow discharge on "sparking" observed in vacuum chamber tests at LeRC and at JSC. A second concern is with charge exchange ions from electric thrusters that are attracted to solar cell surfaces and cause a high shunting power loss. The loss may be minimized for the SPS by proper location of the attitude control thrusters but it appears that biased screens will be required for the EOTV to prevent the charge exchange ions from reaching the solar array. Power loss due to the interaction of the solar array with the space plasma at low orbits is an additional major concern for the EOTV.

Energy storage is required by the SPS (1 to 15 mWh) and EOTV (0 to 300 kWh) to maintain attitude control during shadow periods. On-going development of high performance fused salt batteries (200-300 Wh/kg) by the DOE should be supported and alternative energy storage systems should be investigated.

HIGH VOLTAGE SYSTEMS (TUBE-TYPE MICROWAVE)/LOW VOLTAGE SYSTEM (SOLID-STATE MICROWAVE) POWER DISTRIBUTION

A.A. Nussberger, Rockwell International and G.R. Woodcock, Boeing Aerospace Co.
12214 Lakewood Blvd, Downey, CA 90241 P.O. Box 39999, Seattle, WA 98124

This paper describes SPS satellite power distribution systems, combining the study activities of Rockwell under contract to NASA MSFC (NAS8-32475), and Boeing Aerospace Company under contract to NASA JSC (NAS9-15636).

The reference satellite power system (SPS) concept (Figure 1) utilizes high-voltage klystrons (~40 kV) to convert the on-board satellite power from dc to RF for transmission to the ground receiving station.¹ The solar array generates this required high voltage and the power is delivered to the klystrons through a power distribution subsystem as represented in the simplified block diagram of Figure 2. An array switching of solar cell submodules is used to maintain bus voltage regulation. Individual klystron dc voltage conversion is performed by centralized converters. The on-board data processing system performs the necessary switching of submodules to maintain voltage regulation. Electrical power output from the solar panels is fed via switch gears into feeder buses and then into main distribution buses to the antenna. Power also is distributed to batteries so that critical functions can be provided through solar eclipses.

Major requirements include the klystron requirement for five basic voltages (40, 32, 23, 12, and 8 kV)—klystron body voltage (40 kV), mod anode voltage (20 kV), and low voltages for cathode heater (20 V), solenoid operation (20 V), computer (20 V) and retro-electronic (20 V)—are required in the Rockwell concept to operate 135,864 klystrons. These voltages at the required power level are provided by centralized dc/dc converters. The Rockwell point design provides 32 converters, each sized for 290 megawatts (7.19 kVA). The Boeing power distribution concept² is similar in that conditioned power is provided for all microwave power transmission elements. The five depressed collector klystron requires conditioned power on all inputs except the two collectors which utilize power directly from the solar panel supplies (Figure 3). A section of a Boeing subarray called the integrated klystron module is shown in Figure 4. It shows the klystron mounted on the back of the slotted waveguide antenna array. The passive cooling system can be seen. Also illustrated here is the phase control system installation on the subarray, required to insure that the radiation from the modules will be in phase at the rectenna. This system will tie modules within a subarray together with waveguide and all the subarrays together with coaxial cable or an equivalent transmission link.

The satellite system end-to-end efficiency chain is continuously being updated to reflect the latest values. Efficiency values used in the current studies are compared to values used in the NASA/DOE reference design for both gallium arsenide (GaAs) and silicon (Table 1).³

A major study goal has been to devise satellite approaches that use low-voltage solid-state devices for conversion from dc to RF on the satellite. The desire to replace the klystrons with solid-state devices is driven by their potential for highly improved satellite reliability; klystrons probably would have to be replaced at least two and perhaps three times during the 30-year operational period. Solid-state microwave design drivers are identified as maximum breakdown voltage limits (10 to 70 Vdc), junction temperatures (<200°C), output power limits (<100 W), and circuit efficiencies (78% to 90%).

Two basic approaches to using solid-state dc-RF converters have been evaluated: (1) power modules integrated on the solar array (sandwich concept), and (2) antenna-mounted power modules (solid-state power modules replace klystrons). A reference solid-state concept used for comparison purposes is shown in Figure 5. A two-reflector system is used to reflect sunlight onto the back of an antenna which contains GaAs solar cells integrated with the solid-state RF amplifiers in the sandwich configuration. Power is delivered directly from the solar cells at +10 volts and -4 volts to the power amplifier. A detailed cross-section of a Rockwell sandwich antenna dipole concept is shown in Figure 6. The solar cell configuration consists of 3 rows of 18 series connected GaAs solar cells to

¹Satellite Power System Concept Definition Study. Rockwell International, SSD 79-0010-2-1 (March 1979).

²Solar Power Satellite System Definition Study. Boeing Aerospace Company, D180-25037 (April 1979).

³Concept Development and Evaluation Program. U.S. Department of Energy and NASA Reference System Report (October 1978).

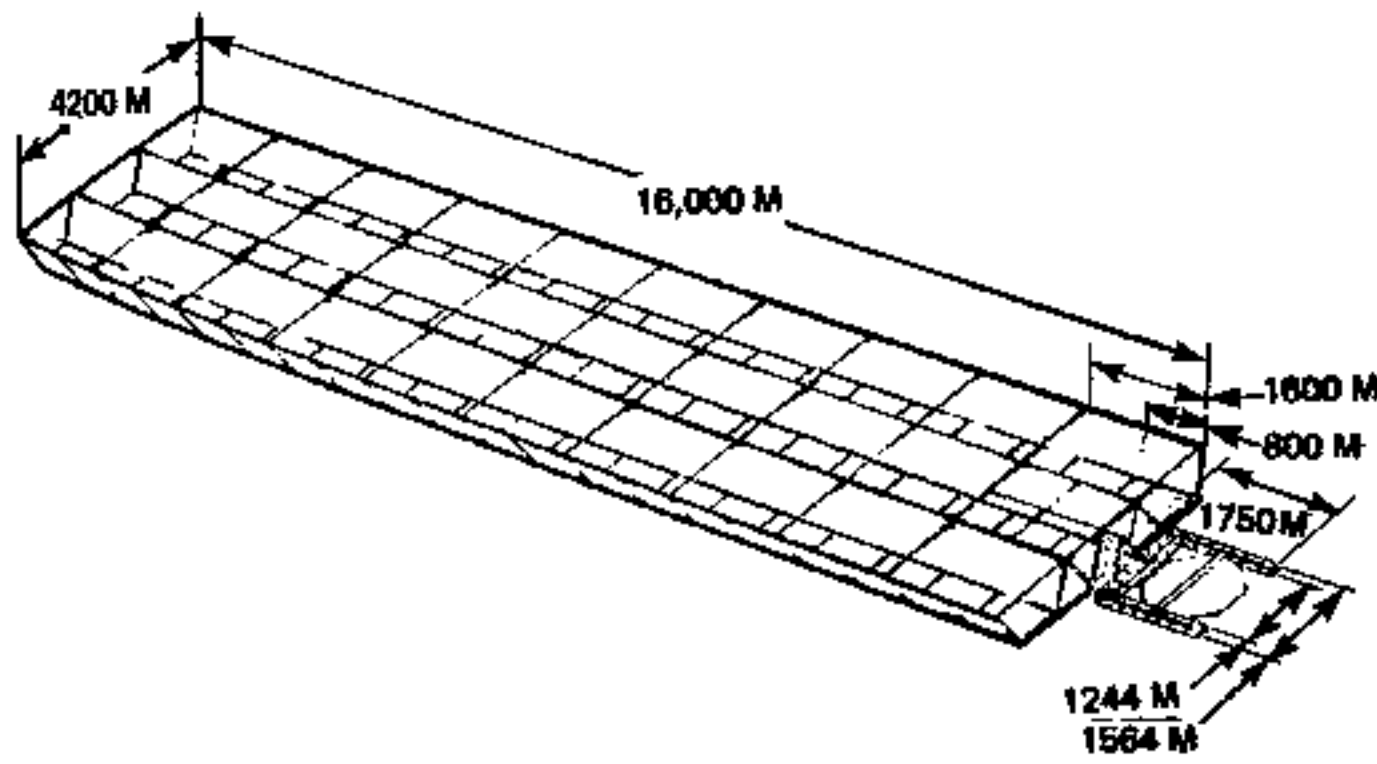

Figure 1. SPS Reference Configuration (GaAs Cells, CR=2)

Table 1. Efficiency Values

Efficiency Factor	Ref GaAs	Alternative	Ref Si	Alternative
Solar Array				
Summer Solstice	0.9675	(0.975)	0.9675	(0.975)
Seasonal Variation	0.91	0.968	0.91	0.968
Reflector Refl Degrad	0.915	0.915		
Solar Cell Eff at AMO (28° C)	0.20	0.20	0.173	0.173
Cell Temp Degrad (113° C)	0.908	0.908	0.954	0.954
Array Design Factor	0.901	0.89	0.951	0.89
UV & Radiation Degrad	0.96	0.96	0.9273	0.9273
Margin		0.975		0.975
Switch Gear Factor		0.997		0.997
Array Pwr Distrib	0.9368	0.939	0.9368	0.939
Slip Rings	0.9995	0.999	0.9995	0.999
Antenna/Ground				
Antenna Power Distrib	0.963	0.932	0.963	0.932
DC-RF Conv	0.85	0.85	0.85	0.85
Transmit Ant	0.9653	0.96	0.9653	0.96
Atmospheric Loss	0.98	0.98	0.98	0.98
Rect Energy Collection	0.89	0.862	0.89	0.862
RF-DC Conv	0.88	0.89	0.88	0.89
Ground Interface	0.97	0.936	0.97	0.936
Overall Efficiency %	6.97	6.49	7.058	6.176
MPTS Efficiency (dc-RF-dc) %	(63.0)	(61.4)	(63.0)	(61.4)

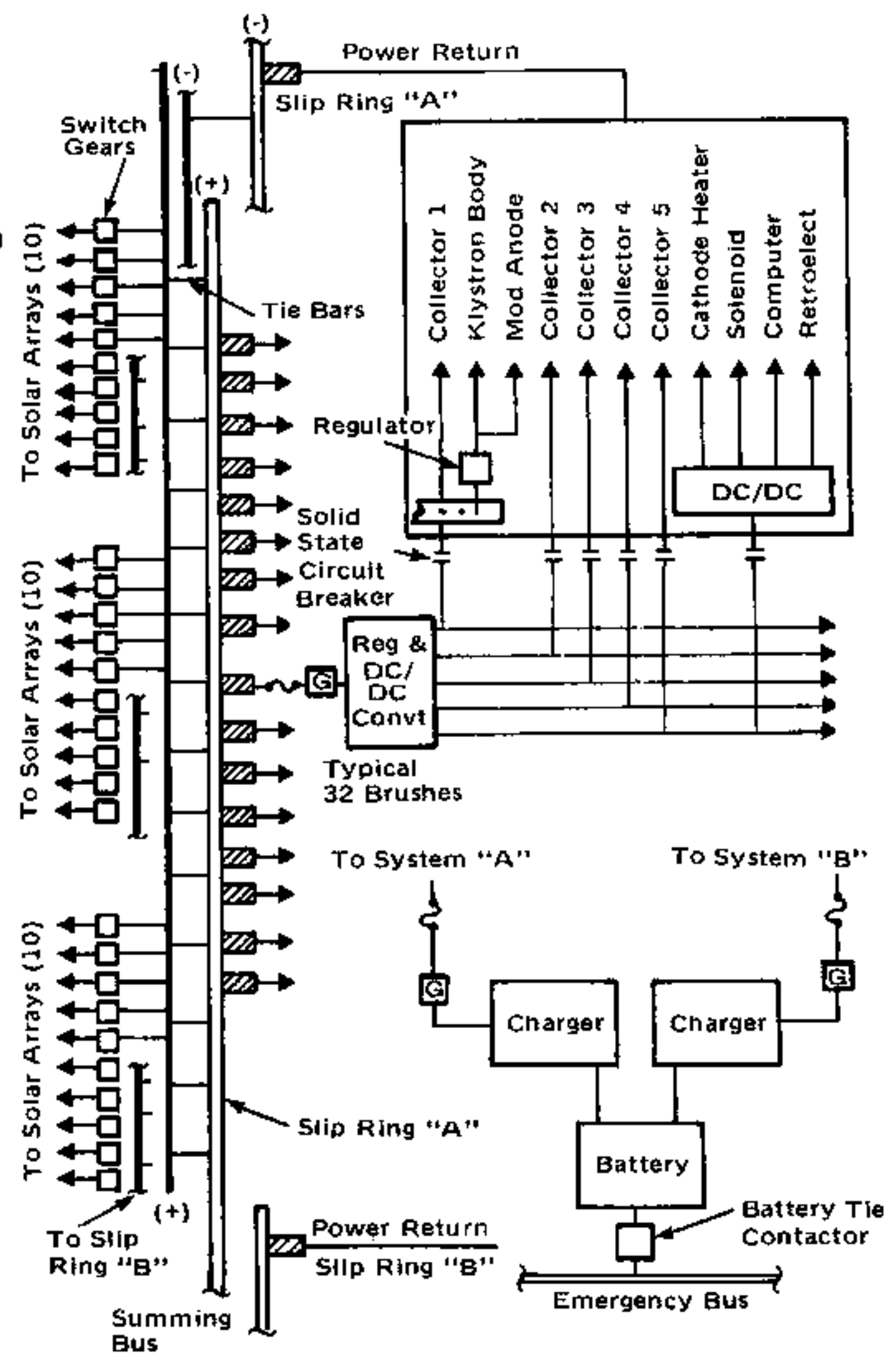

Figure 2. PDS Simplified Block Diagram

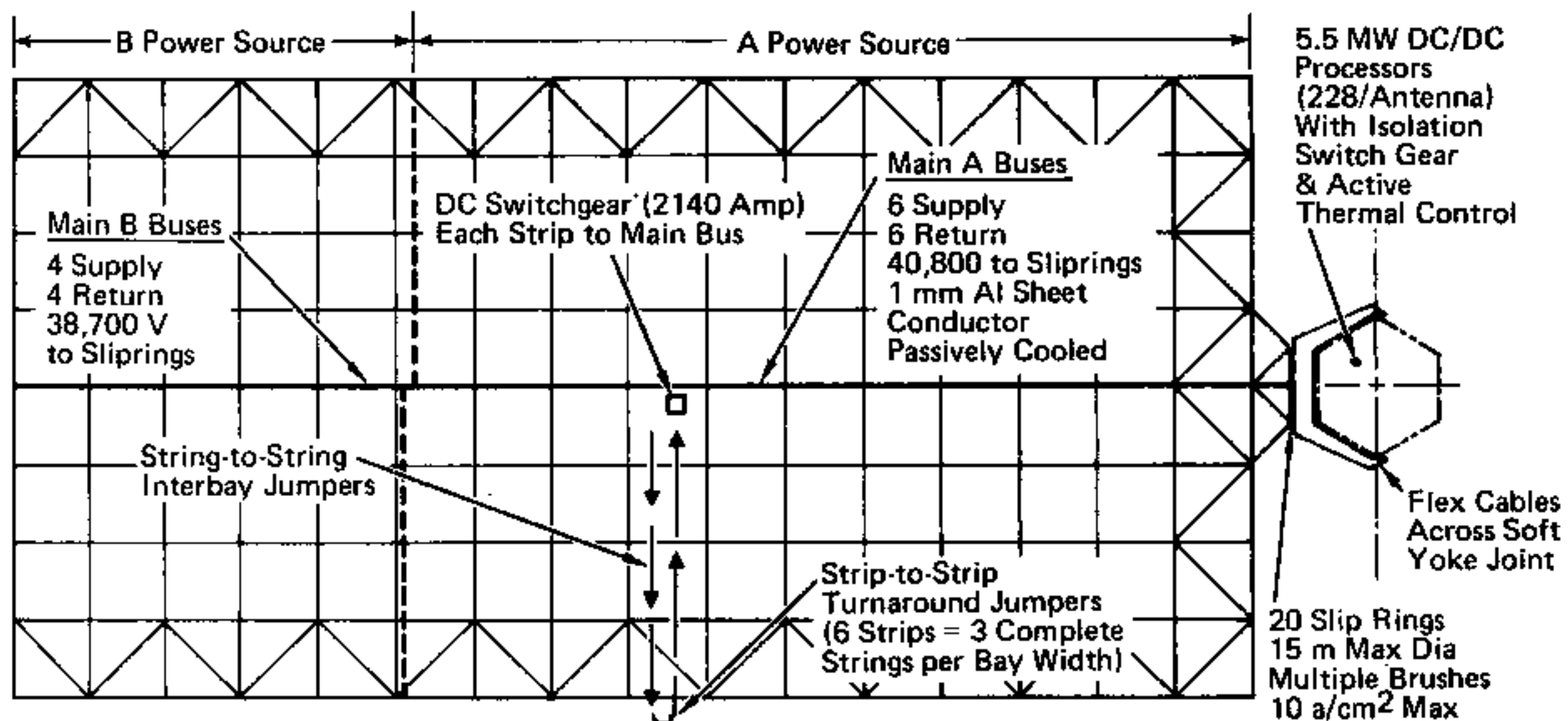

Figure 3. Multiple Bus SPS Power Distribution (Si Cells)

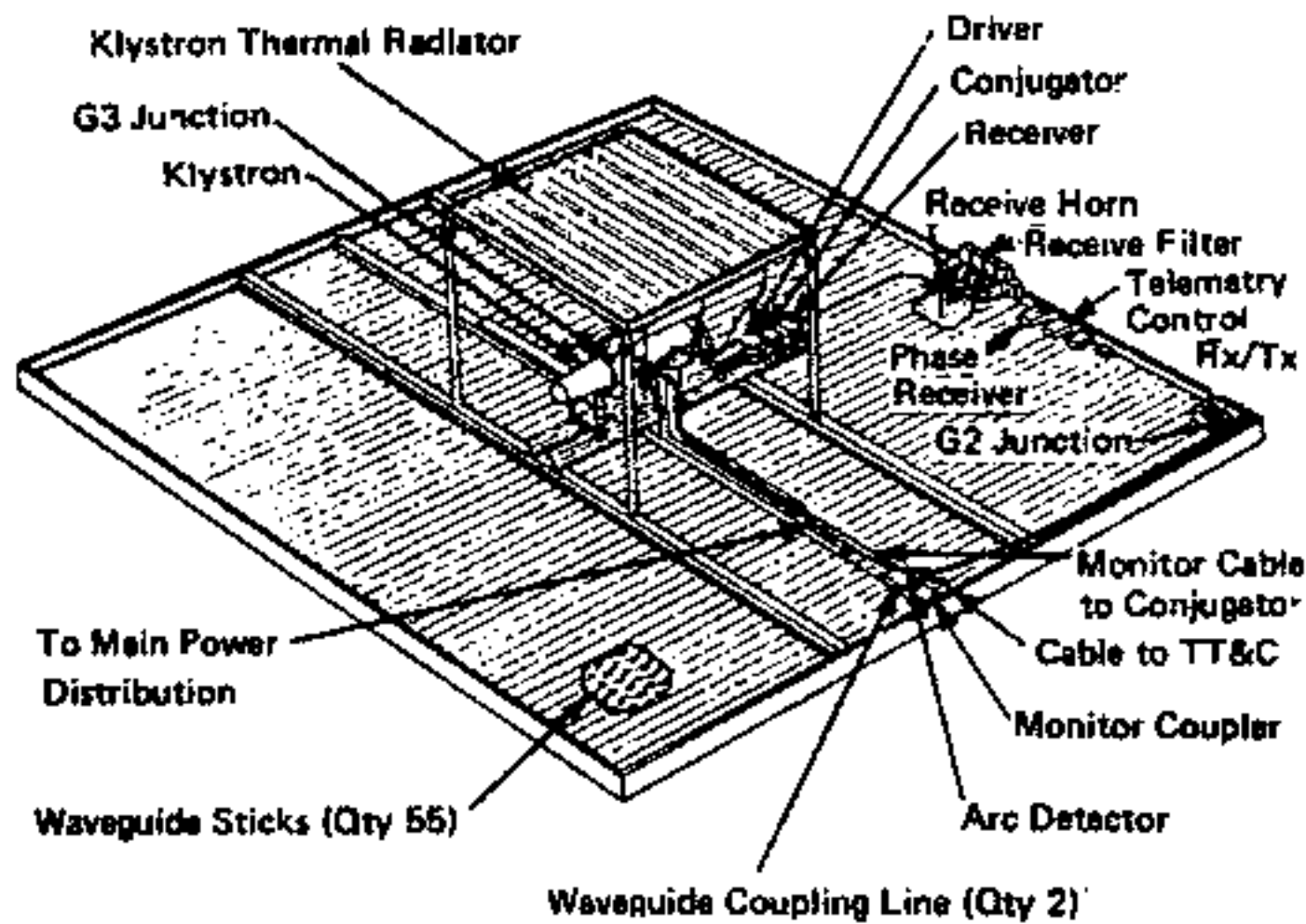

Figure 5. Mechanical Layout of typical Klystron Module

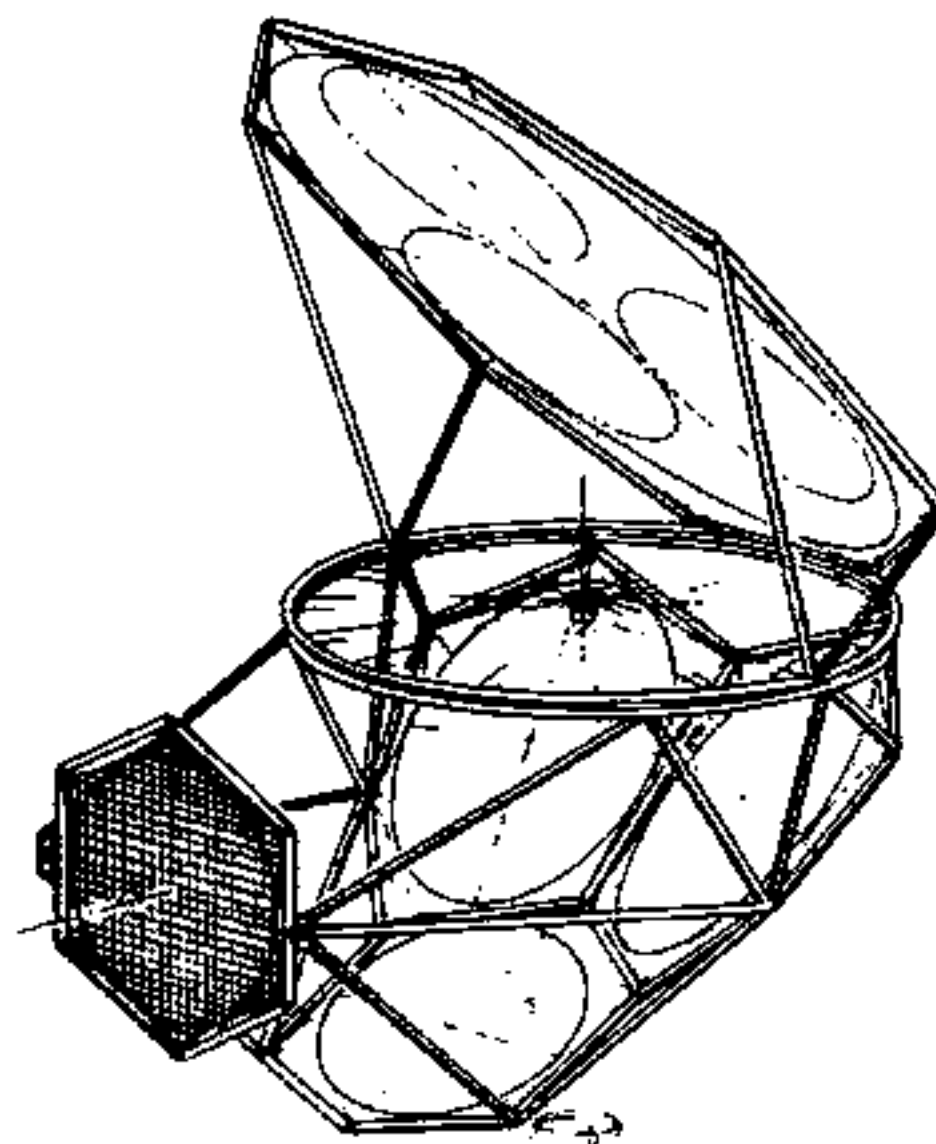

Figure 6. Sandwich Concept

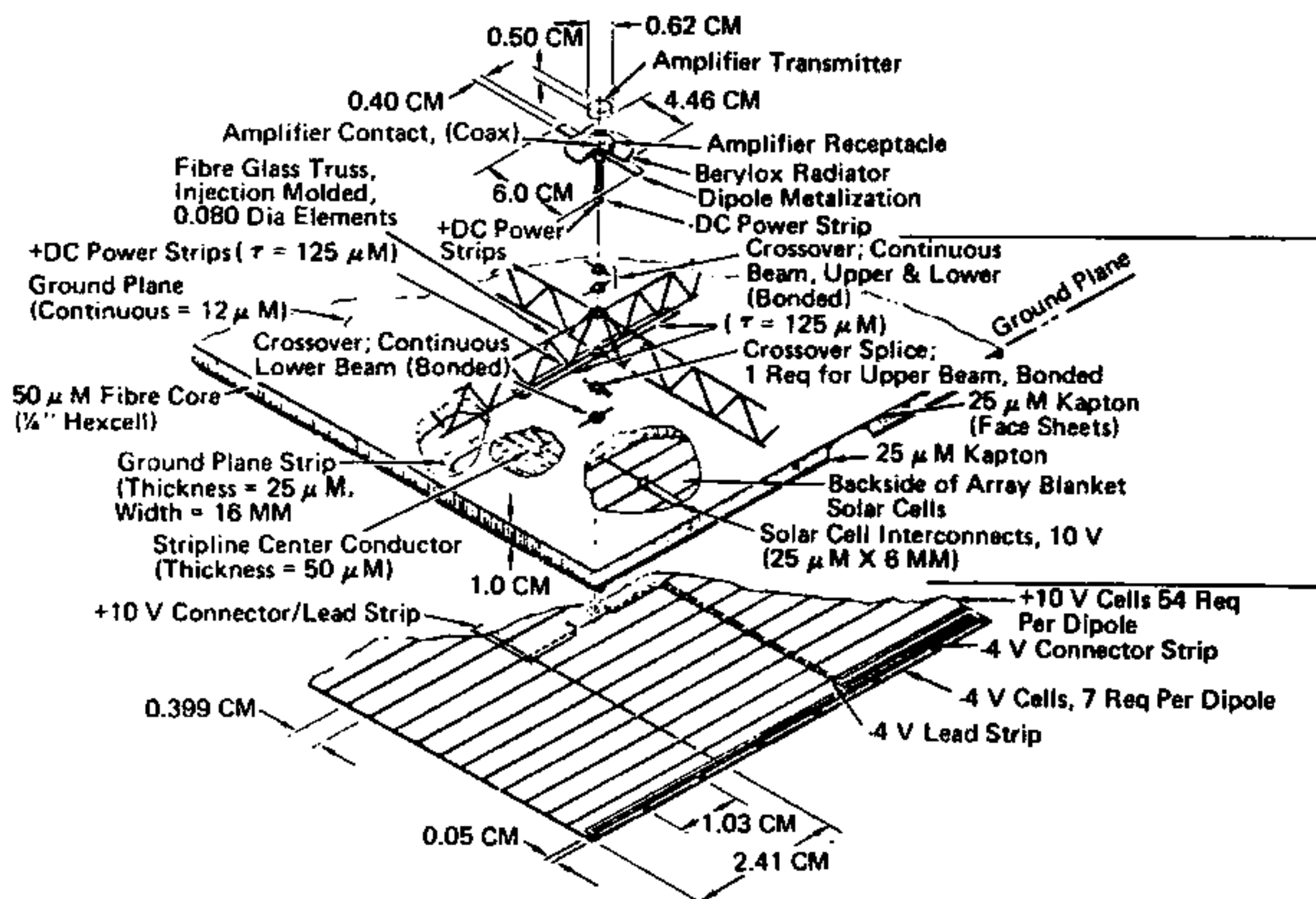

Figure 7. Sandwich Antenna Dipole

provide +10 volts (54 required per dipole). A special bank of 8 cells mounted across the end of the cell strips provides the -4 volts. Structure (truss and honeycomb) assembly details are shown with the details of the dipole radiative element. This cross-section is a typical element of the antenna as provided 7.8 cm on center throughout the entire antenna, with each device transmitting approximately 4.2 watts to the ground. The power distribution for the sandwich concept is an integral part of the RF design.

A Boeing antenna-mounted power module concept in which low-loss combining is achieved to operate the subarray at approximately 5.5 kV is shown in Figure 7. Experiments have indicated that very low losses result when combining the output of 4 solid-state power amplifiers. A subarray would consist of 20,737 modules, four phase control receivers, one for each 5- by 5-meter subsection of the

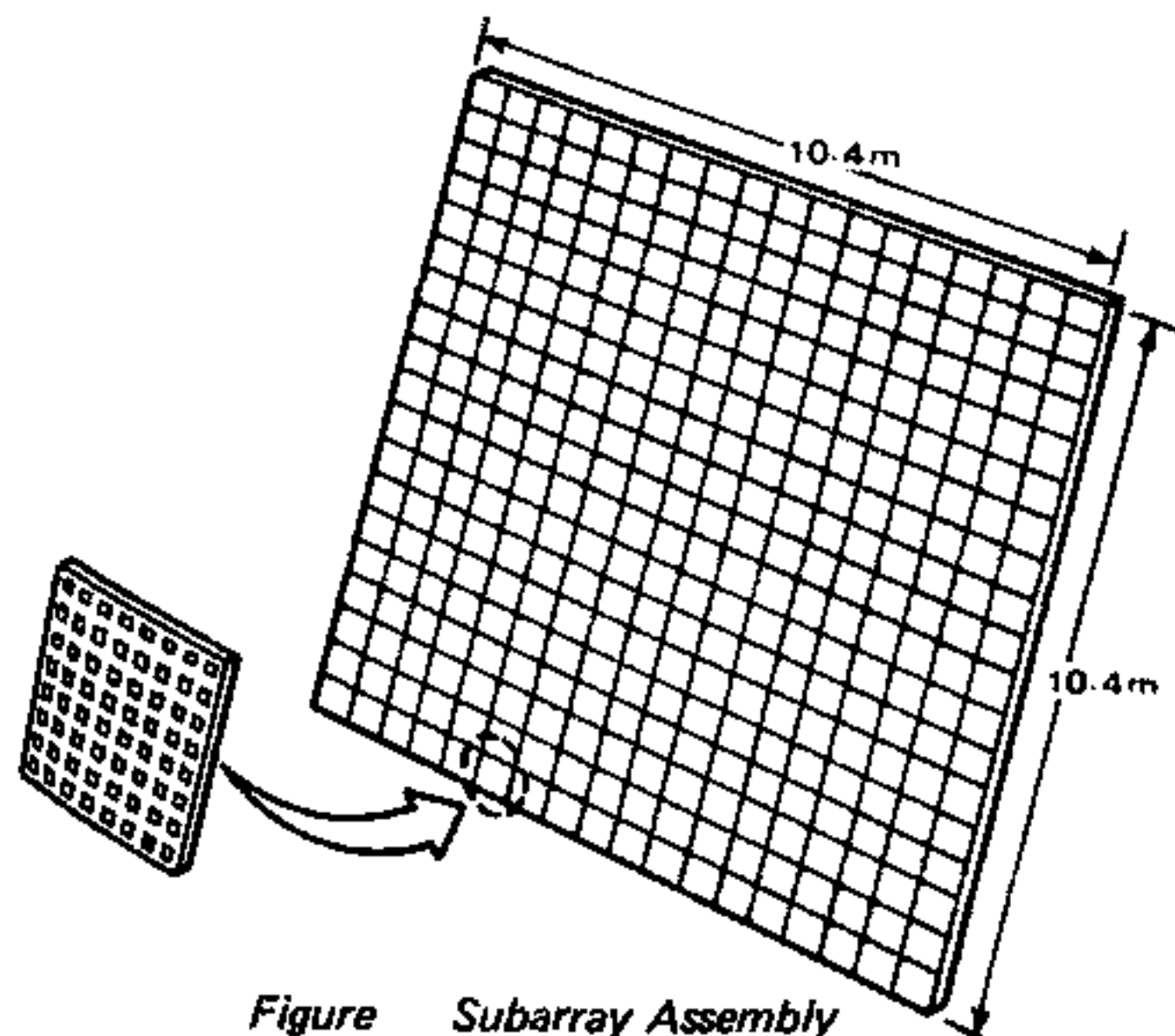

Figure 7. Subarray Assembly

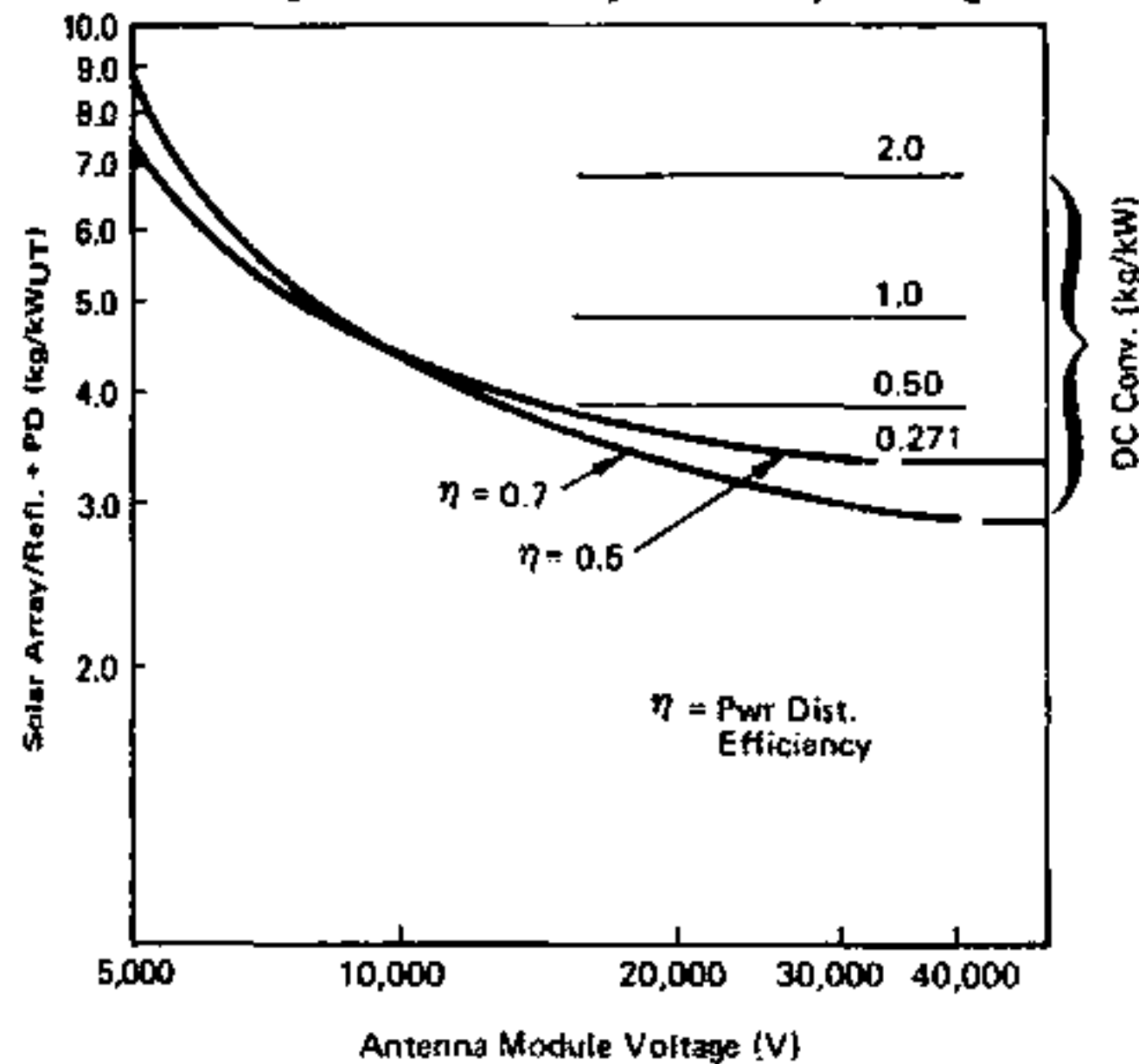

Figure 9. Antenna Module Voltage Crossover (Without dc Converters)

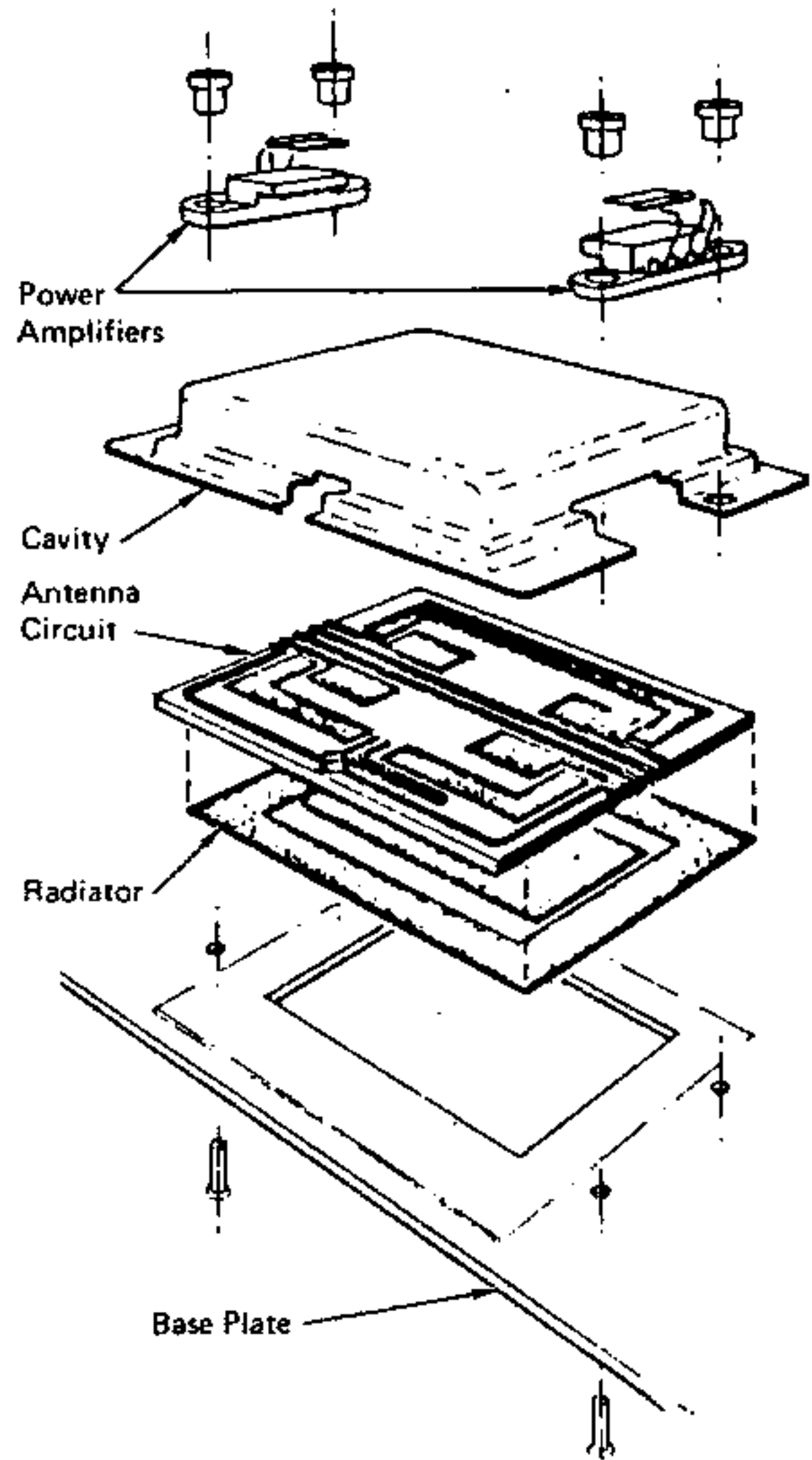

Figure 8. Solid-State Combiner Radiator Module

subarray. The main features of the combiner radiator module are illustrated in Figure 8. The modules would be integrated into any antenna panel of 8 modules. Each module radiates about 30 watts of linearly polarized RF power. This concept is a more direct substitution for klystrons and can be adapted to the SPS configurations shown in Figures 1 and 3.

Antenna module cable weight is very sensitive to the amplifier voltage up to about 500 Vdc. It was determined that at a voltage of about 500 Vdc this impact is negligible. Antenna module voltage cross-over (without dc converters) is shown in Figure 9; (i.e., the voltage level at which power transmission would have to be delivered and utilized without dc converters). The specific mass of the dc converter is shown as a parameter. Westinghouse Electric Corp. (Advanced Energy Systems Division, Pittsburgh, PA) performed a subcontracted study for Rockwell and concluded that the SPS 1990 goals for high-voltage dc converters (specific weight goal of 0.197 kg/kW and efficiency goal of 96% for klystrons and 0.271 kg/kW and 92% for solid state) appear to be reasonable.⁴

High-voltage transmission is desirable because of the large solar array and corresponding conductor masses (with exception of sandwich solid-state concept). High efficiency and lightweight dc converters become very important to the SPS (both the satellite and orbit transfer vehicle).

⁴Satellite Power System Power Distribution Study. Westinghouse Electric Corp., M9L8GDS-897407D (March 10, 1980).

SATELLITE POWER SYSTEM OPERATIONS

by Francis L. Pugh

IBM Federal Systems Division

Westlake Village, CA

and A.I. Gordon

Space Operations & Satellite Systems Division, Rockwell International

Seal Beach, CA

A projection of the electrical energy demands over the next 30 to 50 years, coupled with reasonable assessments of known or developable energy sources, indicates that a shortage of electrical energy will occur about the turn of the century. Recognizing the criticality of such a shortage, the Department of Energy (DOE) is currently evaluating alternative power generation concepts. One of these candidate concepts is the Satellite Power System (Figure 1).

The power levels considered during the evaluation of the various satellite systems have ranged from 5 to 10 GW. It is apparent that, with this power level, both the satellite and the rectenna must be very large and encompass a large number of complex operational system activities.

Major elements of the Satellite Power System (SPS) consist of a power satellite placed in a geosynchronous equatorial orbit, and a dedicated ground receiving station (GRS) located at a selected site within the continental United States. The nominal power output of the SPS is established at 5 gigawatts (5 million kilowatts) although, because of various system constraints or losses, it may actually produce between 4 and 5 gigawatts.

The GRS and utility interfaces are designed to emulate existing power generation sources, such as present hydroelectric, thermal, or nuclear plants. The fact that the electrical power is first converted from solar sources in space is irrelevant in this approach. The rectenna receiving panels, which cover 30 to 40 square miles, are treated as if they are merely another type of power source.

The SPS has at least three distinct time phases of operations. These are (1) test and evaluation (T&E), (2) initial operational capability (IOC) including startup, and (3) final operational capability (FOC). As the SPS capability passes through these phases, there will be an evolutionary change from semi-automated control and validation to a more automated system.

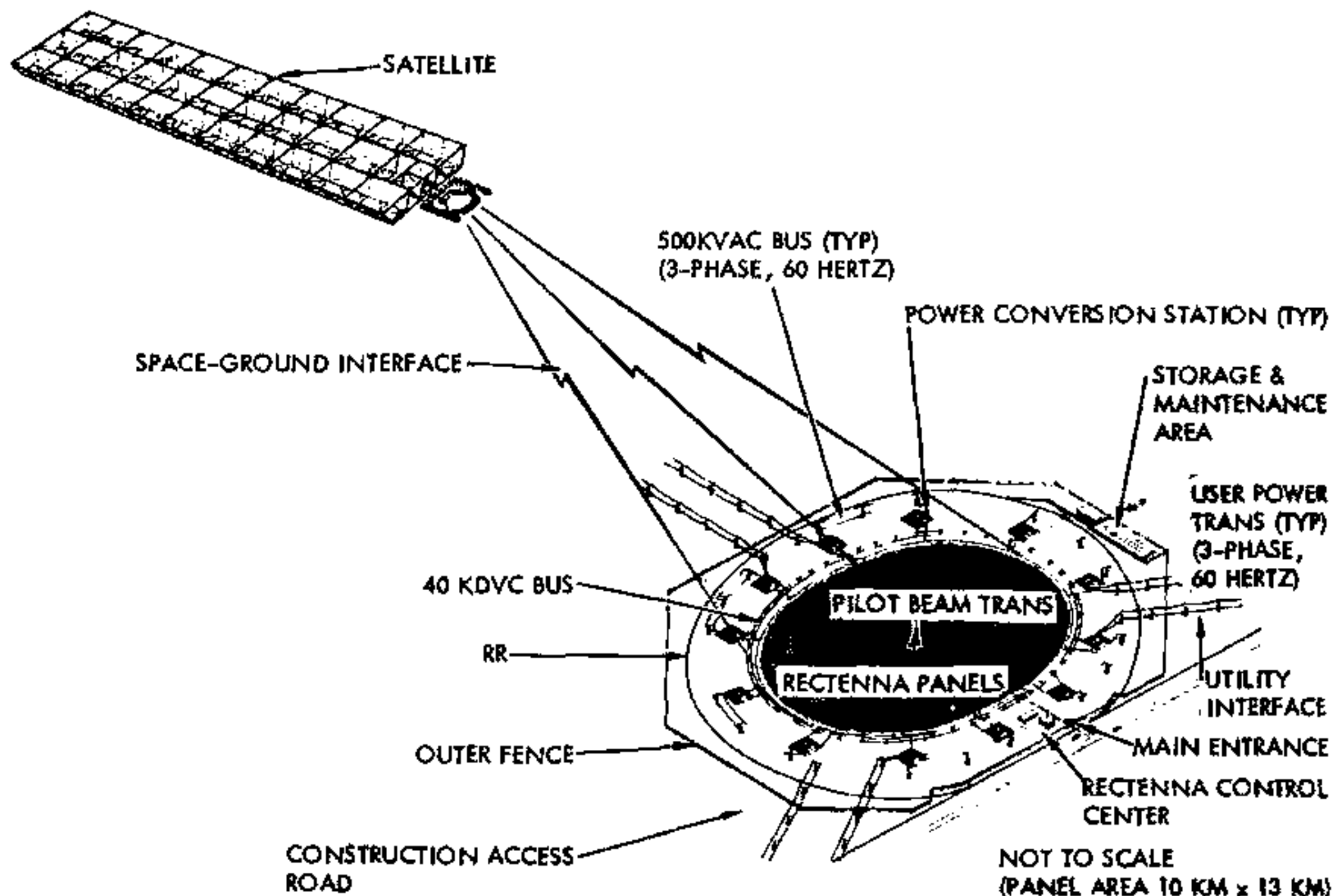

Figure 1 Satellite Power System

This functional analysis is constrained to startup and nominal operations because of the limited study time and because of the limited subsystem and system data available. The satellite functions identified and evaluated primarily address the major subsystems to generate and transfer the energy obtained during the primary satellite mission.

The startup phase will be used to illustrate the basic activities that may occur during any one of the three operational phases.

Startup control functions for satellite power production and transmission are sequenced automatically by the spaceborne and ground computers. An example of the antenna startup sequence and related control issues is shown in Figures 2 and 3. This analysis identified concerns regarding activation, stabilization, and control response times.

DISTRIBUTE POWER TO KLYSTRONS

- CLOSE ANTENNA RING BRUSH SWITCHGEARS
- POWER UP CENTRAL CONVERTERS
 - 5 OUTPUT VOLTAGES TO KLYSTRONS
 - 60+ KW POWER TO EACH
- CLOSE 5-POLE SWITCHGEARS TO PRIMARY/SECONDARY BUSES
- PLACE REDUNDANT SWITCHGEARS ON STANDBY
- SEQUENTIALLY CLOSE 5-POLE SWITCHGEARS TO:
 - MECHANICAL MODULES
 - POWER MODULES (INDIVIDUAL KLYSTRONS)
- STABILIZE POWER TRANSMISSION TO EARTH
- MAINTAIN BATTERIES 100% CHARGED
- ECLIPSES: OPEN MAIN POWER BUSES
 - SHUT DOWN POWER MODULES/ENERGIZE BATTERY BUS
 - MAINTAIN KLYSTRON TEMPERATURES
 - UPDATE ORBIT PREDICTIONS AND SCHEDULES
 - MAINTAIN RETRO-ELECTRONICS ON STANDBY

Figure 2. Satellite Operations – Startup (Antenna)

ACTIVATION & STABILIZATION TIMES

- REPETITIVE STATIONKEEPING & BORESIGHT OPERATIONS
- STATUS & CONTROL SEQUENCING THROUGH 100,000+ POINTS
- THERMAL STABILIZATION OF KLYSTRONS
- INITIATION & STABILIZATION OF FINE POINTING

STARTUP TIME SEQUENCES COULD BECOME VERY LONG

POSSIBLE IMPACT TO SPS CONTROL RESPONSE REQUIREMENTS

- STARTUP/SHUTDOWN DUE TO ECLIPSES
- EMERGENCY RESPONSES AND RECOVERY
- RESPONSE TO UTILITY POWER LOADINGS

Figure 3. Startup Control Issues

The ground control center does not play a direct role unless the onboard control system fails. In this event, direct ground control would be limited to performing emergency shutdown using separate and redundant control links in critical systems' areas.

The rectenna control center (Figure 4) would monitor startup sequencing to provide any necessary ground support to the satellite. This includes antenna boresighting, pilot beam control and initiation of power reception, conversion, and distribution to the utility customer interfaces. Special coordination functions may be needed from the ground center to avoid power surges and to provide load leveling. Emergency shutdown of satellite operations also may be required if a major ground system failure occurs.

During the operational phase the satellite and GRS have reached stabilized power conversion and transmission to the utility network. The rectenna control center will receive periodic updates of scheduled power requirements from the utility area control center (Figure 5). These load schedules are translated by the ground center into satellite power output schedules which take into account RF transmission, rectenna conversion, dc-to-dc/ac conversion efficiencies, and related factors. This scheduling facilitates matching of generated power to load levels.

If for some reason the entire utility network or a dedicated customer drops off the line, the SPS power output may be shut down, adjusted, or switched to other loads. The ground center must accommodate these and other contingencies such as problems in rectenna dc-to-dc/ac conversion and distribution. Emergency shutdowns or load adjustments require authenticated commands, rather than enabling messages, to be transmitted to the satellite.

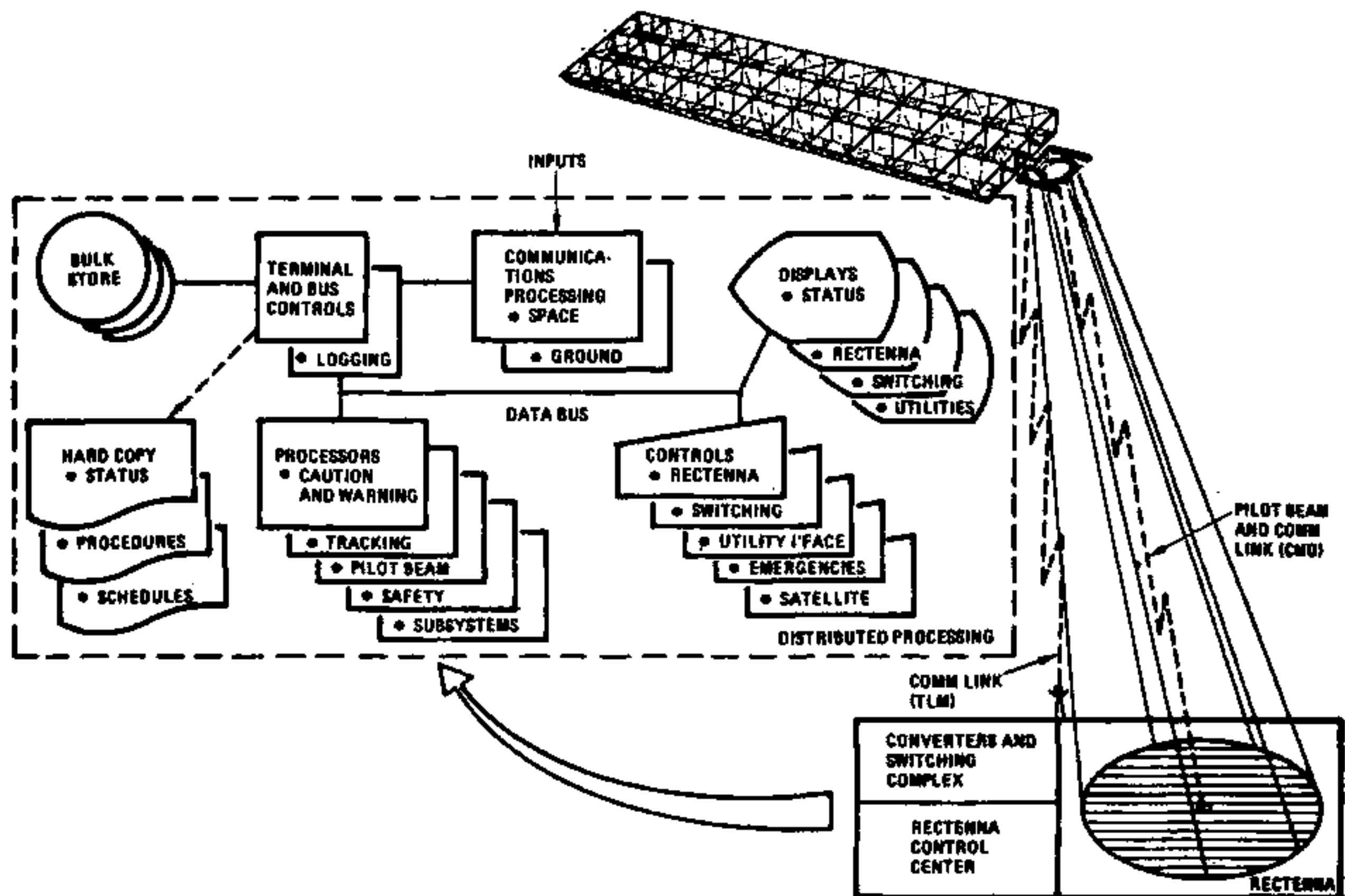

Figure 4. Rectenna Control Center Concept

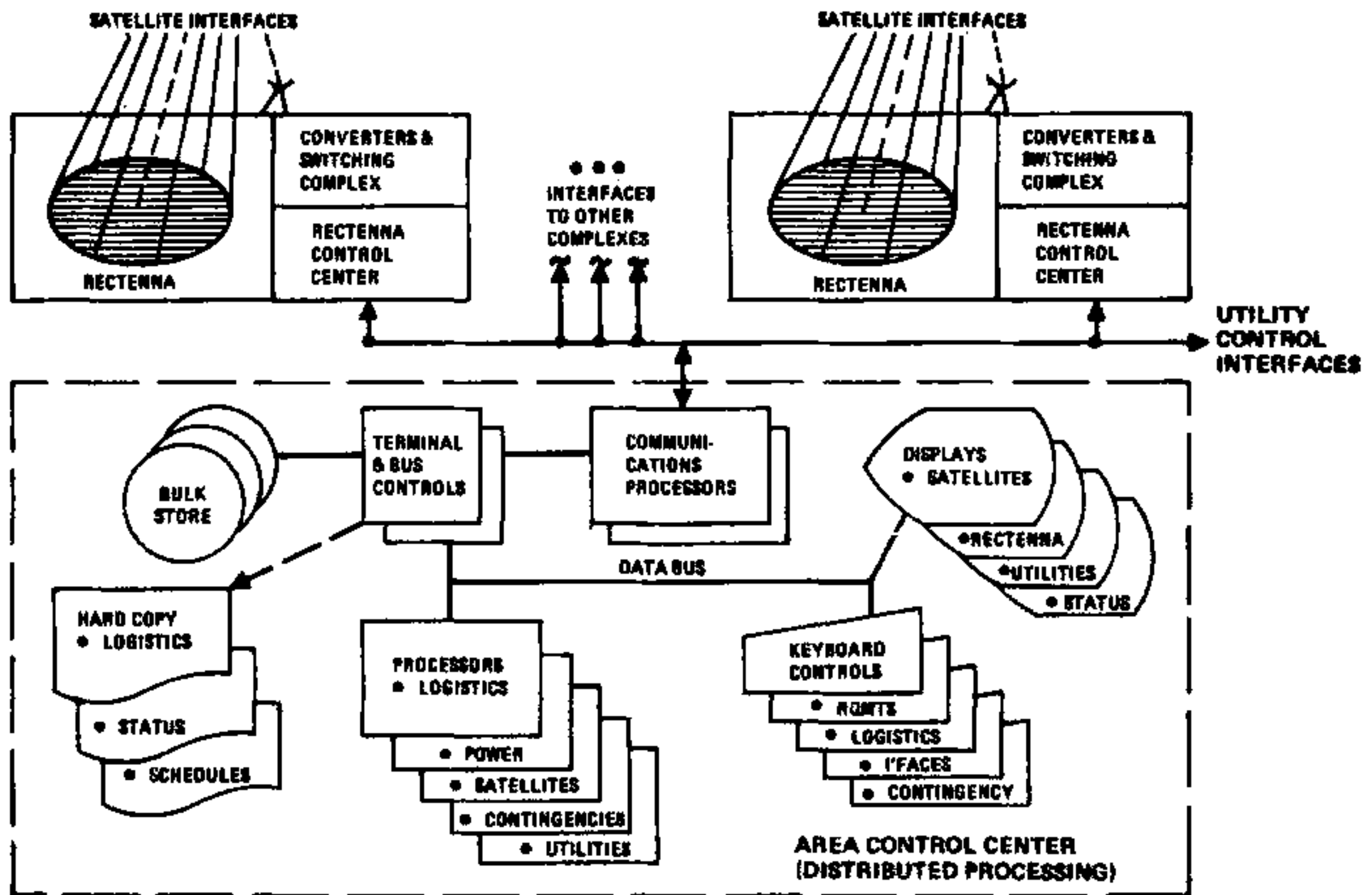

Figure 5. Area Control Center Concept

It is uncertain whether an area center is required to coordinate several rectenna sites. It may be that coordination is needed only by each rectenna with its respective utility network center. Separate rectenna and area centers might be eliminated if they could be integrated into a single location. Design trade studies are needed to investigate these possibilities.

A number of communications implications have been drawn. Continuous contact must be maintained between the satellite and ground control center. This includes bi-directional voice, data, video, and command links. In addition, the uplink pilot beams from the rectenna are crucial to acquisition and fine pointing. The high EMI environment in the near vicinity of the satellite imposes difficult conditions for communications.

From the analysis it has been concluded that there are no operational "show stoppers." The basic need is to identify in greater detail the operating characteristics and timelines of various satellite and ground system equipment with emphasis on activation and stabilization times, intervals, and sequences.

All large space structures in Earth orbit are immersed in a very tenuous ionized "gas". This ionized "gas" (called plasma) exists everywhere in space. Although so tenuous as to be completely insignificant for most purposes to date, this plasma provides a source of electric current carriers which can become very significant for large structures and/or high voltages. Adequate consideration of such effects should be included during design of the SPS.

There have been two primary problems identified to result from plasma interactions; one of concern to operations in geosynchronous orbit (GEO), the other in low orbits (LEO). The two problems are not the same. Spacecraft charging has become widely recognized as a problem, particularly for communications satellites operating in GEO. The very thin ($0.1-10/\text{cc}$) thermal plasmas at GEO are insufficient to bleed off voltage buildups ($>10\text{ kv}$) due to higher energy charged particle radiation collected on outer surfaces. Resulting differential charging/discharging causes electrical transients, spurious command signals and possible direct overload damage. An extensive NASA/Air Force program has been underway for several years to address this problem (1,2). At lower altitudes, the denser plasmas of the plasmasphere/ionosphere provide sufficient thermal current to limit such charging to a few volts or less. Unfortunately, these thermal plasma currents which solve the (GEO) spacecraft charging problem can become large enough to cause just the opposite problem in LEO.

Ionospheric plasma densities exceeding one million/cc exist around spacecraft in LEO. Operation of large solar arrays at high voltage, for SPS developmental testing or LEO assembly/self-propulsion, could drive substantial leakage currents through this surrounding plasma (Fig. 1). The resulting power loss to these parasitic currents has been observed to exceed solar cell output capability for small (10 cm) test objects in the laboratory. Recent estimates of this effect for large arrays, based on limitation of the leakage currents by formation of space charge limited sheaths around the high voltage surfaces, indicate that such losses should remain within acceptable limits for very large ($>100\text{m}$) arrays (Fig. 2). Large (10m) scale lab tests in simulated LEO plasmas at JSC tend to support these estimates (Fig. 3), but much more detailed work remains to be done (3).

Several other plasma effects have been observed which may become more important as design considerations for SPS than the basic parasitic plasma currents. Focusing of the currents collected within a specific electrostatic "lens" configuration produced by the sheath fields surrounding a high voltage panel has been observed to produce local concentrations of current which could potentially overload or damage a small area of cells within a larger string, even though the average current density "leaking" from the plasma to the entire array is less than the design limits. Fig. 4 is a tracing of relative current density contours observed on the face of a simulated solar array operating at $-2,000\text{V}$ in an argon plasma of density about $10^5/\text{cc}$. The panel area included in the figure is about 1 meter by 2 meters, at one end of the $1\times 10\text{m}$ panel. The total current flow measured to the entire panel indicated an average current density of $1.0\text{ ma}/\text{m}^2$ ($0.1\text{ }\mu\text{amp}/\text{cm}^2$). Most of this current was concentrated within the roughly triangular region within the contours shown; with contour level #1 containing local current densities roughly $0.1\text{ }\mu\text{amp}/\text{cm}^2$, increasing linearly to more than $0.8\text{ }\mu\text{amp}/\text{cm}^2$ within contour #8. Currents outside contour level 1 dropped sharply, to probably less than $0.01\text{ }\mu\text{amp}/\text{cm}^2$ throughout region 0.

Early work at Boeing (4) showed that thin films of insulation probably would not be effective in reducing plasma current leakage, due to intense flow of currents through even a small number of pinholes in the insulation (Fig. 5). Examination of the sheath model of plasma interaction in Fig. 6 shows that, above a threshold voltage where sheath dimensions equal or exceed the spacing between exposed conductors (bare interconnects or pinholes), very little reduction of total current collected should be expected from insulation of even most of the panel surface. This is probably related to the "snap-over" phenomena reported by NASA-LeRC (5). Tests were done at JSC using a 1X10m stainless steel panel, first operated at voltages to -3,000V with no insulation, then operated in identical ($10^5/\text{cc}$) plasma densities with >90% of the total surface area insulated by application of mylar tape. Results are shown in Fig 7. Not only was the insulation not effective in reducing current leakage at voltages over 100V, but it also caused increased currents and transient "arcing" to the plasma that prevented measurement of currents for voltages in excess of 200V.

Such transient increases in current above the equilibrium space charge limiting values have frequently been observed. These "arcs" have been observed as bright flash points near solar cell interconnects at LeRC and from most dielectric surfaces within the high voltage plasma sheath volume surrounding the 10 meter panels tested at JSC. Current densities greatly in excess of even bipolar space charge limited values are observed. The arcing from large panels has been reduced by making exposed surfaces conductive, while adding large areas of insulation was observed to reduce the on-set voltage for arcing from -3,000V to -250V for the otherwise unaltered panel used in Fig. 7 test. The "arcing" mechanism is not understood at this time. It is clearly of importance to determine reliable criteria to avoid this phenomena on operational space systems. The needed solution may well come from existing plasma and materials investigations directed toward the GEO spacecraft charging problem. Although LEO plasma densities eliminate charging for most passive spacecraft surfaces, in the case of high voltage sheaths exclusion of the repelled species and acceleration of the attracted current carriers results in a local environment within the sheath similar to GEO during an intense storm. These sheaths may occur around known high voltage surfaces such as solar arrays, or even passive surfaces of large structures which acquire magnetically induced voltages due to orbital velocity.

An interesting point is implied regarding the high voltage (Klystron, etc) vs. low voltage (solidstate microwave transmitter) options for SPS. Although avoidance of the "arcing" problem may appear to be a point in favor of selecting the low voltage option, just the opposite could be true. Physical damage to the "arcing" surface is very rare. The major design problems posed would seem to be increased average power loss and induced electrical transients. The low voltage devices may be much more susceptible to these transients than high voltage tubes, etc. Since arcing may occur due to other causes (induced voltages) than actual high operating voltage of the solar arrays, a high voltage system could well be less vulnerable to arcing problems.

Development of adequate computational tools (similar to the NASCAP program now available for GEO spacecraft charging effects) for use in design calculations is needed in order to proceed with reasonable confidence in the design of higher voltage power systems for operation in LEO. Criteria are also needed to define ground and flight test requirements to validate the proposed design cal-

ulation programs, as well as to check for the existence of any plasma instability or interaction modes that might be overlooked or scaled improperly in the general models.

References

1. Pike, C.P. and Lovell, R.R., eds.; Proceedings of the Spacecraft Charging Technology Conference, NASA TM-73573, 1977.
2. Spacecraft Charging Technology - 1978, NASA CP-2071, 1979.
3. McCoy, J.E. and Konradi, A.; "Sheath Effects Observed on a 10 meter High Voltage Panel in Simulated Low Earth Orbit Plasma", in Spacecraft Charging Technology-1978, NASA CP-2071, 1979.
4. Kennerud, K.L.; "High Voltage Solar Array Experiments", NASA CR-121280, 1974.
5. Stevens, N.J. et al, "Investigation of High Voltage Spacecraft System Interactions with Plasma Environments", AIAA Paper 78-672, 1978.

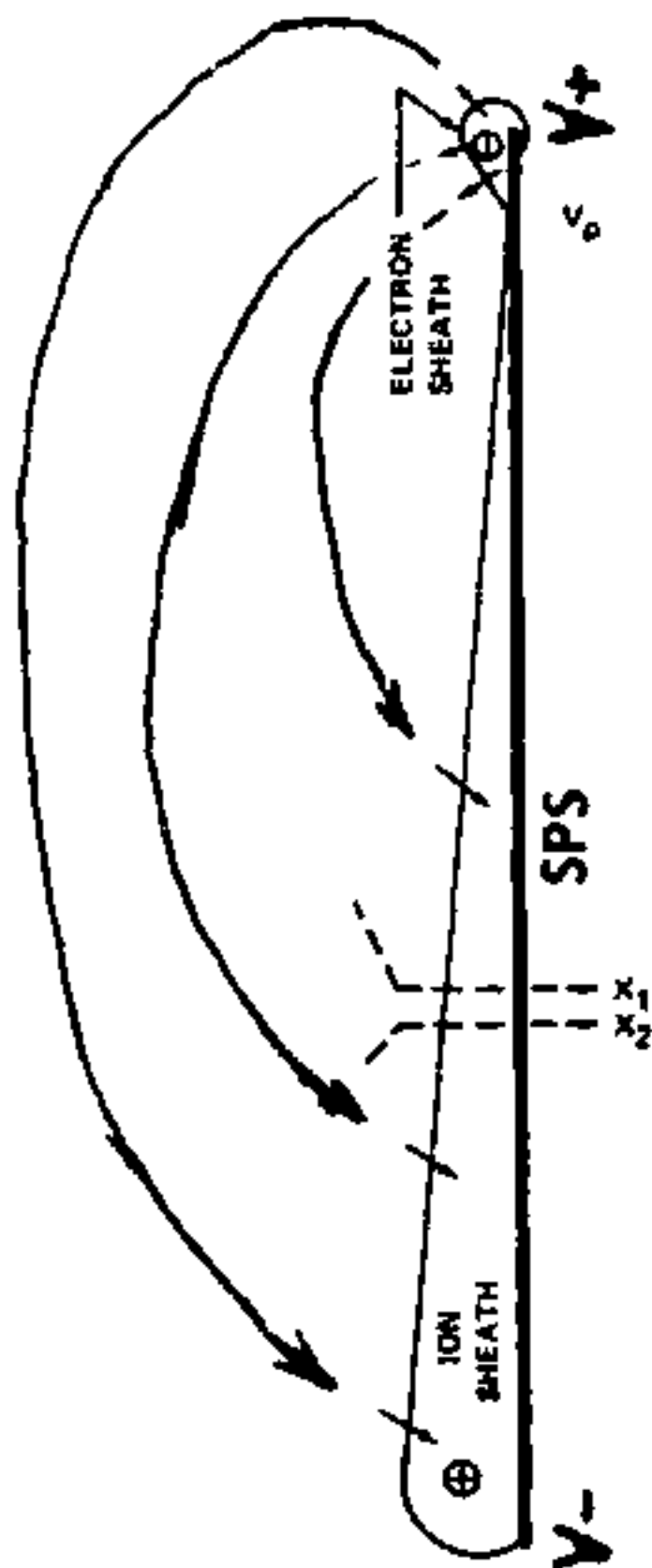

Fig. 1 - SPS Plasma Leakage Current Paths, edge view.

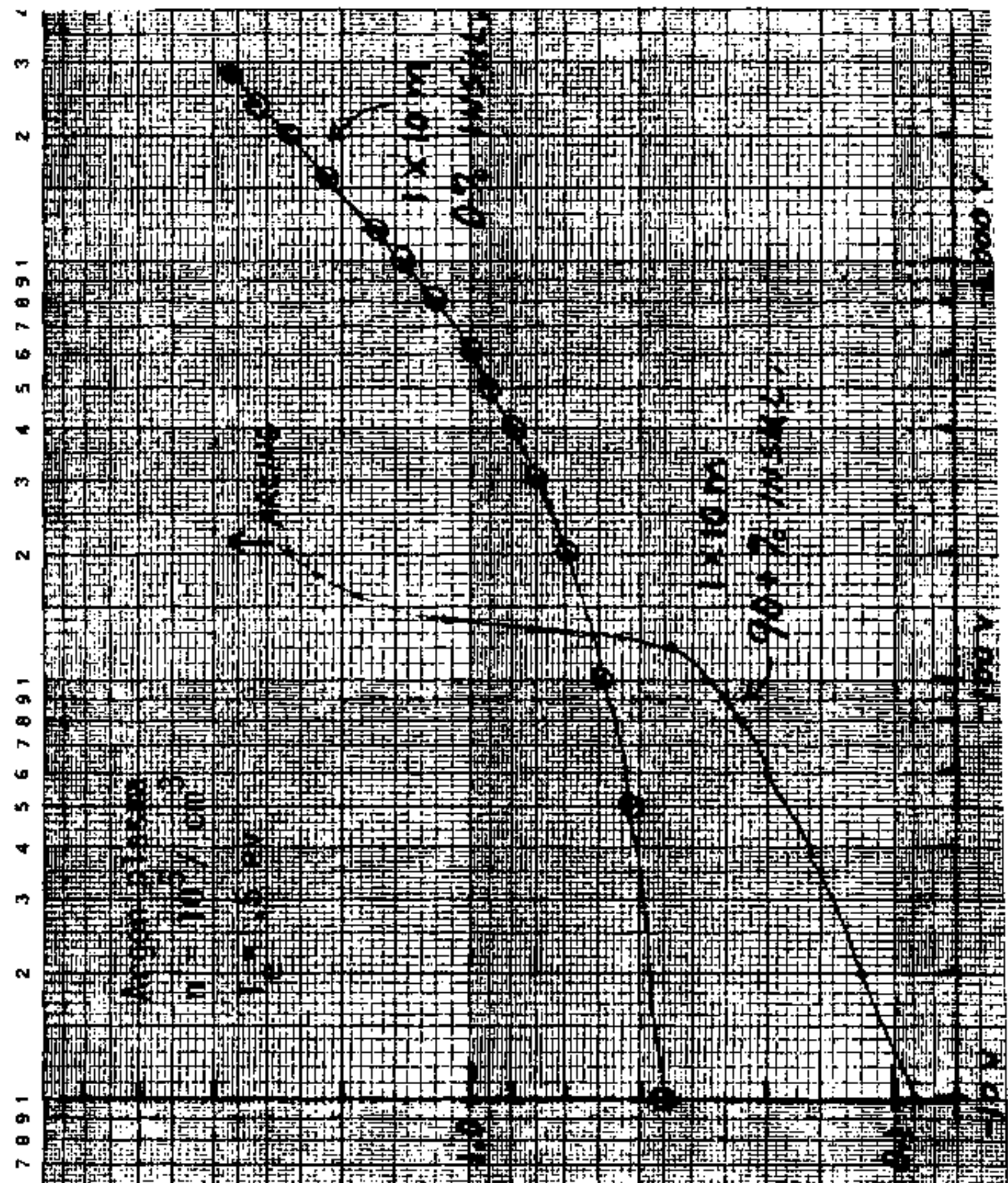

Fig. 7 - Insulated & Noninsulated Panels Leakage current (ma) vs. Bias Voltage Applied.

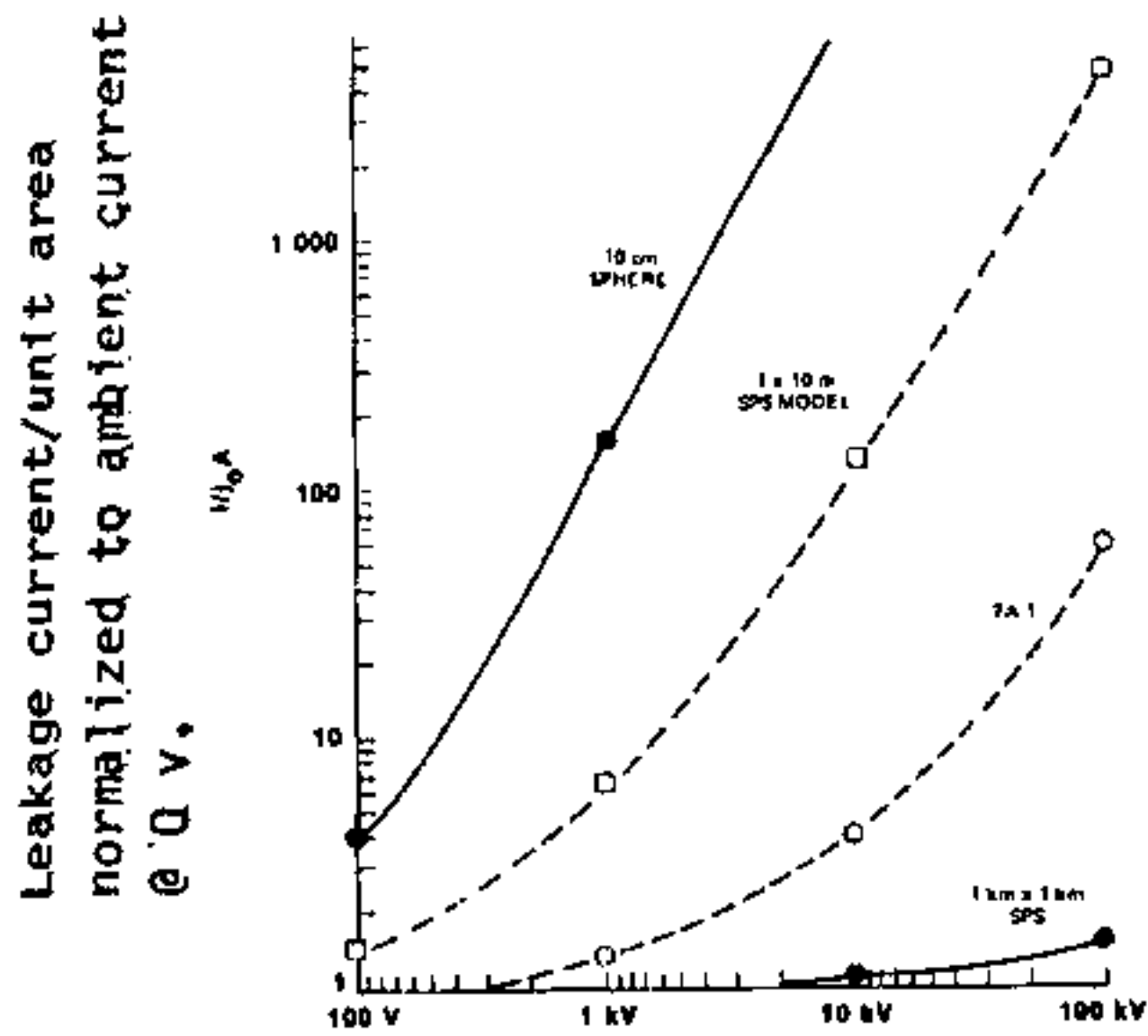

Fig. 2 - Est. size dependence @ LEO plasma density relative panel size

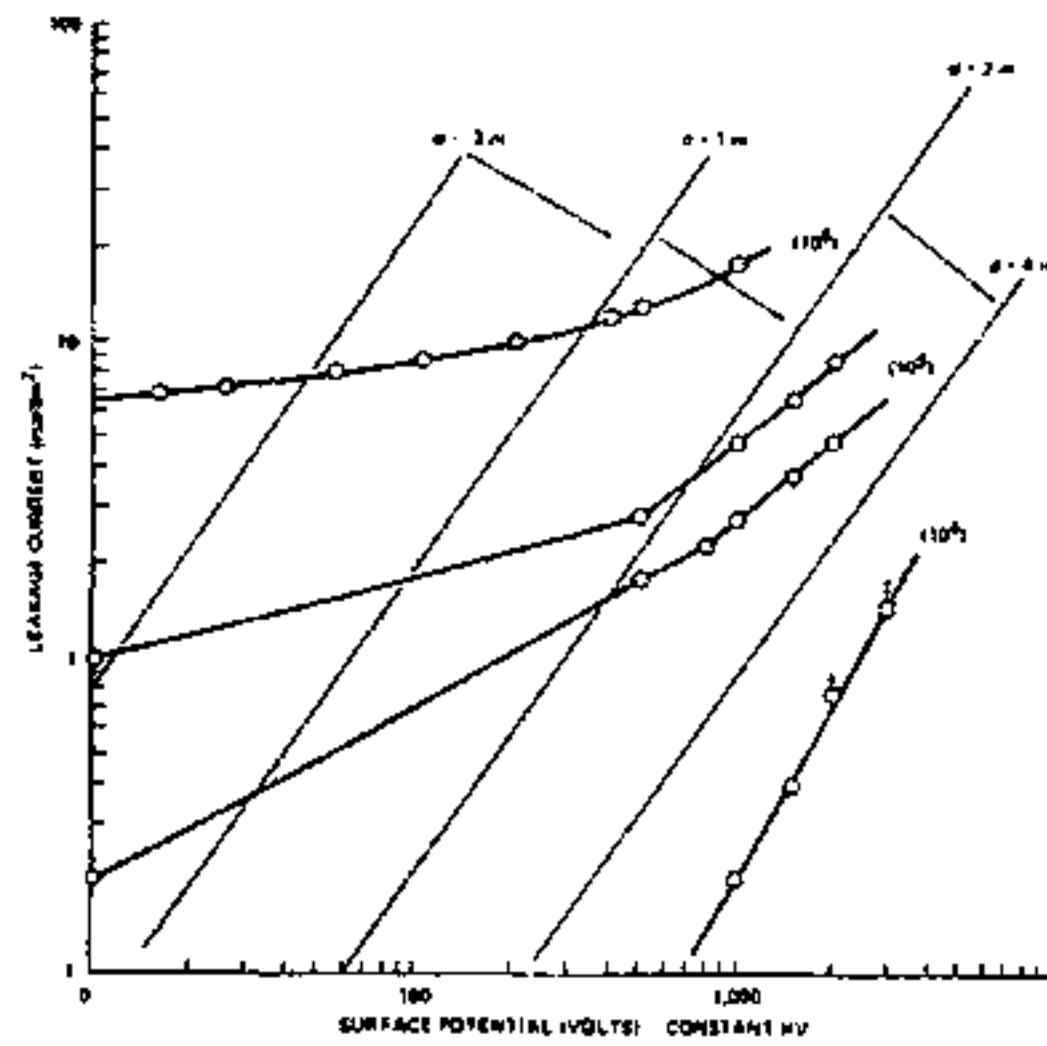

Fig. 3 - Measured leakage at various plasma densities (variation with sheath size relative to 1x10 m panel)

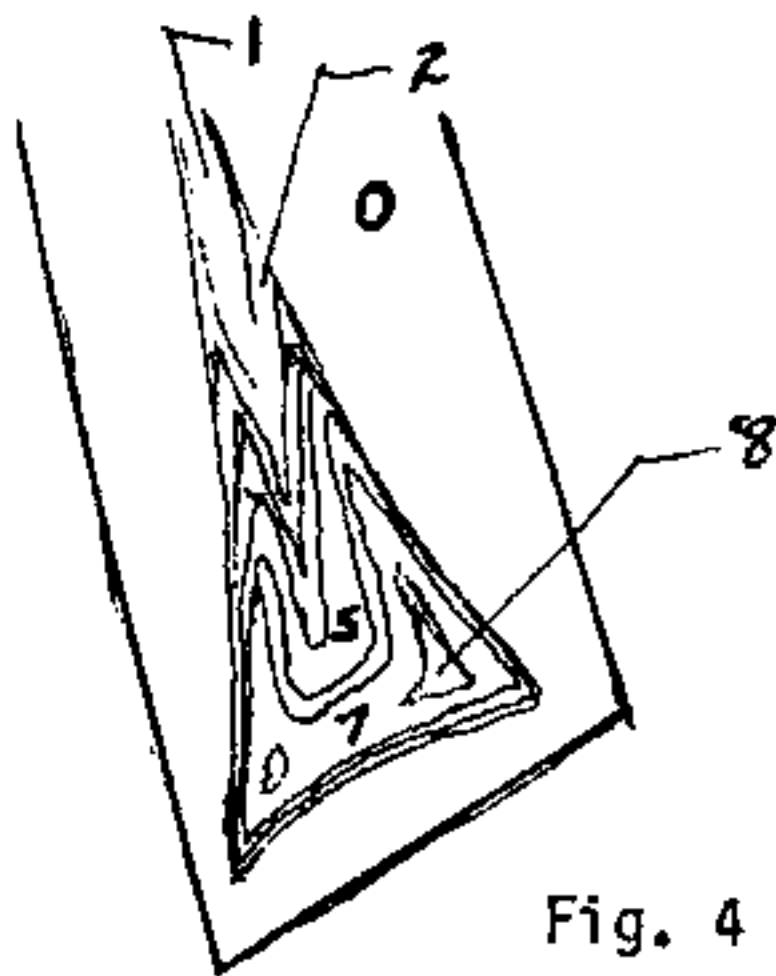

Fig. 4 Surface current density contours.

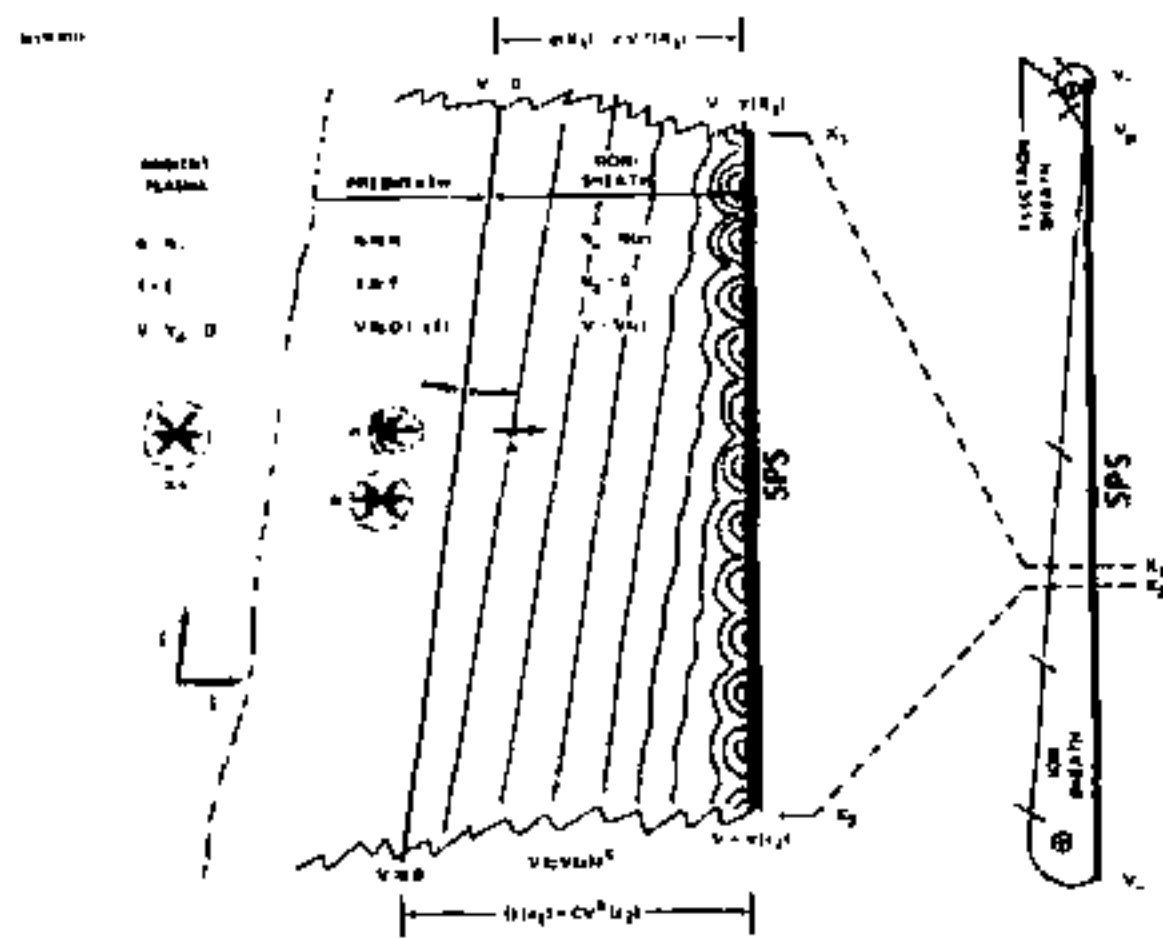

Fig. 6 - Space charge limited sheath-SPS surface dielectric except for small exposed conductors (dark spots).

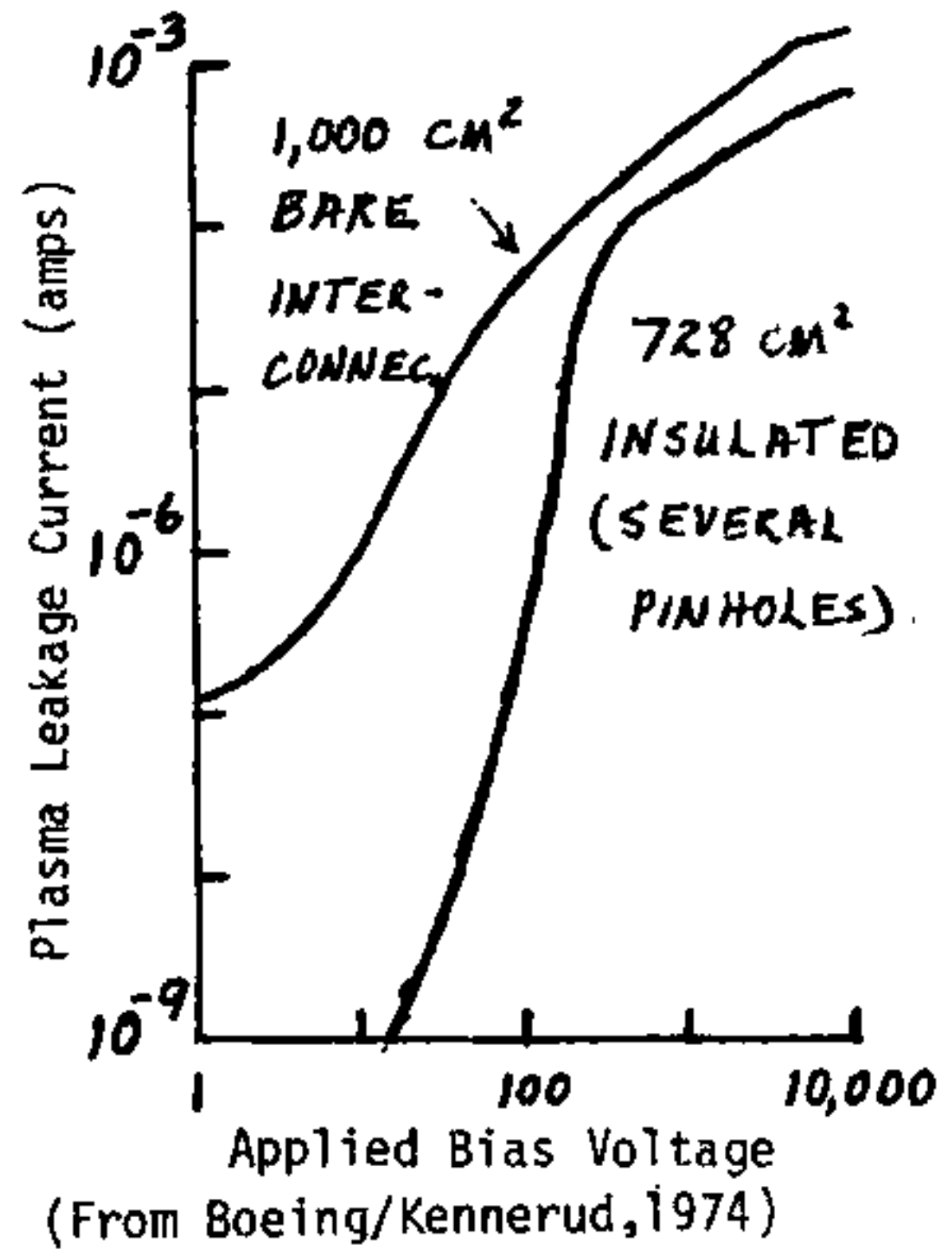

Fig. 5 - Current leakage to completely insulated panel vs solar array with uninsulated interconnects. $N=2 \times 10^3$

SPS POWER MANAGEMENT WORKSHOP SUMMARY

J. Richard Williams
Associate Dean of Engineering
Georgia Institute of Technology
Atlanta, Georgia 30332

The economic practicality of the SPS is greatly affected by the power distribution and management subsystem which directs the electric power output from the solar array modules to the microwave antenna. The efficiency of the power distribution and processing subsystem is also critical through its impact on total SPS weight. The technical feasibility of the SPS will depend in part on the technology readiness of techniques, components and equipment to reliably distribute, process and interrupt hundreds of megawatts of power at tens of thousands of kilovolts. The problems of heat dissipation and prevention of breakdowns due to corona discharge or arc-overs are much more severe in the space environment, because of the absence of the insulating and thermal transfer properties of air.

The total weight of the satellite power system is projected to be between 35-50 million kg for a 5 GW system. This corresponds to a specific power density of around 5 or 6 kg/KW of power delivered to the antenna. However present aerospace power processing technology corresponds to a power density of 10-15 kg/KW. Thus the power processing alone, using present technology, weighs more than the total projected system. In addition, present technology will not perform the functions required. Therefore a major effort must be made in power processing technology development to make future power satellite systems technically feasible and economically viable. One major concern is the successful realization of high power kilovolt protection switches which are wired to protect the transmission tubes within microseconds of normally occurring arcs. Considerable work remains to be done on switchgear, power electronic devices, power transmission elements, and rotary joints.

The geostationary orbit plasma environment presents special hazards to spacecraft designers because of the presence of a dense, high temperature plasma associated with the plasma sheet. Plasma sheet electrons may charge the satellite to high voltages of the order of 10 KV which might cause arcing, shock hazards, and changes in reflective or thermal control surfaces. An associated problem with spacecraft charging is that the ambient space plasma and photoelectrons may enter the solar cell array and form a parasitic load. Both laboratory and flight tests of specific solar cell arrays operating at high voltages will be necessary to determine the extent of this problem and assess corrective measures. The space plasma interaction can have a major impact on the power distribution system. The Marshall Space Flight Center contracted with Rice University for a small study of the space plasma effects on an early Rockwell International SPS design. This study recommended several design modifications and concluded that, with these modifications, SPS operation at GEO was probably possible. However, the study stipulated that laboratory and flight testing of specific solar cell arrays operating at high voltages are necessary for a definitive conclusion.

A power management subsystem is required to provide monitoring of electrical power system parameters, the state and performance of the power distribution network, the operation of power processing components, energy storage and thermal control equipment. It will also take corrective action in case of out-of-tolerance or malfunctions and protect power system elements against destructive overloads and ensure safe access for maintenance operators.

The working group on power distribution and management was directed by Arthur Schoenfeld of TRW.

MICROWAVE HEALTH AND ECOLOGICAL EFFECTS OVERVIEW

Daniel F. Cahill

Exp. Biol. Div., U.S. Env. Protection Agency, Res. Triangle Park, NC 27711

The microwave exposure scenarios associated with the current SPS Reference Design will be reviewed. Within this context, the evolution of the Microwave Health and Ecology program plan to address the immediate and projected information needs of the SPS project will be presented along with the status of SPS-supported research. A synopsis of the most significant recent research reports bearing on the potential health and ecological impact of the SPS will be discussed.

STUDY OF THE BIOLOGICAL AND ECOLOGICAL EFFECTS OF SPS MICROWAVE POWER
ON THE HONEY BEE

Norman E. Gary and Becky Brown Westerdahl
Department of Entomology - University of California, Davis

The proposed SPS system will increase ambient microwave energy levels in receiving antennae and in adjacent areas. Possible biological and environmental effects (whether adverse or beneficial) from microwave radiation within the surrounding rectennae need to be defined for a broad spectrum of animal and plant life. This information is needed in order to minimize possible hazards and to permit maximum possible use of microwave illuminated areas. Research needs are particularly critical for airborne biota such as invertebrates and birds which cannot be excluded from the rectennal area.

Honey bees are an ideal species to represent invertebrates that might encounter SPS frequency microwaves. Particular advantages of honey bees are their small size, relative simplicity of various body systems, ease and economy of propagation, expendability and short life cycle. In addition, honey bees have already been shown to be sensitive to various forms of electromagnetic energy. Studies using invertebrates can be conducted on larger numbers of individuals much more rapidly and with a higher degree of reproducibility. Chronic studies involving exposure of successive generations can be completed much more rapidly with invertebrates than with vertebrates. In addition, similarities between invertebrates and higher animals will facilitate the extrapolation of information for man's protection.

The following experiments have been completed in recent months: (1) the orientation, navigation and memory of foraging bees; (2) the survival and longevity of adult worker bees and (3) the survival of honey bee brood (eggs, larvae and pupae) following 30 minute exposures to 5 levels (3, 6, 9, 25 and 50 mw/cm^2) of 2.45 GHz CW radiation.

These studies were conducted in a newly developed microwave exposure facility designed by engineers from U. C. Davis and the Environmental Protection Agency at Research Triangle Park. A 2.45 GHz CW power supply (300 watts maximum power) transmits variable levels of microwave radiation to a horn antenna located atop a rectangular exposure chamber (internal dimensions 61X61X182 cm) lined with microwave absorber. Bees to be exposed are placed in styrofoam cages on the treatment platform 121 cm below the horn antenna. Control bees are placed in a sham chamber of identical construction connected by an air duct into the microwave chamber. Air from the microwave chamber is drawn through the duct into the sham chamber so that control bees are exposed to the same gaseous environment and held at the same temperature as the microwave treated bees. An additional group of control bees is held within the laboratory and never exposed within either chamber.

The first study completed utilized a bioassay that involved the behavioral elements of orientation, navigation and memory of honey bees. The ability of bees (which routinely leave the hive several times daily to forage for food up

to 8 km away) to successfully return to the apiary (colony group) following exposure was tested. Successful return to the colony requires normal metabolic functions that yield flight energy, and the various neuromuscular functions that coordinate visual input and flight. In this study, 6,000 foraging bees were captured upon their return to their hives, labeled with individually numbered plastic "ID" tags, exposed in the laboratory and then released near their hives (see Figure 1 for details of experimental design). Although slightly fewer bees (4% or less) returned successfully to their colonies in the microwave than in the sham exposures, the differences were so small as to be statistically insignificant.

The second study was designed to determine if 30 minute exposures to 5 microwave power densities would affect the survival and development of immature stages of honey bees. Three stages of honey bee brood (eggs, larvae and pupae) held within natural beeswax combs were utilized in this study, the experimental design of which is depicted in Figure 2. Analysis of the percentage of adult bees emerging following treatment did not yield any statistically significant differences between corresponding microwave and sham treatment groups although fewer microwave treated bees emerged following exposure of the egg stage.

The third study, the results of which are still being analyzed, was conducted to determine the effects of microwave exposure on the survival and longevity of adult worker bees in glass walled observation colonies following treatment. In this study, a total of 3,000 individually identified bees (550 from each of 5 colonies) were divided into 11 treatment groups (5 levels each of microwave and sham exposure and an additional in lab control group). A daily census of surviving bees was taken during 3 weeks following exposure.

Chronic exposures at variable power densities (including power levels lower than those used in the studies previously described) are currently underway and should yield additional data in a few months time. In these studies bees are allowed freedom of movement that will permit detection of responses such as attraction, repulsion, or normal behavior during exposure to microwaves.

Studies completed to date were restricted to tests for residual effects following short term microwave exposures. At this point there are no biologically significant differences that might indicate adverse or beneficial effects from exposures to radiation from Solar Power Satellites. However, there appears to be a very small difference between microwave treatments of adults and eggs and their respective shams that suggests the possibility of some type of electromagnetic effect acting on the more sensitive individuals within the population. If this is the case, longer exposures and dynamic behavioral assays (such as those depicted in Figures 3 and 4) should elucidate these effects.

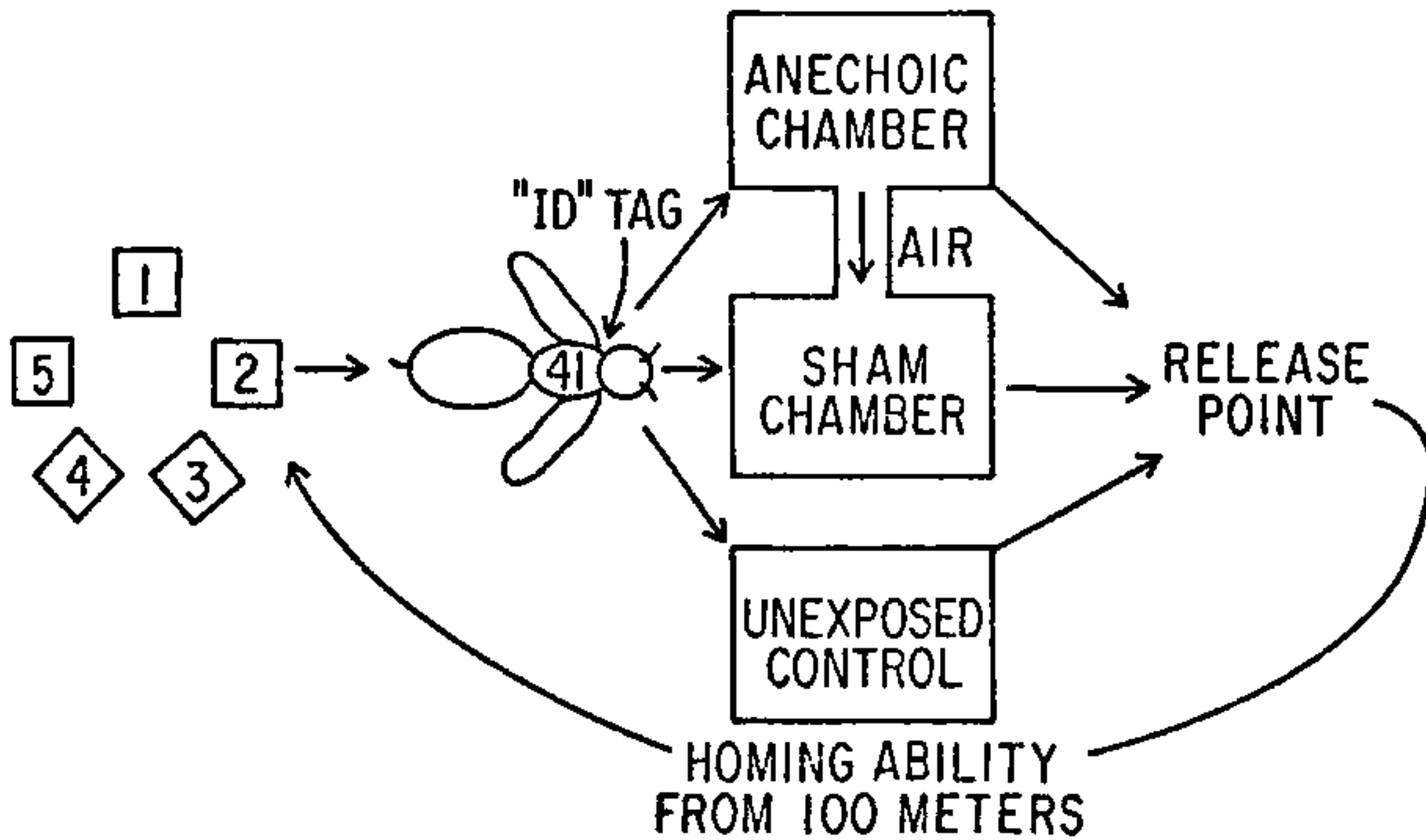

5 COLONIES X 10 BEES/TREATMENT X 12 TREATMENTS X 5 DAYS = 3,000 BEES
 ENTIRE STUDY REPEATED TWICE

FIGURE 1. EXPERIMENTAL DESIGN FOR ORIENTATION, NAVIGATION AND MEMORY STUDY

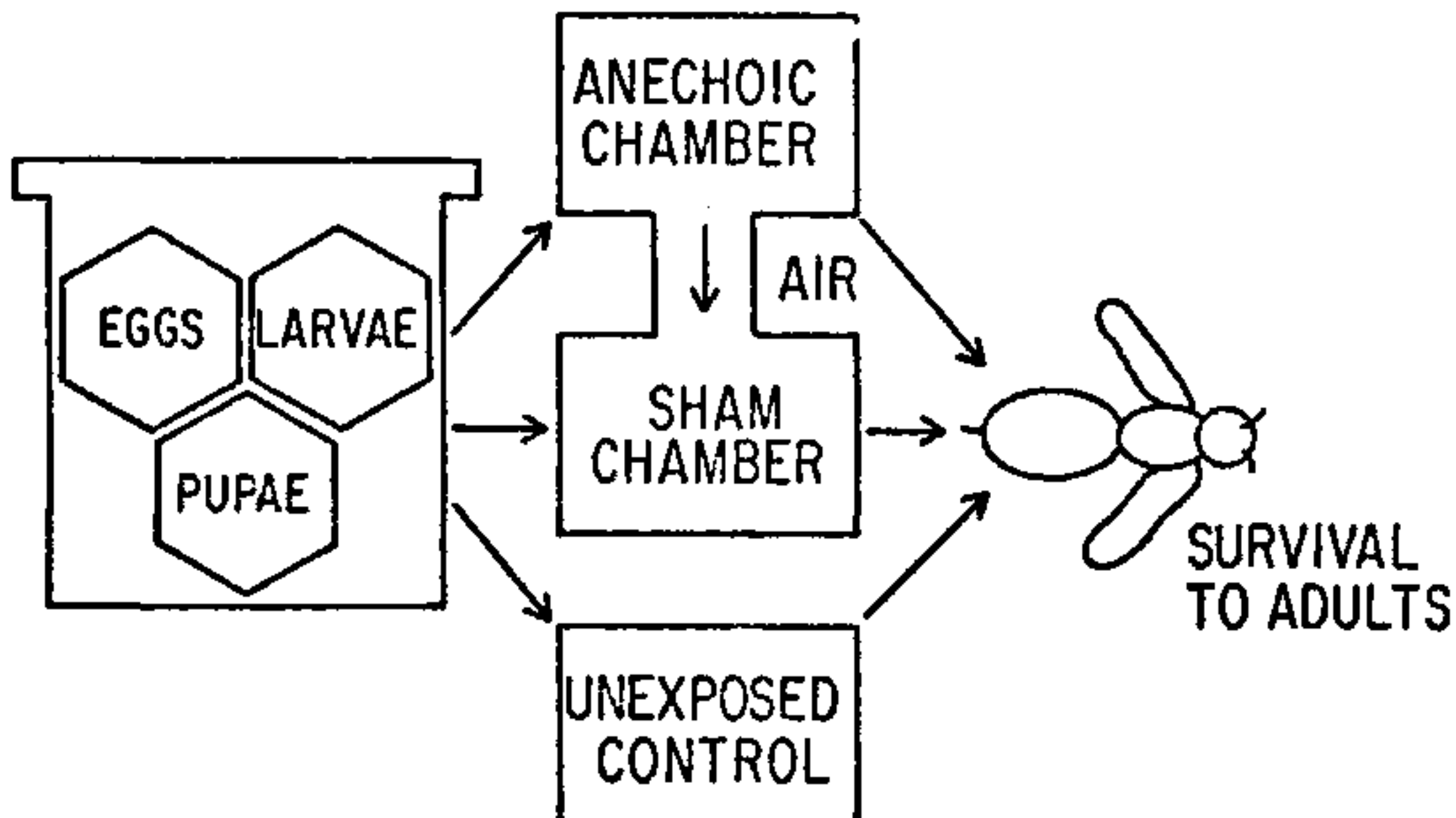

3 AGES IN COMB X 100 BEES/TREATMENT X 12 TREATMENTS X 6 DAYS = 21,600 BEES

FIGURE 2. EXPERIMENTAL DESIGN FOR BROOD BIOASSAY STUDY

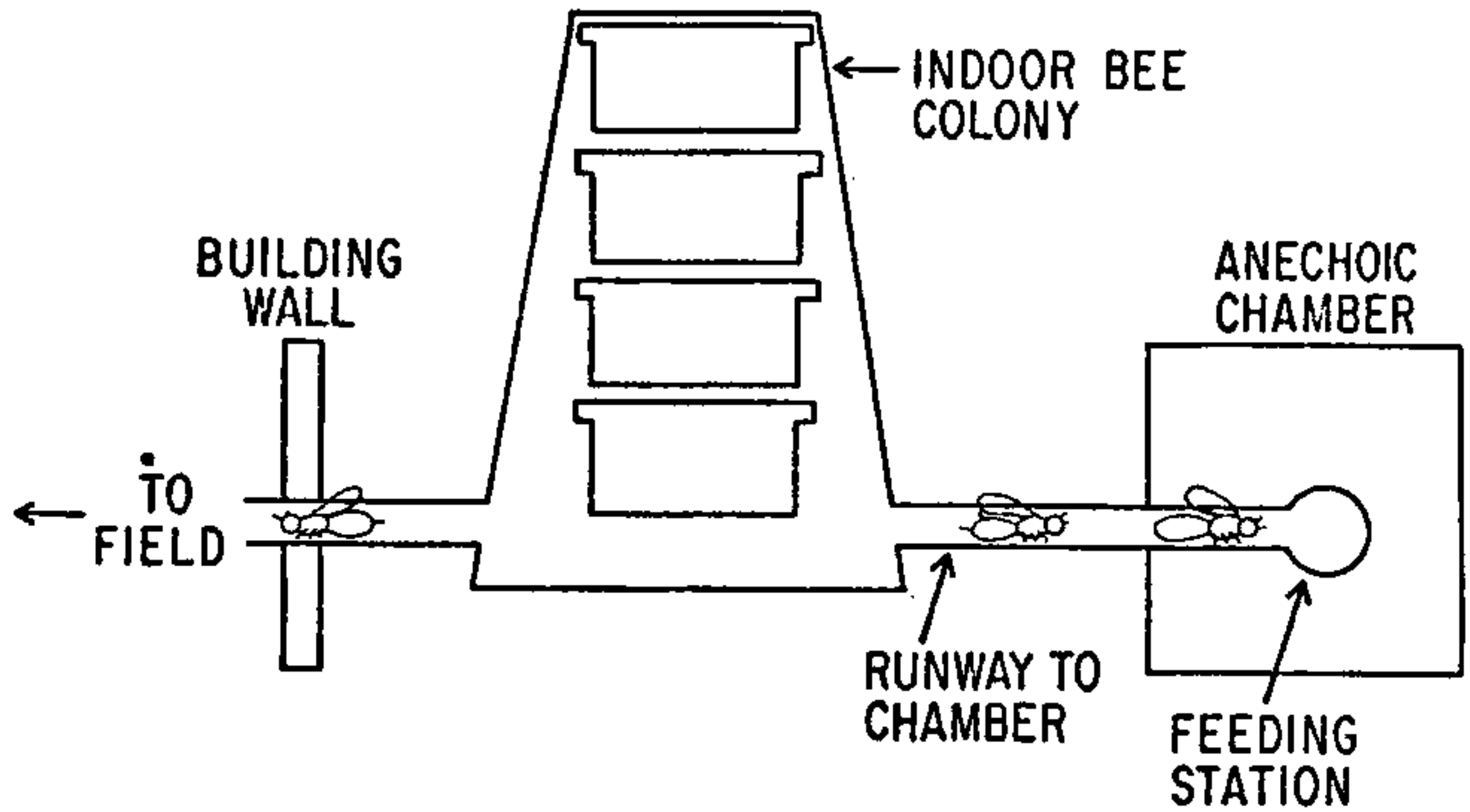

FIGURE 3. WALKING MAZE STUDY

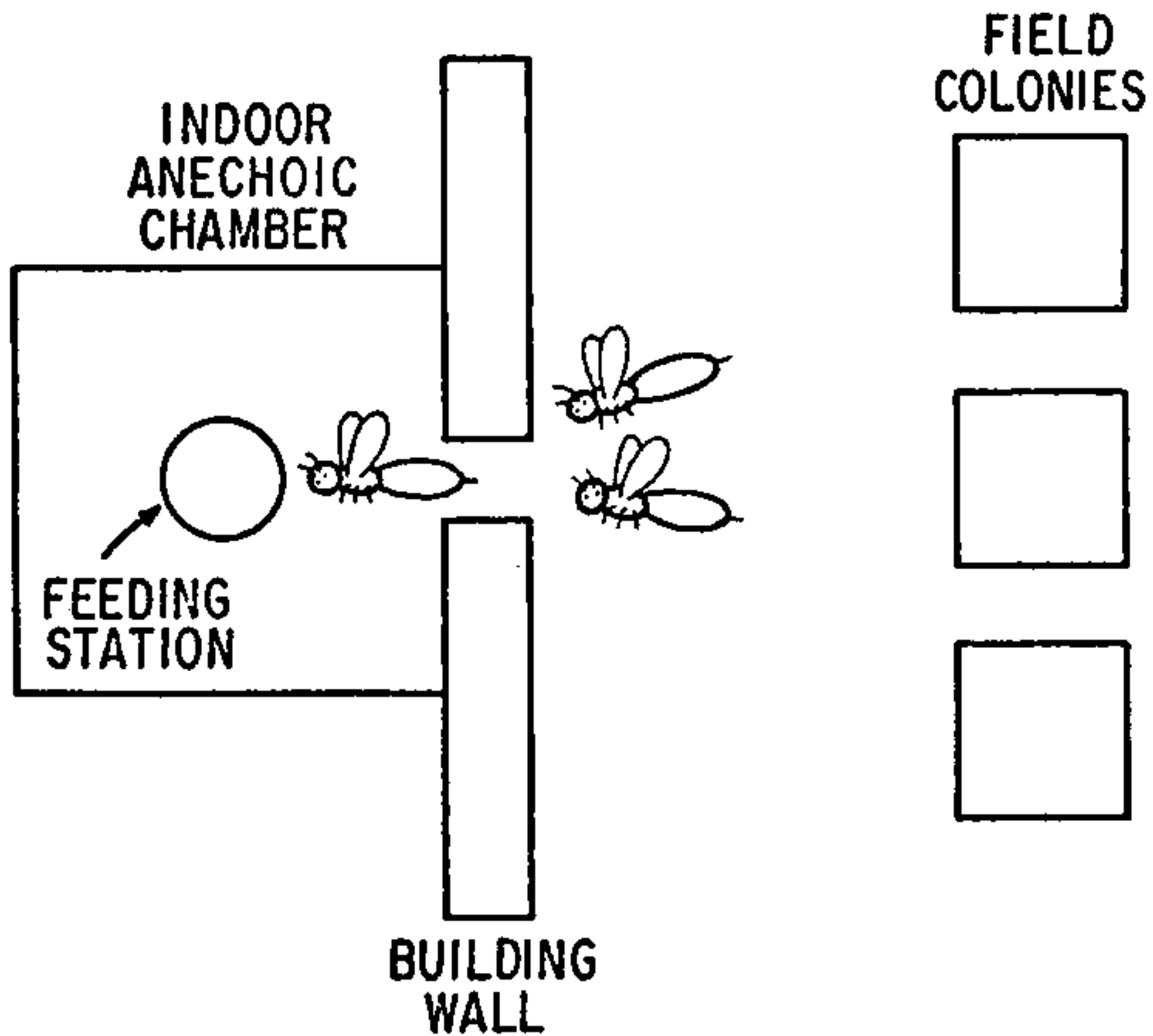

FIGURE 4. FLYING MAZE STUDY

SPS MICROWAVE EFFECTS ON AIRBORNE BIOTA STATUS REPORT
Battista, S.P., Cook, E. J., Kunz, T. H.¹, Hoyt, D.³, Wasserman, F. A.¹,
Byman, D.¹, Youngstrom, K.²
Arthur D. Little, Inc., Cambridge, Massachusetts 02140

A building has been completely renovated and provided with all the services required for maintaining and exposing birds to a wide range of microwave power densities (2.45 GHz). This dedicated microwave exposure facility was constructed at an isolated location to minimize the possibility of accidental exposure of the public to high voltage and microwave radiation.

Five microwave exposure chambers and two replicate control chambers are in the final stages of construction. Microwave energy from two generators with adjustable outputs will be used to establish a nominal power density of 25 mW/cm² in each of two chambers, and a third generator will be used to establish microwave power densities of 0.1, 1.0, and 10 mW/cm² in each of the other 3 chambers, respectively.

The design of exposure cages (for holding the birds during irradiation) that would not perturb the microwave field has been a demanding task because of limitations in the choice of structural materials that are both microwave transparent and compatible with biological systems. Prototypes, including Emlen orientation cages, have been fabricated.

The facility also contains a wind tunnel and two large flight cages. The wind tunnel is an open-jet type and is mounted on a tilt frame for adjusting the flow angle of the air stream. Construction is essentially completed and the unit is presently undergoing final adjustments to obtain uniform air flow. The two flight cages that have been designed and built are large enough to maintain bird fitness for flight in the wind tunnel.

The experimental designs for the various studies that are to be conducted at the microwave exposure facility are essentially complete. The goal is to provide data on the following: (1) the effects of microwave irradiation on time budget as measured by foraging behavior (House Sparrow); (2) molt (House finch); (3) nesting and reproductive behavior (Zebra finch), and egg physiology (Coturnix Quail); (4) social interactions (White-throated sparrow, Dark-eyed Junco); (5) attraction/aversion to the microwave beam (House sparrow); and (6) on thermoregulation during flight (Laughing gull, Budgerigar, Pigeon).

During construction of the facility, experiments have been conducted at the Manomet Bird Observatory to determine the effects of microwave irradiation on social interactions and survival. Under field conditions and low ambient temperatures, exposures of White-throated sparrows and Dark-eyed Juncos to 25 mW/cm² for 20 or 200 minutes had no noticeable effects on general behavior except for occasional gaping, reduced fluffing of feathers, and a possible greater tendency to rest. Juncos at 155 and 100 mW/cm² showed gaping behavior beginning 30 seconds after commencement of irradiation. At these levels, no birds exhibited delayed effects or changes in hierarchical position within the flocks (6 birds) or in type or level of social interaction. During lethality experiments, Dark-eyed Juncos were exposed to power densities of 130, 155 and 160 mW/cm². Besides gaping and panting at 130 mW/cm², the birds exhibited no adverse effects after 20-minute exposures. One of two birds exposed to 155 mW/cm² and two birds at

160 mW/cm² had considerable elevated cloacal temperatures, i.e. 42.3°C. Although additional exposures to these high power densities will be carried out, preliminary estimates of the median lethal dose for microwaves for resting birds in the field, during winter conditions (e.g. in Massachusetts) appears to be about 150 mW/cm². It is reasonable to expect that when birds are exposed in flight, or in still air, or at higher humidities and air temperatures they will be incapacitated and die at lower power densities than the above.

If gaping occurs in birds under normal heating conditions only after core temperatures exceed a fixed temperature above which heat stress occurs, e.g. >39°C, then the rapid onset of gaping under microwaves, e.g. 30 seconds, while birds core temperatures, presumably still low, may be a valuable and sensitive indicator for microwave effects.

The effect of microwave irradiation on orientation will be studied in Emlen cages at Manomet Bird Observatory during the fall of 1980-81 if the level of sky glow does not interfere with orientation. White-throated sparrows will be irradiated by 10 or 25 mW/cm² while orienting in Emlen cages.

1. Boston University, Boston, MA.

2. Manomet Bird Observatory, Plymouth, MA.

3. Harvard University, Cambridge, MA.

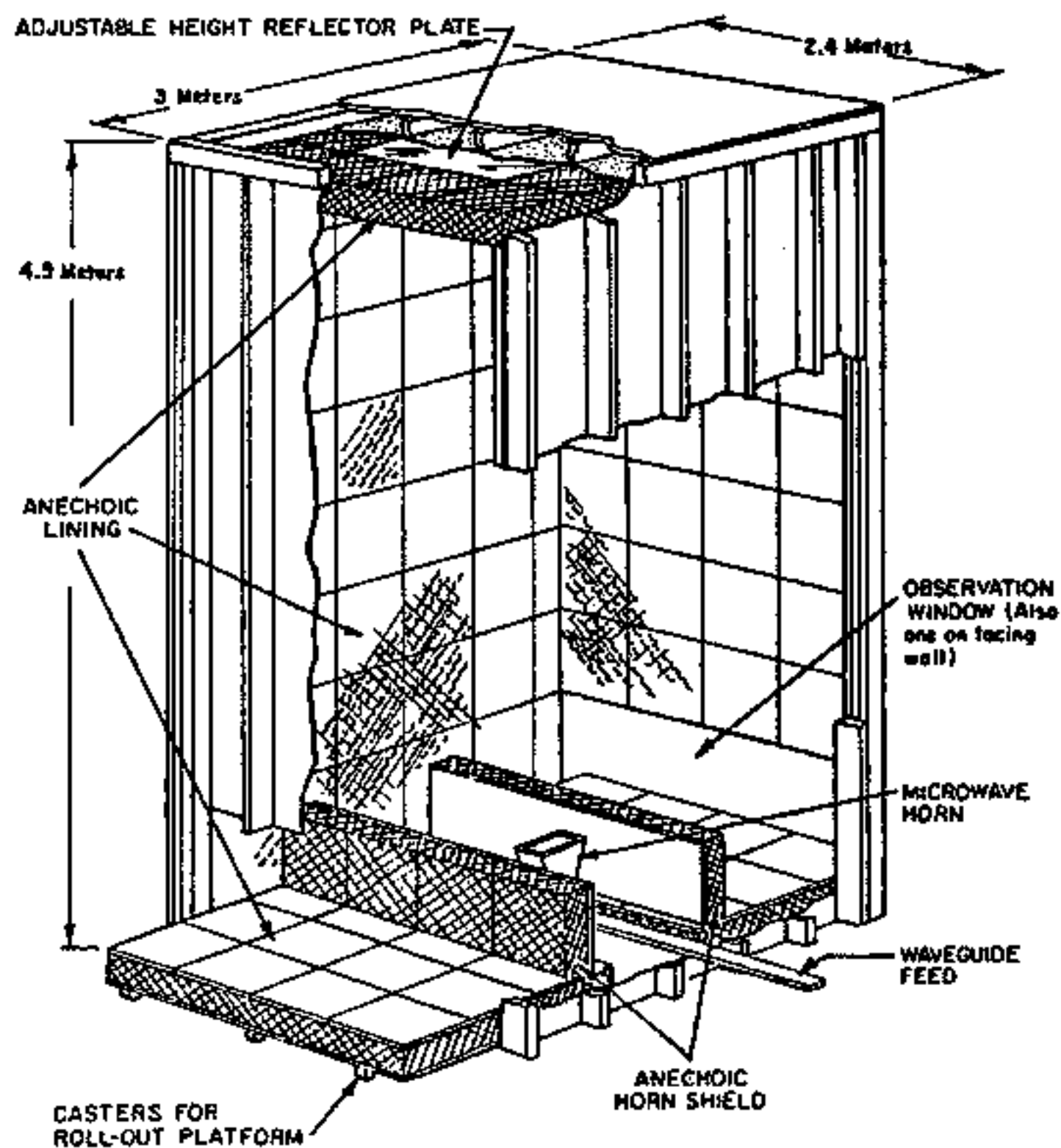
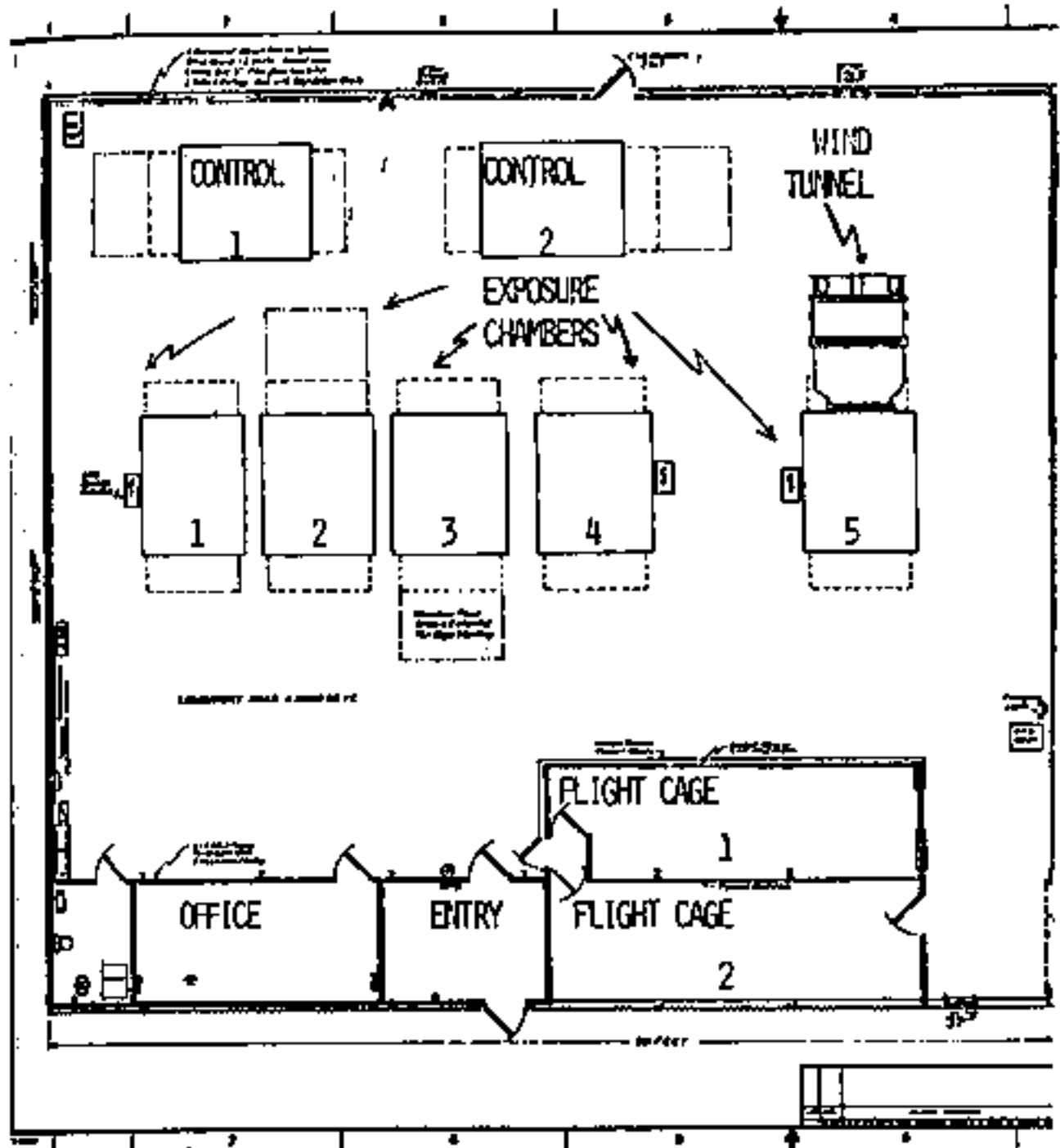

FIGURE 3. MICROWAVE IRRADIATION CHAMBER

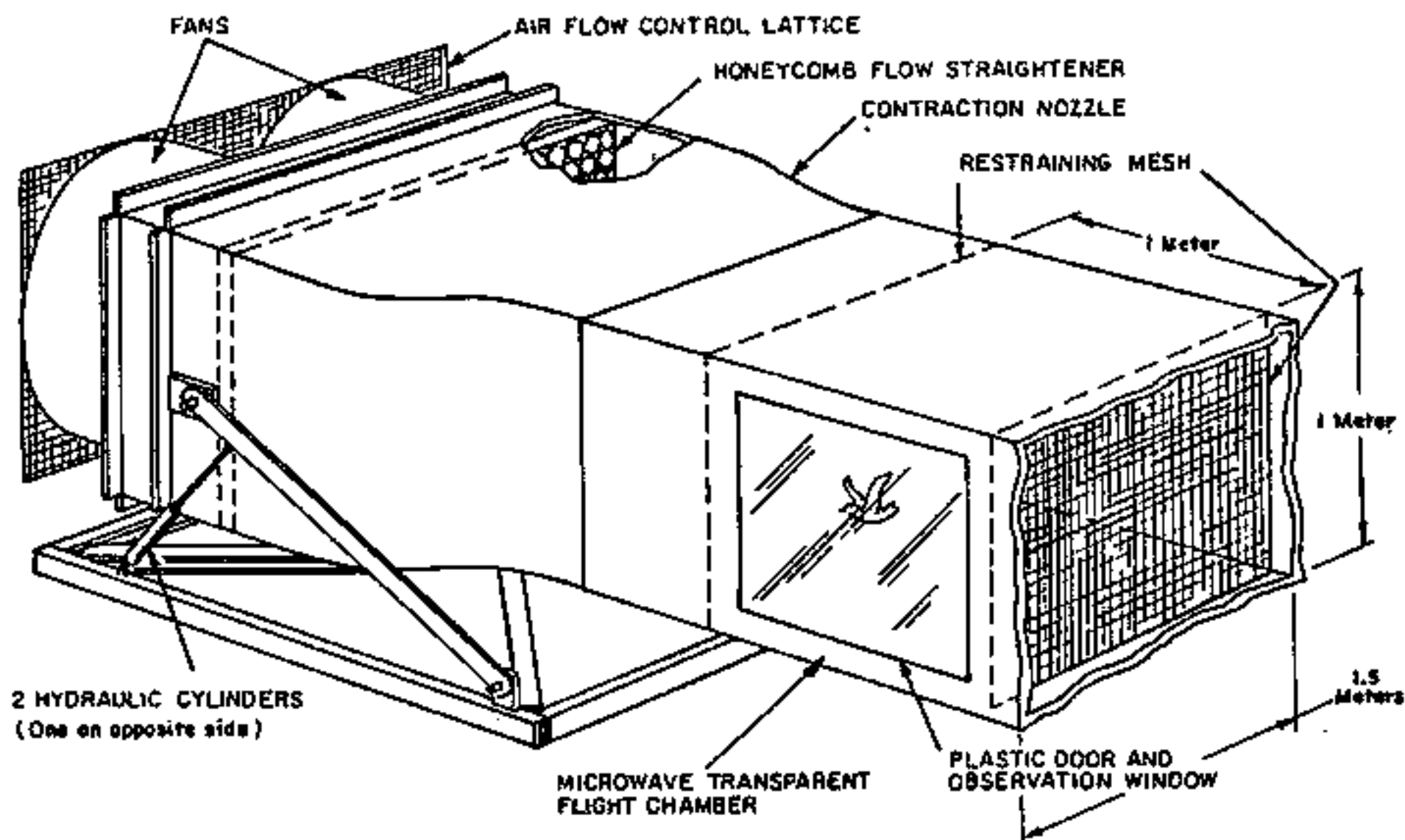

FIGURE 6. WIND TUNNEL AND FLIGHT CHAMBER

FIGURE 9

POWER DENSITY MAP IN MEDIAN PLANE OF CAGE

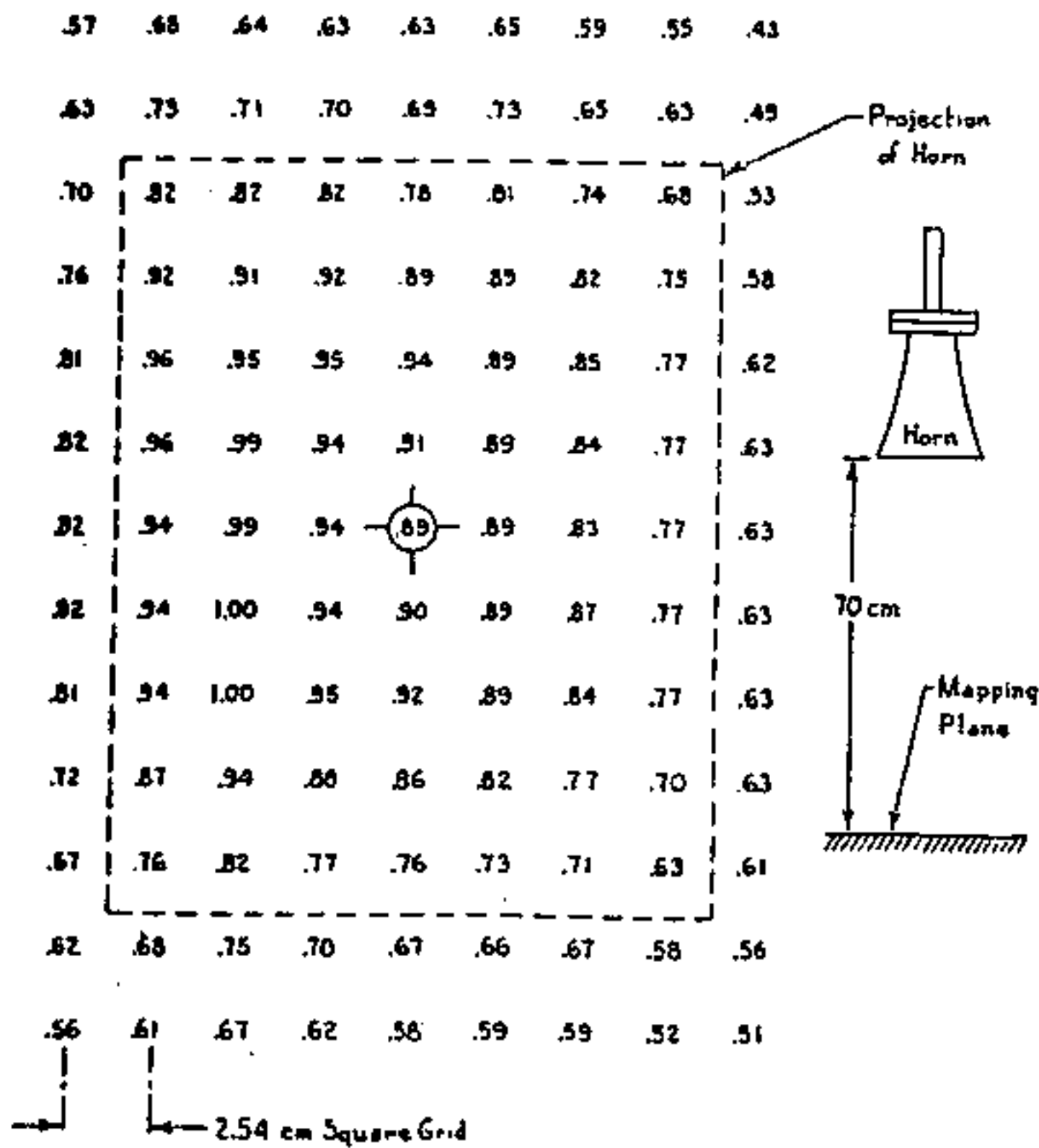

TABLE 5

EFFECTS OF MICROWAVE ON BIRD BEHAVIOR (HIERARCHY)

ANIMAL # (IDENT.)	CAGE # (CONTROL)	DURATION OF EXPOSURE (IN MIN.)	EXPOSURE COND. T°C	% CLOUD WIND COVER	RESPONSE TO EXPOSURE			
					HIERARCHY POSITION	AGGRESSION RATIO BEFORE	AFTER (ADJUST.)	
<u>0 MW/cm²</u>								
1 (Y-B)	6	20	-7°	5 NW 0	NONE	63/71	49/29	(4)
2 (-LG)	36	20	3°	15 NW 20	NONE	42/13	47/7	(6)
3 (PLB-)	36	20	3°	15 NW 20	NONE	32/28	29/25	(4)
<u>25 MW/cm²</u>								
4 (-YB)	2	20	-7°	10 NW 10	NONE	58/36	52/33.6	(4)
5 (W-W)	3A	20	-6°	5 NW 0	NONE	50/40	29/24	(4)
6 (Y-Y)	4	20	-3°	2 NW 5	NONE	40/43	42/49	(6)
7 (-LG) ^M	5	20	-7°	10 NW 10	NONE	60/46	19/50	(6)
8 (DB-DB) ^M	1	200	2°	12 N 5	NONE	22/36	75/50	(6)
9 (LB-) ^M	7	200	-7°	5 NW 0	NONE	16/32	110/72	(6)

TABLE 5 (CONTINUED)

EFFECTS OF MICROWAVE ON BIRD BEHAVIOR (HIERARCHY)

ANIMAL # (IDENT.)	CAGE # (CONTROL)	DURATION OF EXPOSURE (IN MIN.)	EXPOSURE COND. T°C	% CLOUD WIND COVER	RESPONSE TO EXPOSURE			
					HIERARCHY POSITION	AGGRESSION RATIO BEFORE	AFTER (ADJUST.)	
<u>100 MW/cm²</u>								
10 (B-)	2A	20	-3	15 N 30	NONE	49/11	44/5	(4)
11 (PLB-)	2A	20	-3	15 N 30	NONE	51/35	47/28	(4)
12 (DBY)	4A	20	4	15 NW 100	NONE	52/16	53/10	(4)
13 (R-LB)	4A	20	4	15 NW 100	NONE	44/44	53/54	(6)
14 (QB-)	5A	20	6	0 10	NONE	29/21	27/24	(4)

LETALITY OF BIRDS AT HIGH LEVELS OF MICROWAVES

NUMBER OF BIRDS	MICROWAVE POWER DENSITY (MW/CM ²)	SURVIVAL RATE	TIME TO DEATH	LOACAL TEMPERATURE BEFORE	AFTER
4	155	50%	7:15 ± 15 sec.		
2	160	0%	6:30 ± 20 sec.	36.9°C	42.3°C
2	130	100%	SURVIVED	37.9°C	38.6°C

^M WHITE-THROATED SPARROW;
ALL OTHERS DARK-EYED JUNCOS

⁴ RATIO OF # CHASES GIVEN TO NUMBER BECI
BEFORE AND AFTER IRRADIATION, AFTER ADJ
FOR DIFFERENCE IN OBSERVATION TIME.

A REVIEW OF EFFECTS OF SPS-RELATED MICROWAVES ON REPRODUCTION
AND TERATOLOGY

Ezra Berman

U.S. Environmental Protection Agency (MD-72) - Experimental Biology Division
Health Effects Research Laboratory - Research Triangle Park, N.C. 27711

During the next few minutes, I will be discussing the effects of microwaves on the reproductive system in mammals. In this talk, I will attempt to gather the diverse work in this general area, represented by approximately sixty articles, abstracts, contract reports, and other scientific publications describing experiments conducted at frequencies from 300 - 30,000 MHz. Because this audience is so diverse in its background and training, and because competent scientific reviews of this area have been made, I will not present a detailed review of the reproductive effects of microwaves. Instead, my purpose is to discuss some of the problems to be encountered in an evaluation of SPS-related microwaves as an influence on human health, and to present the problems so that this diverse audience can more easily appreciate the expected difficulties.

The areas of reproductive function that I will discuss are: teratology, where the fetus is treated while in the dam and the fetus is then examined for alterations; and male reproductive functions, such as sperm production.

The study of the reproductive effects of microwaves began about 20 years ago. The intervening years have resulted in approximately 100 reports of studies. Fortunately, a good portion of these studies have been conducted at the frequency relevant to this symposium, 2450 MHz. But, too frequently many of the reports contain little more than the author's interpretations of the data; what is needed are more reports containing clear descriptions of experimental conditions, materials, methods, and experimental results. During the last five years, the field of investigations into the reproductive effects of microwaves has matured with scientific discipline. The USSR literature has left us with a legacy of inadequately described experiments of reproductive effects. The scientists in that country, though, have lately begun to describe their experiments more adequately. Therefore, we can expect in the future a growing number of reports of scientific quality in the field of microwave reproductive toxicology.

I have noted that experiments in reproductive toxicology have been conducted at frequencies from 300 MHz to 30 GHz. It may appear that some of this range of frequencies does not have any relevance to human exposure at 2450 MHz. But there are ways in which these experimental data can be made more relevant to teratologic evaluations.

There are 2 reasonable concepts which describe the absorption of microwave energy into the body: the model of relative absorption rates, and the model of resonance. We can use these 2 models to attempt to extrapolate possible effects from one species to another, and from one frequency to another. Resonance can be simplified for this context to mean the most efficient absorption. The frequency-of-resonance is that frequency at which the most efficient absorption occurs in a specific body size. For instance, the mouse is resonant at 2450 MHz; the rat at 1000 MHz; and man has the most efficient absorption at approximately 100 MHz. (Figure 1.)

Along with the relationship of body size and resonance, is the relationship of body size with the distribution of energy. (Figure 2.) When the body size and the wavelength are approximate, energy deposition is non-uniform. At frequencies where the body size is smaller than the wavelength, the distribution is uniform. And, when the body is larger than the wavelength, the distribution of energy is surface directed. We can see, then, that there can be great differences in ab-

sorption rates and absorption patterns when one compares or scales across species and frequencies. In the interest of extrapolating animal teratologic studies to man, we can attempt to scale to a limited degree.

For example, let's look at the teratologic effects of 2450 MHz in the mouse and rat. The mouse fetus responds to daily exposure at 2450 MHz and 28 mW/cm², conditions very related to SPS, with a body weight decrease. The rat fetus appears unmoved under these conditions. If we factor into this exposure situation the scaling for relative absorption rates, we see that the rat had absorbed only about 1/5 that which the mouse had absorbed. One might suggest an experiment where the power density is increased 5 times to 150 mW/cm² as compensation for the lack of absorption in the rat, and so that the rat fetus might respond like the mouse fetus does. But, the rat dam does not survive such power densities. Death due to over-exposure at 2450 MHz begins to occur in the rat at only 40 mW/cm².

When the distribution of energy in mouse and rat is compared, the patterns of energy distribution may account for both the lack of rat fetal changes and death of the rat dam. The energy distribution is surface-directed in the rat. At 28 mW/cm², the fetus has little chance to receive a significant portion of this energy as it is buried deep in the dam's tissues. At higher power densities, the surface circulation of the dam, normally used for heat loss, brings into the body the energy which cannot be disposed of otherwise; death ensures before the fetus can be altered.

Now, the rat may not be a good model for understanding teratologic mechanisms at 2450 MHz, while the mouse is. But, scaling of energy distribution and relative absorption rates from rat to women may represent a reasonably good model. In both these species, energy distribution is surface-directed and there is little chance for the energy to reach the fetus directly. And the relative absorption rates at 2450 MHz can be expected to be low in women. Women in a 2450 MHz field may experience only 1/10 of the rat's or 1/50 of the mouse's absorption rates.

There are many other factors which have been ignored in the conclusion that the rat might be a model for pregnant women exposed to an SPS-type situation on the ground (Figure 3). One of these factors is the metabolic tolerance of man. Because of a much greater capacity to rid the body of excess heat by the use of mechanisms like sweating, man's tolerance to heat is 3-5 times greater than that of the rat. This means that surface directed distributions of energy, as is the case for 2450 MHz in both man and rat, have a much more important consequence in the rat. Non-uniform absorption which is mostly distributed on the body surface, as is the case with women in a 2450 MHz field, may not represent a hazard to the human fetus, even if power densities do reach 23 mW/cm².

Reproductive aspects for men in such situations is possibly a different case. The factors we have used for extrapolating animal fetal effects to human fetuses can also be brought into play in extrapolating testicular effects in animals to men. As the human fetus is protected by distance from surface-directed absorption, testes tissue is not so protected. The testes lie immediately below the skin surface, and a significant fraction of the energy can be expected to deposit directly in the tissue of the testes.

The testes tissue is unique in that its capacity to function is related to its temperature. Structural and physiologic mechanisms are normally used to help prevent testicular temperatures from reaching body temperatures, because it is at body temperature that sperm production is restrained or ceases. Unless actual

pathologic lesions are caused by increased testicular temperatures, this sterility or less of fertility is relieved when the testicles return to their normal operating temperatures below body temperature.

When we discussed teratology and the relative absorption in man and rat we were very concerned about size. The body size of man is about 150 times that of the rat. But the ratio of man's testicular size to the rat's or other laboratory animals' is much less. Consequently, we might expect more similar relative absorption rates and more similar energy distributions. The studies conducted to examine the response of the testes to microwave exposure should then be more susceptible to extrapolation from animals to man.

In one study of rats, a temporary sterility was induced in males after 4 weeks of exposure for 4 hours per day in a microwave field of 2450 MHz and 28 mW/cm². Testicular temperatures in this regimen reached 37.5°C in 90 minutes. In another study in dogs, calculations would have that animal's testes temperature reach 38 or more degrees at 20 mW/cm² at 2880 MHz for 1 hour.

Testicular temperatures like these could cause some decrease in fertility indices in men. Studies done in men exposed occupationally to unknown levels and frequencies of radar for unspecified durations imply that laboratory measured indices of fertility are decreased, but with no effect on functional fertility. And, maybe this picture is that which can be expected in men working in the rectennae site.

We have seen that attempts to relate microwave studies of teratology or testes effects in animals to humans can be made, but the models are tenuous. Teratology and male fertility are only 2 of the effects which have been noted in the literature of reproductive effects of microwaves. This (Figure 4) is a list of others that eventually will require evaluation and extrapolation to remove insecurity about SPS-related health effects.

Until the program for the study of the health effects of SPS-related exposure situations includes animal models which more closely resemble man than do rodents, we will remain with such insecurity.

FIGURE 1

Approximate Relative Absorption Rates (mW/g) for:

FREQUENCY (MHz)	MAN (70000g)	RAT (400g)	MOUSE (25g)
100	10	2	1
1000	3	40	20
2450	2	20	100

FIGURE 2

**Relationship of Body Size and Frequency
Energy Distribution Characteristics in:**

FREQUENCY (MHz)	MAN	RAT	MOUSE
100	Non-uniform throughout	Uniform throughout	Uniform throughout
1000	Surface directed	Non-uniform throughout	Uniform throughout
2450	Surface directed	Surface directed	Non-uniform throughout

FIGURE 3

REPRODUCTIVE EFFECTS

Other factors to be included in rat:woman model of teratology

	RAT	WOMEN
Metabolic range	3	10-15
Body size	Small	Large
Body shape	Prolate spheroid	Cylindrical
Abortion	Unusual	Common
Number in pregnancy	10	1
Length of gestation	3 weeks	36 weeks
Reproductive efficiency	High	Low
Genetics	Pure	Mixed

FIGURE 4
REPRODUCTIVE EFFECTS

Teratologic considerations in the fetus:

- death
- anomalies
- body weight
- brain size

Teratologic considerations, postnatal:

- stunting
- early death
- decreased survival to microwaves
- behavioral changes

Testes-related:

- infertility
- sterility
- prostatic function

Female function:

- estrual cycle shifts
- lengthened pregnancy

BIOLOGICAL EFFECTS OF CHRONIC PRE-AND POST-NATAL EXPOSURE OF
SQUIRREL MONKEYS TO SPS FREQUENCY MICROWAVES

Joel N. Kaplan

SRI International, Menlo Park, California

The purpose of this study was to determine whether low-level microwave irradiation, at or below the ANSI-recommended radiation protection guide for human exposure, over an extended time had any effect on the pre- and postnatal development of the squirrel monkey. To date, the only research on ontogenetic effects of microwaves has been with rodents and typically at relatively high power levels [Bereznitskaya and Rysina, 1973; Chernovetz et al., 1977; Michaelson et al., 1976; Rugh and McManaway, 1976]. Since the primary goal of such research is to estimate the danger of chronic low-level exposure to man, a nonhuman primate was selected as our animal model because of its similarities to man in pre- and postnatal development.

Microwave irradiation of the entire body of unrestrained squirrel monkeys was achieved by using cavity/cage modules designed and built in our laboratory [Heynick et al., 1977]. The modules consist of a dielectric cage housed within a metal chamber into which microwaves are conveyed and "stirred". Twelve cavity/cage exposure modules were used to expose pregnant monkeys in pairs during gestation and mothers and infants together as dyads after birth. For simultaneous irradiation of two monkeys (or four when two mother-infant dyads were exposed) in one exposure module, the cage was divided in half by an opaque divider.

All switches, controls, timers, and meters for providing and monitoring RF power to each module were mounted on a separate unit attached to the module. This unit also contained all the components necessary to generate, measure, and control the microwave power. Within the cavity, the mode stirrer action and movement of animals modulated the peak field intensity at any point in a complicated manner.

Prior to exposure of the animal subjects, cavity measurements were obtained by whole-body calorimetry on two identical rubber dolls [Anne, 1968] approximately the size of an adult squirrel monkey which were filled with saline and enclosed in specially constructed, coffin-like, 2-inch-thick Styrofoam insulating boxes, one in each half of the exposure cage. Plane-wave calorimetry measurements were also obtained on the same dolls in order to determine the whole-body power absorption per milliwatt per square centimeter of incident plane-wave radiation for extrapolation to the cavity-cage environment.

Subjects in our initial experiment were 41 pregnant squirrel monkeys (Saimiri sciureus) from SRI's breeding colony assigned to one of four dosage groups (0, 0.1, 1.0, or 10.0 mW/cm² equivalent) as pregnancies were diagnosed. As births occurred, animals were randomly assigned to groups that either terminated exposures (i.e., switched to 0 level) or continued exposures. In both cases, infants were treated together with their mothers until they were approximately 6 months old and then alone (after weaning) for an additional 6 months. Exposures occurred 3 hr/day, 5 days/week (Monday through Friday) throughout the study and were interrupted only when certain specific tests on the animals were conducted.

A variety of biological and behavioral measures were obtained on pregnant animals throughout gestation and on offspring during the first year of life.

These included weight changes, behavior during irradiation, perceptual-motor development of infants, maternal care, urinary catecholamines, plasma cortisol, PHA-stimulated response of peripheral blood lymphocytes, and different aspects of electroencephalographic activity. None of these measures differed in any systematic way among either dams or offspring of the various treatment groups.

In contrast to these results, a greater number of offspring died in the group exposed both pre- and postnatally to 10 mW/cm² than in any of the other groups. Table 1 shows the number of live births and deaths for each of the treatment groups as well as other pertinent information of the study. The gestation period for the squirrel monkey is approximately 22 weeks; therefore, exposures began primarily in the second trimester for all groups. As can be seen from the table, the percentage of live births was comparable among the different groups, but the percentage of infant deaths was not. No infants died in the control group, compared with 22, 17, and 56% in the 0.1, 1.0, and 10.0 mW/cm² groups, respectively. The annual mortality rate during the first year of life of animals born in our colony over the last 5 years has averaged 20 to 25%, so the results obtained on the 0.1 and 1.0 groups would not appear to be atypical. However, the number of deaths in the 10.0 group was substantially larger than the normal mortality rate and therefore would appear to be a direct result of the treatment. Moreover, four of the five infants that died in the 10.0 group were exposed both pre- and postnatally, suggesting a cumulative effect of the microwave exposures.

In all but one case, the deaths of infants were completely unexpected and occurred without prior warning. In each case, the dead infant was found in its home cage in the morning. The only infant that did not die suddenly was one in the 10 mW/cm² group exposed pre- and postnatally; it died when it was 177 days old, after having become gradually weaker over a 9-day period. Gross necropsies were performed on only four of the nine infants that died, and in no case was the cause of death obvious.

Because of the small number of subjects in the different treatment groups the significance of these mortality figures were questionable at the end of the study. Thus, in order to provide a more definitive answer as to the relative safety of pre- and postnatal exposure to 10 mW/cm² equivalent, a subsequent experiment was undertaken with a larger population of animals in which offspring viability at 10 mW/cm² was compared with that of sham exposure at 0 level. In this latter study pregnant monkeys were irradiated for 3 hours daily, 7 days/week beginning in the first trimester of pregnancy in the same chambers used in the first study. After parturition, dams were irradiated with their offspring for 6 months; then the offspring were irradiated alone until 9 months of age. Although this study has not yet been completed, the results obtained so far have not verified the original mortality findings. Moreover, as found before, both the general health and growth of exposed offspring did not differ from controls.

TABLE 1

Experimental Treatments and Viability of Mother and Infant Squirrel Monkeys
to 2450-MHz Microwaves During Gestation and After Birth in Initial Study

EXPOSURE PERIOD	MICROWAVE LEVEL (mW/cm ²)	NUMBER OF MOTHERS TREATED	ESTIMATED GESTATION AGE (WEEK) WHEN EXPOSURES STARTED*		NUMBER OF LIVE BIRTHS	NUMBER OF MOTHER DEATHS	NUMBER OF INFANT DEATHS	AGE OF INFANT DEATHS (DAYS)
			MEAN	RANGE				
CONTROL	0	8	10.9	7-14	8	0	0	
DURING GESTATION	0.1	5	10.3	7-15	4	0	2	32,83
	1.0	6	8.7	3-12	6	1**	0	
	10.0	4	8.5	7-10	4	2**	1	4
GESTATION AND FIRST YEAR OF LIFE	0.1	6	9.5	5-15	5	0	0	
	1.0	6	12.5	10-15	6	0	2	38,49
	10.0	6	9.4	5-13	5	0	4	58,78 143,177

* Based on 22-week gestation period.

** Deaths occurred shortly after parturition.

Table 2 shows birth and death figures to date for this latter study in which the youngest infants are presently 4 and 5 months of age for the control and microwave groups respectively. Thus, based on these last results, it would not appear that SPS frequency microwaves at power levels of 10 mW/cm² are lethal to primate offspring chronically exposed pre- and postnatally.

TABLE 2

Birth Results and Infant Mortality in Second Study
in which Microwave Exposures Occurred Pre and Postnatally
at 2450-MHz, 10 mW/cm² Equivalent

Group	Live Births	Stillbirths	Abortions	Infant Deaths
Microwave	21	4	6	6
Control	22	7	5	7

References

- Anne, A. (1963), Scattering and absorption of microwaves of dissipative dielectric objects: the biological significance of hazards to mankind, Doctoral dissertation, University of Philadelphia, PA, NTIS Document No. AD-408997.
- Bereznitskaya, A.N., and T. Z. Rysina (1973), Embryotropic effects of microwaves. In O Biologicheskoy Deystvii Elektromagnitnykh Poley Radiochastot, No. 4, edited by Z. V. Gordon, JPRS 63321, 230-236.
- Chernovetz, M. E., D. R. Justesen, and A. F. Oke (1977), A teratological study of the rat: microwave and infrared radiations compared, Radio Science, 12, 191-197.
- Heynick, L. N., P. Polson, and A. Karp (1977), A microwave exposure system for primates, Radio Science, 12, 103-110.
- Michaelson, S. M., R. Guillet, M. A. Catallo, J. Small, G. Inamine, and F. W. Heggeness (1976), Influence of 2450 MHz CW microwaves on rats exposed in utero, J. Microwave Power, 11, 165-166.
- Rugh, R., and M. McManaway (1976), Are mouse fetuses uniformly sensitive to microwave radiation?, Teratology, 13, 34A-35A.

Acknowledgement

This research was supported by Contracts 68-02-2248 and 68-02-3210 from the United States Environmental Protection Agency.

PRELIMINARY PLANNING FOR FUTURE SPS MICROWAVE HEALTH AND
ECOLOGY RESEARCH AND ASSESSMENT

C. William Hamilton

Battelle Columbus Laboratories, 505 King Ave., Columbus, Ohio 43201

The objective of the SPS microwave health and ecology assessment task is to identify, characterize and estimate the magnitude of potential bioeffects attributable to microwave radiation (MWR) at SPS reference system power densities and frequencies. This assessment includes effects on airborne biota, terrestrial and space workers, the general public and the ecology. The general toxicological categories that are being investigated include immunology and hematology, mutagenesis, carcinogenesis, reproduction, development and growth, behavior, physiologic and integrative processes, and drug interactions and special populations.

During the course of the SPS Concept Development and Evaluation Program (CDEP), investigative efforts have been directed toward identifying potential "program stoppers"; that is, potential MWR bioeffects that are severe, widespread in the population or ecology, and not subject to substantial mitigation. Such findings, if found to exist, would likely constitute an unacceptable risk in any decision to develop and deploy an SPS. Toward this end, two approaches have been adopted in the CDEP program. The first consists of "retrospective" studies -- corroboration or refutation of adverse MWR health and ecological effects reported in the scientific literature. Such reports, of course, are non-specific to SPS reference system conditions. The second consists of research in areas where few or no data currently exist and which pose questions initially judged to be of high priority in the concept evaluation of a microwave power transmission system. Research in this regard includes immunology, teratology, drugs and behavior, field complexity, and bird and bee experiments.

The results of the CDEP MWR assessment will be used in two ways: as evidence, to the extent it may exist, suggesting significant adverse effects ("program stoppers") and, second, as a basis for planning future, more comprehensive assessments of potential MWR effects. On a continuum, it is the objective of the SPSP0 to progressively reduce uncertainty/increase knowledge concerning human health and ecological effects associated with MWR at possible SPS power densities and frequencies. In this way the precision associated with quantitative risk assessment will increase over time, thus facilitating program decision requirements.

Direction of Future SPS MWR Research and Assessment

Any future decision on risk acceptance with respect to MWR health and ecology will be made in the public sector (the Congress). To support such decision-making, the SPSP0 must provide data and methodology to make precise quantitative predictions of pertinent human health and ecology metrics. More specifically, the assessment requirement consists of causal explanations of significant bioeffects (or their absence) in terms of biological system/MWR interactions, corroborated through data from cellular and animal experiments, and extrapolated to human health inferences. This, then, is the objective and planning guideline for future research and assessment in the SPS MWR task area.

To implement this objective, an approach consisting of three parallel lines of investigation is currently in a preliminary planning stage. The three investigative paths consist of acute, chronic and theory/mechanism research (Figure 1).

Both the acute and chronic studies will entail the generation of dose-response data associated with exposure to MWR spanning possible SPS design and operating conditions. Relevant topical categories of bioeffects measurement are shown in Figure 1. In addition, pertinent acute and chronic epidemiological data will also be incorporated in the assessment data base. A draft long range plan recommending a series of "prospective" acute and chronic investigations in the topical categories shown in Figure 1 has been prepared by the EPA and its Consultative Panel and, as such, constitutes the basis for subsequent program planning in this area.

Effort toward planning appropriate theory/mechanism research projects has been more recently initiated by the SPSP0, the EPA and the Consultative Panel. Initial topical categories of such investigations are also suggested in Figure 1. As a start along this path several small theoretical studies involving analytic biology and numerical solution are envisioned. Through scientific workshops review of these initial efforts, possible fruitful mechanistic investigations will be sought. In broad terms, it is the aim of the theory/mechanism approach to provide possible MWR bioeffect formulations usable in designing experiments (testable hypotheses) to provide empirical evidence required to support or refute theoretical findings. Also, it is intended that theoretical formulations will provide a necessary conceptual basis for guiding extrapolations to humans of experimental results obtained for cells, rodents and small primates.

The overall three-path approach and the general nature of bioeffect inferences expected to evolve over time with increasing precision (uncertainty reduction) are schematically portrayed in Figure 2. As a final note, it is understood that developments in MWR exposure technology and dosimetry will be integral parts of the research and assessment program plan.

FIGURE 1. PLAN FOR SPS MICROWAVE HEALTH AND ECOLOGY ASSESSMENT

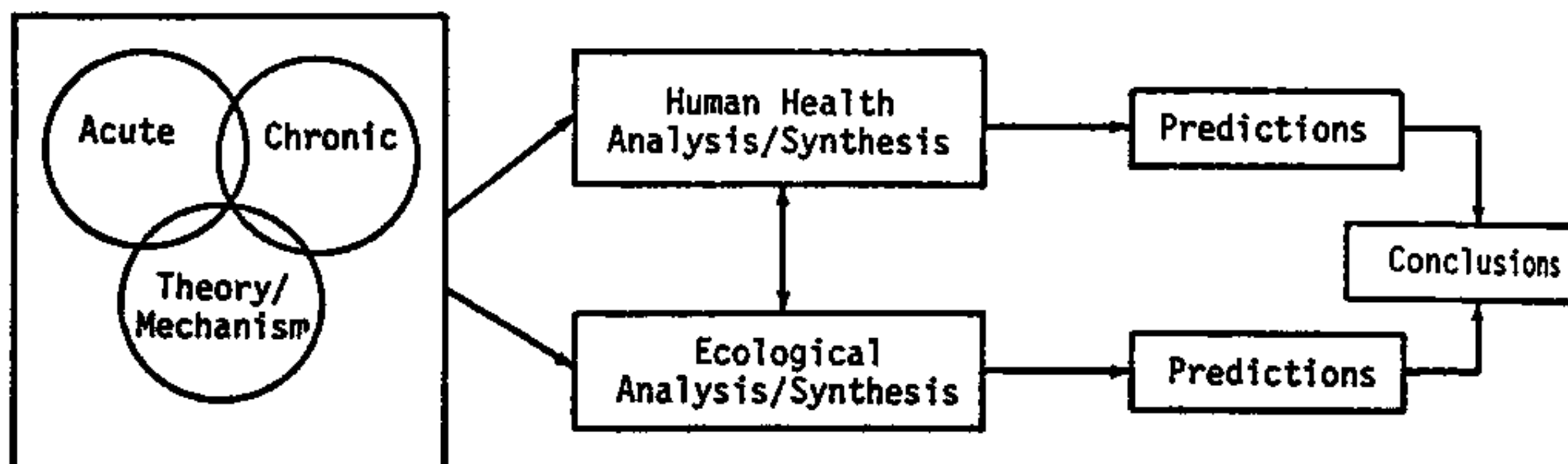

TOPICAL RESEARCH CATEGORIES FOR THE ACUTE, CRONIC, AND THEORY/MECHANISM COMPONENTS OF THE MICROWAVE HEALTH

I and II. Acute- and chronic-effects and dose response relationships

- (a) Reproduction/Teratology
- (b) Behavior & CNS
- (c) Mutagenesis
- (d) Endocrines
- (e) Cellular & Subcellular
- (f) Ecological
- (g) Immunology
- (h) Synergistic (Drug/MWR)
- (i) Epidemiology

III. Theory and Mechanisms

- (a) Quantal
 - (1) Molecular resonance
 - (2) Other resonances (molecular aggregate)
- (b) Classical
 - (1) E&H - field interactions
 - (a) Molecular (polarization, membranes, magnetite, hemoglobin)
 - (b) Electrophysiological
 - modulations
 - biorhythms
 - conduction velocity
 - (2) Distribution of Energy
 - (a) Local heating
 - (b) Whole body heating
 - (3) Induced currents

IV. Dosimetry and Densitometry are integral parts of each of the above programs.

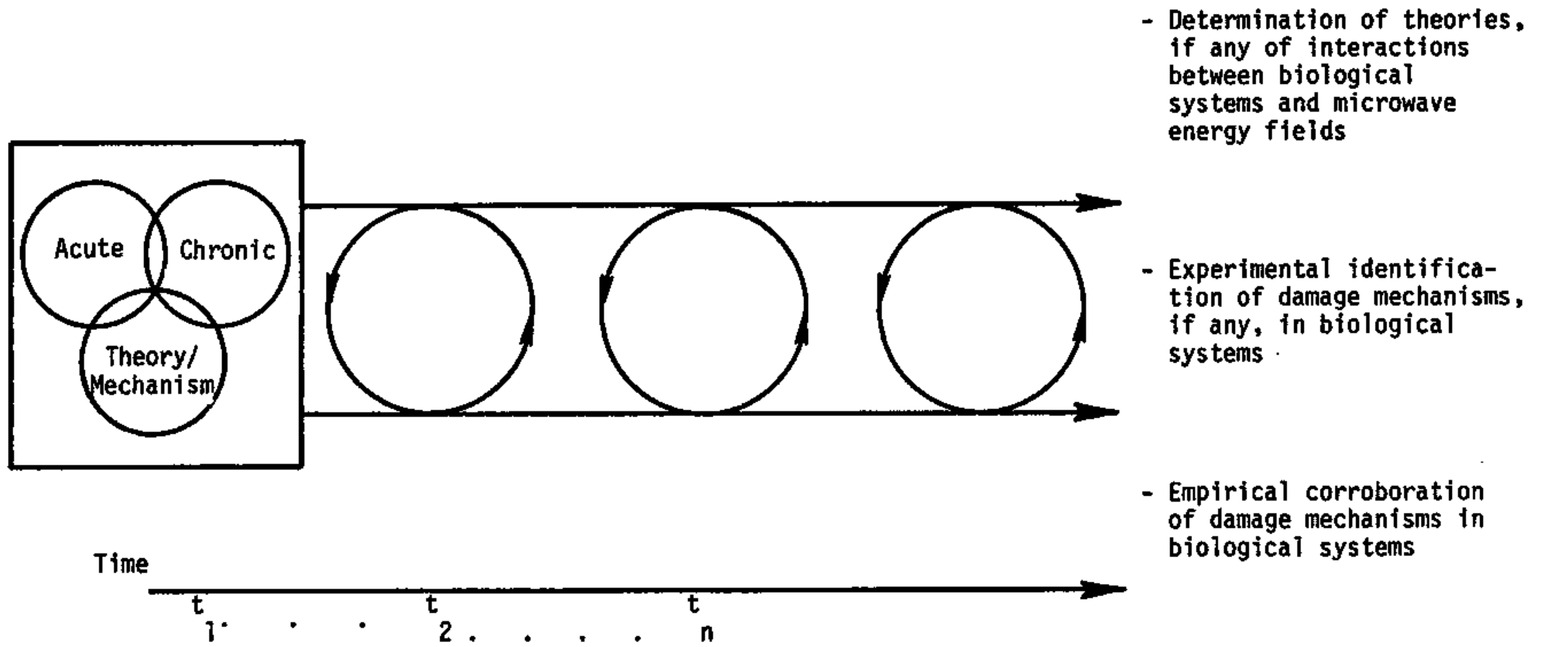

Inferences

- Biological property-microwave interaction hypotheses
- Bioeffect estimates of acute MWR exposure
- High confidence estimates of acute MWR bioeffects with associated mechanistic explanations
- Preliminary inferences of chronic MWR bioeffects with possible mechanistic explanations
- Qualitative inferences for human health metrics
- High confidence estimates of acute are chronic MWR bioeffects and associated mechanistic explanations
- Low confidence estimates for human health metrics (cross-species extrapolations)
- High confidence estimates of human health metrics
- Theoretical, mechanistic, and empirical explanations

SIMULATED D- AND E-REGION EFFECTS OF THE SPS POWER BEAM

Robert L. Showen

SRI International, Menlo Park, CA 94025

Since the beginnings of commercial broadcasting, the lower ionosphere has been inadvertently heated. The classical Luxembourg effect, in which the audio modulation from a powerful radio transmitter is weakly transferred to another radiowave passing overhead, is due to electron heating. In this paper the mechanism of the Luxembourg effect will be reviewed, the transmitters used to simulate the solar power satellite (SPS) microwave power beam are identified, and results of various experiments are discussed.

The cross modulations observed in the Luxembourg effect are possible because the electrons in the lower ionosphere have a very rapid thermal relaxation time, and suffer a collision frequency proportional to temperature. Since the ohmic absorption of radiowaves is proportional to collision frequency (when the collision frequency is less than the wave frequency), the passing wave will be more absorbed when the electrons are heated. Thus the oscillation of the electron temperature at an audio rate can produce cross-modulation of a wave passing through the heater volume. Cross-modulations measured on certain telecommunications frequencies will be discussed later in this paper.

The Platteville, Colorado, HF heating facility (5 to 10 MHz, 2MW into a 20 dB gain vertical antenna) and the old Arecibo, Puerto Rico HF facility (5 to 12 MHz, 100 KW into a 35 dB antenna) have been used to heat the D-, E- and F-regions of the ionosphere. A new Arecibo facility (3-12 MHz, 800 KW into a 23 dB antenna) is currently becoming operational. Additionally, incoherent backscatter transmitters at Arecibo at 40 and 430 MHz have heated the lower ionosphere. All of these transmitters are powerful enough to be equivalent in energy deposition in the D-region to the microwave power beam from the proposed SPS.

Results from the Arecibo 40 MHz heating experiment indicate that a simple theory of heating and cooling using the fractional energy loss parameter G can account for the observations. The 40 MHz transmitter with 1.5 MW power gives a power density of $.06 \text{ W/M}^2$ at 100 km, which is equivalent, after the frequency squared correction, to 225 W/M^2 at the SPS frequency of 2.4 GHz. This heating led to a measured electron temperature increase of 100 K - a 50% increase of the ambient 200 K temperature. The thermal relaxation time was also measured to be about 4 msec at 100 km. At lower altitudes the heating becomes greater and the relaxation time shorter due to the increased collision frequency, while, simultaneously, the number of electrons drops so that fewer and fewer electrons are heated more and more. This experiment has been repeated and extended using the 430 MHz transmitter and similar results were obtained.

In one set of measurements at the Platteville heater, cross-modulation was detected on four frequencies over a path 50 km to each side of the heated volume, from Ft. Collins to Bennett, CO. The four frequencies were 60 kHz (WWVB), 1410 kHz (KCOL), and 2.5 and 5.0 MHz (WWV). The cross modulation measured was typically .01 to 0.1%, which implies a significant change in electron temperature. Such magnitudes of cross-modulation could not be noticed by users of these broadcasts. For the 60 kHz wave the reflection altitude was only somewhat above 80 km, so this simulation was approximately SPS equivalent.

In another Platteville experiment, the heater was cycled on and off at a 15-minute rate to try to induce electron number density changes in the D-region. Attempts were made to detect phase changes that would be indicative of number density changes. Frequencies of 10 kHz (OMEGA) and 60 kHz (WWVB) were monitored, but no effect could be seen greater than the natural phase variability.

From all of the various experiments conducted so far, no effects have been observed that would indicate significant impact on telecommunications services from SPS power beam modification of the D- and E-regions.

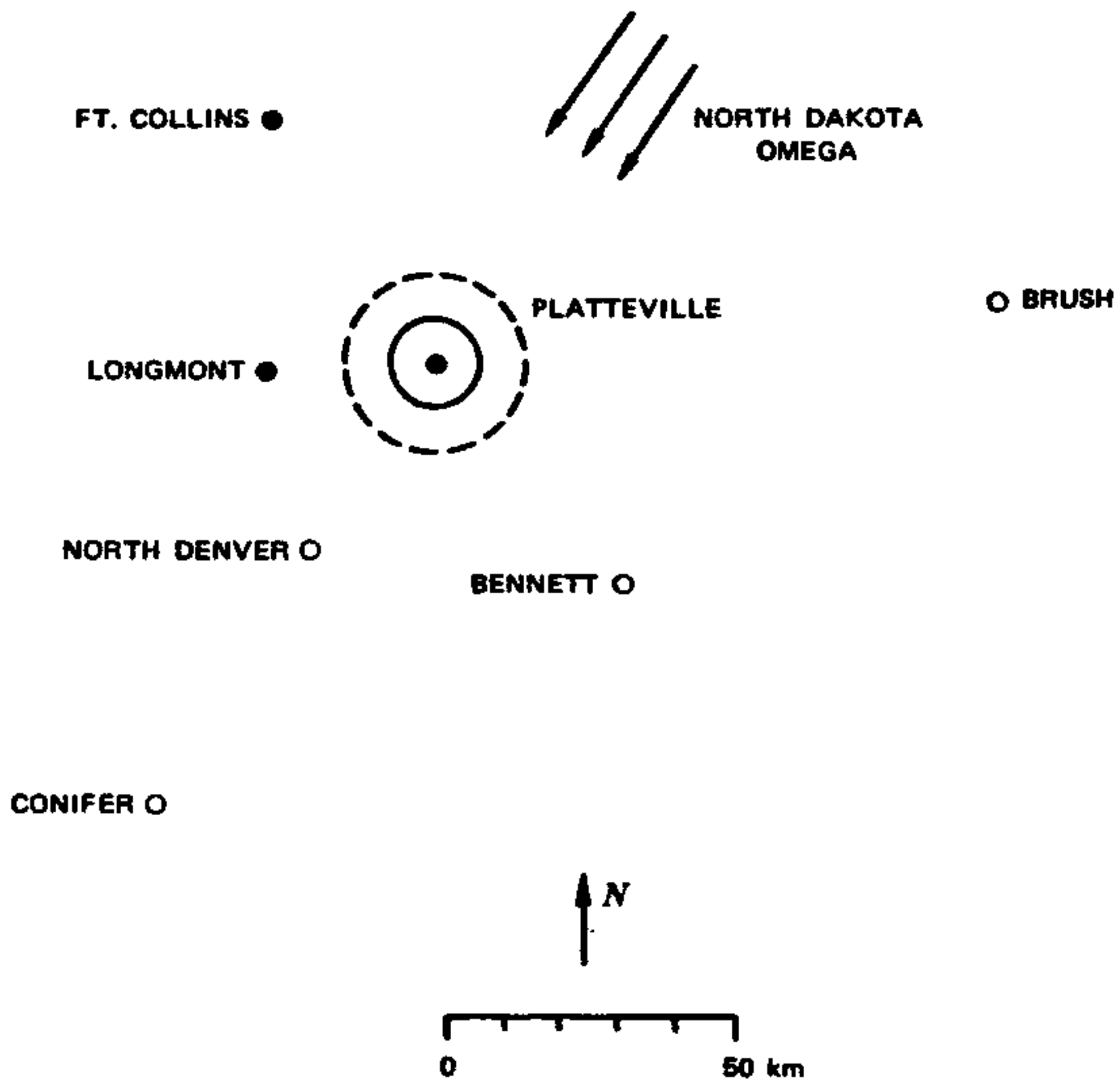

GEOMETRY OF EXPERIMENT. The HF heater at Platteville is shown by concentric circles indicating approximate beam widths at altitudes of 60 km (solid) and 120 km (dashed). Transmissions from Ft. Collins, North Dakota, and Longmont were received, after passing through the heated volume, at the receiving stations indicated by open circles. On the path from Ft. Collins to Bennett, cross modulation was detected on 4 frequencies from 60 kHz to 5 MHz.

MICROWAVE HEATING OF THE LOWER IONOSPHERE

G. Meltz and W. L. Nighan

United Technologies Research Center, East Hartford, Connecticut 06108

The SPS microwave power beam is sufficiently intense to cause large changes in the properties of the lower ionosphere by ohmic heating of the plasma. Although the fraction of power that is absorbed from the beam is very small, it is comparable to the solar heating rate of the neutral gas. Power is absorbed from the beam at a rate that is proportional to the product of the electron density n_e and the electron-neutral collision rate ν , and the ratio of the intensity S to the square of the microwave frequency f . The peak absorption occurs at an altitude where n_e is a maximum. During the day, this is between 75 to 105 km, depending on the time-of-day, season, and solar activity. The maximum ohmic loss rate Q_{\max} is approximately

$$Q_{\max} \approx 4 \times 10^{-7} (\nu n_e / 3.9 \times 10^9 \text{ s}^{-1} \text{ cm}^{-3}) \times (S / 23 \text{ mW cm}^{-2}) (f / 2450 \text{ MHz})^{-2} \text{ ergs/s - cm}^{-3}$$

using representative values for ν and n_e at 100 km. For comparison, the neutral heating rate is about $9.8 \times 10^{-7} \text{ ergs/s-cm}^{-3}$.¹ Since the microwave absorption is almost one-half of the solar heating, major changes can be expected in the properties of the D and E-layers of the ionosphere.

This paper addresses the development of a predictive model of the underdense interaction of an electromagnetic beam and the lower ionosphere. The interaction is considered to be underdense if the electromagnetic frequency exceeds the maximum plasma frequency throughout the ionospheric region of interest. A self-consistent fluid theory formulation of underdense heating, incorporating the latest information on electron cooling and electron-temperature-dependent reaction rates, has been used to estimate the expected changes in the lower ionosphere due to the SPS beam. A computer code has been developed to integrate the coupled equations for power density, electron temperature, and electron density as a function of altitude and time for both time-varying and steady heating fluxes. The principal electron cooling mechanisms are: (1) rotational excitation of N_2 and O_2 ; (2) vibrational excitation of N_2 and O_2 , and (3) excitation of 3P fine structure ground state levels of O. At the base of the D-region, namely at altitudes of 50-75 km, the density will decrease² due to an increase in the electron-temperature-dependent attachment rate to molecular oxygen. Above 85 km, the density will increase as a result of sustained heating due to a reduction in the recombination rate of O_2^+ and NO^+ .

The absorption coefficient and the corresponding ohmic loss are both inversely proportional to the square of an effective frequency f_e defined by

$$f_e = f [(1 \pm f_B / f \cos \theta)^2 + (\nu / 2\pi f)^2]^{1/2} \quad (1)$$

in terms of the gyrofrequency f_B , θ the angle between the propagation direction and the magnetic field, and ν an effective Appleton-Hartree collision frequency. It can be seen from (1) that unless $(f_B / f) \cdot \cos \theta \ll 1$ and $(\nu / 2\pi f) \ll 1$, ohmic loss and absorption will not scale simply as $1/f^2$. In general, the scaling from SPS to HF frequencies is quite complicated and nonlinear since an increase in temperature changes ν and thus f_e . The scaling is further complicated by the fact that the absorption coefficient is directly proportional to

n_e and thus depends on the ambient D and E layer electron density distributions.

The fluid theory results can be used to predict the effects of the SPS beam on the ionosphere and to judge to what extent the Platteville and Arecibo experiments simulate SPS conditions. The predicted changes in electron temperature and density for the SPS peak reference flux of 23mW/cm^2 are shown in Fig. 1 and compared with the estimated changes for the Platteville facility operating at 5 MHz X-mode with an effective radiated power of 102MW. It can be seen that Platteville is capable of simulating or exceeding the effects of the SPS beam over a 30 km altitude range, centered near 70 km. A detailed examination of the frequency scaling implied in Eq. (1), the absorption, and the reduction in flux due to spherical spreading shows why Platteville cannot simulate the effects of SPS heating over a larger altitude range. The effective frequency increases below 65 km due to electron-neutral collisions thus reducing the flux below SPS equivalent levels and the combination of nonlinear absorption and spreading loss limit the flux above 95 km. Nevertheless, Platteville will simulate SPS conditions throughout a major portion of the D-layer. In this portion of the lower ionosphere, the electron density will be decreased, rather substantially, after several seconds of heating due to an increase in the electron-temperature-dependent three-body molecular oxygen attachment rate.

The electron temperature generally reaches steady-state in less than one second but the density increases build up on a much longer time scale. The changes shown in Fig. 1b are after 10 minutes of heating. It is unlikely that sustained heating will take place on a longer time scale since the neutral winds convect the plasma across the beam at speeds of 10-30m/s.

The fluid theory estimates of the expected electron temperature increase assume that the energy distribution is Maxwellian. This is questionable since the degree of ionization in the D and E regions is too low for electron-electron collisions to thermalize the population. Following the approach of Engelhart and Phelps³, we have also developed a kinetic theory estimate by numerically solving the Boltzmann equation appropriate to ac heating of slightly ionized air. The integro-differential Boltzmann equation is solved parametrically in E/N and ω/N , where N is the total neutral density, $\omega/2\pi$ is the heating wave frequency and E is the rms electric field. If ω is much greater than the electron collision and gyro frequencies, then the energy gain per electron and the form of the distribution function depend on the effective electric field E/ω and the neutral composition but not the total density

The results of the kinetic theory computations are shown in Figs. 2a and 2b. For a flux of 23mW/cm^2 , the temperature increase is between a factor of two to three times ambient. The relative importance of the various electron cooling mechanisms is shown in Fig. 2b. At 115 km, the standard concentration of atomic oxygen is about 1.5 times that of molecular oxygen and as a result, a significant fraction of the energy is dissipated in $O(^3P)$ fine structure excitation.

The agreement between fluid and kinetic theory is quite good for a microwave flux of 23mW/cm^2 . With a power flux of 46mW/cm^2 , fluid theory predictions significantly overestimate the electron temperature increase by as much as 120°K .

A comparison of the fluid theory predictions and the Arecibo 430 MHz incoherent scatter radar experiments (Fig. 3) validate the E-layer electron temperature predictions. The difference between theory and experiment at 95 km (and below, not shown) is thought to be due to the interpretation of the incoherent backscatter measurements of electron temperature (cf. presentation by L. M. Duncan,⁴ and F. T. Djuth⁵ in these proceedings).

The following conclusions can be drawn from the theoretical results: (1) kinetic and fluid theory estimates for SPS flux levels agree and predict a factor of 2-3 increase in electron temperature; (2) the E-layer predictions are validated by the 430 MHz Arecibo radar heating experiments and recent HF Arecibo measurements also validate the D-layer results; (3) Platteville, operating at 5 MHz X-mode simulates or exceeds SPS effects over most of the D-layer; (4) electron density decreases of up to 50 percent can be expected below 80 km and increases of up to 20% can be expected in the E-layer.

REFERENCES

1. Perkins, F. W. and R. G. Roble: J. Geophys. Res. 93: 1611 (1978).
2. Tomko, A., et al.: J. Atm. Terr. Phys., in press (1980).
3. Engelhardt, A. G., and A. V. Phelps: Phys. Rev. 131: 2115 (1963).
4. Duncan, L. M. and W. E. Gordon: Ionosphere/Microwave Beam Interaction: Arecibo Experimental Results, these proceedings.
5. Djuth, F. T., et al.: SPS Heating in the Lower Ionosphere - An Experimental View, these proceedings.

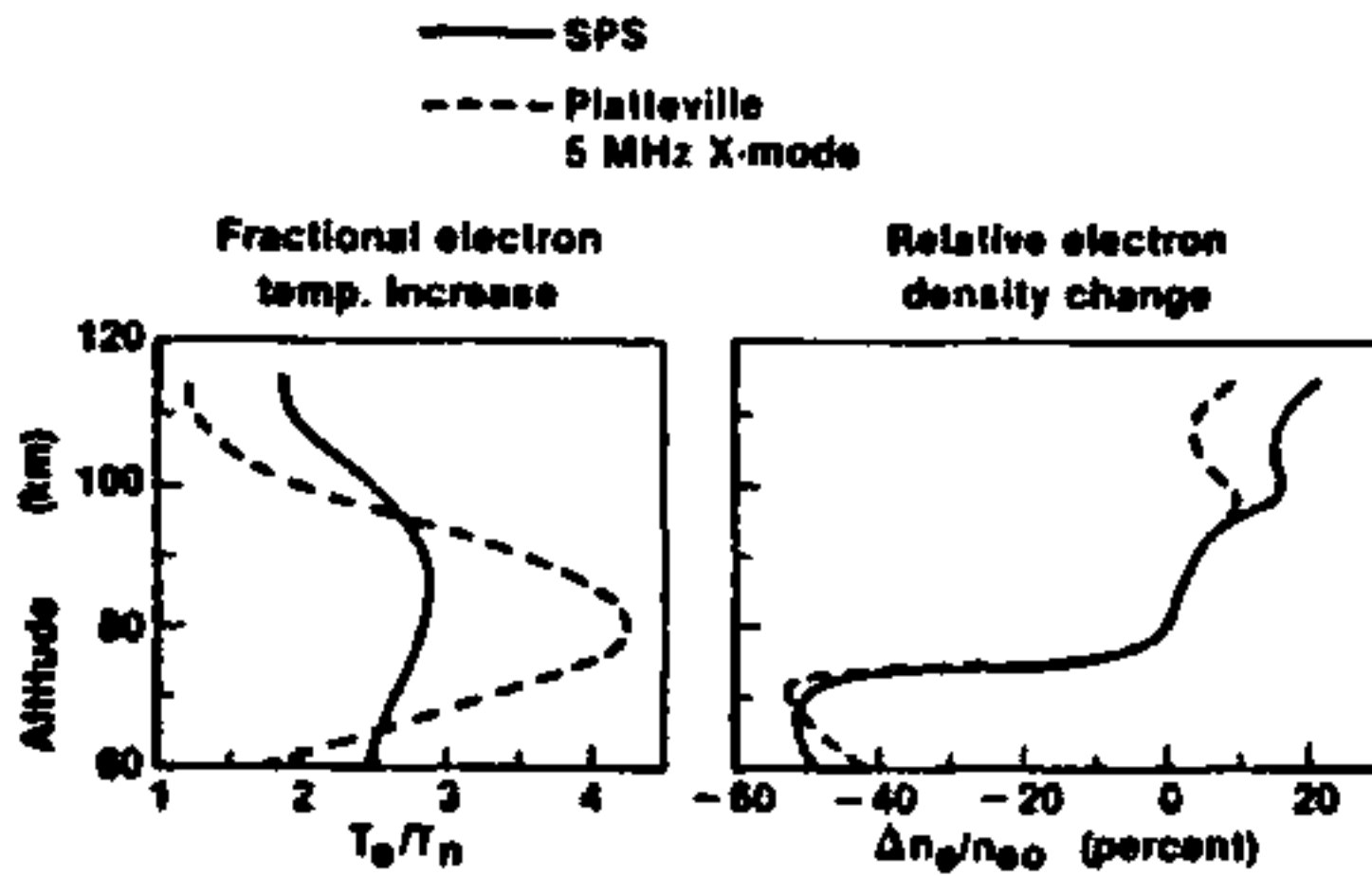

Fig. 1a

Daytime D&E Layer Modification

Fig. 1b

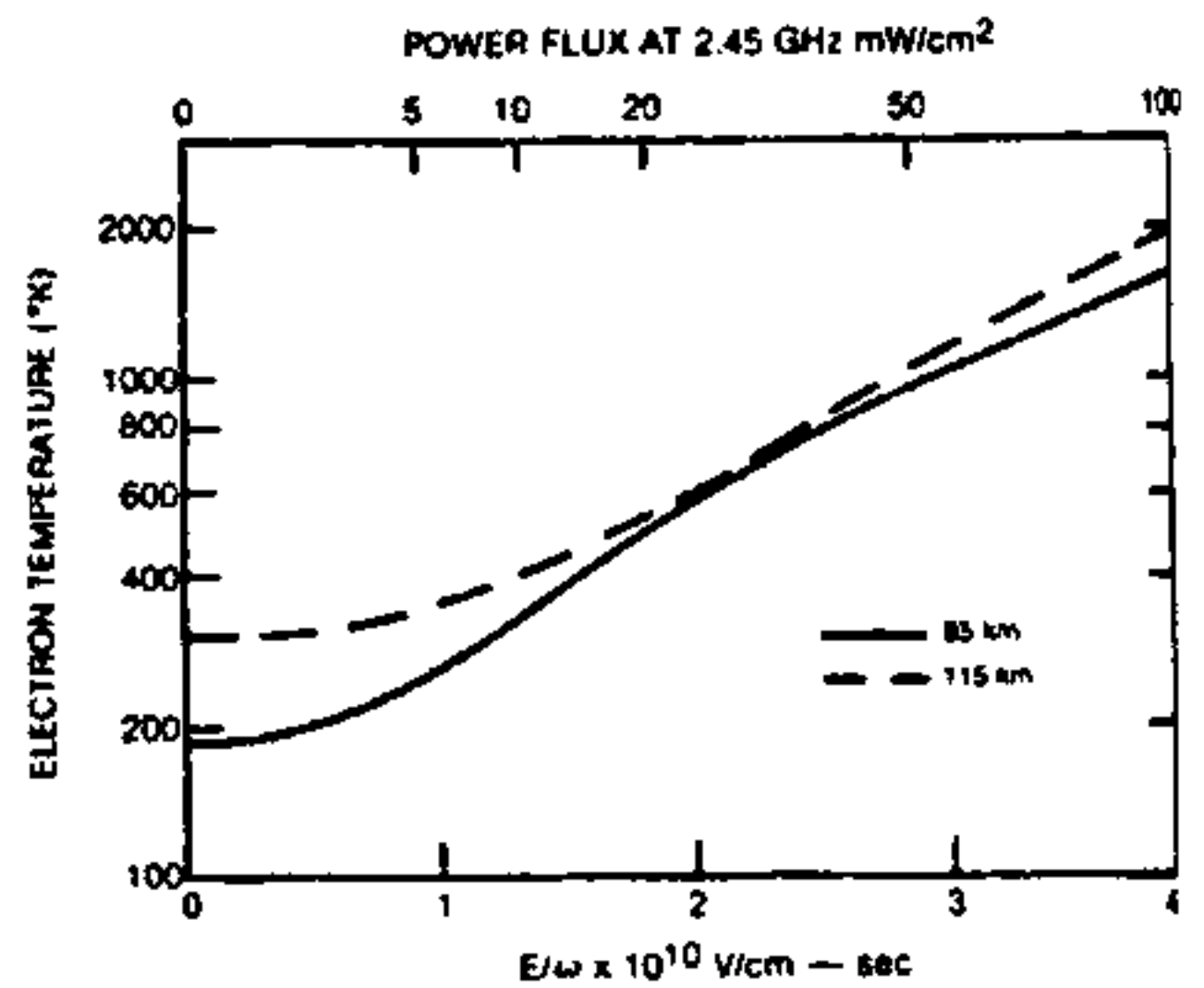

Fig. 2a Electron Temperature as a Function of Effective Field and Power Flux

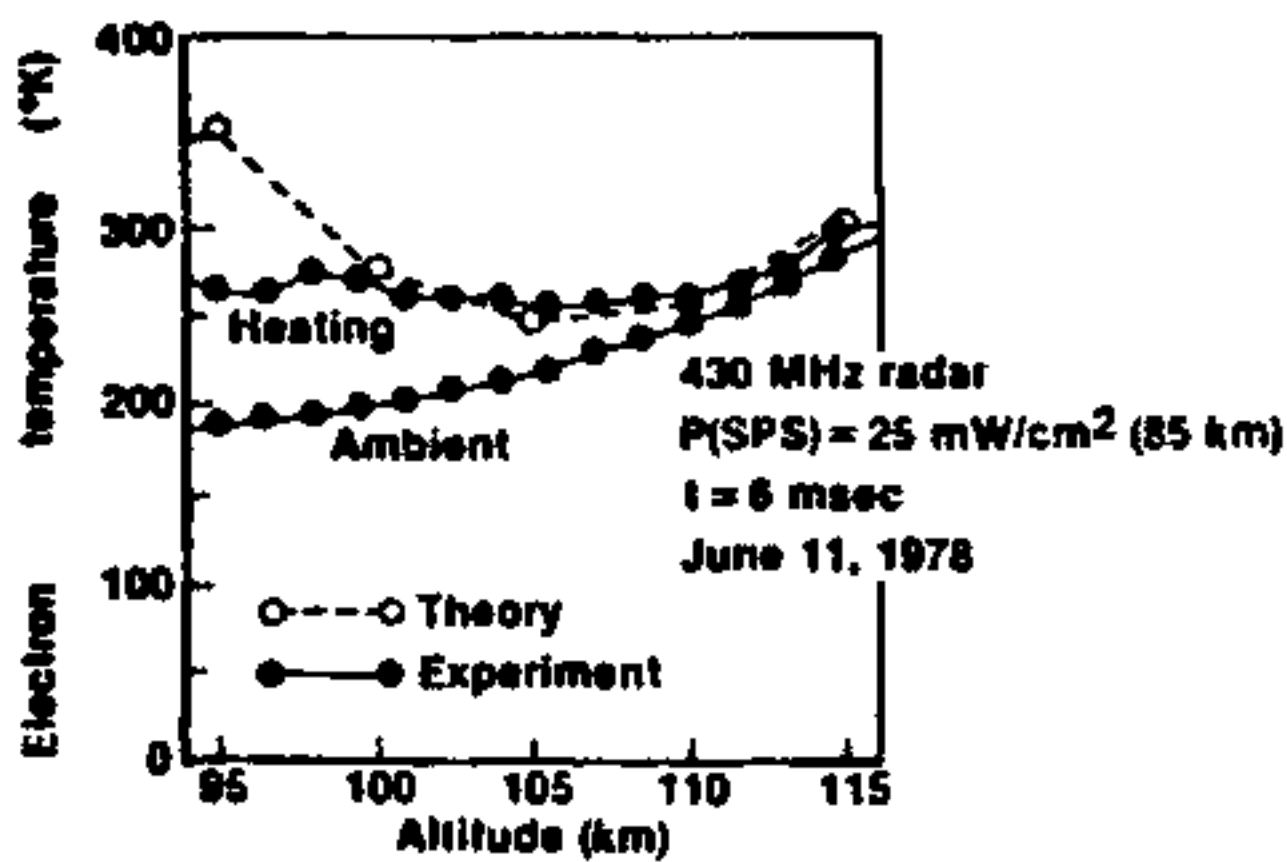

Fig. 3 Arecibo Electron Heating Observations

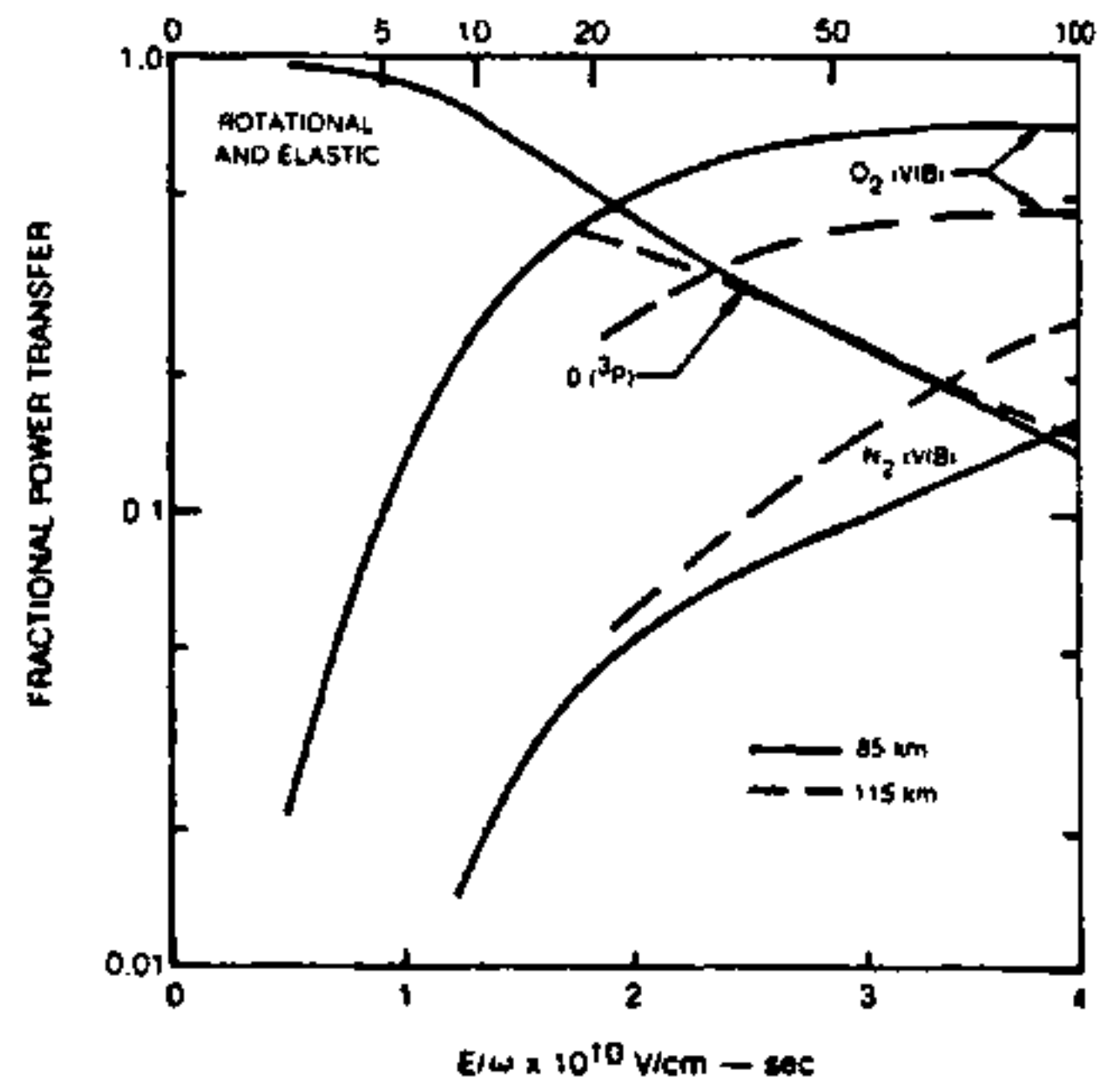

Fig. 2b Electron Cooling Mechanisms

IONOSPHERE/MICROWAVE BEAM INTERACTIONS: ARECIBO EXPERIMENTAL RESULTS
Lewis M. Duncan, Los Alamos National Scientific Laboratory, Los Alamos, NM
William E. Gordon, Rice University, Houston, TX

The microwave power-transmission beam of the Satellite Power System (SPS) is predicted to interact with the earth's ionosphere, potentially affecting numerous telecommunications systems. The physics of these interactions and the associated ionospheric effects were investigated in an experimental program using the Arecibo Observatory's high-frequency ionospheric heating facility. The observatory's principal ionospheric diagnostic is an incoherent-backscatter radar, capable of measuring electron number density, electron and ion temperatures, ion composition, and upper atmospheric winds and conductivity. For these experiments, the radar diagnostics were supplemented by on-site ionosondes and photometers and an off-site coherent scatter radar. This radar, operating at 50 MHz with coherent scatter from 3-m irregularities, was located on St. Croix to study E-region short-scale field-aligned striations within the heated ionospheric volume.

An investigation of enhanced electron heating of the lower ionosphere was conducted at several frequencies. The radiated power flux was frequency-scaled SPS-equivalent, although wave absorption reduced the power density delivered as a function of altitude within the ionosphere. Electron-temperature increases of up to a factor of two were observed at 75-km altitude, in general agreement with current theoretical models.

Studies of wave self-focusing and plasma striation processes in the upper ionosphere were conducted for both over- and underdense ionospheric heating. For the underdense heating, no short-scale plasma striations were detected at either E- or F-region heights. Large-scale (kilometer-size) irregularities are commonly observed for overdense ionospheric heating. The measured growth times and scale sizes agree with thermal self-focusing theory. Preliminary results indicate that large-scale irregularities also developed during nighttime HF underdense ionospheric heating. These irregularities disappeared abruptly near sunrise. Density variations as large as 2% were observed within the irregularities, with a fading period of several minutes. It is not known if the irregularities result totally from HF self-focusing, or if they are an HF-triggered natural spread-F condition. Radio scintillations at 430 MHz were easily detected in association with overdense ionospheric-heating striations, but no effect was seen at 1410 MHz.

These results indicate that significant ionospheric effects can be generated by SPS-equivalent heating. However, they indicate that the current SPS microwave-beam power density design limit of 23 mW/cm^2 may be well below threshold for producing serious telecommunications impacts.

SPS HEATING IN THE LOWER IONOSPHERE, AN EXPERIMENTAL VIEW

Frank T. Djuth, David S. Coco, Daniel A. Fleisch and Suman Ganguly
Dept. of Space Physics and Astronomy, Rice University, Houston, Texas 77001

It is predicted that heating by the SPS microwave beam will substantially increase ambient electron temperatures and modify electron density distributions within the ionosphere. In the present study, the incoherent scatter radar at Arecibo Observatory is used to investigate enhanced electron heating in the D and E regions of the ionosphere and irregularity formation at E-region altitudes.

Initial tests for enhanced electron heating in the E region (95-115 km) were carried out in 1978 using the 430 MHz radar system at Arecibo. This system delivered heating pulses to the ionosphere having power densities of $\sim 1.5 \text{ mW/cm}^2$ at the center of the radar beam (SPS frequency scaled $\sim 50 \text{ mW/cm}^2$) at 100 km altitude. The lengths of the heating pulses ranged from 0.4 to 9.0 msec. The 430 MHz radar also served as the principal ionospheric diagnostic in the experiment. Radar signal power, backscattered from a short diagnostic pulse by free electrons in the ionosphere, was recorded as a function of altitude. By comparing power profiles before and after a radar heating pulse was transmitted changes in electron scattering cross section could be deduced. Because of the known temperature dependence of this cross section, the effective electron heating averaged across the beam could be determined. Typically, 100°K increases in electron temperature were observed yielding T_e/T_i values of ~ 1.5 at 95 km altitude. Following accurate treatments of the radar power distributions across the heating and diagnostic beams and subsequent improvements in the theoretical calculations, general agreement now exists between theory and these observations.

More recently, a series of observations designed to determine the amount of heating that occurs at D-region heights (60-95 km) have been performed. The observations utilized the 430 MHz radar as both a heater and a diagnostic in a manner similar to that described for E-region observations but with some notable changes. The experimental design necessitated that the length of the heating pulse be shortened to .2 msec. This was compensated for by the shorter rise times anticipated for electron heating in the D region. In addition, electron temperatures were deduced from measurements of the incoherent scatter frequency spectrum rather than total scattered power. These observations yielded values of T_e/T_i for D-region heating that peaked near $T_e/T_i = 2.5 \pm .5$ at an altitude of 72 km.

Finally, an additional series of D-region measurements were carried out at Arecibo using a new auxiliary HF (3-12 MHz) facility to heat the ionosphere. This facility was located 17 km away from Arecibo Observatory and was only partially completed at the time of the measurements. During the observations, the HF facility produced SPS frequency-scaled power densities of $\sim 5 \text{ mW/cm}^2$ near the center of a 5.1 MHz beam at an altitude of 75 km. The estimated power density takes into account absorption by ionization below 75 km but assumes a 100% radiating efficiency for the HF transmitter. Observations of D-region heating were conducted using an HF frequency of 5.1 MHz and X-mode polarization. In order to measure changes due to electron heating, the HF transmitter was repeatedly cycled on for 1 minute and off for 1 minute. Under these test conditions, maximum heating was observed near 75 km altitude, where T_e/T_i was found to be $2.1 \pm .5$.

In addition to the electron temperature measurements, the possibility that heating by an HF wave penetrating the E region might generate ionospheric irregularities was also examined experimentally. Unfortunately, at the time of these observations, the HF facility could be operated only in a pulsed mode

SPS HEATING IN THE LOWER IONOSPHERE, AN EXPERIMENTAL VIEW

Frank T. Djuth, David S. Coco, Daniel A. Fleisch and Suman Ganguly
Dept. of Space Physics and Astronomy, Rice University, Houston, Texas 77001

at a 50% duty cycle. A 2 msec pulse length and a 4 msec IPP was chosen for the observations. Azimuth scans using the 430 MHz incoherent scatter radar yielded no detectable cases of HF-induced irregularities in a heated E region. An upper limit for heater-induced irregularities was experimentally set at 5% in amplitude for irregularities having spacial scale sizes greater than 5 km.

In an effort to detect field-aligned irregularities having dimensions of ~ 3 m across the earth's magnetic field lines, a portable 50 MHz radar was set up on the island of St. Croix and operated in a backscatter mode. The 50 MHz radar was pointed in a direction perpendicular to the earth's magnetic field at an altitude of 105 km above the HF heating facility. The operation of the St. Croix radar was coordinated with measurements made at the Arecibo Observatory. During the St. Croix observations, the HF transmitter was restricted to pulsed operation at a maximum duty cycle of 50%. No heater-induced signal returns were apparent on an A-scope monitor, which was viewed while the 50 MHz radar was operated. On the basis of A-scope observations, an upper limit of 1 m^2 has been set for the total scattering cross section for irregularities produced by HF waves penetrating the E region. The sensitivity of the experiment to scattering will be increased 2-3 orders of magnitude following detailed processing of the data.

LABORATORY AND PROPOSED IONOSPHERIC EXPERIMENTS ON SPS MICROWAVE INSTABILITY*

P. Le-Cong, D. Phelps, J. Drummond

Power Conversion Technology, Inc.

11588 Sorrento Valley Rd., #18, San Diego, California 92121

R. Lovberg, W. Thompson

Dept. of Physics, Univ. of California at San Diego, CA. 92093

Laboratory Experiments

Thermal self-focusing theory predicts that the overall effect of the interaction between the ionospheric plasma and the satellite power beam would be amplification of naturally occurring electron density striations. The theory has been extended to include laboratory conditions: a 6 ms pulsed, 0-3 kW, 2.45 GHz beam focused with a 0.5m x 0.6m horn and variable lens onto a 0.7m diameter window of a 1m x 2.5m Helium-Argon plasma produced by a 0.5m x 2m cross-section, 100 kV, ~100A electron beam. Provision is made to spatially modulate the e-beam to produce density striations about currently measured densities of up to $\sim 2 \times 10^9$ e/cm³. Even without this pre-modulation, preliminary measurements indicate a dependence of phase on microwave power that is a key phenomenon predicted by thermal instability theory. The measurements were made at power levels below the point where the microwave ionization affected the Langmuir probe measured plasma density. The experimental approach and important results are described below.

The experimental system shown in Fig.1 is now in full operation at Power Conversion Technology, Inc. The microwave oven magnetron and PCT power supply have produced up to 3 kW power in 6 ms pulses with a 60 Hz rep-rate. The 50cm x 60cm horn fabricated by PCT has a voltage standing wave ratio of only 1.15 and produces the expected free space radiation profiles. The adjustable 100 cm focal length dielectric lens fabricated by PCT has been used to reduce the effects of reflections from the walls of the tank.

The plasma is formed by pulse ionizing a typically 5 Torr Helium-10 micron Argon gas with a 50cm x 200cm 100 kV electron beam. As observed from light excitations in the 2 mil aluminized mylar anode window, the beam is fairly uniform. The Langmuir probe traces (at several different bias voltages to identify saturation) indicate a peak electron density of 2×10^9 e/cm³.

A microwave interferometer was assembled that was similar to that shown in Fig.2, except that the reference diode antenna was located at the entrance to the plasma chamber. A good null was observed except for the rising and falling portions of the pulse -- evidently due to frequency chirping in the magnetron.

When a 3 kW microwave beam was turned on with or without the e-beam, the microwave power was sufficient to enhance the plasma density -- as observed by Langmuir probe, interferometer amplitude and phase modifications, and the presence of plasma light near the entrance to the tank.

Another phenomena noted when the e-beam and microwave beam were pulsed in sync was the observation of pulsed plasma light along the length of the chamber at the ~1 Hz rep-rate of the e-beam. The e-beam was triggering the scope and fiducialing itself as a positive RC blip on the microwave amplitude and phase detectors, after which modifications due to the plasma were observed on both interferometer and Langmuir probe data.

In the theory of thermal instabilities, the phase shift produced by instability should depend on the beam power. As a check on this, the system was operated at different power levels, where the power was attenuated by putting

* Most of this work is supported by the U.S. Department of Energy.

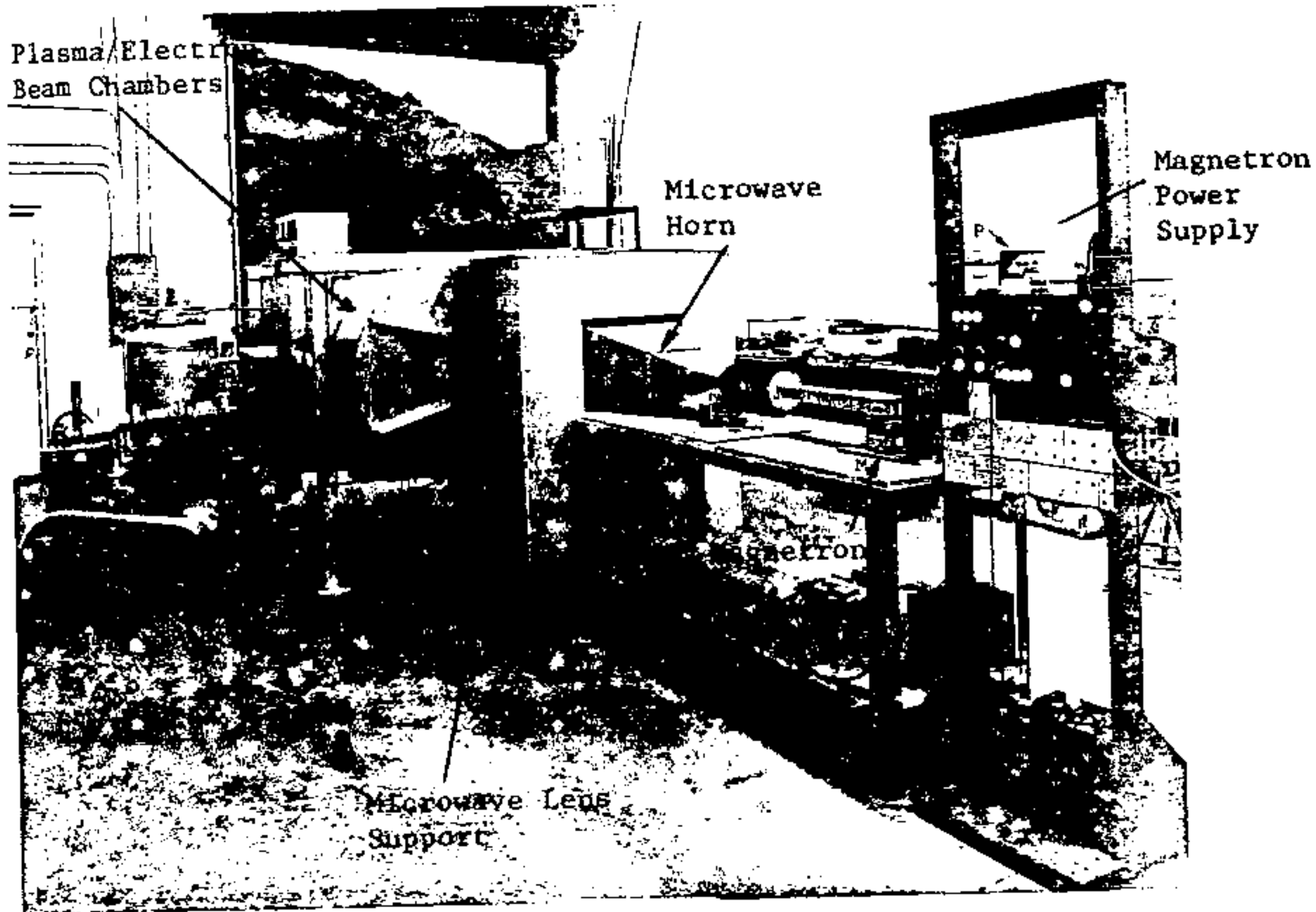

Figure 1

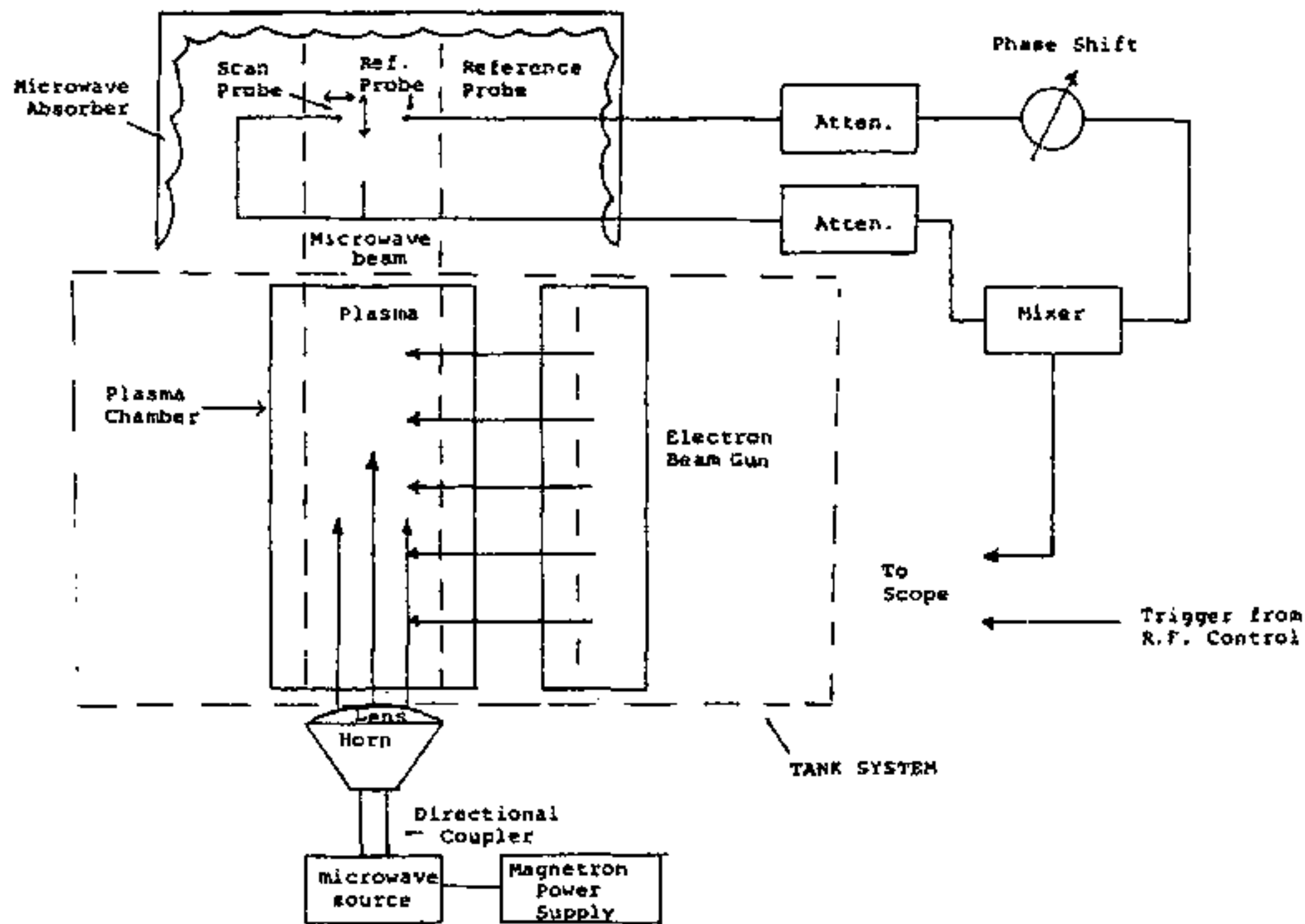

DIAGRAM OF LABORATORY SIMULATION EXPERIMENTS OF IONOSPHERIC THERMAL INSTABILITIES

aquadag coated cardboard (with fan cooling) in the plane of the horn.

The key results are shown in Fig.3. The upper traces are the beam amplitude profile and the lower traces are Langmuir probe measurements of the plasma decay. Note at the 3 kW level (upper photo) the microwave beam modifies the plasma, while at 380 W and 340 mW there is no change in the plasma density produced by the e-beam. A phase shift of 75° (averaged over the 6 ms pulse) was observed between the 340 mW and 380 W power levels -- evidently due to the microwave beam power modulating the plasma density and being deflected by the modulation. The measured 75° phase shift if uniform would represent doubled peak plasma density of 2×10^9 e/cm³; since there was no appreciable change observed on the Langmuir probe characteristic, such a change apparently did not occur.

Proposed Ionospheric Experiments.

In the ionosphere at SPS power level¹, the instability growth process favors spatial wavelengths of order 50 m^1 , but so far diagnostic techniques have been limited to spatial resolutions of much larger scale. A new technique which is reviewed should yield high spatial resolution. Spatial gain as a function of beam power level for various spatial wavelengths can be determined by measurements of phase distribution of a microwave beam propagating upward through the underdense ionosphere. The high spatial resolution is to be accomplished by rapidly moving the detector aboard a satellite across the near field of the beam refracted by electron density striations, as shown in Fig. 4.

¹ J.E. Drummond, 4th Princeton Conf. on Space Mfg. Facilities (May 1979).

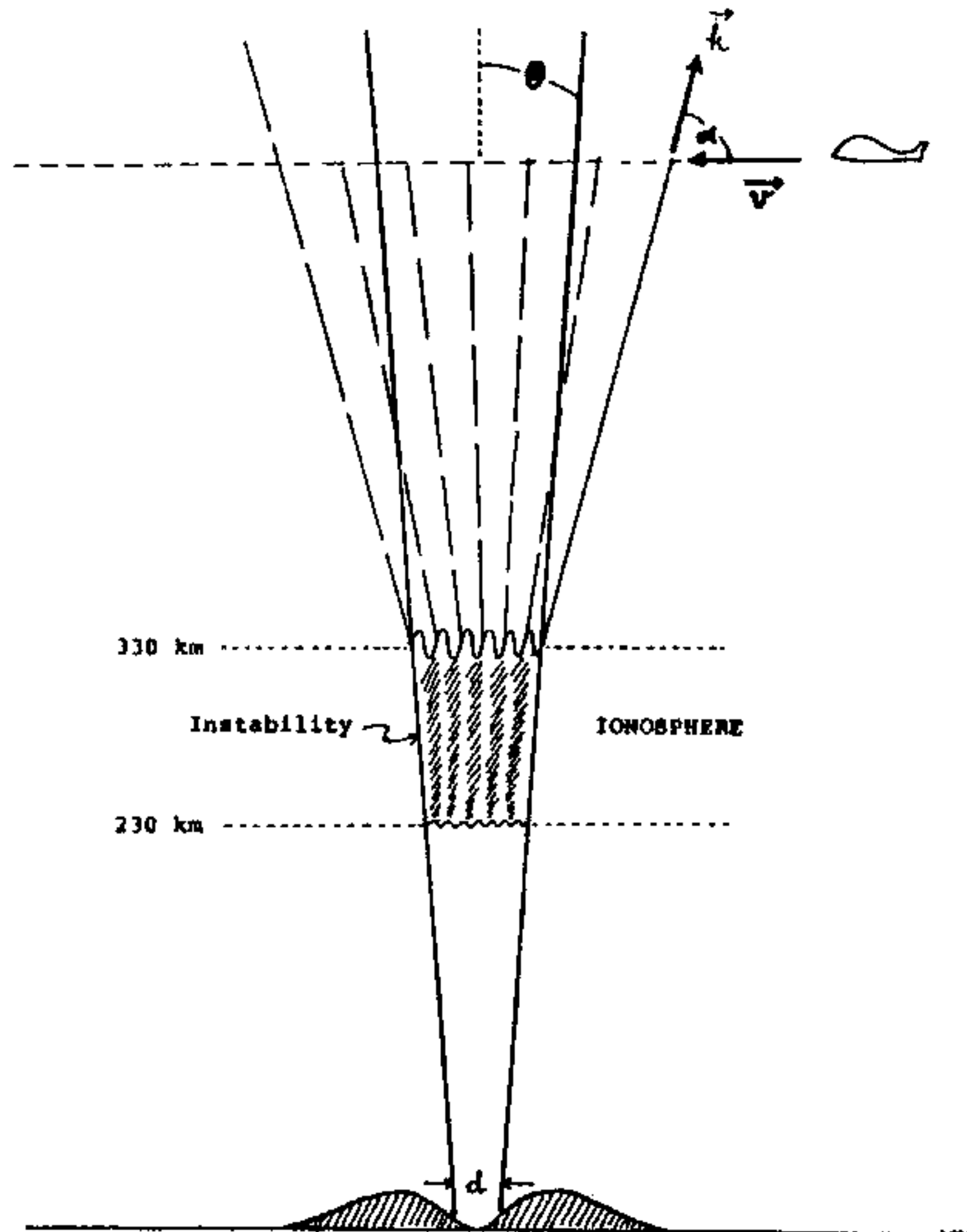
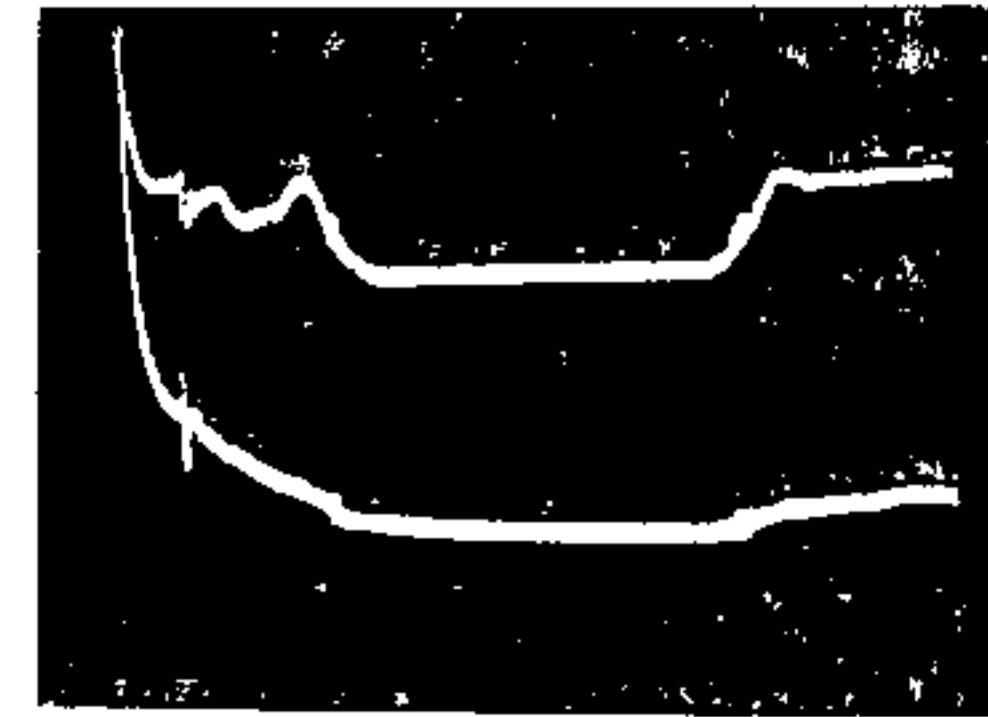
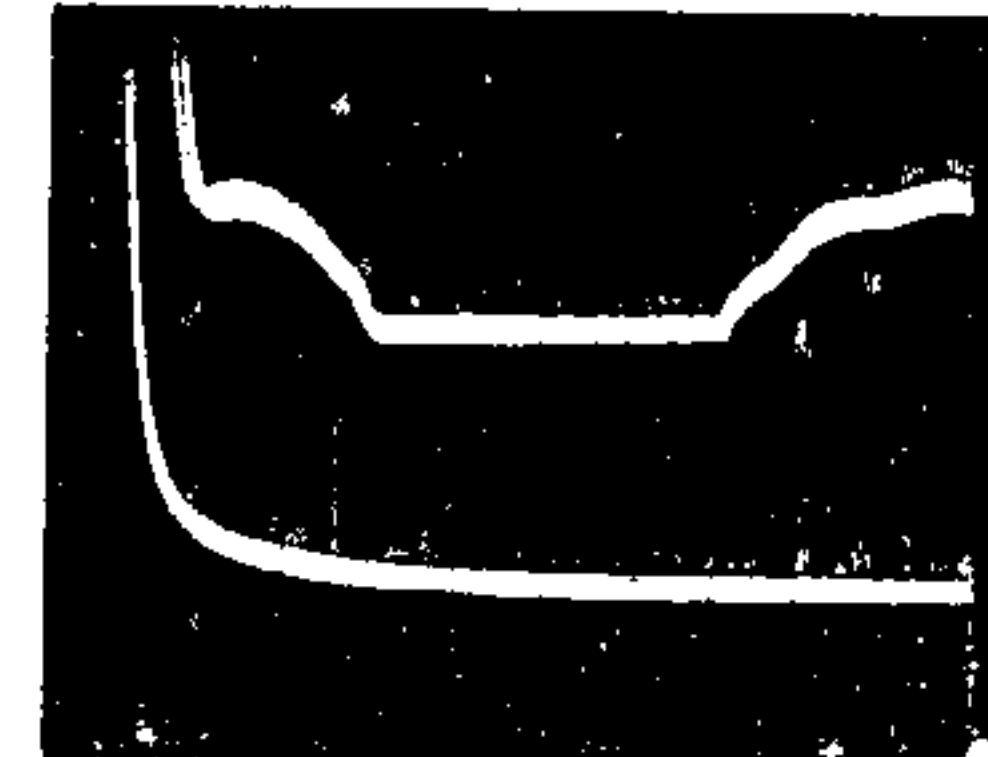

Figure 4



3 kW

2 ms/div

 $2 \times 10^9 \text{ cm}^{-3}$ 

380 W

2 ms/div

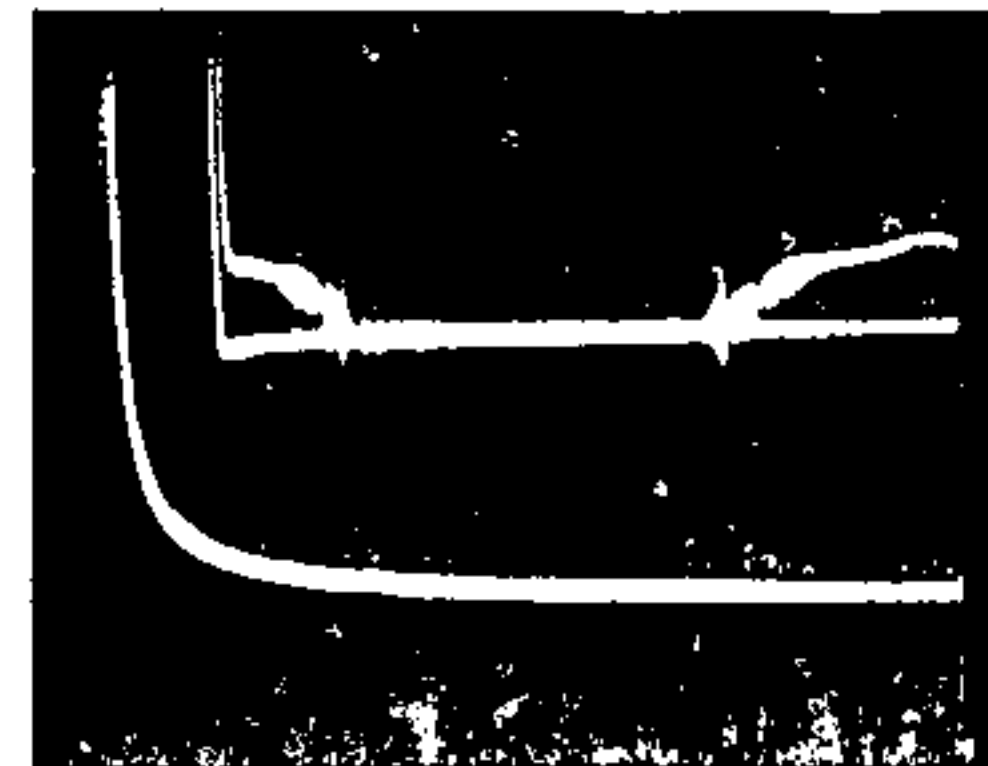
 $2 \times 10^9 \text{ cm}^{-3}$ 

340 mW

2 ms/div

 $2 \times 10^9 \text{ cm}^{-3}$

POWER DEPENDENT 75° PHASE SHIFT NOTED -- NO PLASMA DENSITY
MODIFICATION -- SHOWN IN MIDDLE AND BOTTOM PHOTOGRAPHS.

Figure 3

SUMMARY OF THE ELECTROMAGNETIC COMPATIBILITY EVALUATION OF THE
PROPOSED SATELLITE POWER SYSTEM

E. L. Morrison, Jr. and W. B. Grant

U. S. Department of Commerce, NTIA/ITS, Boulder, Colorado 80303

K. C. Davis

Battelle Memorial Inst., Northwest Laboratories, Richland, WA 99352

The EMC Evaluation program concerns the effects of the proposed SPS operations on electronic equipment and systems by fundamental, harmonic, and intermodulation component emissions from the orbital station; and the fundamental, harmonic, and structural intermodulation emissions from the rectenna site. With each satellite transmitting a power of 6.85 GW, and the reference design including 60 satellite-rectenna systems, the coupling and affects interactions encompass a wide spectrum of electronic equipments.

The primary EMC tasking areas are listed.

1. Describe the ranges of beam distortion expected because of troposphere scatter and refraction anomalies. Short term transient modes are included to support beam control system stability and pointing dynamics, and short term interference events during periods of storm front passage or high density anomalies.
2. Evaluate the modes of SPS power coupling into susceptible systems, and the induced functional degradation.
3. Relate susceptible system performance effects to operational applications (e.g., air traffic control, utility/pipeline command/control military test range and operations instrumentation and command/control, GEO and LEO satellites, and network throughput priorities) to identify specific sets of safety and operational effectiveness impact areas.
4. Evaluate mitigation techniques to assure an acceptable performance for affected systems in SRS environments. Specify rectenna site-susceptible system separations for the rectenna siting project area for situations where safety risks, political sensitivities, and mitigation effectiveness uncertainties dictate.
5. Develop cost factor data; susceptible system investment and mitigation incremental costs related to applications and geographic areas in CONUS.
6. Evaluate beam transmission and spacetenna-rectenna characteristics for other SPS frequency alternatives.

The EMC evaluation methodology is illustrated by the data flow diagrammed in Figures 1 and 2. In Figure 1, the rectenna site input refers only to the testing of specific site candidates relative to EMC variables. All susceptibility testing was site independent so as to be maximally useful to siting studies and mitigation trade-off analyses.

The susceptible system categories evaluated are indicated in Figure 3. These are coupled to applications as indicated in Figure 4. Time line and decision event procedures are employed to identify operational impacts relative to affected system performance effects.

The principal types of systems tested with associated performance measures are summarized in Figure 5. Typical performance effects for SPS power densities within 100 km of the rectenna edge ($\sim 1 \text{ mw/cm}^2$) for microwave FDM communications, instrumentation radar, and high resolution plumbicon cameras are presented in Figure 6. These data were derived as part of an examination of the utility of a candidate rectenna site in the Mojave Desert. Performance scores for all systems evaluated included fundamental power densities over the range of $0.1 - 1 \text{ mw/cm}^2$, and $10^{-7} - 10^{-4} \text{ mw/cm}^2$ for harmonics. These ranges are typical of sets of scores that provide a continuum of performance measure-SPS interference ratio responses which guide the priorities for functional mitigation.

Sensors employed for satellites include high resolution vidicons, image dissectors, charge coupled devices, and IR scanners. These are utilized for mapping, speedometry, attitude control, and transient event detection as required for LANDSAT, NAVSTAR and surveillance operations. Performance criteria affected by passage through the SPS power beam include video noise, spatial resolution, and video dynamic range. Guidelines for future satellite developments address mitigation methods for optical sensors, communications, and special purpose RF sensors (monostatic and bistatic holographic radar, synthetic aperture radar).

GEO satellite interference areas include communication relays (COMSTAR, INTEL-SAT, DSCS), future switching and processing satellites (computer controlled spotbeam operations), and satellite-satellite spotbeam modes. The latter includes the interference caused by SPS reflective multipath; identifying the necessity for a frequency offset transponder on the SPS vehicle to eliminate the effects of the SPS reflection component.

Mitigation techniques include antenna pattern control, cable and module shielding, single point grounding methods with low resistance connections, and modification of module interface circuitry and transient protector circuits. For terrestrial and aircraft communications, radars, sensors, and computer/processors, these methods restore capabilities to the 96-100% range. More specialized shielding and procedural modifications are required for LEO and GEO satellites. Mitigation techniques being investigated for radio astronomy equipment include cryogenic rejection filters, and interference cancellation in the preamplifier waveguide or coaxial cable.

Rectenna site-susceptible system separation distance categories for positive and potential exclusions have been specified where dictated by safety and sensitivity considerations; 150 km for military OT&E and radio astronomy sites, 100 km for air and missile defense sites and radar astronomy facilities, 60 km for military development test ranges and ATC sites, and 50 km for nuclear and optical astronomy facilities.

An evaluation of possible alternative frequency ranges for the SPS covers the range of 2.45-30 GHz. Parametric displays of spacenna and rectenna area, attenuation, and refraction and scatter losses are being developed. Spacenna far field criteria varying from a maximum distance of $2D^2/\lambda$ are played into the sizing exercises to determine a range of minimum rectenna areas.

Technical reports provide details for the performance effects and operations evaluation, satellite operational impacts, SPS power densities at fundamental and harmonic frequencies over CONUS and the western hemisphere, system investment and mitigation cost factors, and Design Guidelines to assist future system development.

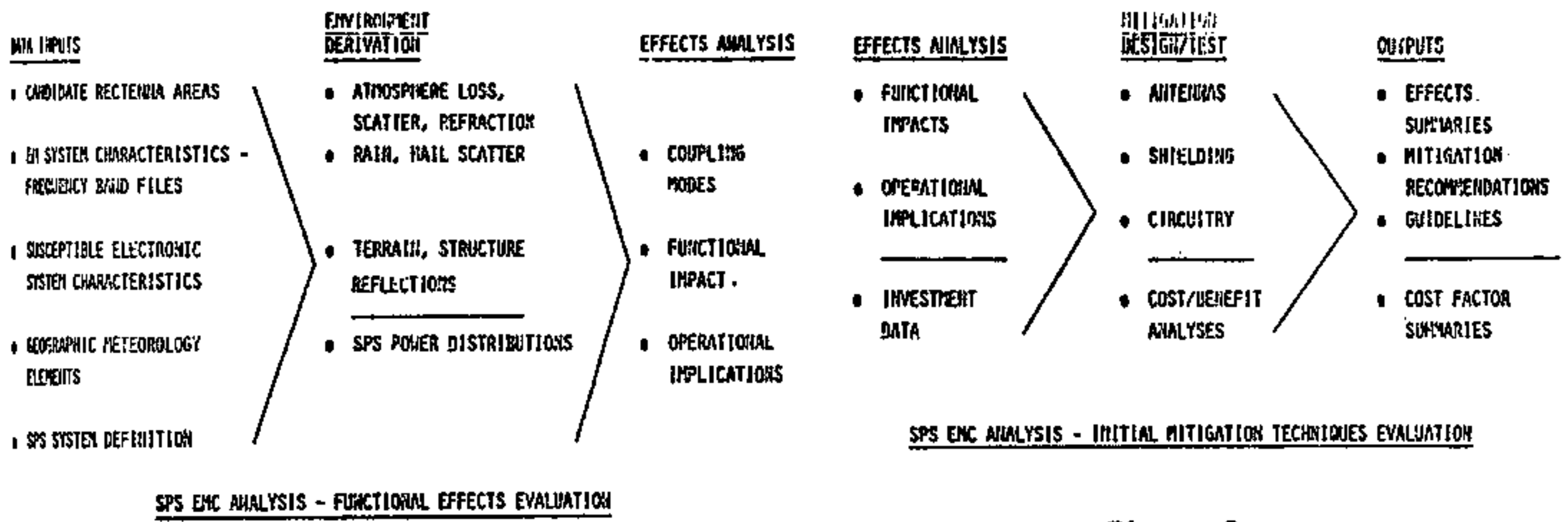

Figure 1.

Figure 2.

- EMC EFFECTS ANALYSIS - SYSTEM CATEGORIES**
- ..COMMUNICATIONS--**
SATELLITE, SURFACE
COMMON CARRIER NETS,
DEDICATED SERVICE NETS
 - ..RADARS--**
AREA SEARCH/MONITOR,
TRACK/CONTROL
 - ..NAVIGATION--**
LORAN/SHORAN,
SATELLITE
 - ..BROADCAST SERVICES--**
DOMESTIC/INTERNATIONAL
AM, FM/TV
 - ..RECREATION SERVICES--**
AMATEUR, CB
 - ..COMPUTERS--**
CENTRAL SERVICE SYSTEMS,
DISTRIBUTED MINI/MICRO
SYSTEMS
 - ..SENSORS--**
TV/IR MONITORS, EM
INTRUSION ALARMS
 - ..MEDICAL EQUIPMENT--**
CLINICAL DIAGNOSTICS,
BIOTELEMETRY, HEART
PAGERS
 - ..RESEARCH SUPPORT--**
PHOTOMETRY, RADIO
ASTRONOMY

Figure 3.

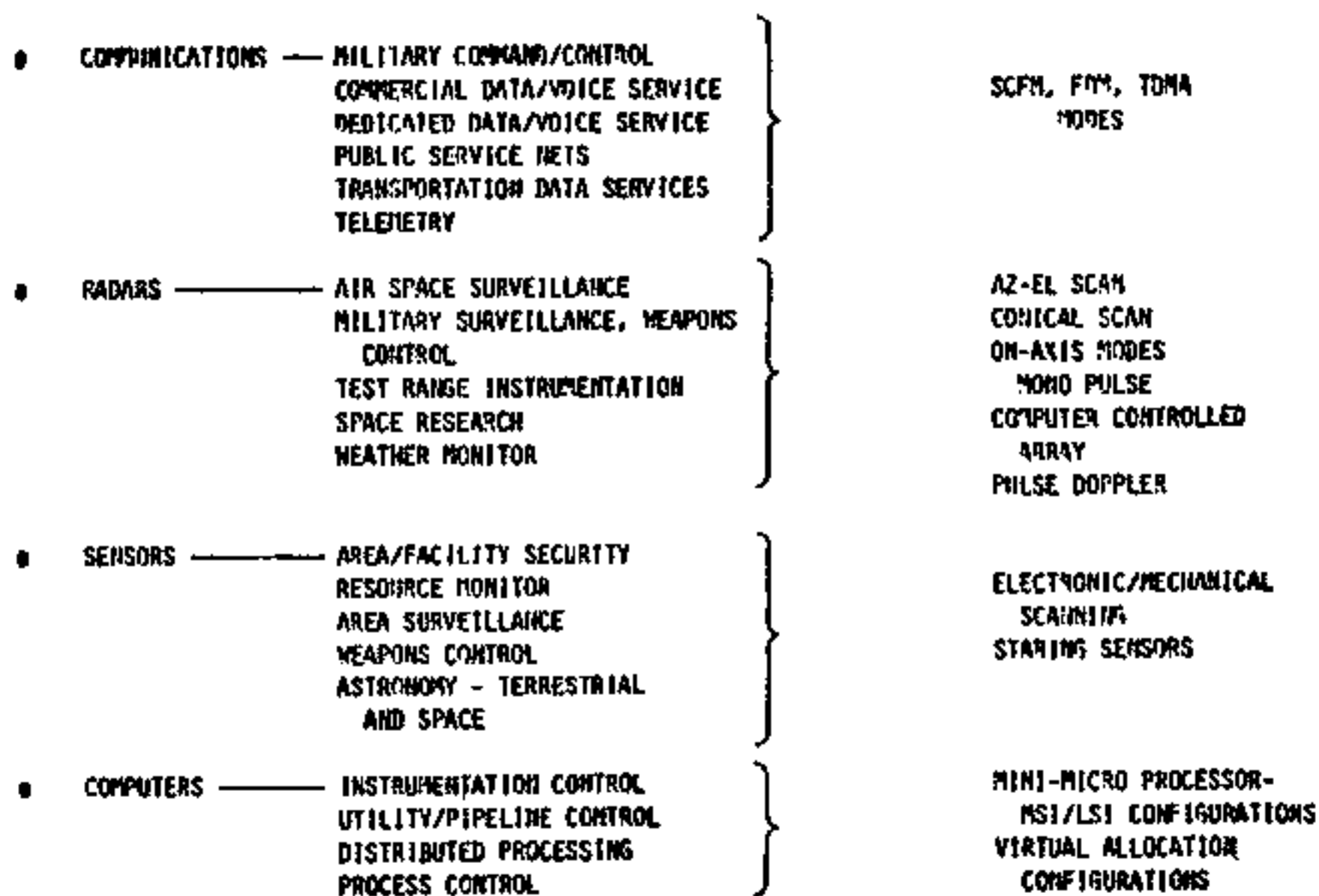

Figure 4.

- TARGET DETECTION RANGE
- TARGET ID DELAYS
- TRACK ACQUISITION DELAYS
- TRACK ERROR
- BEAR CONTROL INSTABILITY

RADAR PERFORMANCE CRITERIA

- SIGNAL ACQUISITION DELAY
- BER - SYNC, ADDRESS, DATA EFFECTS
- MUX NOISE

COMMUNICATIONS PERFORMANCE CRITERIA

- I/O CHANNEL NOISE
- CONTROL NOISE - PULSE JITTER
- MULTIPoint ROUTINE ERRORS

COMPUTER PERFORMANCE CRITERIA

- VIDEO CHANNEL NOISE
- SCAN JITTER
- DYNAMIC RANGE REDUCTION
- RESOLUTION REDUCTION
- DISCRIMINATION FEATURE UNCERTAINTIES

SENSOR PERFORMANCE CRITERIA

Figure 5.

FUNCTION	CHARACTERISTIC EFFECT
COMMAND/CONTROL AND TELEMETRY COMMUNICATIONS (MILITARY TEST RANGES)	<ul style="list-style-type: none"> a. SIGNAL ACQUISITION THRESHOLD: +5 TO 20% b. DATA ERROR: +5 TO 28% c. SYNC LOSS PROBABILITY: +3 TO 25%
UTILITY AND PIPELINE COMMAND/CONTROL/TELEMETRY COMMUNICATIONS	<ul style="list-style-type: none"> a. SIGNAL ACQUISITION THRESHOLD: -5 TO 15% b. DATA ERROR: +10 TO 30% c. LINK NOISE: +5 TO 20%

MOJAVE RECTENNA SITE ANALYSIS - SYSTEM IMPACT DATA

<u>FUNCTION</u>	<u>CHARACTERISTIC EFFECT</u>
INSTRUMENTATION RADAR (MILITARY TEST RANGES)	<ul style="list-style-type: none"> a. COOPERATIVE TARGET ACQUISITION RANGE: -8 TO 20% b. SKIN TARGET ACQUISITION RANGE: -13 TO 28% c. COOPERATIVE TARGET TRACK ERROR: +15 TO 40% d. SKIN TARGET TRACK ERROR: +22 TO 65% e. LOSS OF TRACK LOOP LOCK (SKIN MODE) PROBABILITY INCREASE: +10 TO 40%

MOJAVE RECTENNA SITE ANALYSIS - SYSTEM IMPACT DATA

Figure 6.

THE EFFECTS OF A SATELLITE POWER SYSTEM ON GROUND-BASED ASTRONOMY

A. R. Thompson

National Radio Astronomy Observatory*, P. O. Box 0, Socorro, NM 87801

Bands allocated to radio astronomy occur at roughly octave intervals across the radio spectrum. Threshold levels for harmful interference in these bands are specified in CCIR Report Number 224-4, and are based upon observations with a single antenna which are the most sensitive observations to radio interference. They also assume reception of an unwanted signal in sidelobes of 0 dBi gain. These levels for the principal radio astronomy bands are shown in Figure 1.

In considering the effects of the SPS on radio astronomy the following components of the SPS spectrum must be included.

The Power Signal The typical level at an observatory not nearer than 100 km to a rectenna is estimated to be 0.01 Wm^{-2} , increasing by 5 dB if phase lock is lost at a satellite. This level, received in 0 dBi sidelobes of radio telescope, produces a signal of 10^{-5} W which is 35 dB above the overload threshold for a typical parametric amplifier, or 10 dB above the overload threshold for an FET amplifier. At present most radio astronomy receivers contain little or no filtering between the antenna and the first amplifier stage, to avoid the noise resulting from loss in ambient temperature filters. Cryogenically cooled filters, when developed, will prevent overload from the SPS power signal with little loss in sensitivity for most bands other than 2.69-2.70 GHz and 4.99-5.0 GHz. In these last two bands, which are close to the power signal and its second harmonic, impaired performance is likely to result.

Harmonics of the Power Signal Of several harmonics that fall close to radio astronomy bands the second presents a serious problem since it is likely to cause overloading when antennas are pointed close to the satellites.

Transmitter-Generated Noise Bands of noise generated by the power transmitting system will be centered on 2.45 GHz and low-order harmonics. For klystrons, Arndt and Leopold (1978) estimate that the noise should be less than the CCIR-224-4 level in the 2.69-2.70 GHz band. Crossed-field tubes and transistors are also being considered as power generating devices and may have significantly different noise properties.

Thermal Noise From The Collector Arrays The collector array on each satellite subtends a maximum solid angle of 0.5 sq arcmin at the earth and operates at a temperature of approximately 360 K. The thermal emission from 60 satellites, assuming unit emissivity is shown in Figure 1 for an observer's local midnight when the 60 satellites appear most nearly broadside-on. The actual emissivity of the cell arrays is not known, but probably results in a flux density level 3 to 10 dB lower than shown in Figure 1, i.e., very close to the CCIR 224-4 levels. Thus, for pointing angles closer than the separation of the 0 dBi sidelobe level from the main beam of the radio astronomy antenna, interference can occur.

Intermodulation Products Intermodulation products are to be expected from interaction of the power signal in nonlinear elements such as corroded joints in towers and fences, receiving systems and possibly the ionosphere. Widely distributed signals such as television broadcast signals are most likely to be

*The National Radio Astronomy Observatory is operated by Associated Universities, Incorporated, under contract with the National Science Foundation.

involved.

Failure Related Signals With 6×10^6 tubes in orbit, a tube lifetime of 220,000 hours results in 26 failures per hour. Some failures may be associated with increased noise, development of parasitic oscillations or phase-lock failure. Klystrons are believed to be much less likely to produce such unwanted emissions than other types of microwave-generating devices. However, since so many units are involved, relatively rare failure modes will occur. Life testing of a large number of units is required to evaluate this effect.

Rectenna Radiation Some incident power will be reflected from the rectennas (Arndt and Leopold 1978) and noise and harmonics will be generated in the rectification process. The mean distance between 60 rectennas within the U.S. will be about 350 km. Choice of rectenna sites must make use of mountain ranges to obtain adequate isolation of observatory sites.

Synthesis arrays in which the signals from many antennas are combined in pairs to produce maps of the sky with high angular resolution are less susceptible to radio interference than single-antenna radio telescopes by factors that range from 10 to 40 dB depending upon the frequency, antenna spacing, bandwidth and other observing parameters (Thompson 1979). Observations using very long baseline interferometry (VLBI) are the least susceptible of all to radio interference (Burke 1979). Thus in Figure 1 the area between the lines marked VLBI and CCIR 224-4 represents the range of harmful interference thresholds for the various types of radio astronomy instruments. Unfortunately synthesis arrays and VLBI systems are not applicable to all types of astronomical investigations.

The principal effects of the SPS on radio astronomy can be summarized as follows. (1) For any type of radio astronomy system there will be an angular distance from the satellites within which harmful interference will occur. The width of this precluded zone depends upon various parameters of the observing instrument and is estimated to vary from 20° for a single antenna to a few degrees for a VLBI system. (2) For the 2.69-2.70 GHz and 4.99-5.00 GHz radio astronomy bands sufficient filtering to prevent overloading by the power signal or its second harmonic may not be achievable without significant impairment of sensitivity resulting from filter insertion loss. (3) Conflicts between site requirements for observatories and rectennas are likely to occur.

The above three effects represent the minimum likely interaction with radio astronomy, and are sufficient to cause significant restrictions. The effects of intermodulation products and failure-related signals discussed above could be much more serious, but should be more amenable to mitigation. The quality of SPS engineering and maintenance appears crucial to the coexistence of radio astronomy.

Radar astronomy, like radio astronomy, uses large antennas and highly sensitive receivers. Interference effects (David 1979) differ from those for radio astronomy chiefly in the following ways. (1) Bandwidths are usually much less than in radio astronomy, resulting in harmful thresholds 10-40 dB higher than the CCIR 224-4 levels. (2) 2380 MHz is an important frequency, particularly at the National Astronomy and Ionosphere Center, Arecibo, Puerto Rico. This is so

near to the SPS power frequency that impairment of sensitivity will result. (3) Radar astronomy targets lie close to the ecliptic, and antenna pointing angles will generally be within 30° of the geosynchronous orbit.

In optical astronomy the effects of the SPS result mainly from the increase in sky brightness caused by diffuse reflection of sunlight from the satellites and subsequent scattering of the light in the earth's atmosphere. The effects are discussed in several papers in the report of the Battelle Workshop on Satellite Power Systems Effects on Optical and Radio Astronomy. They are difficult to quantify precisely because there is at least a factor of two uncertainty in the diffuse albedo of the satellites and the atmospheric scattering depends to some extent upon atmospheric conditions. In a zone 10° to 20° wide centered on the satellites, light contamination will cause impaired performance that cannot be compensated for by increased observing time. Noticeable effects will be seen over a band of sky at least 60° wide. The effects on ground-based optical astronomy are probably more severe than upon radio astronomy.

References

- Arndt, G. D. and Leopold, L., 13th Intersociety Energy Conversion Engineering Conference, San Diego, CA, August, 1978.
- Battelle Workshop on Satellite Power Systems Effects on Optical and Radio Astronomy, Seattle, WA, May, 1979. Report edited by G. M. Stokes and P. A. Ekstrom is being published by the U. S. Department of Energy and NASA.
- Burke, B. F., 1979, in Battelle Workshop Report.
- Davis, M., 1979, in Battelle Workshop Report.
- Thompson, A. R., 1979, in Battelle Workshop Report.

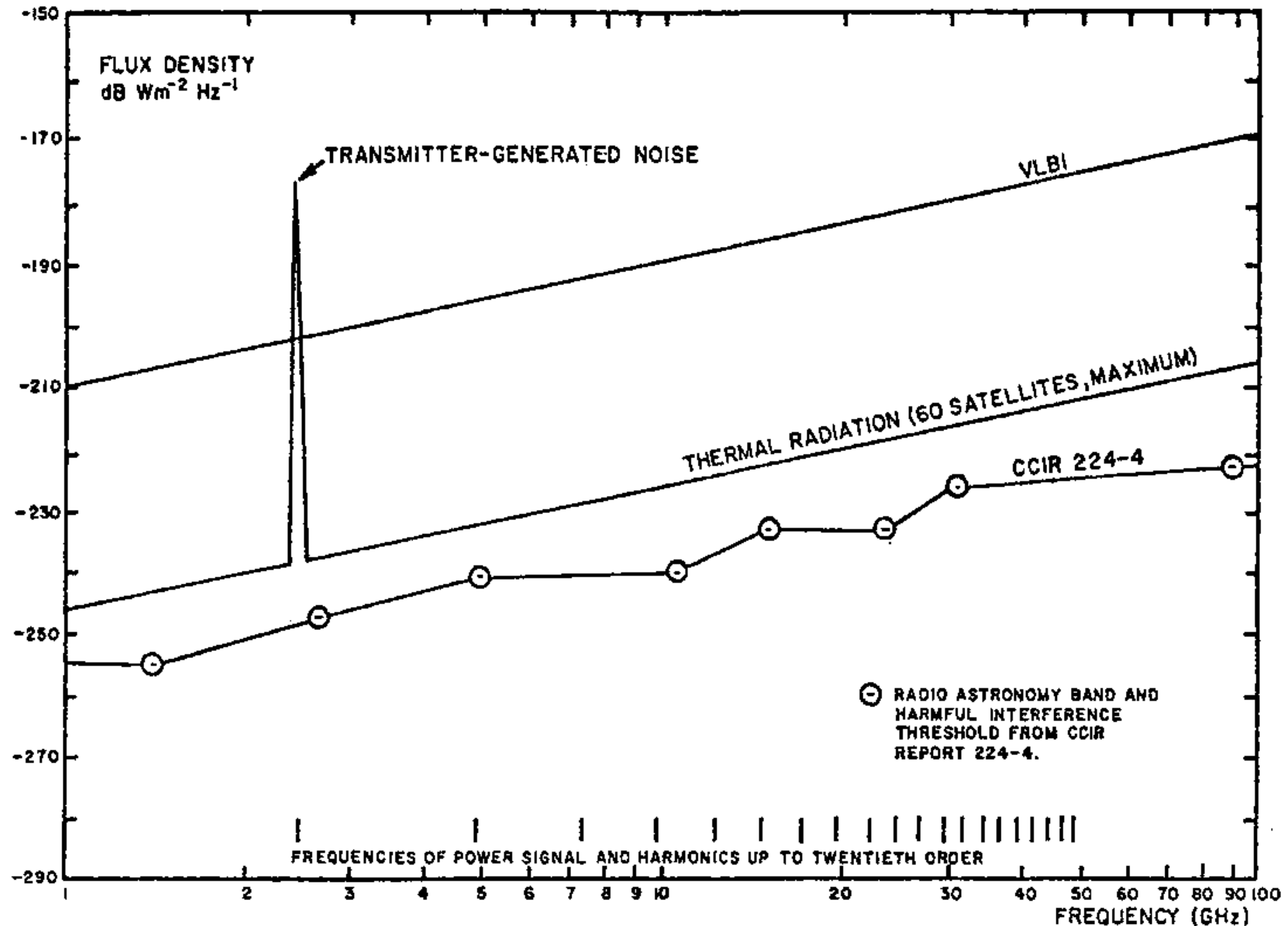

Figure 1: The spectrum of radiated noise from the SPS compared with harmful thresholds for radio astronomy. The line defined by the CCIR 224-4 points represents the harmful threshold as a function of frequency for total-power observations with single-antenna telescopes, which are the type of observations most sensitive to radio interferences. The line marked VLBI is from Burke (1979) and represents the threshold for observations using Very Long Baseline Interferometry which are the least sensitive to interference. The area between the CCIR 224-4 and VLBI lines represents the range of harmful thresholds for different types of radio astronomy instruments, when interference is received in antenna sidelobes with gain 0 dBi. The transmitter-generated noise at 2.45 GHz is from Arndt and Leopold (1978) and applies to klystrons. Similar bands of lesser amplitude will occur at the low-order harmonic frequencies.

SPS EFFECTS ON OPTICAL ASTRONOMY

G. J. Schuster

Pacific Northwest Laboratory, P. O. Box 999, Richland, WA 99352

Some of the passive properties of SPS are likely to have a negative impact on optical astronomy. Principally, SPS may increase the brightness of the night sky.

The earth's atmosphere is the medium for the damage done to an astronomical observation by a bright object in the night sky. Although the cloudless sky is mostly transparent at optical frequencies, the atmosphere scatters some light. Although observatories are located where meteorological conditions are such that "seeing" is good, observations of faint objects are currently limited by interfering light. When this light is collected by a telescope, it constitutes a noise signal and must be subtracted by observing a nearby section of "blank" sky. Any increase in sky brightness over the natural background results in a proportional reduction in the effective aperture of a telescope being used to observe faint objects.

Each solar power satellite is oriented so that the solar cell array approximately faces an observer at the subsatellite point at local midnight. Using this situation and assuming a Lambertian pattern for the scattered light, the expected illuminance at the earth's surface, expressed as a fraction of noon sunlight is $a\Omega_s/\pi = 1.38 \times 10^{-5}a$ where a is the diffuse albedo and Ω_s is the solid angle subtended by the satellite.

Using an estimate for the diffuse albedo of 4%, a satellite would be as bright as the planet Venus ever is. SPS satellites would be the third brightest objects in the sky, only the sun or moon would be brighter. The set of 60 satellites would have the illuminance of the moon halfway between new and quarter phase.

For a 60-satellite system, the sky brightness may be doubled in a region 10° in declination and 70° in hour angle. The sky brightness may be increased by 10% over a region that covers half the night sky. If this is the case, due to the geostationary orbit of the satellites, a significant number of faint objects will not be able to be observed.

Finally, it must be noted that the development of the technology required for SPS should make it easier to construct and maintain space telescopes. It is widely recognized that a great deal of the future of astronomy will depend on developing space astronomy beyond current and planned levels and that some kinds of astronomy can only be done from space.

THE EMC OF SATELLITE POWER SYSTEMS AND DoD C-E SYSTEMS

James H. Atkinson

DoD ECAC - Annapolis, Maryland

Marvin D. Aasen

IIT Research Institute - Annapolis, Maryland

The Department of Defense (DoD) is vitally interested in the satellite power system (SPS) concepts presently being proposed, since electromagnetic spectrum sharing would be required with many military C-E systems. The objective of this discussion is to present the DoD Electromagnetic Compatibility Analysis Center's (ECAC) technical understanding of the SPS and to assess the potential electromagnetic impact on existing DoD operations in the southwestern portion of CONUS. This geographical area is of principle concern because of the likelihood of SPS earth rectenna locations.

First, those SPS technical parameters that are needed to accurately assess the EMC between SPS systems and DoD communications-electronics (C-E) systems are identified. Next, the assessment is performed by: presenting the type of electromagnetic interactions that could degrade the performance of C-E systems; identifying the major military installations in the southwestern portions of CONUS where specially sensitive C-E systems are being used for combat training and evaluation; identifying classes of C-E systems that are generally in the vicinity of these military installations; identifying those technical parameters that govern the degree of compatibility of the SPS with these C-E systems; and identifying some technical requirements that are necessary to ensure short-term and long-term EMC.

Electromagnetic interference from the satellite microwave power transmissions will depend upon the characteristics of power in and near the carrier, harmonics, noise frequencies, and the antenna beam pattern offered by each of these. Scattering and reradiation of the satellite transmitter frequencies at the earth receiving rectenna and the effect of the rectenna directivity pattern is not covered in this evaluation. Interaction of these signals with DoD equipments potentially could degrade their performance. Table 1 presents a list of general C-E system types, their corresponding degradation criteria, and associated interference thresholds.

Southwestern CONUS is the most likely geographical area for SPS earth location(s), especially for prototype equipment. Major DoD test range, training facilities, and military bases are identified in this geographical area to illustrate proximity to potential SPS sites. Two of these DoD facilities are examined to illustrate the extent of C-E systems, types, quantity, and the potential EMC issues of concern. Areas examined are those at the Tactical Fighter Weapons Center (TFWC) at Nellis AFB, Nevada, and the National Training Center (NTC) at Fort Irwin, California. The mission of the TFWC is to develop, maintain, and operate a DoD major test and training facility for the use of all DoD components. The mission of the NTC is to train and evaluate U.S. Army arms units in a realistic tactical and electronic countermeasures environment. At

each of these two geographical sites, the general type of DoD C-E system such as voice communications, telemetry, radar, etc.; the C-E system function (e.g., air traffic control, mobile communications, research radar, etc.); along with the expected range of system parameters such as receiver sensitivity, bandwidth, and antenna gain are examined.

Basic calculations of power levels of the SPS transmission at DoD C-E system receivers indicate interaction with the carrier and with the harmonics of the carrier. Calculations are based on SPS technical characteristics as given in Reference 1. Such interactions can be greatly reduced by limiting operation of C-E systems to certain frequencies and maintaining distance separations. For example, based on expected sensitivities of C-E systems at the DoD locations and their associated antenna gains, in-band (SPS carrier) EMC will be achieved when frequency separation (Δf) ≥ 50 MHz and a distance separation of more than 25 km exists between the SPS satellite transmitting antenna pattern and the DoD C-E receiving system. In the case of harmonics (the out-of-band case), assuming the harmonics being 100 dB below the carrier, a $\Delta f > 20$ MHz and a distance separation of more than 25 km are necessary. A number of factors are not included in these calculations, however, that could potentially result in operational constraints that are much more restrictive. Component aging (degradation) may affect both satellite radiated carrier spectrum and antenna beam formation. The element pattern of the array at the harmonics is not known and most certainly will be different than that at the carrier frequency. Hence, the antenna pattern (including harmonic grating lobe positions) will be different than that of the fundamental frequency. Further study and measurements in these areas are required.

Noise frequencies radiated from the SPS satellite transmitter and the scattering and reradiation of frequencies at the earth rectenna could present a potential EMC problem to DoD C-E systems if not controlled. For example, in the SPS antenna array, each of the 103,000 klystrons will generate noise. The noise from each klystron will be noncoherent with the others. Reference 1 cites the use of phase control between klystrons to suppress near-in noise and multiple-cavity klystrons to suppress other noise. The adequacy of these controls for all noise emissions may require further development. Concern for the level of noncoherent noise suppression of the total array noise is of vital importance because the total array pattern will not be realized for this noncoherent noise. The beam pattern will be much broader, on the order of one degree, as found by the elements fed by one klystron in a power module. The power density of the noise in this broad, de-focused, array pattern will be reduced by the level of the noise in a klystron to that of the carrier. This broad radiation pattern would cover a radius about the rectenna of approximately 500 km. This characteristic of large phased arrays has been noted in military systems. Figure 1 illustrates a measured antenna pattern of a large phased array fed by 32 cross-field amplifiers. The broad antenna pattern formed by the array for the noncoherent noise is clearly illustrated.

¹Concept Development and Evaluation Program: Satellite Power System, DOE/ER-0023, January 1979.

Measurement data on noise emissions from early SPS prototype development is required to ensure control of noncoherent noise.

The EMC between SPS and military C-E equipments points to the establishment of proper specifications and standards to ensure control/quality of future compatible systems. EMC issues are expected to arise that will require technical and managerial attention. EMC issues are design dependent; however, some operational constraints will be required in military C-E equipment usage even with optimal design of the SPS. It is recommended that the SPS program initiate an EMC characteristics life test verification program. Life testing of active transmitting components should be started early in the program.

TABLE 1
C-E SYSTEM TYPES AND DEGRADATION

<u>C-E System Type</u>	<u>Degradation Criteria</u>	<u>Interference Thresholds</u>
Analog Voice Communications	Articulation Score and/ or Index	Interference power that reduces AI below 0.7
Telemetry	Bit Error Rate (BER) or Signal-to-Interference Ratios (S/I)	Increased BER or reduce S/I below ≈ 14 dB*
TACAN	Valid Reply Rate	Average interference power (~ -27 dBm)
IFF	Valid Reply Rate	Average interference power (~ -0 dBm)
Search Radar	Desensitization and False Alarms	Radar receiver (~ 6 dB below noise level) or S/I = 12 dB
Track Radar	RMS tracking error	Average power dependent (~ 6 dB below noise)
ILS	Change in angular direction	Change in direction of $\pm 5\%$
Microwave Relay	Bit Error Rate (BER) or S/I	Increased BER; reduce S/I below ≈ 16 dB*
Monitoring Instrumentation	(one-of-a-kind equipment, occasionally very sensitive)	

*Required S/I dependent on particular telemetry or microwave relay and radar involved.

AZIMUTHAL ANTENNA PATTERNS SPURIOUS EMISSIONS

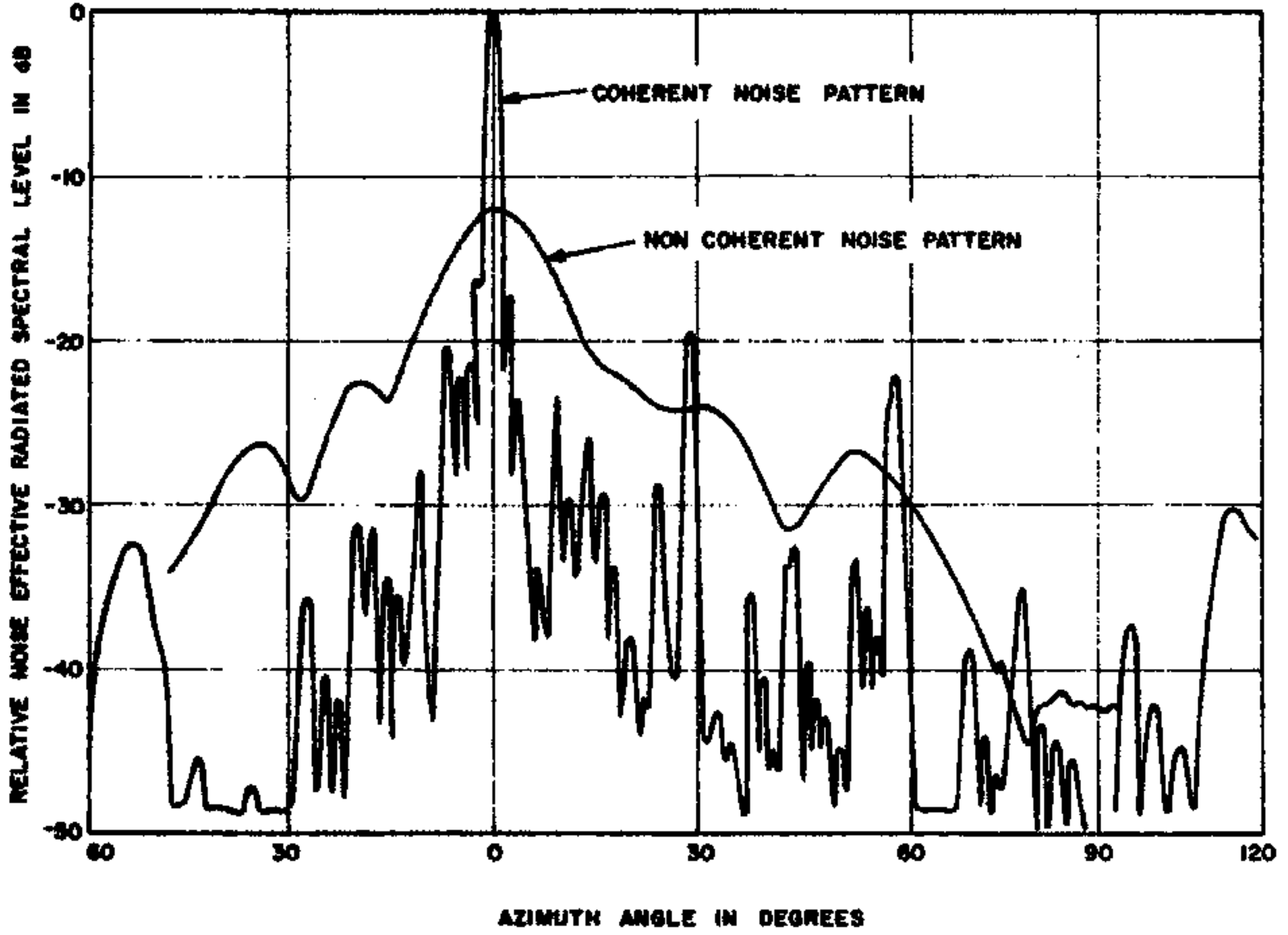

Figure 1.

ENCOUNTERS BETWEEN SPS POWER BEAMS AND SATELLITES IN LOWER ORBITS

Philip K. Chapman

Arthur D. Little, Inc., Cambridge, Massachusetts 02140

Each Solar Power Satellite (SPS) will preempt, not only a location in geosynchronous orbit (GEO), but a large region of space (of order several hundred thousand cubic kilometers) for its power beam. If the SPS is geostationary, the beam is fixed relative to the Earth and thus rotates like the spoke of a wheel with the diurnal rotation. Other satellites in lower orbits (including those in transit to GEO) may pass through the beam, causing RFI with satellite systems or perhaps damage to sensors. In some cases, it may be necessary briefly to shut down a given SPS as a satellite approaches its power beam.

If the inclinations of the orbits of both the SPS and a lower satellite are exactly zero, and if the SPS is feeding a rectenna directly on the equator, then the satellite will clearly encounter the power beam on every revolution. In the general case, in which the rectenna is at a higher latitude L and the orbit of the lower satellite has a finite inclination i , the frequency of encounters is much less.

As the power beam rotates with the Earth, it generates a conic surface about the polar axis. The intersection of this surface with an inclined orbital plane is a conic section; because of the large apex angle of the cone, the intersection will be an hyperbola except for nearly equatorial satellites. The locus of the beam intersection in the satellite plane starts at GEO altitude when the SPS passes through the right ascension of the ascending node, sweeps down to a minimum altitude (which depends on L and i) and then back up to GEO at the descending node, taking twelve hours. There is no intersection with the satellite orbital plane during the next twelve hours, until the SPS reaches the ascending node again. Since the satellite orbit, in general, has two intersections with the beam locus, there are usually only two opportunities per day for encounters between a given satellite and a given beam. Whether or not an encounter occurs naturally depends on the orbital position of the satellite at the times when these opportunities occur.

The shape and orientation of the intersection locus are fixed when the latitude of the rectenna and the inclination and orientation of the lower orbital plane are given, so that beams from several SPS's, feeding rectennas at the same latitude, will follow identical paths in a given orbital plane. The longitude of the rectenna and SPS determines only the time of day when the encounter opportunities occur.

The duration of the encounter of a small satellite with the beam can be up to two seconds, with large satellites taking somewhat longer -- for example, if a new SPS is completely assembled in low Earth orbit (LEO) and then transported to GEO, its encounter with the beam of an existing SPS could take 3 to 4 seconds. If it is necessary to shut down the beam to avoid the encounter, or if it is occulted by a large vehicle, the duration of the outage will thus be brief.

For $i < L$, there is a maximum safe altitude, below which a satellite will not encounter the beam: for example, a satellite launched due east from Cape Kennedy will not encounter the beam to a rectenna at latitude 35° unless its altitude is greater than 1000 km. The situation is shown in Fig. 1, in which the plane of the figure is the satellite orbital plane, and the locus of the beam intersection is depicted.

For satellites above the safe altitude, an estimate of the probability of an encounter may be obtained by assuming the orbital phase is randomly distributed -- as might be the case, for example, if the satellites were launched at random times, without coordination with the SPS. It is found that the chance of an encounter reaches a maximum just above the safe altitude, then drops off quite rapidly. It is possible for a satellite in an orbit of altitude 1200 km and inclination 28.5° to have about one chance in 2000 of an encounter with the beam to a given temperate-zone rectenna, during its first day of operation. Once an encounter has occurred (or the orbital position has been otherwise determined), predicting future encounters is a deterministic problem, apart from stochastic orbit perturbations. It may be possible to choose the orbit altitude and phase so that encounters with a given beam occur very rarely, if at all.

The problem becomes more complex if multiple satellites and/or multiple SPS installations are considered. On average, it appears that, if large numbers of satellites (c.100) are in orbits of moderate altitude (500 to 5000km) and moderate inclination, one of them will pass through the beam to a given temperate-zone rectenna about once a month. Conversely, if there are large numbers (c.100) of randomly-scattered rectennas, a typical low satellite might expect to meet one of their power beams about once a month.

Because of the decrease in encounter probability with altitude, there does not at present appear to be any serious risk of encounters with power beams by a vehicle in low-thrust transfer from LEO to GEO.

Measures which might be taken to reduce the frequency or minimize the effects of beam/satellite encounters include the following:

- i. Rectennas could be prohibited within 2° of the equator, in order to avoid frequent beam encounters by equatorial satellites.
- ii. Rectennas could be built at as high latitudes as economically and geographically possible, in order to minimize interference with low satellites in orbits of moderate inclination.
- iii. Where mission objectives and launch penalties permit, the use of the lowest possible inclination for sensitive satellites could be encouraged.
- iv. Satellites could often be designed to withstand passage through the microwave beam (where, at higher altitudes, the flux density may be several hundred mW/cm^2), although it could be argued that the extra costs thus incurred should be borne by SPS operators.
- v. The power beam could be designed for rapid on-off switching or defocus (in times of a second or two), to minimize outages if it must be shut down to avoid damage to an approaching satellite. Continuous power to the utility grid could be ensured by modest energy-storage capacity at the rectenna, which may well be available to compensate for other, considerably longer outages.

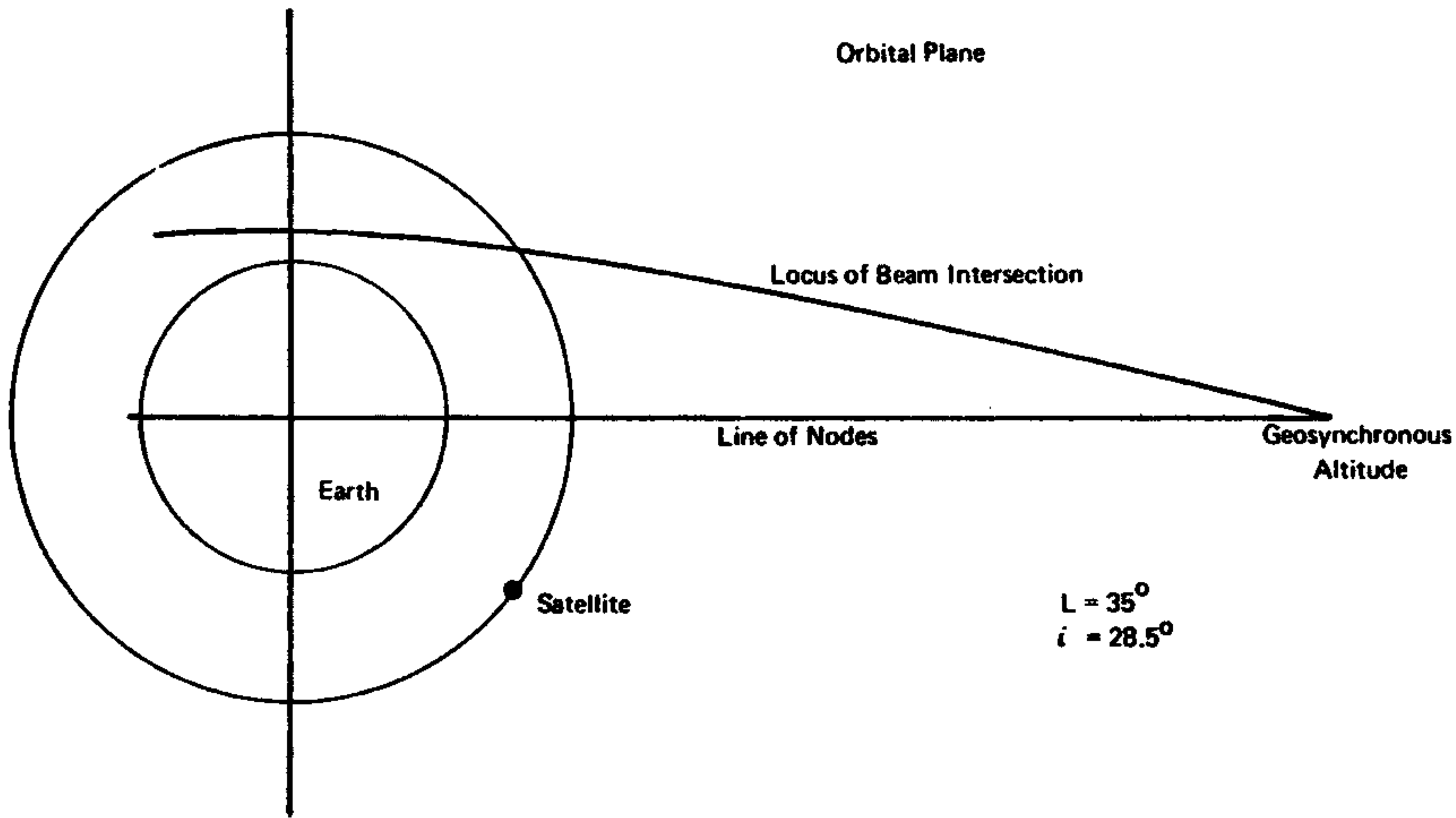

430

Approximately to Scale

FIGURE I LOCUS OF BEAM INTERSECTION WITH ORBITAL PLANE OF LOWER SATELLITE

THE EMC IMPACT OF SPS OPERATIONS ON LOW EARTH ORBIT SATELLITES

W. B. Grant and E. L. Morrison, Jr.

Institute for Telecommunication Sciences

K. C. Davis

Battelle Memorial Institute - Northwest Laboratories

Low orbiting (LEO) satellites have a significant probability of passing through an SPS main beam or principal sidelobes. This probability, and consequently the frequency of traversal, depends on the number of SPS stations in operation.

Operational effects for LEO satellites depend on orbits, equipment complement and usage modes, and vehicle physical configuration. Existing and planned LEO systems include remote sensing, navigation and position fixing, and communications functions. Sensors include electro-optical devices, active and passive microwave systems, and particle detectors.

The susceptibility of various operational and planned LEO satellites have been examined during the course of the SPS EMC evaluation program. Functional degradation for the electronic systems on LANDSAT, GPS, and the Space telescope is described in relation to the amplitude of the SPS illumination components. Analyses and tests include the modes of coupling to devices and subsystems, and performance effects in relation to satellite mission.

The SPS energy coupling into LANDSAT subsystems is indicated in Figure 1. As diagrammed, the communications, sensor, power bus, and attitude control functions can be effected. Coupling would occur through the communications antennas, attitude sensor optical apertures and the optical apertures and thermal louvers of the multispectral scanner (MSS) and thematic mapper (TM). Energy coupling through the solar panels to the power units, which would transmit noise to the on-board computers and instrumentation, is not a problem because of circuit filtering and regulation presently designed into the systems. Exposed area and scanner locations on the satellite indicate that the optical aperture is the principal SPS energy coupling mode for these sensors.

Figure 2 shows the SPS microwave beam geometry at LANDSAT orbit altitude of 704 km. From this field intensity estimation coupling energies can be calculated. From tests and analysis it was determined that at SPS main beam energy levels an increase in video channel noise of 8 percent was present in the TM/MSS instrumentation, and a decrease in modulation transfer function of 18 to 20 percent was induced which affects the spatial imaging capability by approximately 20%. These data are still being analyzed to determine the complete effects. For the direct earth-station to satellite S-band link, a bit error rate (BER) increase of 70 to 85 percent would occur during a period of about 16 seconds while the satellite was exposed to the SPS main beam and principal sidelobes. For the wide band communication channel used to transfer information via the tracking and data relay satellite system (TDRSS) the BER would increase by 20 to 40 percent during a pass through the power beam.

Mitigation techniques to be investigated include rejection filters and antenna modifications. For the TM and MSS, mitigation techniques to be confirmed include circuit filters, noise extraction in the data analysis process, and extended shielding for the detectors and colocated video amplifiers. Additional shielding for the video channel and scan control circuitry is recommended to eliminate jitter in the line scans, if the coupling is proven to be directly into these circuits and not through internal common connections.

The Global Positioning System has a satellite NAVSTAR at an orbit altitude of 10,900 miles. The SPS beam geometry at NAVSTAR orbit altitude is shown in Figure 3. The power coupling modes are diagrammed in Figure 4. Coupling to sensors and communications is similar to the LANDSAT. There can be direct coupling through the thermal control louvers that control the temperature of the principal electronic functions; clock, computer, and command/control receiver and decoder components. Induced jitter in the internal clock and message decoder logic is estimated to be in the 10 percent to 65 percent range for SPS power coupling of 10 watts to 25 watts. The S-band communication receiver and associated processor would experience an increase in BER in the range of 50 to 1,000 times with the antennas exposed to SPS power densities to 10 mw/cm^2 to 100 mw/cm^2 . The mitigation techniques would be very similar to LANDSAT.

The space telescope is in circular orbit some 312 miles in altitude. Communications with earth are via TDRSS. The telescope is a Cassegrain configuration and other on-board instrumentation under study are: wide field/planetary camera, faint object spectrograph, faint object camera, high resolution spectrograph, and high speed photometer/polarimeter. Figure 5 shows degradation in resolution for a 512 element array, charge coupled device (CCD) similar to one of the imaging devices on board space telescope. SPS effects and mitigation techniques for all system on board are under study.

Effects through the sun sensors for satellites in general are insignificant; approximately 2 percent increase in noise, primarily because of SPS harmonics would be present. This noise would cause less than 2° to 5° orientation change of the solar panels over a period of 1 to 1.3 seconds of maximum SPS beam exposure, and be corrected within 2 to 5 seconds after the satellite departs the SPS beam.

Figure 6 shows attitude error versus time for a star tracker sensor system used for satellite attitude stabilization. The lower curve shows the normal response as the system settles in with no outside influence. The upper curve shows the attitude error in arc-seconds where a satellite is in a stable position and the star tracker illuminated with a 15 mw/cm^2 , 2.6 GHz microwave signal. Since the satellite will be in the beam only short time, there may be between 3 to 8 arc-seconds of error introduced during a passage through the SPS beam, but as the lower curve shows this will settle out in 5 to 8 seconds after leaving the beam.

The analysis of data from the above satellites will be extrapolated into guidelines for future satellites indicating the character of degradation expected for proposed electronic elements. This will include specifications regarding the physical configuration and testing procedures pointing toward satisfactory performance of future satellites operating in an SPS environment.

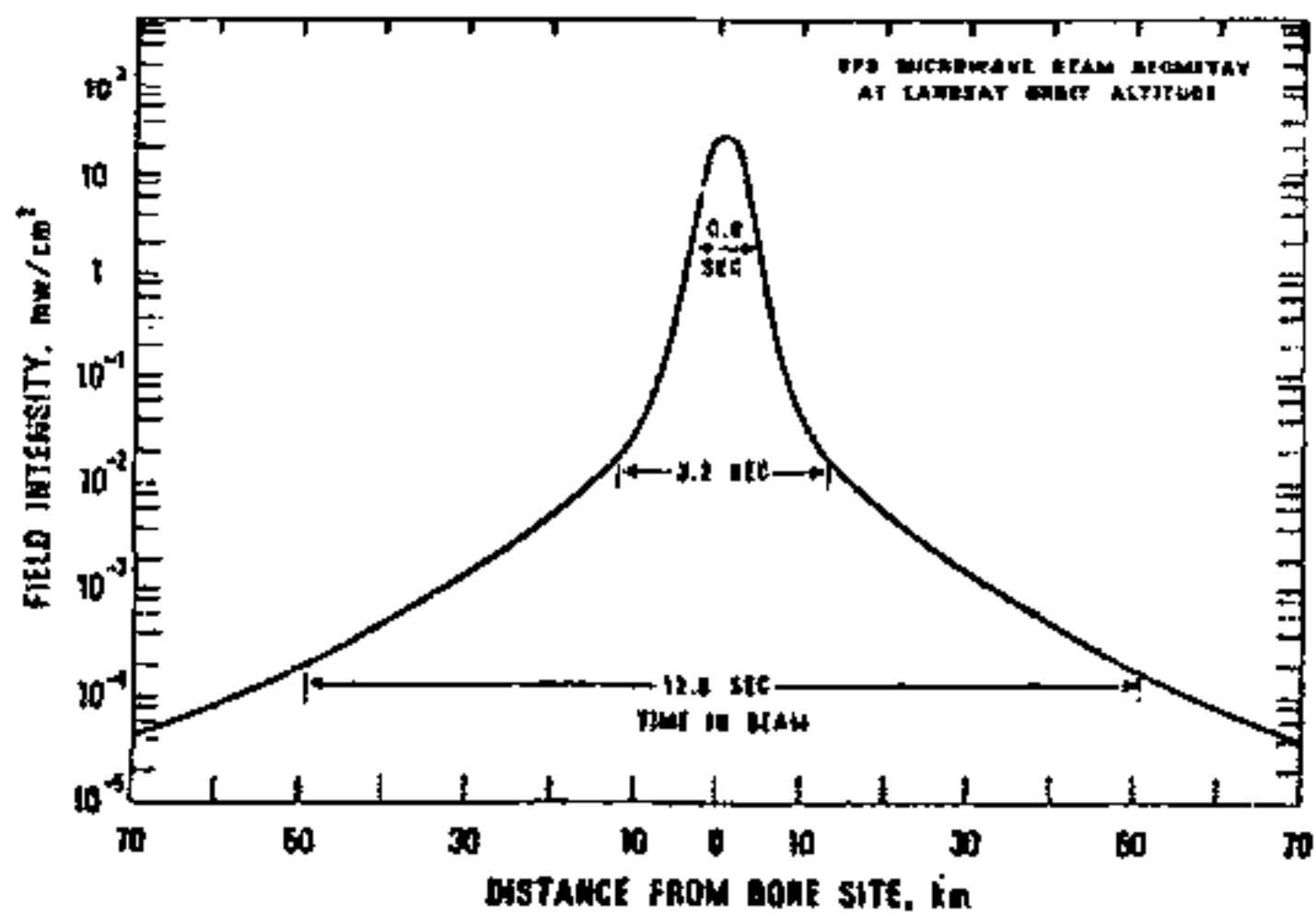

Figure 1

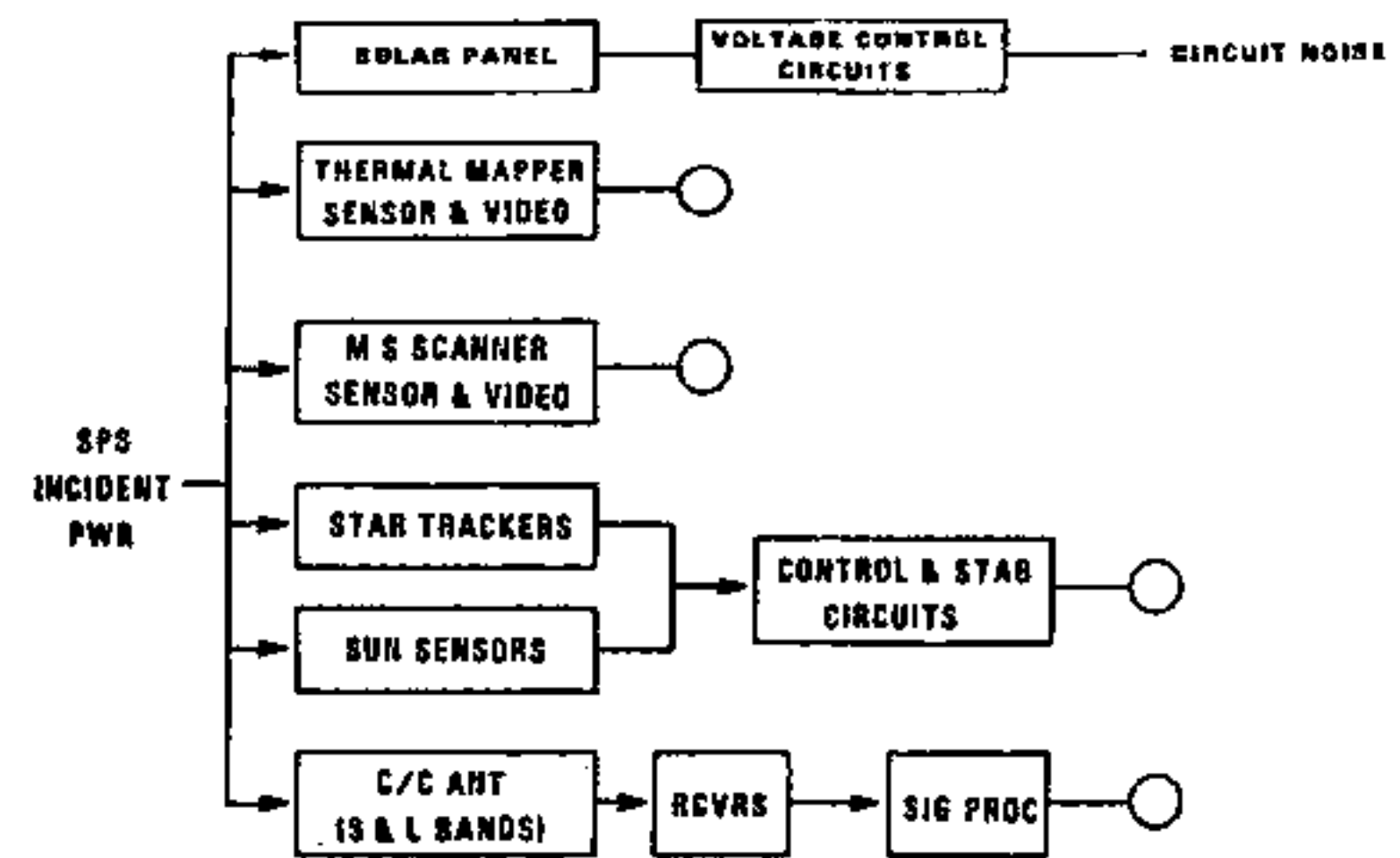
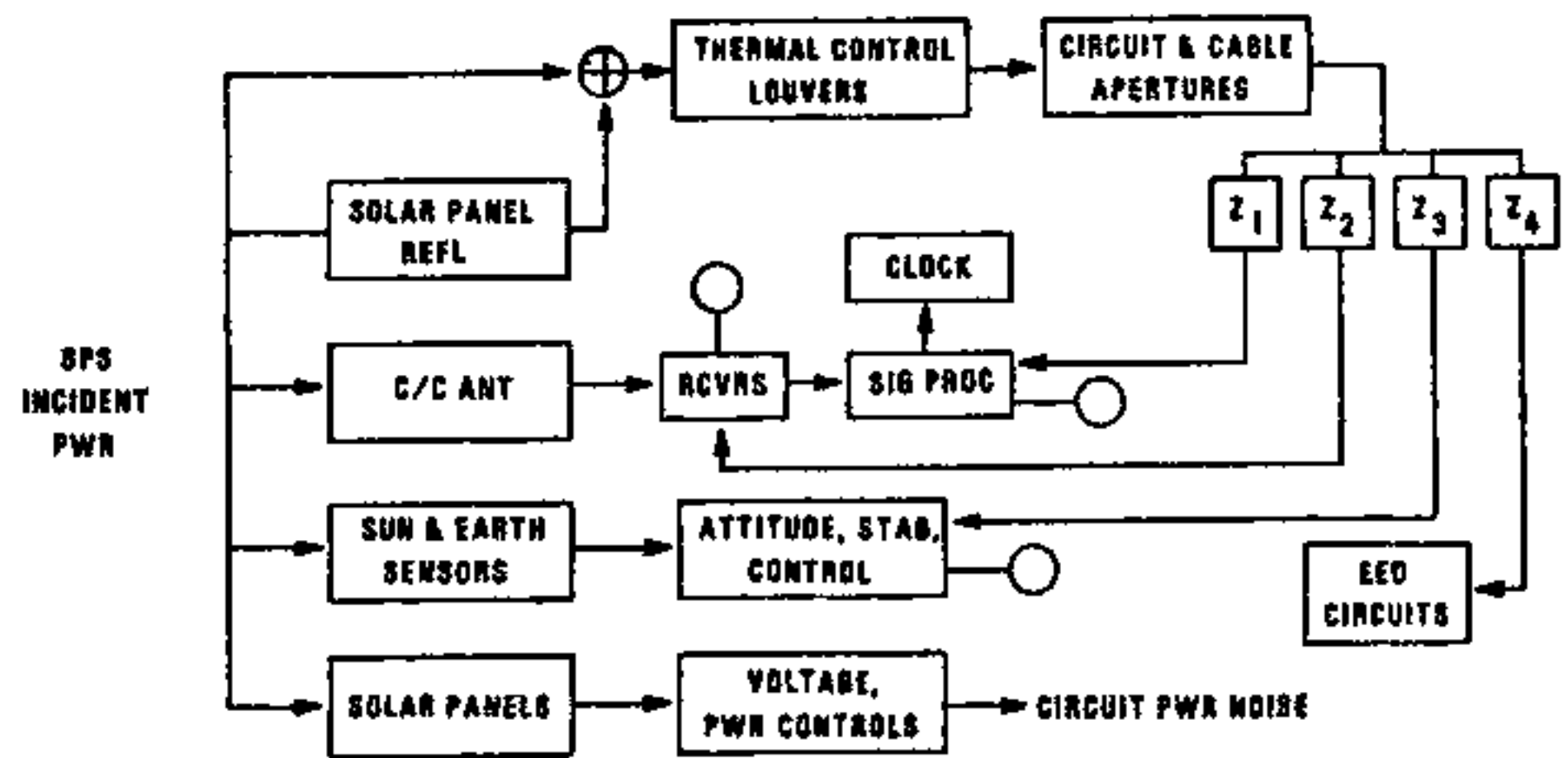

Figure 2

LANDSAT FUNCTIONAL IMPACT MODES



GPS FUNCTIONAL IMPACT MODES

Figure 4

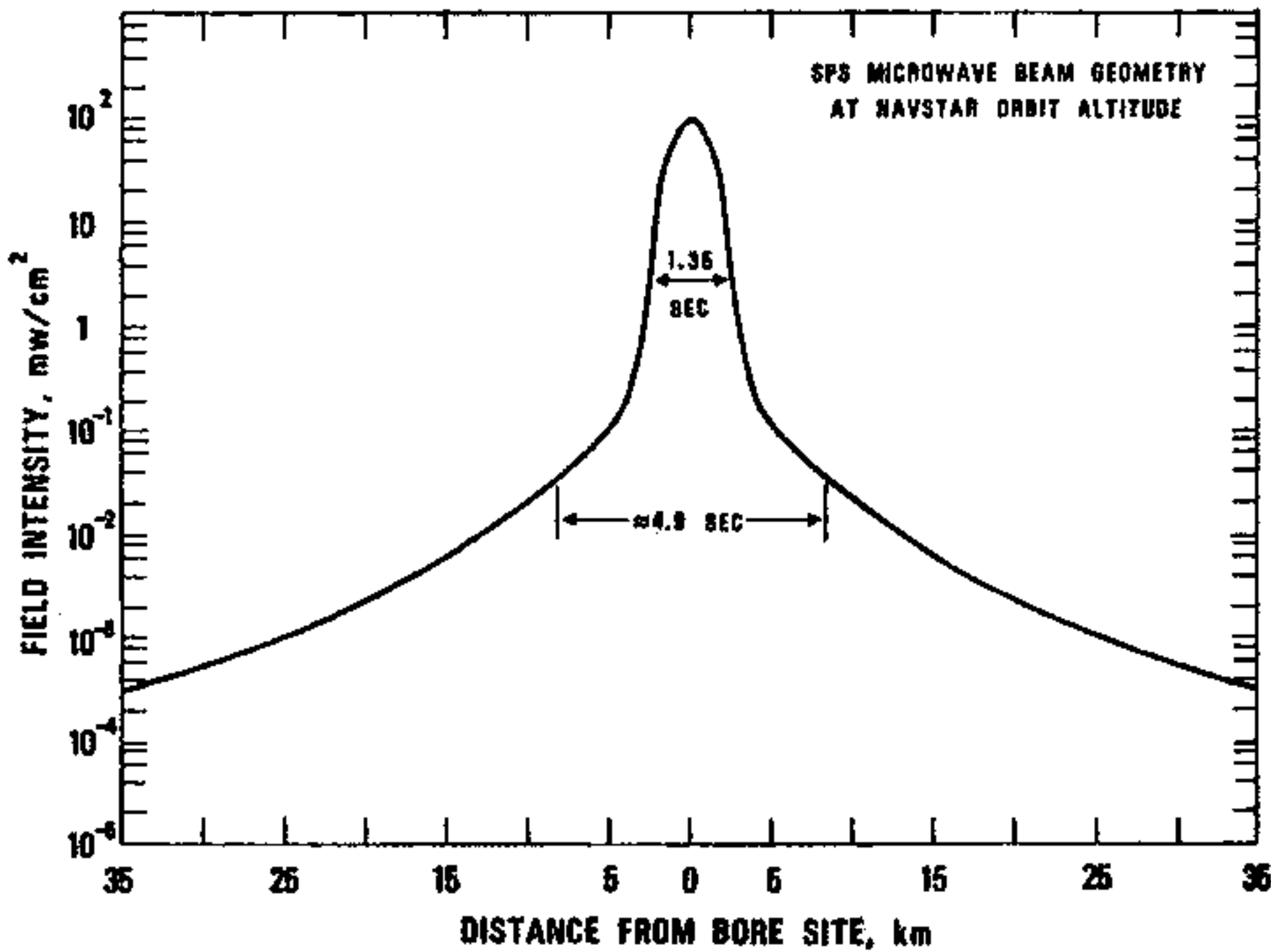

Figure 3

THE SPS INTERFERENCE PROBLEM -
ELECTRONIC SYSTEM EFFECTS AND MITIGATION TECHNIQUES

John R. Juroshek

U. S. Department of Commerce/NTIA
325 Broadway - Boulder, Colorado 80303

The potential for interference between SPS and various electronic systems is examined in this talk. The talk begins by briefly reviewing some of the causes of interference and their cures. Next estimates are presented of the various interference levels that can be expected from SPS. A significant portion of the remainder of the talk is then devoted to describing interference problems and protection requirements for satellite systems. The talk concludes by describing interference problems to other electronic devices such as integrated circuits.

One of the problems encountered during the analysis was the lack of estimates on the magnitude of the SPS microwave field at frequencies other than the fundamental. The characteristics of the transmission system at harmonics and frequency bands adjacent to the ISM band are currently unknown. For the analysis we have assumed out of band radiation levels as shown in figure 1 and 2. These values are representative of current technology. The interference levels are shown for both 4 kHz and 1 MHz reference bandwidths. The narrower bandwidths are of interest in interference studies with narrow band communications systems such as single channel per carrier satellite systems. The 1 MHz reference bandwidth is applicable to wideband systems such as the digital, pcm, multiple access systems.

The conclusions of the study are that interference is likely in the 2500 MHz to 2690 MHz direct broadcast satellite band adjacent to SPS. Estimates of the adjacent channel noise from SPS in this band are as high as -124 dBc/4 kHz and -100 dBc/MHz, where dBc represents decibels relative to the total power in the fundamental. A second potential problem is the 7350 MHz, 3d harmonic from SPS that falls within the 7300 MHz to 7450 MHz space-to-earth, government, satellite assignment. The talk will also discuss the separations required between SPS and other satellites in geosynchronous orbit.

A second example of the EMC study is the potential reaction of integrated circuits to microwave fields. Catastrophic failures can be produced in integrated circuits when the microwave power levels coupled into inputs and power leads reach 1 to 100 watts. The failures are typically due to bonding wire melting, metallization failures, and junction shorting. Non destructive interaction or interference, however, generally occurs with coupled power levels of the order of 10 milliwatts. This interaction is due to the rectification of microwave energy by the numerous pn junctions within these circuits. Table 3 shows estimates of the susceptibility of 3 representative integrated circuits in an SPS microwave field. Values in the table represent the difference between the maximum power coupled into the device and the interference threshold. Thus a positive number denotes a potential interference problem while a negative number indicates no interference. The table was prepared for worst case conditions of no shielding around the integrated circuit and a worst case alignment of the circuit and connecting leads in the microwave field.

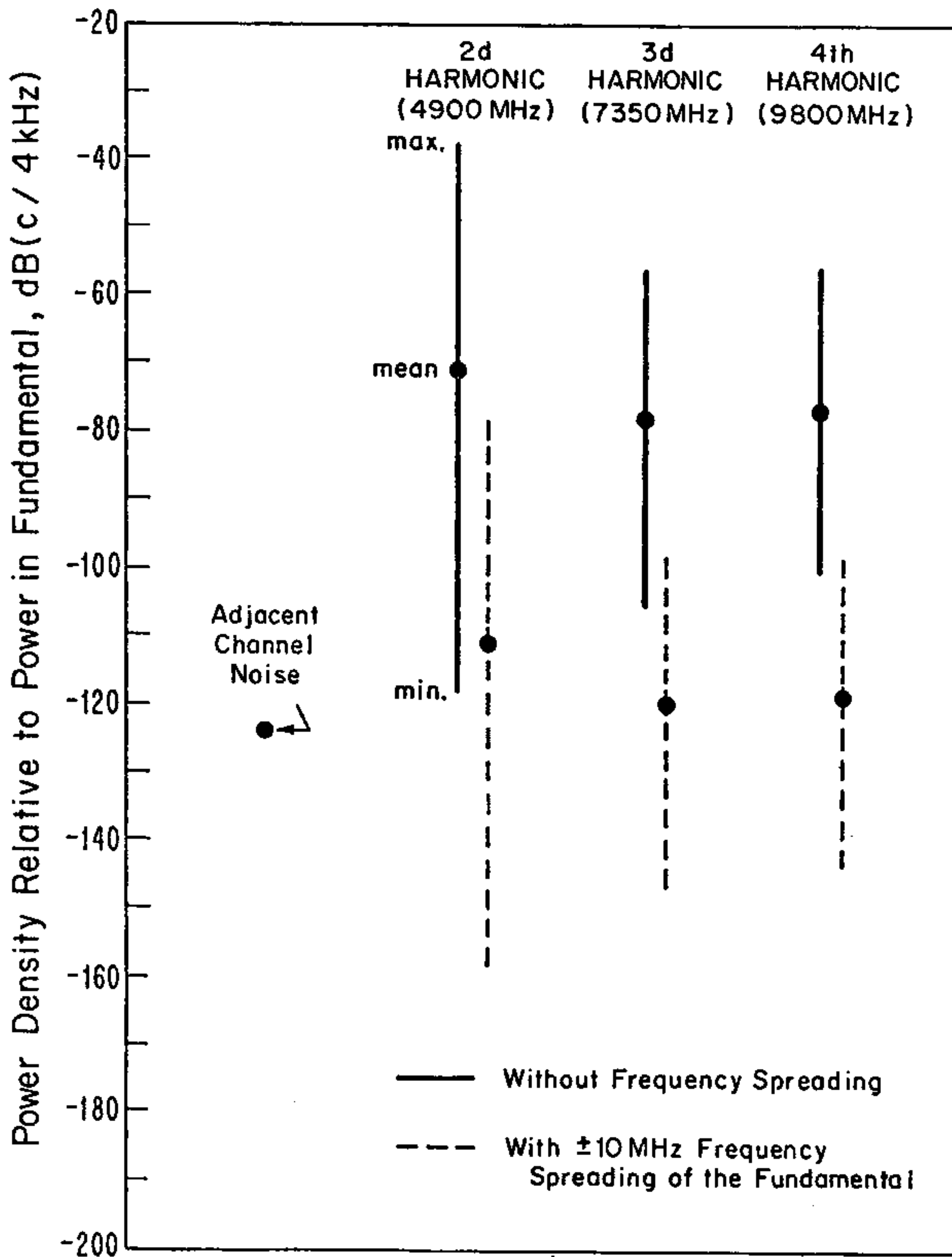

Figure 1. Estimates of interference levels in a 4 kHz bandwidth.

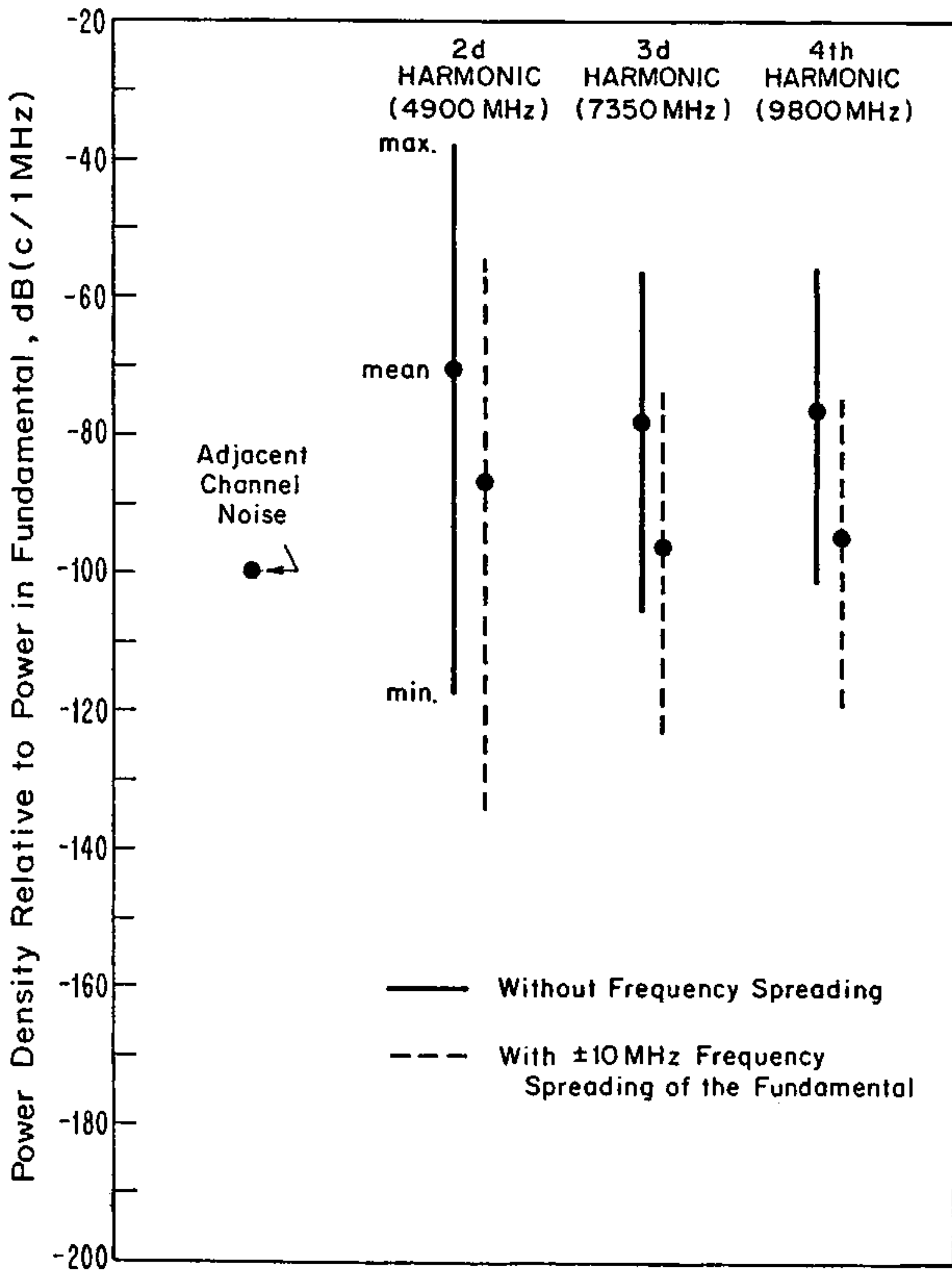

Figure 2. Estimates of interference levels in a 1 MHz bandwidth.

TABLE 3.

Difference between the maximum power coupled into three types of integrated circuits and interference threshold.

<u>LOCATION</u>	<u>7400 NAND GATE</u>	<u>4011 NAND GATE</u>	<u>5474 FLIP FLOP</u>
Center of Rectenna	+ 15.0 dB	+ 18.2 dB	+ 15.3 dB
Edge of Rectenna 5 km from Center	+ 1.3	+ 4.5	+ 1.6
Exclusion Fence 5.7 km from Center	-8.7	-5.4	-8.4
First Sidelobe 9.0 km from Center	- 9.6	-6.4	-9.3
Second Sidelobe 13.0 km from Center	-13.9	-10.7	-13.6
Third Sidelobe 17.0 km from Center	-18.6	-15.4	-18.3

ATMOSPHERIC EFFECTS OVERVIEW
D. M. Rote, Energy & Environmental Systems Division
Argonne National Laboratory, Argonne, IL 60439

The presentation consists of an overview of the Atmospheric Effects Assessment Program. The main source of disturbance is described as the space transportation system, which would include both liquid-fueled and electric ion rocket propelled vehicles. To transport the necessary materials into space, heavy lift launch vehicles approximately five times the size of the Saturn V would have to be launched once or twice per day for thirty years. The unprecedented scale of rocket activity will effect, at least to some degree, all levels of the atmosphere. In addition, while not as significant as those of the space transportation system, the impacts of the rectennas' structure and operation are also an issue of concern. Starting with the troposphere, where air quality impacts and inadvertent weather modification are major issues, the potential atmospheric effects and our present understanding of them are summarized as a function of altitude. It has been found that as the altitude increases, the increasingly rarified nature of the atmosphere lends itself to increasing possible degrees of modification but at the same time, our state of knowledge and our ability to predict the nature of those modifications and their consequences for man's environment decreases. Hence, at the furthest reaches of the atmosphere, namely in the plasmasphere and magnetosphere, where the orbit transfer vehicles will operate, virtually no experimental data as yet exists to support or reject the theoretical predictions of the potential impacts of injecting quantities of mass and energy large compared to that naturally present.

RECTENNA-RELATED ATMOSPHERIC EFFECTS

J. Lee, Energy and Environmental Systems Division
Argonne National Laboratory, Argonne, IL 60439

1. INTRODUCTION

The primary interest in the assessment of possible environmental effects arising from the existence and operations of the satellite power system (SPS) rectifying antennas (rectennas) is meteorological in nature. The presence of a rectenna covering an area of approximately 100 km² would be expected to alter the aerodynamic characteristics of the surface in its immediate vicinity. A change in surface roughness affects the vertical fluxes of momentum and thermal energy, and a change in radiative properties (albedo and emissivity) affects the surface energy budget. The operation of a rectenna would add an additional heat source at the surface. The consequences of these changes would be expected to alter the wind velocity profile and stability of the planetary boundary layer and hence to alter the local cloud population.

The possible influence of microwave transmission through the troposphere would be due to the absorption, especially in clouds, of microwave energy along the beam path, causing local heating. On the other hand, the presence of convective or turbulent air motions and the existence of hydrometers cause refraction, scattering, and absorption of microwave and can lead to beam wandering and spreading. The scope of this discussion is limited to the effect of SPS on tropospheric atmosphere. Many issues of concern regarding the effects of atmospheric conditions on SPS beam propagation can be found in the proceedings of a workshop held in August, 1978,¹ and will not be discussed here.

2. PREVIOUS STUDIES

A preliminary assessment based upon the maximum microwave-beam power density of 230 W/m² and an average waste heat release rate of 7.5 W/m² from a rectenna covering approximately 100 km² was conducted in 1977 by the Johnson Space Center.² The findings were that the effects of an SPS rectenna on weather and climate would be small compared to the direct environmental consequences of construction, and that the rectenna's influence would be similar to that of an average suburban development. Microwave heating of the lower atmosphere through gaseous absorption would be negligible. Any actual effects of microwave heating inside a cloud would not be detected in the presence of the natural variance of cloud and storm phenomena. Scattering by particles, even in heavily-polluted atmosphere, would also be negligible.

3. CONSENSUS OF AUGUST 1978 WORKSHOP¹

The above study was reviewed at the August 1978 workshop and the conclusions were updated. Three main topics were discussed: the effects of waste-heat release on the atmosphere at the rectenna site; microwave interactions with the atmosphere; and the possible effects of the microwave beam on atmospheric electrification processes. The following brief summary highlights the most important issues.

a. Rectenna Waste Heat and Structure. Construction of a rectenna would modify the thermal and radiative properties of the ground on which it is built; operations would introduce a heat source at the surface. Although the magnitude of the perturbation of the average surface heat budget would be on the order of

10%, microwave beam wandering and spreading due to atmospheric refraction may occasionally give rise to larger effects.

It is possible to investigate the effects of the rectenna by studying the effects of land-use changes. Small temperature changes (of the order of 1°C) can be expected under light wind conditions. Changes in cloud populations can also be expected. Somewhat larger man-made dissipation rates over comparable areas have been associated with apparent anomalies in the distribution of rainfall.

In hilly terrain, on scales smaller than the rectenna dimensions, diurnally varying changes occur in the surface energy budget that are larger than the projected rectenna waste heat. It is therefore expected that the meteorological effects of a rectenna would vary from site to site, and the central maximum heat dissipation (approximately 16 W/m²) might become important in augmenting a naturally occurring topographic effect.

Assessment of possible weather and climate effects over areas larger than the mesoscale should not be confined to the influence of the rectenna alone -- it is necessary to consider the whole satellite power system in the context of the energy demand it is designed to meet. The overriding feature of the system is that the major inefficiency, the rejection of waste heat, is in space. Furthermore, there are no significant emissions of material into the troposphere during operation.

b. Microwave Propagation. The atmospheric absorption of microwave energy at the proposed SPS frequency is negligible in clear air for the projected tropospheric path lengths of about 20 km. However, some absorption by condensed water (clouds and precipitation) would occur when storms entered the beam path.

c. Atmospheric Electricity. Direct interactions with the atmospheric electric fields are not thought to be important at the proposed frequency. However, the mere physical presence of the rectenna might have some modifying influence on the occurrence and electrical behavior of thunderstorms over and around the rectenna.

4. MODEL CALCULATIONS

In order to examine further the rectenna effects on local meteorological variables, a trial simulation using a three-dimensional, turbulence-closure model³ was made for a daytime, planetary-boundary-layer condition (constant potential temperature up to 650 m in height, then increasing with height at a rate of 3.5°C/km) with logarithmic wind profile up to 4 m/s and remaining constant above that. It was found that the increased roughness over the rectenna would considerably increase the surface heat flux (by a factor of 3.5) and friction velocity (by a factor of 1.9) at the center of the site in comparison with values located at the upstream boundary. The numerical values given in the parentheses are valid for the case of dry convection and little temperature contrast between the rectenna and the surrounding surface. Inclusion of 8 W/m² of waste heat would cause a surface temperature perturbation of less than 0.1°C.

A more realistic simulation was performed for a potentially unstable boundary layer with light winds over moist, flat ground.⁴ Such a situation is conducive to the natural formation of cumulus clouds without precipitation. The simulation indicated that, excluding the effects of albedo changes, the major cause of the perturbation is again the change in surface roughness rather than the release of waste heat. Air and soil temperature decreased during the daytime and increased only marginally at night. The increased mechanical mixing resulted in increased evaporation and absolute humidity, increased cloud amount, and decreased cloud-base height. The decrease in solar radiation resulting from the increase in cloud amount is greater than the waste heat term. Cloud modification would be expected to be quite different if the roughness had not been changed. The results found in this case (moist convection) are considerably different from those in the dry convection case above. A preliminary analysis of the problem of rectenna albedo and its diurnal variation indicated that differences between the rectenna albedo and that of the surrounding surface may be most significant factor.⁴ These effects need to be quantified in future work.

Information regarding the amount of microwave absorption per unit path length as a function of rainfall rate is available.⁵ With the most extreme rainfall rate of 254mm/hr as an example, the attenuation at the proposed 2.45-GHz frequency is estimated to be about 0.063 dB/km. At the proposed maximum power density of 230 W/m², the absorbed microwave power inside the storm would be approximately 3.2×10^{-3} W/m³, which is approximately two orders of magnitude smaller than the release rate of the buoyant energy of a typical cumulus cloud. It is reasonable to conclude that the absorption of SPS microwave power by a storm will have no significant influence on cloud dynamics and thermodynamics and the associated precipitation.

5. CONCLUSIONS

Analyses and model simulations in some chosen site situations and meteorological conditions indicate that the meteorological effects of the construction and operation of a rectenna are small, particularly outside the boundary of the structure. From weather and climate points of view, installation of an SPS rectenna seems likely to have effects comparable with those due to other nonindustrial land-use changes covering the same area. The absorption and scattering of microwave radiation in the troposphere would have negligible atmospheric effects.

It seems clear that rectenna-related meteorological effects are not a critical factor in the overall environment impact of the SPS. However, there are some remaining areas of detail that should be investigated; they are concerned with the radiative properties of the rectenna structure, the possible "triggering" of convective instability under certain meteorological conditions, and the nature of the terrain at and near the structure.

6. REFERENCES

1. Lee, J., organizer, "Proceedings of the Workshop on Meteorological Effects of Satellite Power System Rectenna Operation and Related Microwave Transmission Problems," CONF-7808114, Office of Energy Research, U.S. Dept. of Energy, Washington, DC 20545, Dec. 1979.
2. Allen, N.C., "Preliminary Study of Possible Weather Effects Due to Solar Power Satellite Rectenna Operation," Internal Note No. JSC-12519, Johnson Space Center, National Aeronautics and Space Administration, Houston, TX, 1977.
3. Yamada, T., "A Three-dimensional, Second-order Closure Numerical Model of Mesoscale Circulation in the Lower Atmosphere," Argonne National Laboratory, Report No. ANL/RER-78-1, 1978.
4. Robinson, G.D., The Center for the Environment and Man, Inc., unpublished information, Jan. 1980.
5. Skolnik, M.I., ed., "Radar Handbook," McGraw-Hill Book Co., New York, NY, 24-1 to 24-40, 1970.

GROUND CLOUD AIR QUALITY EFFECTS

K. L. Brubaker
Argonne National Laboratory

The effects on air quality of the launching of a large rocket such as the HLLV are all expected to be restricted to the vicinity of the launch site, and are all associated with the development and subsequent evolution of the ground cloud. No detectable air quality effects are expected from the thin column of exhaust generated as the rocket rises rapidly through the troposphere.

The ground cloud consists of the exhaust emitted by the rocket during the first 15-25 seconds following ignition and liftoff, together with a large quantity of entrained air, cooling water, dust and other debris.

Immediately after formation, the ground cloud rises in the air due to the buoyant effect of its high thermal energy content. Eventually, at an altitude typically between 0.7 and 3 km, the cloud stabilizes and is carried along by the prevailing wind at that altitude. As the cloud rises, much of the surface dust and debris falls out, the distance over which the fallout occurs being determined by the wind speed, by the nature of the turbulence within the cloud, and by the size of the particles. This distance may be as great as a few kilometers.

The ground cloud represents a source of air pollution and associated effects. The cloud disperses over a period of time, the rate of dispersion being determined by the level of turbulence both in the cloud itself and in the ambient atmosphere. Depending on the ambient conditions, adverse environmental effects may be produced at ground level. Due to the use of liquid methane as fuel, any air quality effects must arise from substances present in relatively small amounts. The major exhaust products of the HLLV booster will be carbon dioxide and water. No effects are expected from these substances. Smaller quantities of nitrogen oxides, primarily nitric oxide and nitrogen dioxide, are expected to be produced from a possible molecular nitrogen impurity in the fuel or liquid oxygen, or from entrainment and heating of ambient air in the hot rocket exhaust. In addition, possible impurities such as sulfur in the fuel would give rise to a corresponding amount of oxidation products such as sulfur dioxide.

The only substances which are potentially significant from an air quality point of view are the nitrogen oxides; any sulfur dioxide will be present at so low a level as to be unimportant, based upon actual measurements on an Atlas/Centaur ground cloud. It is estimated that an HLLV ground cloud will contain approximately 1.0×10^4 kg of nitrogen dioxide (NO_2) and 8.5×10^3 kg of nitric oxide (NO), with the peak cloud concentrations estimated at 0.50 and 0.64 ppmV, respectively. By way of comparison, the total peak NO_x ($\text{NO} + \text{NO}_2$) concentration of 1.14 ppmV is 3 to 4 times larger than NO_x concentrations measured in typical power plant plumes at distances on the order of 1 km from the stack.

Two different effects arising from the presence of nitrogen oxides in the ground cloud must be considered. The first is an enhanced ground-level concentration of NO_2 for a period of up to a few hours following a launch. It is likely that within a year or two, a one-hour national ambient air quality standard for NO_2 of about 0.25 ppmV will be promulgated. The state of California already has such a standard. Modeling studies indicate that in meteorological

logical conditions typical of the Cape Kennedy area, ground-level NO_2 concentrations in the vicinity of the cloud on the order of 0.10 ppmV may be produced following a launch. Thus, the launch by itself is unlikely to cause a violation of a 0.25 ppmV standard, but may be sufficient to cause a violation if ambient concentrations are already close to the standard. Under more adverse meteorological conditions, the contribution of the ground cloud may be even higher and further work is required to adequately investigate this possibility.

Figure 1 shows the results of one calculation of the NO_2 concentration at ground level as a function of time after launch and of the radial distance from the point just below the ground cloud center. The distance has been normalized by the standard deviation σ of the (horizontal) Gaussian distribution assumed for the ground cloud contribution to the NO_x concentration. The estimated initial value of σ was 2200 meters, and 3220 meters after one hour. The cloud stabilization height was 1300 m. Ambient concentrations were: ozone = 0.12 ppmV, NO_x = 0.25 ppmV (NO_2 = 0.23, NO = 0.02). Contour values are given in ppmV. A region in which the NO_2 concentration is greater than 0.25 ppmV clearly exists and persists for approximately two hours.

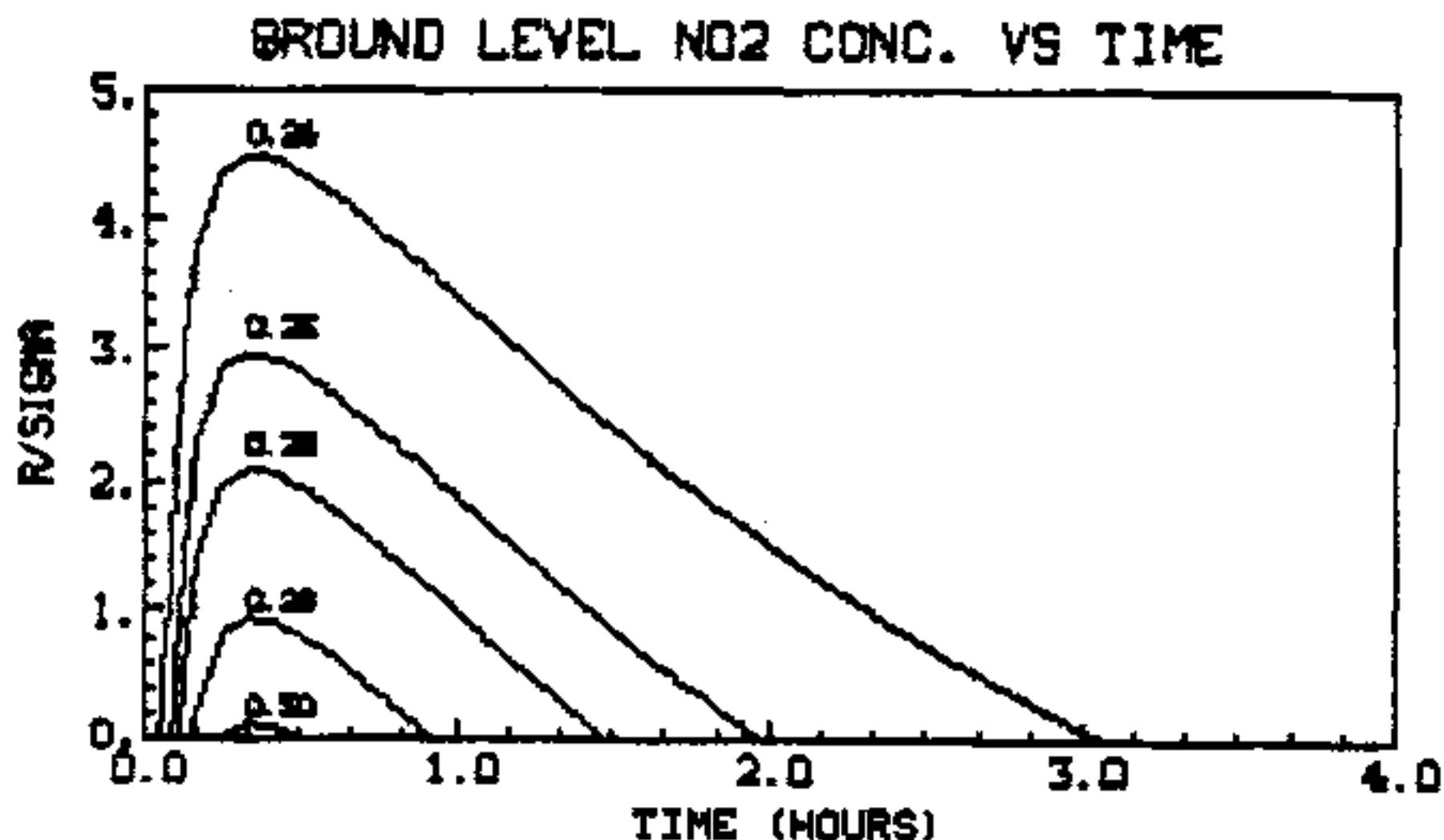

The second effect that must be considered is a possible enhancement of acid rain in the vicinity of the launch site. When dissolved in water, NO_2 forms a mixture of nitric and nitrous acids. Rainfall through the ground cloud (or rising from within) will therefore be more acidic than would otherwise be the case. By making the unphysical assumptions that dissolved NO_2 is instantly and completely converted to acid and ignoring the fact that cloud NO_2 will be depleted by the washout process, an estimate of the pH of rain (rainfall rate = 10 mm/hour) of 3.5 is obtained. This should be regarded as an unrealistically low value; a more realistic estimate would lie in the range 4.0 - 5.5. This is not considered excessively acidic, and no significant effects are expected especially when the highly localized and transient nature of the precipitation is taken into account.

1. INTRODUCTION

The proposed heavy lift launch vehicle (HLLV) would emit a large amount of thermal energy to the atmospheric boundary layer. The buoyancy resulting from this thermal energy release will raise the exhaust ground cloud to an altitude from several hundreds to several thousands meters, depending upon the ambient meteorological conditions. Meanwhile, the upward convective motion of the ground cloud and the surrounding air may result in the formation of a water-saturated cloud and associated precipitation. In addition, cloud microphysical processes may be affected by the production in the rocket exhaust of both cloud condensation nuclei (CCN) and ice-forming nuclei (IN).

The principal concerns about inadvertent weather modification by SPS rocket effluents are (1) the possibility that the ground cloud might temporarily modify local weather and (2) the cumulative effects of nearly 500 launches per year. We shall discuss these issues of concern through the consideration of (1) the possible alteration of the microphysical processes of clouds in the general area due to rocket effluents and debris and cooling water entrained during the launch and (2) the direct dynamical and thermodynamical responses to the inputs of thermal energy and moisture from the rocket exhaust for given ambient meteorological conditions.

2. MICROPHYSICAL ASPECTS

The central issue of these aspects is the possible production of cloud condensation nuclei and ice nuclei in the rocket exhaust ground cloud. Cloud condensation nuclei serve as particles upon which water vapor condenses to form water droplets that in turn form clouds and fogs. They play an important role in determining the colloidal stability of clouds and the formation of precipitation. In general, the addition of CCN may tend to slow down the warm rain-formation processes if the total CCN exceeds 10^3 cm^{-3} . However, if very large hygroscopic particles (giant nuclei with radii $>25\mu\text{m}$ like those expected to come from launch pad debris) are present, the rain-formation process may be accelerated. In the Florida area, some rainfalls are associated with condensation-freezing processes in a deep convection cloud system. In an IN-deficient, supercooled cloud, the addition of IN is expected to stimulate ice nucleation processes and lead to precipitation, although the effectiveness of this process by means of artificial cloud seeding remains controversial.

The recent measurements of Atlas/Centaur ground cloud¹ indicated that concentrations of CCN were meteorologically significant. The initial emission was approximately 1.2×10^{17} CCN (active at 0.5% supersaturation); later, CCN were produced in the ground cloud at a rate of approximately $1 \text{ CCN cm}^{-3}\text{s}^{-1}$. Field and laboratory measurements^{1,2} of a Tital III ground cloud indicated that both the IN and CCN concentrations were of meteorological significance. The initial emission of CCN from the Tital III was approximately 10^{18} (active at 0.5% supersaturation) and further CCN were produced at a rate of $0.5 - 1 \text{ CCN cm}^{-3}\text{s}^{-1}$ for a period of four hours after launch. The high concentration of cloud condensation nuclei observed in both solid- and liquid-fueled clouds could alter the frequency and persistence of fogs and haziness on the surface and the precipitation processes in warm clouds.

3. DYNAMICAL AND THERMODYNAMICAL ASPECTS

The proposed HLLV would emit approximately 1.08×10^{11} cal/s of thermal energy together with 2.02×10^7 g/s of water to the atmosphere. Approximately 15s of exhaust would be contained in the ground cloud. The thermal energy provides sufficient buoyancy to lift the ground cloud and surrounding air to higher altitudes. During the course of rising, air cools through adiabatic expansion and, under certain conditions, reaches saturation to form water-saturated cloud. Cloud convection is, then, further enhanced through release of latent heat, and, in some situations, it could lead to precipitation.

The phenomenon of a wet, saturated cloud formed by rocket exhaust has been observed on several occasions. Perhaps the most comprehensive and unique data are those obtained during a Tital III launch on December 13, 1978 at Kennedy Space Center. Temperature and dew point soundings prior to the time of launch indicate that air in the surface boundary layer is humid but potentially stable as shown in Fig. 1. Rocket effluents produced a saturated white cloud having the characteristics of a moderately-sized, vigorous cumulus cloud. Aircraft measurements taken 25 minutes after launch indicated that the ground cloud was still saturated with a liquid water content of about 0.1 g/m^3 . Thereafter, only portions of the ground cloud were found to be saturated; however, liquid water content was still detectable until 51 minutes after launch.

Model calculations indicated that, under the same meteorological condition, the HLLV thermal effluent could generate a much more vigorous convective cloud than a Titan effluent did as shown in Fig. 2. The maximum cloud liquid water content in the HLLV cloud was predicted to be about 3 times that of the Titan cloud as compared in Fig. 3 (where an initial thermal energy of 9.4×10^{10} cal was assumed in the Titan cloud). Furthermore, a light precipitation with a maximum rainwater of 0.07 g/kg was predicted for the HLLV cloud, but the duration of a saturated cloud was shorter. Virtually all the liquid water and precipitation are from the atmosphere, not from the content of the HLLV and Titan rocket exhaust.

The above relationships should not be used to scale predictions of HLLV effects. For example, under a potentially unstable condition with a deep surface boundary layer where the temperature lapse rate is adiabatic, quasi-steady-state convective clouds with similar intensities could be generated by all types of rockets in which the exhaust thermal energies are different by two orders of magnitude. The predicted precipitations are slightly different in intensity for different types of rockets.

In view of the nonlinearity and the relative insensitivity of the results to the rocket energy output in some situations, a climatology of the HLLV impacts should be conducted for a given launch site and for an updated HLLV reference information. Cloud modifications from SPS effluents are sensitively dependent upon the ambient meteorological conditions. Generally, the conditions that favor onshore flow without strong westerlies above the planetary boundary layer are conducive to greater inadvertent weather modification by SPS rocket launches in the Florida area. Characteristic synoptic weather regimes that would fall into this category were identified in a theoretical study of space-shuttle exhaust cloud.³

CONCLUSIONS

The huge amount of thermal energy contained in the exhaust of the proposed HLLV would in some situations induce a saturated, wet convective cloud or enhance an existing convective activity. The degree and duration of these effects depend upon the ambient meteorological conditions. Generally, the effects would be more pronounced in potentially unstable air, which is conducive to natural cloud formation. Nevertheless, the effects would be limited to the general area of the launch site. The observed long-lasting high concentrations of cloud condensation nuclei produced during and after a rocket launch may appreciably affect the frequency of occurrence and persistence of fogs and haze. In view of the high mission frequency proposed for the SPS vehicle launches, a potential exists for a cumulative effect. More studies are needed in this regard.

REFERENCES

1. Hindman, E.E. II, and L.F. Raabe, "Cloud Nuclei from Launches of Liquid and Solid Fueled Rockets," Extended Abstracts 7th Conference on Inadvertent and Planned Weather Modification, Oct. 8-12, 1979, American Meteor. Soc., pp. 18-19.
2. Parungo, F.P., and P.A. Allee, "Rocket Effluent - It's Ice Nucleation Activity and Related Properties," J. Appl. Meteor., 17, 1856-1863 (1978).
3. Bollay, E., et al., "Position Paper on the Potential of Inadvertent Weather Modification of the Florida Peninsula Resulting from Neutralization of Space Shuttle Solid Rocket Booster Exhaust Clouds," Institute on Man and Science, Rensselaerville, NY, NASA Contractor Report 3091, Nov. 1979.

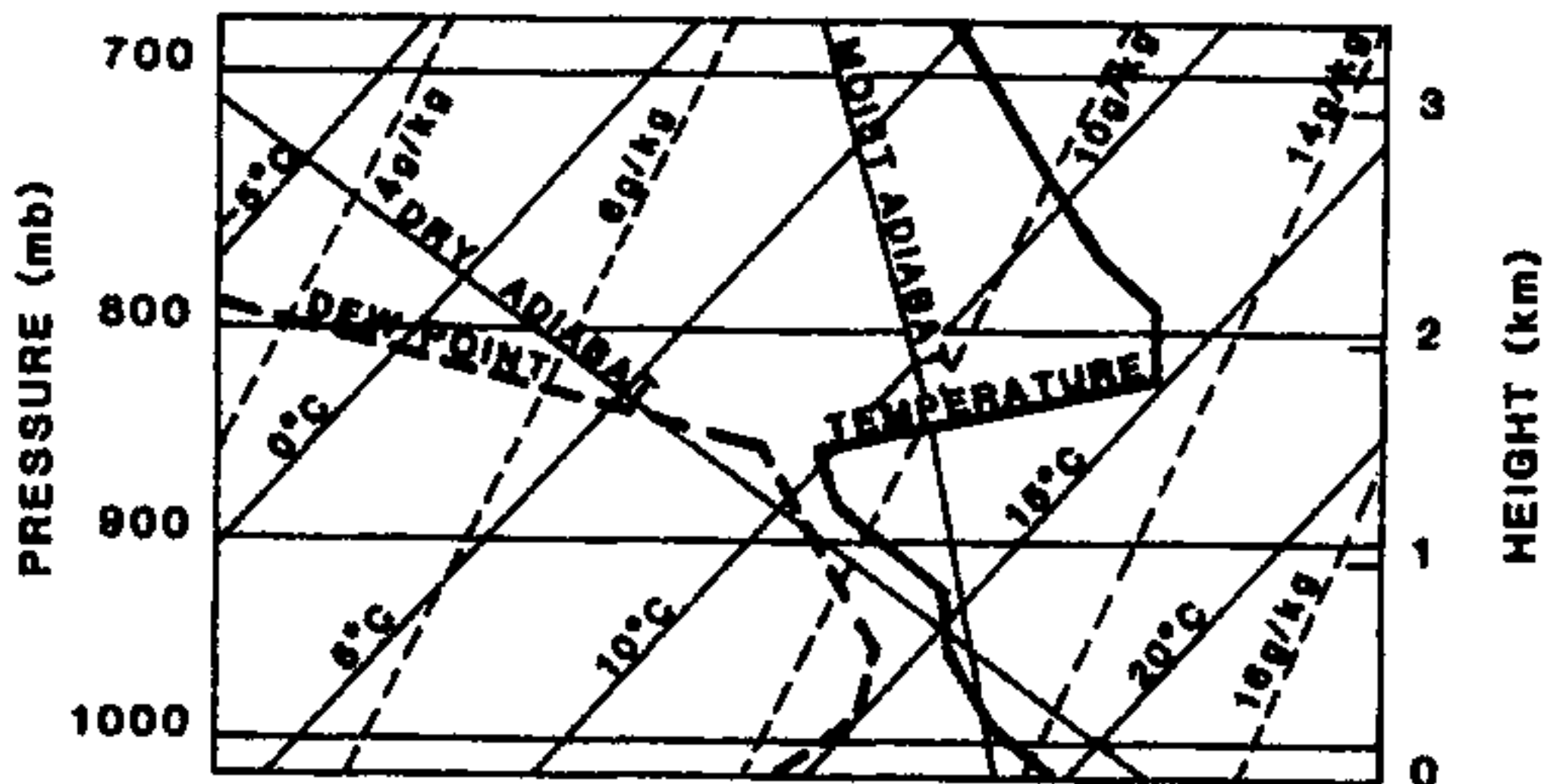

Fig. 1. Basic Sounding for 1936 EST 13 December 1978, CAPE CANAVERAL, Florida

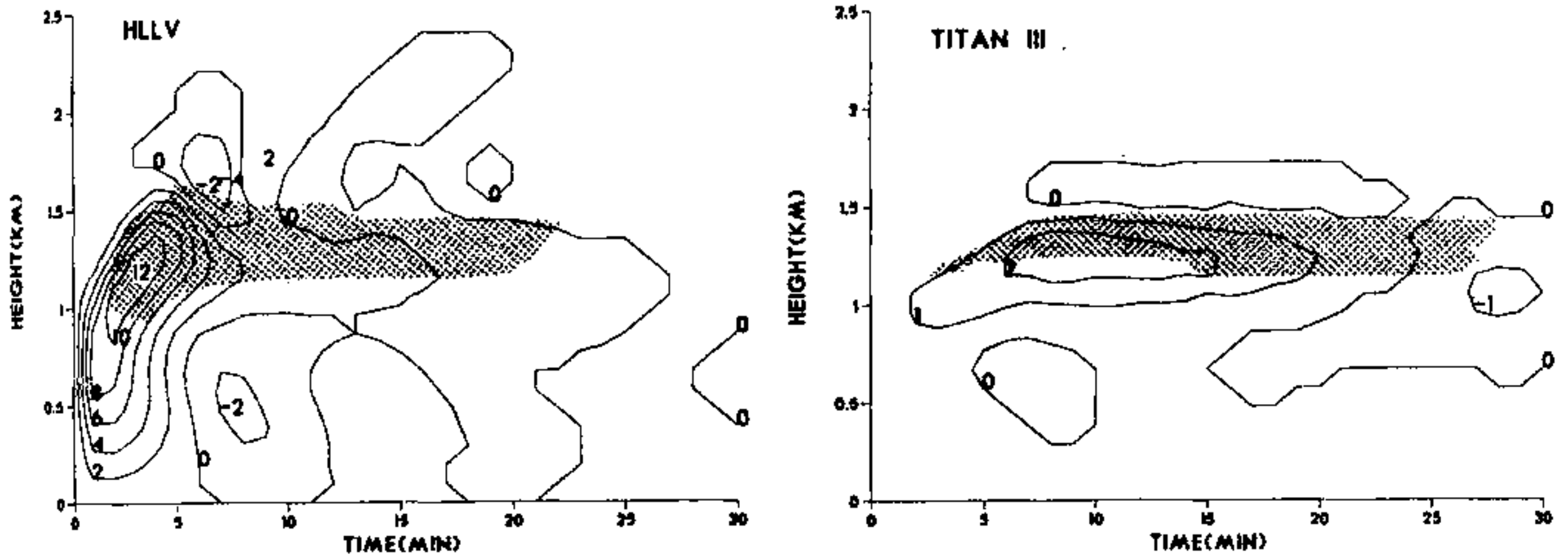

Fig. 2. Comparison of predicted maximum vertical velocity (m/s) between HLLV and Titan III ground clouds. Shaded areas indicate saturation regions.

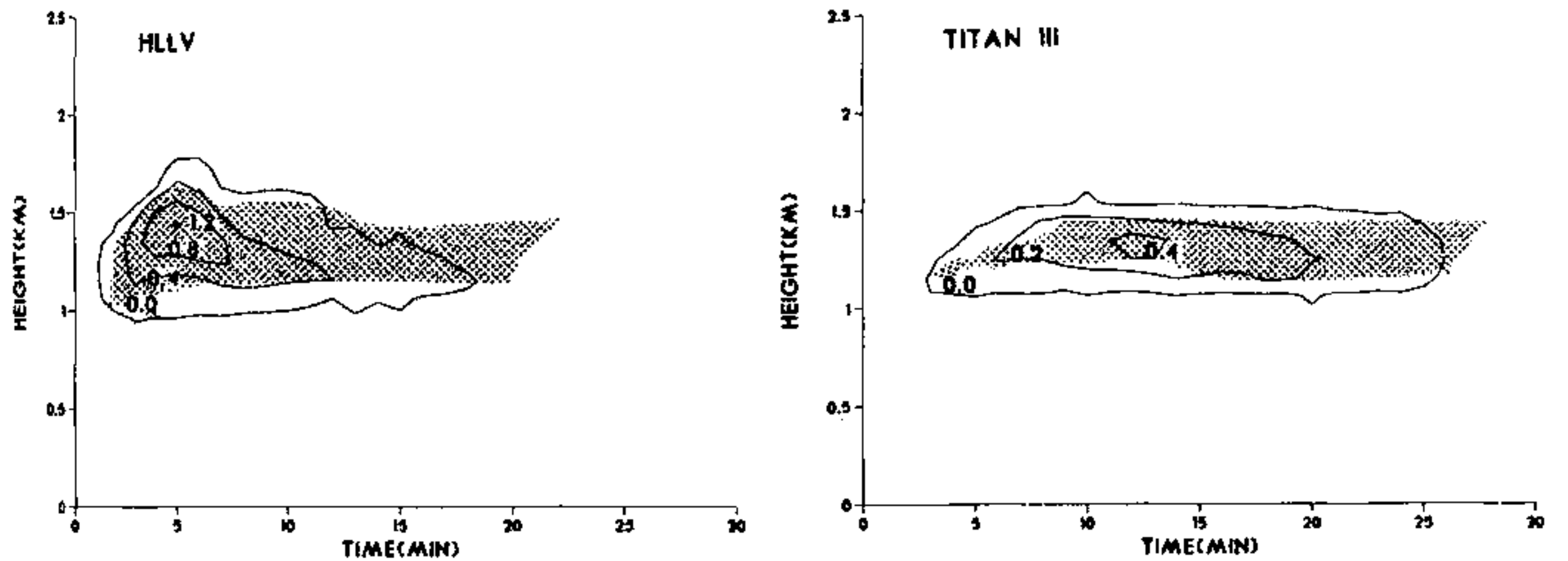

Fig. 3. Comparison of predicted mean cloud liquid water content (g/kg) between HLLV and Titan III clouds. Shaded areas indicate saturation regions.

OVERVIEW OF HLLV EFFLUENTS IN STRATOSPHERE AND ABOVE

K.L. Brubaker

Argonne National Laboratory

The single most important SPS-related cause of large-scale upper atmospheric effects is the injection of large quantities of rocket exhaust effluent into atmospheric regions in which the exhaust products are naturally present only in trace quantities. Of the four vehicles involved, the heavy lift launch vehicle (HLLV) is by far the most important source of exhaust effluent in the region between the Earth's surface and low-Earth orbit (LEO). This discussion provides an overview of HLLV emissions and the corresponding potential atmospheric effects.

The factors which make the HLLV so important are the unprecedented size (400 ton payload) and launch frequency (375 or more flights/year). In combination, these factors imply that an unprecedented quantity of exhaust products will be emitted. Due to the choice of fuels for the first and second stages, the main exhaust products below the staging altitude of 56 km are CO₂ and H₂O, and H₂O and H₂ above that altitude. In addition, there will be small amounts of CO, H₂ and NO deposited below 56 km and a significant amount of NO deposited during second-stage reentry between 60 and 90 km. Most of the second-stage exhaust emissions take place between 110 km and 125 km, because of the particular trajectory chosen.

Injections of exhaust effluent into the stratosphere by the first stage is not expected to have any detectable effects; the projected exhaust emissions give rise to concentration changes which are orders of magnitude smaller than existing levels even for "trace" substances like water and the nitrogen oxides.

Injections of water and molecular hydrogen by the HLLV second stage in the mesosphere and lower thermosphere may give rise to a variety of effects. Table 1 summarizes these emissions. It is expected that an artificial noctilucent cloud will be produced following each launch, and that such a cloud will persist for several hours at least, but probably not as long as a day. Upward diffusion of H₂O and H₂ and the downward motion of the exhaust cloud from the circularization burn are expected to cause some temporary depletion of the plasma density in the F-region of the ionosphere. Reentry-produced nitric oxide will persist within a more or less localized region for perhaps 1-2 days. In addition, global, long-term effects must be considered, especially in view of the high launch frequency. Theoretical calculations indicate that the global average water concentration at the mesopause will increase by about 1%, with an increase on the order of 15% near the launch latitude. The hemispheric average integrated ozone column density is expected to decrease by approximately 0.03%. No long-term accumulation of noctilucent clouds is expected. Figure 1 shows the result of a simple calculation of the steady-state global average increase in the water concentration as a function of altitude. The treatment of chemistry was considerably simplified and the figure should be considered as providing a rough estimate only and not necessarily as quantitatively correct. The effect of the reaction between water and oxygen ions at around 250 km can be clearly seen as a broad depression in the curve. These calculations yield water concentrations of 0.1 ppmV at 90 km, 8 ppmV at 120 km, 4 ppmV at 150 km and 0.5 ppmV at 200 km.

Figure 2 shows the result of a similar calculation for molecular hydrogen. Again, the effects of reaction with oxygen ions can be clearly seen.

Finally, based upon an injection rate of 2×10^{33} NO molecules/year due to reentry in the region from 60 to 90 km, an ambient loading of 4.7×10^{32} molecules and an approximate residence time of 4 days, the expected increase in the steady-state, globally averaged mesospheric NO concentrations is estimated to be 4%.

Table 1
HLLV INJECTIONS ABOVE 56 KM

Burn	Altitude (km)	Magnitude/flight (metric tons)	
		Water	Hydrogen
Main	56-125	2210	80
Circ.	477	20	0.7
Deorbit	477	11	0.4
Reentry	80-90	300 (NO)	

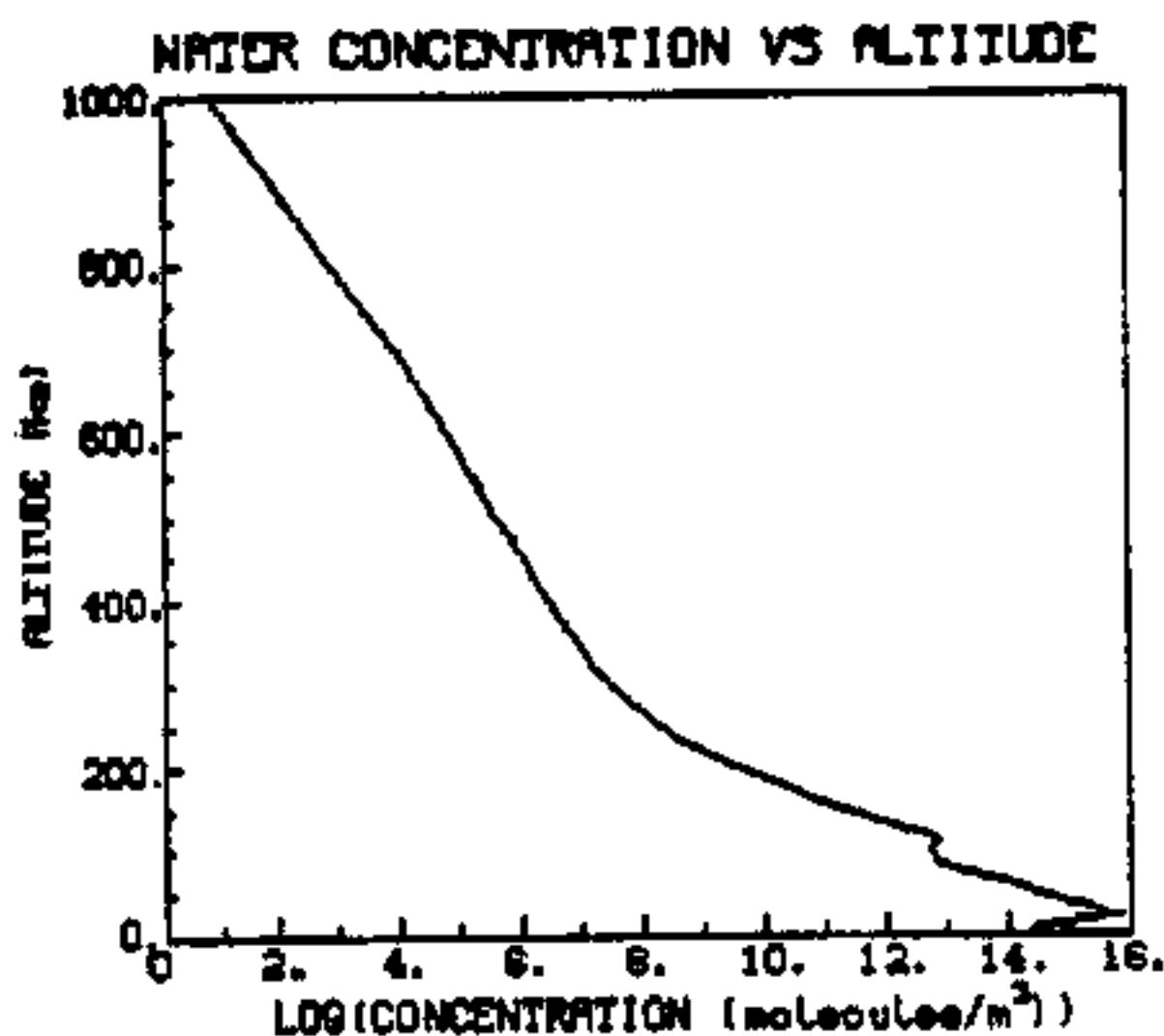

Figure 1

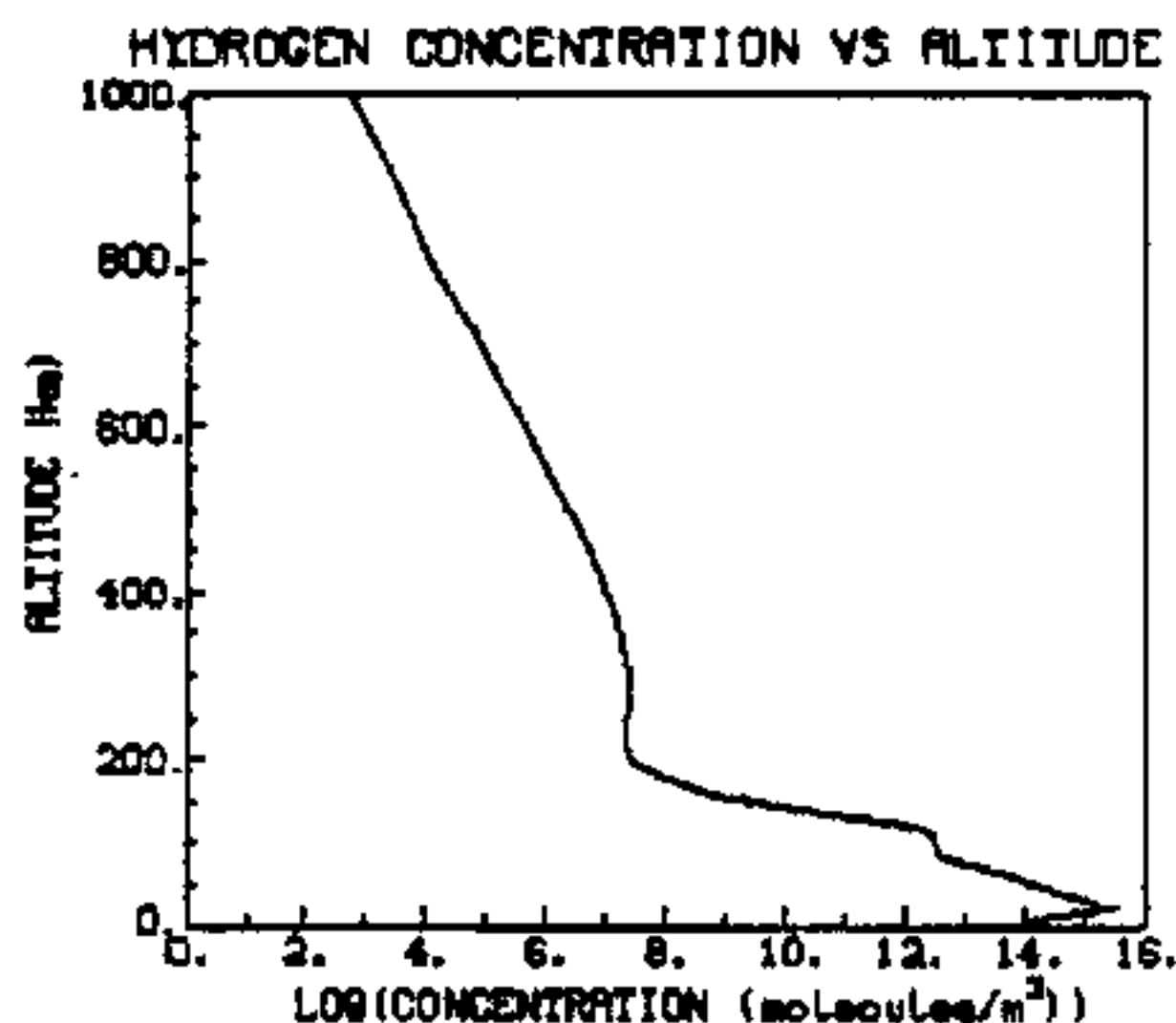

Figure 2

MESOSPHERIC CLOUD FORMATIONS

Jeffrey M. Forbes

Space Data Analysis Laboratory, Boston College, Chestnut Hill, MA 02167

The natural existence of noctilucent clouds at high latitudes during summer suggests that deposition of large amounts of H_2O by HLLV exhausts near the cold mesopause (85 Km) could result in the formation of mesospheric clouds. Studies of mesospheric cloud formation indicate that three conditions must be met in order to form and maintain clouds near the mesopause: (1) As discussed by Witt (1969), homogeneous nucleation is slow, and condensation nuclei are required for sufficiently fast growth of ice particles. (2) The ambient temperature must be less than the frost point temperature at which saturation occurs. (3) Sufficiently large vertical velocities might be required to ensure growth of ice to required dimensions ($\sim .1\mu$) for a given water vapor contents. Also, from the point of view of assessing SPS-related effects, the frequency and magnitude of H_2O injections are factors to be considered.

Witt (1969) points out that an effective source of condensation nuclei might be large water cluster ions, since the coulomb forces act to lower the free-energy barrier against the formation of small droplets, allowing particle growth to proceed relatively easily. In a companion paper (hereafter referred to as Paper I) in this volume entitled "D- and E-Region Effects" it is shown that injections of H_2O into the mesosphere resulting in volume mixing ratios greater than 100 ppmv could convert most of the O_2^+ and NO^+ ions at 85 Km to ions of the type $H^+(H_2O)_n$ ($n=1$ to 7), and thus provide an abundance of condensation nuclei. In Paper I it is estimated that H_2O mixing ratios greater than 100 ppmv can occur over areas of order $20,000 \text{ Km}^2$ for realistic SPS scenarios.

The terminal fall velocity at 85 Km of particles with density 1 g cm^{-3} and radius $.1\mu$ is about 1 msec^{-1} . Updrafts of this magnitude might be required to ensure growth of ice to required dimensions ($\sim .1\mu$) for a given water vapor content. Updrafts of 1 msec^{-1} are not thought to exist at midlatitudes, but only at high latitudes during summer. This is consistent with the observed seasonal and latitudinal occurrence of noctilucent clouds. However, it is shown by Reid (1975) that growth of needle-shaped or disc-shaped particles is much faster than growth of spherical particles, which could relax the requirement of vertical velocities of order 1 msec^{-1} .

Ice particles will grow (shrink) depending on whether the ambient temperature (T_a) is less (greater) than the frost point temperature (T_f) at which saturation occurs. In Figure 1, the latitude variation of mesopause temperature during summer and winter are plotted with frost point temperatures at 85 Km indicated for 1, 10, 10^2 , 10^3 , and 10^4 ppmv. During winter, there does not seem to be any possibility of maintaining clouds, even for mixing ratios as high as 10^4 ppmv. During summer, T_f exceeds T_a above 67 deg N for mixing ratios of order 10 ppmv. At midlatitudes (30-45 deg), where SPS launch activities would likely occur, mixing ratios of order 10^3 ppmv would be required for the maintenance of clouds at the mesopause. A crude estimate of possible effects has been obtained by calculating (see Paper I) the post-launch redistribution of H_2O due to diffusion, transport by winds, and photodissociation, and determining over what area T_f exceeds T_a . Assuming HLLV second stage deposits of 7.0×10^{31} molecules of H_2O evenly distributed over 70-120 Km, and injection frequencies ranging from 2 week^{-1} to 8 day^{-1} , T_f is exceeded over areas of order 200 Km^2 around the point of injection. This area estimate is probably correct to within an order of magnitude unless the scenarios examined

here are grossly in error with regard to frequency and magnitude of injected H₂O.

It is emphasized that a more definitive answer to the question of mesospheric cloud formation due to repeated depositions of H₂O by space launch vehicles would require much preliminary basic research into the processes and conditions involved in the transition from small nucleation particles to macroscopic cloud particles, and into the transport mechanisms and overall water vapor budget of the mesosphere.

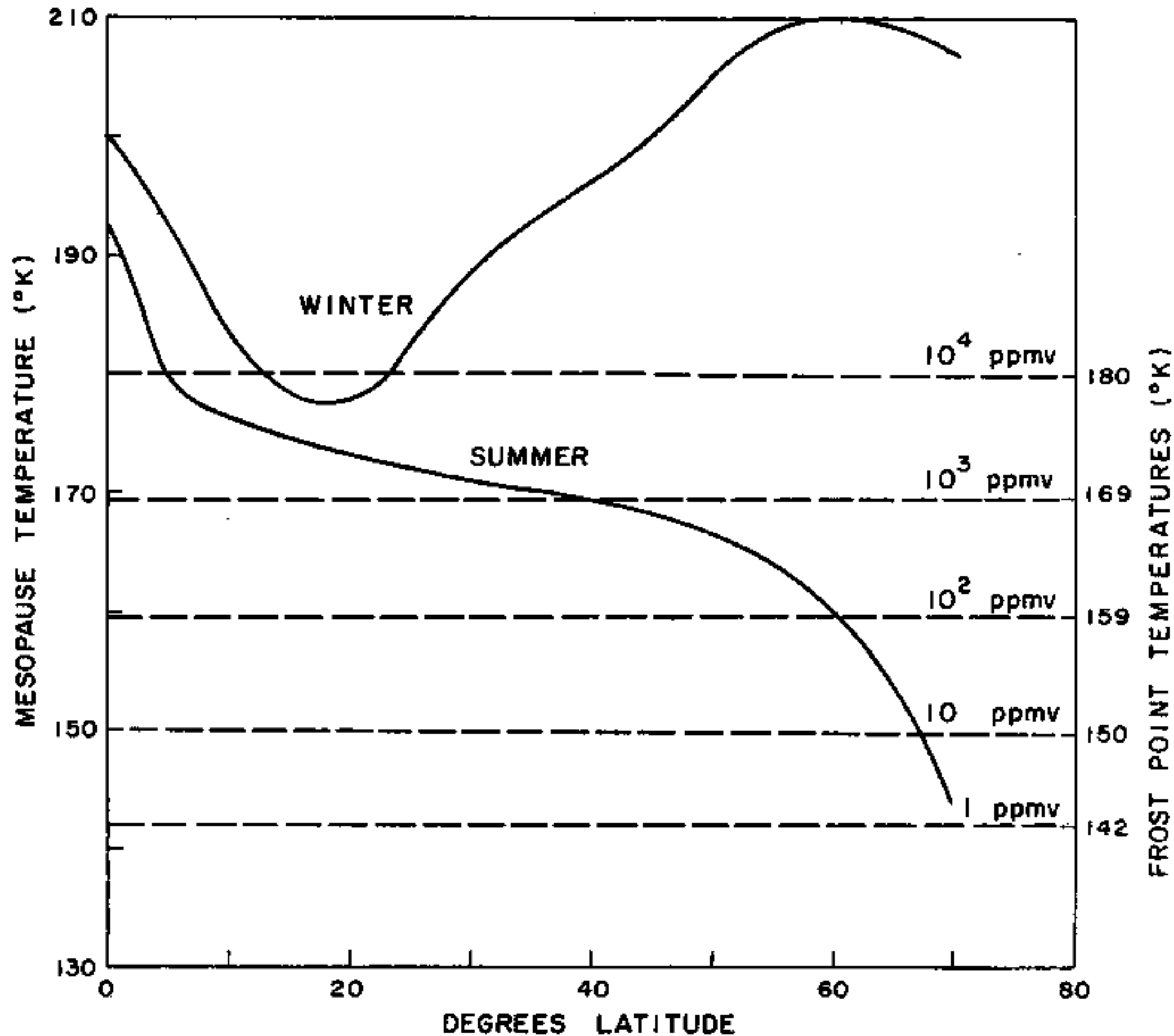

Figure 1. Mesopause temperature vs. latitude and frost-point temperatures for various H₂O volume mixing ratios at 85 Km.

REFERENCES

- Reid, G.C., "Ice Clouds at the Summer Polar Mesopause", *J. Atmos. Sci.*, 32, 523-535, 1975.
- Witt, G., "The Nature of Noctilucent Clouds", *Space Research IX*, Pergamon Press, Oxford, 157-169, 1969.

D- AND E-REGION EFFECTS

Jeffrey M. Forbes

Space Data Analysis Laboratory, Boston College, Chestnut Hill, MA 02167

A time-dependent analytic formalism is utilized to examine the competing effects of transport, photodissociation, and frequency of injection on the steady-state global distribution of HLLV second-stage discharges of H₂O, and to estimate concomitant effects on the ion chemistries of the D- and E-regions. For details of the following presentation, see Forbes (1980).

The model assumes the 70-120 Km height range to be a slab, or closed system; in other words, diffusion of H₂O to above 120 Km or below 70 Km is prohibited. This simplifying assumption can be crudely justified by noting the slow vertical diffusion velocity near 70 Km and the short photochemical half-life of H₂O compared to the diffusive residence time near 120 Km (see Forbes (1980)). In slab model the equation governing the height-integrated number density of H₂O is

$$\frac{\partial n}{\partial t} + \bar{u} \frac{\partial n}{\partial x} + \bar{v} \frac{\partial n}{\partial y} - K_h \frac{\partial^2 n}{\partial x^2} - K_h \frac{\partial^2 n}{\partial y^2} = C_o \delta(x) \delta(y) f(t) - Jn \quad (1)$$

where \bar{u} = an average E-W wind speed (30 deg long day⁻¹)

\bar{v} = an average N-S wind speed (.5 deg long day⁻¹)

x = E-W coordinate

y = N-S coordinate

t = time

K_h = horizontal eddy diffusivity (10¹⁰ cm² sec⁻¹)

J = rate of photolysis of H₂O (.5 day⁻¹)

$C_o = N_o / (z_2 - z_1)$

N_o = total number of H₂O molecules injected between 70 and 120 Km per launch (7.0 × 10³¹)

z_2 = 120 Km

z_1 = 70 Km

If the time history of the water discharges is represented by equally-spaced delta functions with period T, $f(t) = \sum_{n=0}^{\infty} \delta(t-nT)$, then the solution to (1) is

$$n(x,y,t) = \sum_{m=0}^M \frac{C_o U(t_m)}{4\pi Dt_m} \exp \left\{ - \left[\frac{(x - \bar{u}t_m)^2 + (y - \bar{v}t_m)^2}{4Dt_m} - Jt_m \right] \right\} \quad (2)$$

where $t_m = t - mT$, $M = t/T$, and $U(t - t_0)$ is the unit step function. This solution represents the superposition of M 3-dimensional Gaussian-shaped pulses moving away from the point of injection at $\bar{u} = 30$ deg long day⁻¹ and $\bar{v} = .5$ deg long day⁻¹, the width of the pulses increasing as \sqrt{t} due to diffusive expansion, and the peak amplitude decreasing as $t^{-1}e^{-Jt}$ due to diffusive expansion and photolysis of H₂O. Forbes (1980) describes how a water vapor volume mixing ratio (χ) representative of the 75-95 Km height region can be inferred from the height integrated number densities. Steady-state values of χ for $T = .125, .25, 1.0, \text{ and } 4.0$ days at 1 hr and 6 hr after injection are plotted vs. longitude in Figure 1, illustrating that only for $T \geq 1$ day do the pulses retain their longitudinal identity without diffusing into one another. This is because the 10% width of the pulses is $\sqrt{4 Dt \log_e 10}$ or $\sim 10 \sqrt{t}$ deg (where t is in days), whereas the peak-to-peak spacing is $\bar{u}T$ in longitude. As shown in Figure 2, the pulses do not retain their identity with respect to latitude since $10 \sqrt{t} \gg \bar{v}T$.

Note that χ is diminished to less than ambient values (~ 3 ppmv) long before being advected one circuit (360 deg) around the earth. The combined effects of advection by winds, the high mixing rates characteristic of the mesosphere and lower thermosphere, and the short photolytic lifetime of H₂O (~ 2 days), act to prevent significant global or even regional steady-state buildups of H₂O. As indicated by Forbes (1980), a baseline value for measurable environmental effects is $\chi = 100$ ppmv between 80 and 90 Km, which is only exceeded within an area on the order of 20,000 Km² (.5 deg lat \times 2 deg long) around the point of release.

In the lower ionosphere there exists a sharp transition somewhere between 75 and 85 Km where NO⁺ and O₂⁺ are the dominant positive ions above, and water clusters of the type H⁺(H₂O) _{n} ($n=1-7$) are dominant below. The major source of molecular ions in the 70 to 90 Km region is photoionization of NO by L _{α} (1216A) radiation. Since the cross section of H₂O at L _{α} is about 1.4×10^{-17} cm², a H₂O column content of 10^{-17} molecules cm⁻² yields about 75% attenuation of L _{α} . For $\chi > 100$ ppmv, L _{α} radiation reaching the D region is thus reduced by at least 50%.

NO⁺ and O₂⁺ are precursor ions for reactions which lead to formation of H⁺(H₂O) _{n} . It is estimated that values of χ exceeding 100 ppmv would lead to a near complete conversion of O₂⁺ and NO⁺ (with recombination coefficients $\alpha_1 \sim 7 \times 10^{-7}$ cm³ sec⁻¹) to hydrated ions ($\alpha_2 \sim 3 \times 10^{-6}$ cm³ sec⁻¹) between 70 and 100 Km. Assuming a square loss law ($L = \alpha[e]^2$) and steady-state conditions, the corresponding reduction in electron density would be no more than $(\alpha_1/\alpha_2)^{1/2} \approx 0.5$. Combined with the L _{α} screening effects expected at $\chi = 100$ ppmv, a nominal reduction of order 75% in ionization density between 70 and 100 Km can be expected over areas of order 20,000 Km².

One of the net effects of H₂O photolysis is to create OH and H. The nature of the formalism adopted here precludes any prediction of the diffusion and redistribution of H atoms in the thermosphere. However, it can be crudely estimated that at least 100 metric tons of H must be added to the natural abundance of 50 metric tons above 105 Km to globally increase the attenuation of L _{α} radiation reaching the daytime D-region from the normal 1.6% to 10%, and that

the additional H must be replenished at least once a week to be maintained. This may be compared to the nominal 200 tons of H atoms introduced by every second stage HLLV exhaust. Since injection frequency will probably exceed 1 week^{-1} and H atoms will not have time to redistribute themselves uniformly over the globe in their 1-week thermospheric lifetime, a nominal 10% attenuation of L_Q may be assigned to this global effect as a lower limit until more quantitative estimates are available.

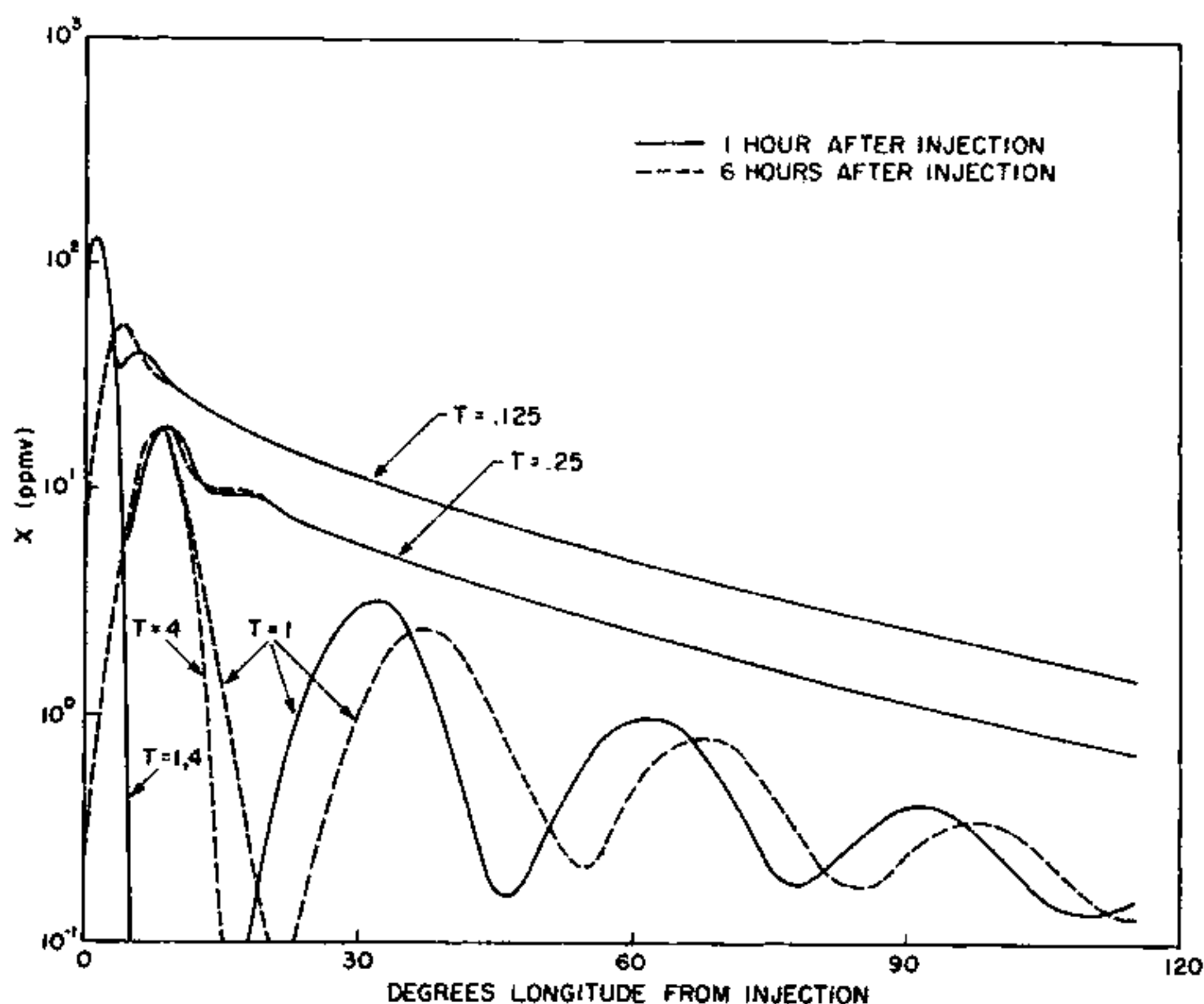

Figure 1. Steady-state longitudinal distribution of X at $\Delta t = 1 \text{ hr}$ and $\Delta t = 6 \text{ hr}$ after injection for $T = .125, .25, 1.0,$ and 4.0 days. (The latitude varies along each curve and is given by $\bar{v} (\lambda/\bar{u})$ in deg lat, where $\bar{v} = .5 \text{ deg lat day}^{-1}$ and λ is deg long from injection.)

Furthermore, it is qualitatively expected that hydrogen released by photolysis of H_2O can increase the loss rate of ozone between 75 and 95 Km, can significantly increase OH concentrations and accompanying airglow emissions, and also can act to increase nighttime E-region ionization by geocoronally-scattering L_α and L_β radiations after diffusing into the upper thermosphere. These effects of hydrogen released by H_2O photolysis may indeed comprise the most important upper atmosphere environmental impacts of discharging water in the 70 and 120 Km height regime by SPS-type activities and should be investigated further.

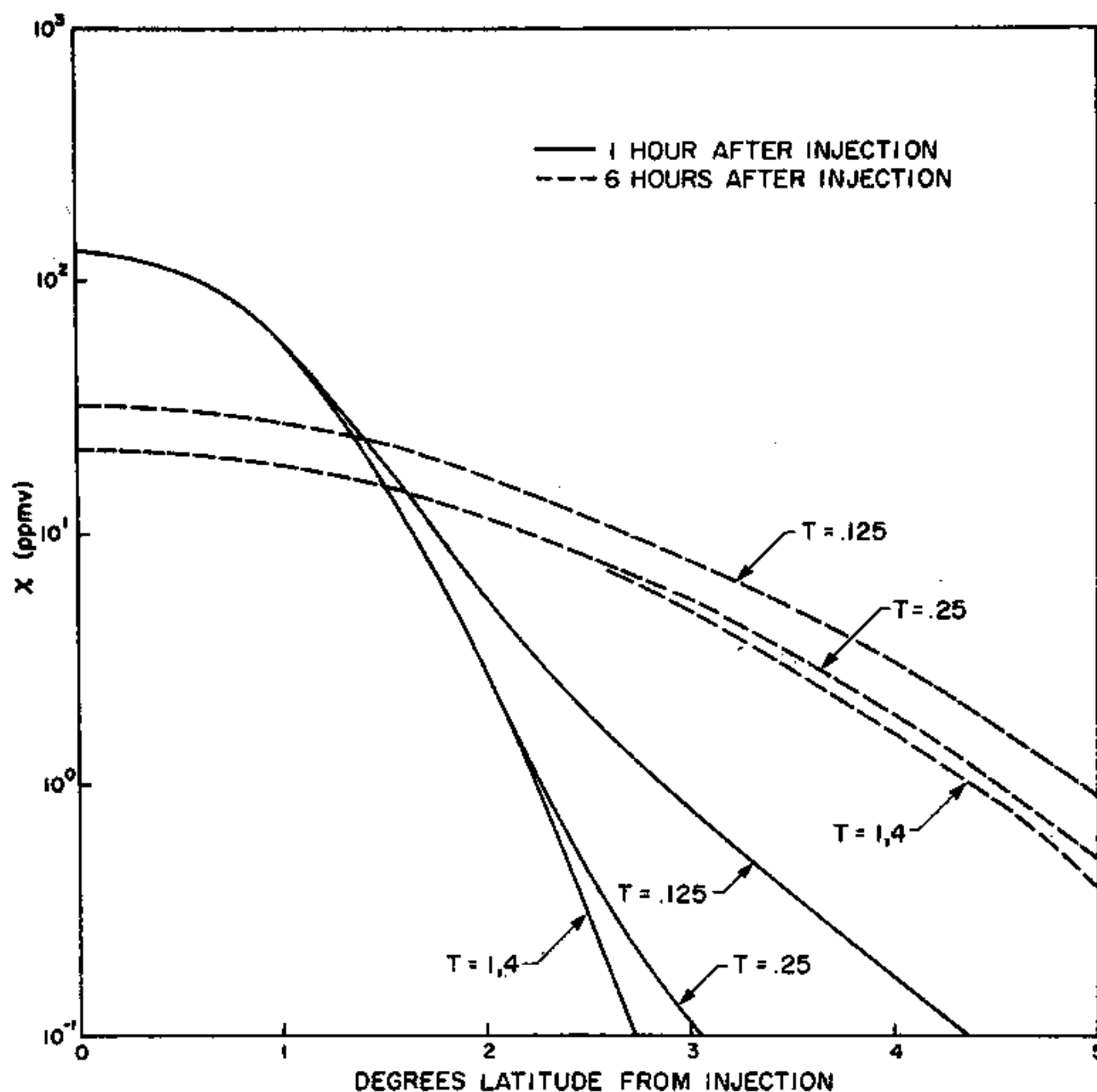

Figure 2. Steady-state latitudinal distribution of X at $\Delta t = 1$ hr and $\Delta t = 6$ hr after injection for $T = .25, 1.0,$ and 4.0 days. (The longitudes corresponding to each curve are $\bar{u} \Delta t / 24$ where $\bar{u} = 30$ deg long day $^{-1}$ and Δt is in hours.)

REFERENCES

Forbes, J.M., "Upper Atmosphere Modifications Due to Chronic Discharges of Water Vapor from Space Launch Vehicle Exhausts", in Space Systems and Their Interactions with the Earth's Space Environment, edited by C. Pike and H. B. Garrett, to be published in 1980.

ENVIRONMENTAL EFFECTS OF SPS: THE MIDDLE ATMOSPHERE

R.C. Whitten¹, W.J. Borucki¹, C. Park¹, H.T. Woodward¹, R.P. Turco², S.S. Prasad³, L.A. Capone⁴, and C.A. Riegel⁴

The heavy lift launch vehicles associated with the SPS would deposit in the upper atmosphere exhaust and reentry products which could modify the composition of the stratosphere, mesosphere, and lower ionosphere. In order to assess such effects, we have performed model simulations to assess the modifications, especially in a geographic zone centered at the launch and reentry latitudes. The models which we used were the following:

- (1) a one-dimensional photochemical model which extends from 10 to 120 km altitude and includes 35 chemical species (NASA TP 1002);
- (2) a two-dimensional photochemical model which extends from 80°N latitude to 80°S and from the surface to 90 km altitude; it includes about 25 species and parameterizes transport through mean meridional bulk motion and "eddy" diffusion coefficients;
- (3) a one-dimensional noctilucent cloud model which simulates ice particle nucleation, growth and evaporation, coagulation sedimentation and vertical eddy diffusion; the model, whose predictions of size and height distribution are in quite good agreement with the observational data available, is an outgrowth of a model of the stratospheric sulfate aerosol layer (NASA TP 1362);
- (4) a model for simulating the production of nitric oxide during atmospheric reentry of the HLLV's; after the entry trajectory is calculated the appropriate mass (including chemical kinetics), momentum and energy conservation equations are solved under the assumption that the flow field is very similar to that around a cone.
- (5) an ionospheric model which solves the chemical kinetic equations for 16 species of positive ions and 9 species of negative ions; clustering of water molecules to ions is included.

In order to provide estimates of the width of the long term zonal "corridors" in which the compositional changes might significantly change, we simulated 10 years of launch and reentry operations. The computed water vapor mixing ratio increase (ranging from 0.4% at 30 km to 8% at 80 km altitude) was nearly independent of latitude up to an altitude of 70 km. Above 70 km at the assumed launch latitude (30°N) it was higher than at other latitudes, about 15% excess at 85 km altitude. At latitudes north of 50°N and south of 10°N, the latitude dependence of the water vapor increase was insignificant. From these results we conclude that no "corridor" effect is likely except, perhaps, a very small one at altitudes above ~ 75 km. Similar calculations for the nitric oxide production and redistribution during reentry showed that the computed nitric oxide enhancement at the launch latitude is about a factor of 2 greater than that obtained from the one-dimensional model by assuming hemispherical averaging. The 10 year calculated decrease in the ozone column due to water vapor and NO deposition during launch was about 0.03% (hemispherical average) and the corresponding estimated change in mesospheric O(³P) was about 0.7%. The estimated ozone change likely to be caused by nitric oxide produced during reentry of the HLLV is about 1×10^{-3} % gain. Also, we compute a substantial increase in thermospheric hydrogen, about a factor of 2 globally averaged.

Noctilucent clouds can apparently form only at the high latitude mesopause because only there is the supersaturation of water vapor sufficient for their formation. Our preliminary estimates of the increase in optical depth at visible wavelengths due to noctilucent cloud formation from deposited water vapor is only $\sim 1 \times 10^{-4}$ in the noctilucent cloud zone (a very small fraction of the earth's surface). If the optical depth over the whole surface of the earth were increased by that amount, the estimated temperature decrease would be only about 10^{-3} K; the threshold for perceptible climate change is about 0.1K. However, immediately following launch the increase in optical depth can be quite large perhaps to $\tau \approx 25$ along the trail axis 1 hour after launch. However, the ice particles in the trail quickly spread and evaporate. Thus, one might expect a substantial contrail to form near the launch point and to dissipate in less than one day.

Our ionospheric calculations showed that on the global scale there would be only a small increase in electron density in the D-layer due to increased NO generated by reentry. Such increases could be very large (order to magnitude or more) in the region near the entry trail for times up to about 1 day.

- 1 - NASA-Ames Research Center, Moffett Field, CA 94035
- 2 - R and D Associates, Marina del Rey, CA 90291
- 3 - Jet Propulsion Laboratory, Pasadena, CA 91103
- 4 - San Jose State University, San Jose, CA 95129

SUNLIGHT REFLECTIONS FROM A SOLAR POWER SATELLITE OR SOLARES MIRRORS
SHOULD NOT HARM THE EYES
Dr. Michael T. Hyson
Bioinformation Systems - California Institute of Technology
Pasadena, California 91125

A Solar Power Satellite (SPS) located at geosynchronous orbit (GEO) could collect sunlight above the atmosphere and return 5-10 gigawatts of electrical energy to the earth using a microwave beam from an array of klystrons arranged as a transmitter one kilometer in diameter. The transmitter must point continuously at a receiver on the earth. During some phases of the SPS orbit, the transmitter would reflect an image of the sun to the ground. It has been suggested that the reflected beam could harm an observer's eyes. It is shown here that this problem is minimal. The reflection, while bright, would not be dangerous.

In the worst case, where the transmitter is assumed to be a perfect mirror reflecting the sun's image normal to the atmosphere, the total energy received by the eye would be 3.36×10^{-7} watts. The eye's optics would blur the 5.6 sec of arc image of the transmitter over a disk approximately 6 minutes arc in diameter, reducing the maximum intensity at the retina by 99%. A given cone in the retina would receive even less energy due to the constant random microtremors and microsaccadic movements of the eye muscles which move the retina over an area some 8 minutes of arc in radius, even during steady fixation. Therefore, very conservative estimates made here show that the reflections from the transmitter could be viewed safely for at least 3.2 hours and that the entire SPS structure could be viewed for a minimum of 1 hour. The Solares mirror is briefly considered and is shown to be safe to view for at least 2.4 minutes.

Keywords: Power generation, alternate energy sources, solar power satellite, solares mirrors, solar energy, extraterrestrial resources, space industrialization, SPS environmental impacts, eye movements, visual perception.

An SPS at geosynchronous orbit (Figure 1) will sometimes reflect sunlight to the ground. Solares mirrors may be used to provide increased solar insolation. It was found that the reflected light from these structures would not be at dangerous levels. The subtense of an SPS transmitter array would be 5.74 sec. arc (Figure 2). Worst cases were assumed; the SPS was treated as having albedo = 1, at GEO altitude, at the zenith, reflecting light into an 8 mm pupil of a dark adapted eye (Figure 3).

The illuminance at the eye is a function of the sun's intensity, the atmosphere's transmittance and the ratio of angular area of the structure and sun, i.e.:

$$\begin{aligned} & (\text{Structure Area/Sun's Area})(\text{Solar Constant})(\text{Atmosphere Transmittance}) = \\ & (5.74)^2 / (1.911 \times 10^3)^2 \times 1322 \text{ W/sq.M} \times .56 = 6.79 \times 10^{-3} \text{ W/sq.M} \end{aligned}$$

The amount of energy (E) entering the pupil would be:

$$E = (4\text{mm})^2 (6.79 \times 10^{-3} \text{ W/sq.M}) = 3.357 \times 10^{-7} \text{ Watts.}$$

HEW allows Class I laser doses of 0.0039 joules. It should be safe to look at the SPS transmitter image for:

$$3.9 \times 10^{-3} \text{ J} / 3.357 \times 10^{-7} \text{ Watts} = 194 \text{ minutes}$$

Similarly, the whole SPS structure [albedo 1.0] reflecting sunlight to the eye would have a subtense of 46 sec. arc and could be viewed for 3.01 minutes. The SPS would mostly be photo cells [albedo = 0.05] allowing exposures of 60.2 minutes. A 1 Km. Solares mirror 4000 Km. high with 51.6 sec arc. subtense could be viewed for 2.40 minutes, minimum.

Two factors reduce dose to the retina when viewing a point source. First, the eye's optics blur a point to a disk some 4 min. arc in radius, reducing peak intensity to 0.2% of the original [Figure 4, top]. Second, involuntary eye movements during fixation move the image over a retinal region some 8 min. arc in radius. The eye wanders further from the fixation point with time; so that the longer one looks, the lower the peak dose for any one area.

Figure 5 (top) shows that eye movements while fixating 1 minute wandered in an area one degree in diameter. At bottom is a magnified view of a 2 second portion of the top record, showing the eye moves in a series of small jerks, or saccades. Table 1 shows that motion reduces total dose half for 20 second exposures.

ANGULAR SUBTENSE OF SUN AND SPS TRANSMITTER

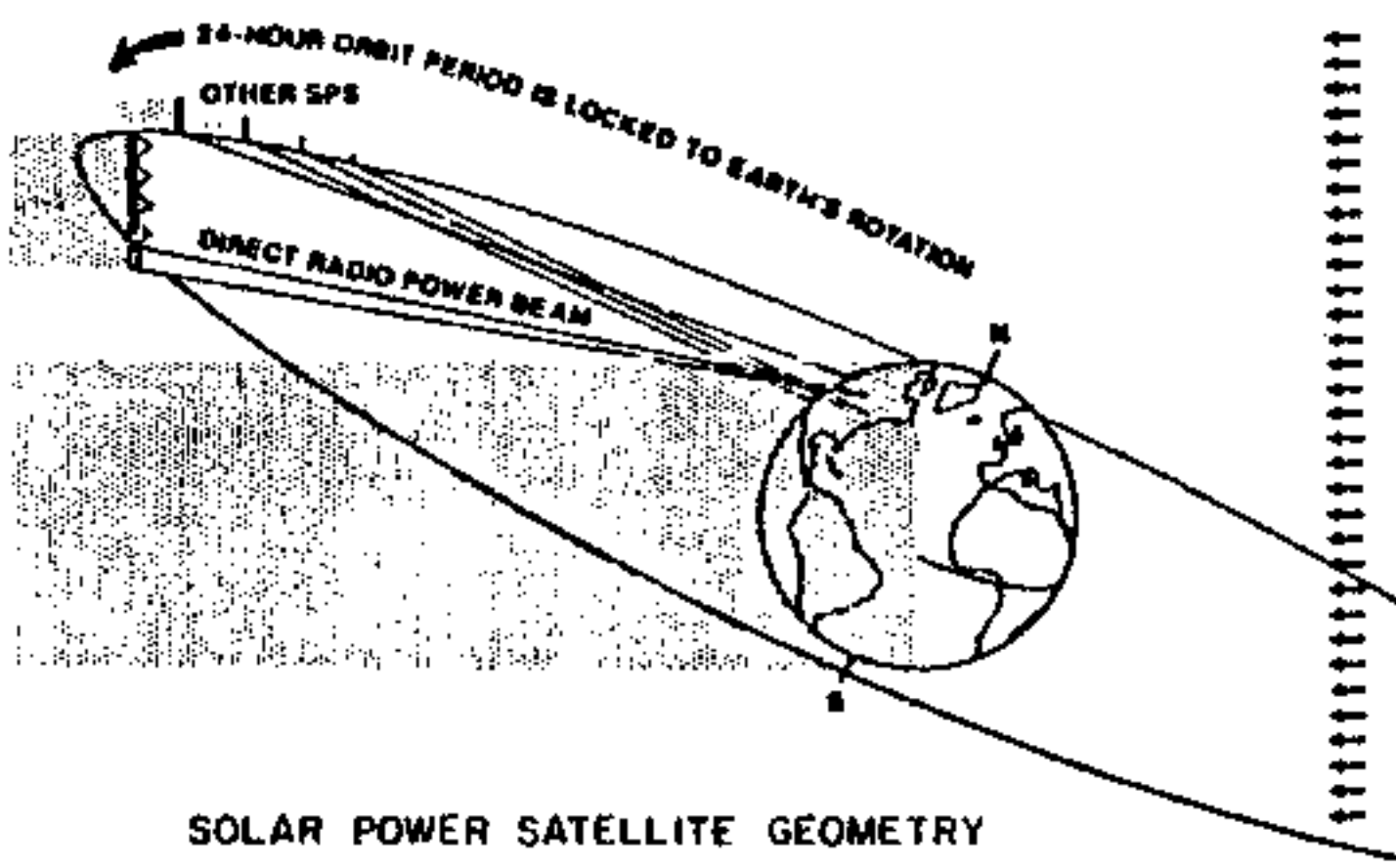

SOLAR POWER SATELLITE GEOMETRY

Fig. 1

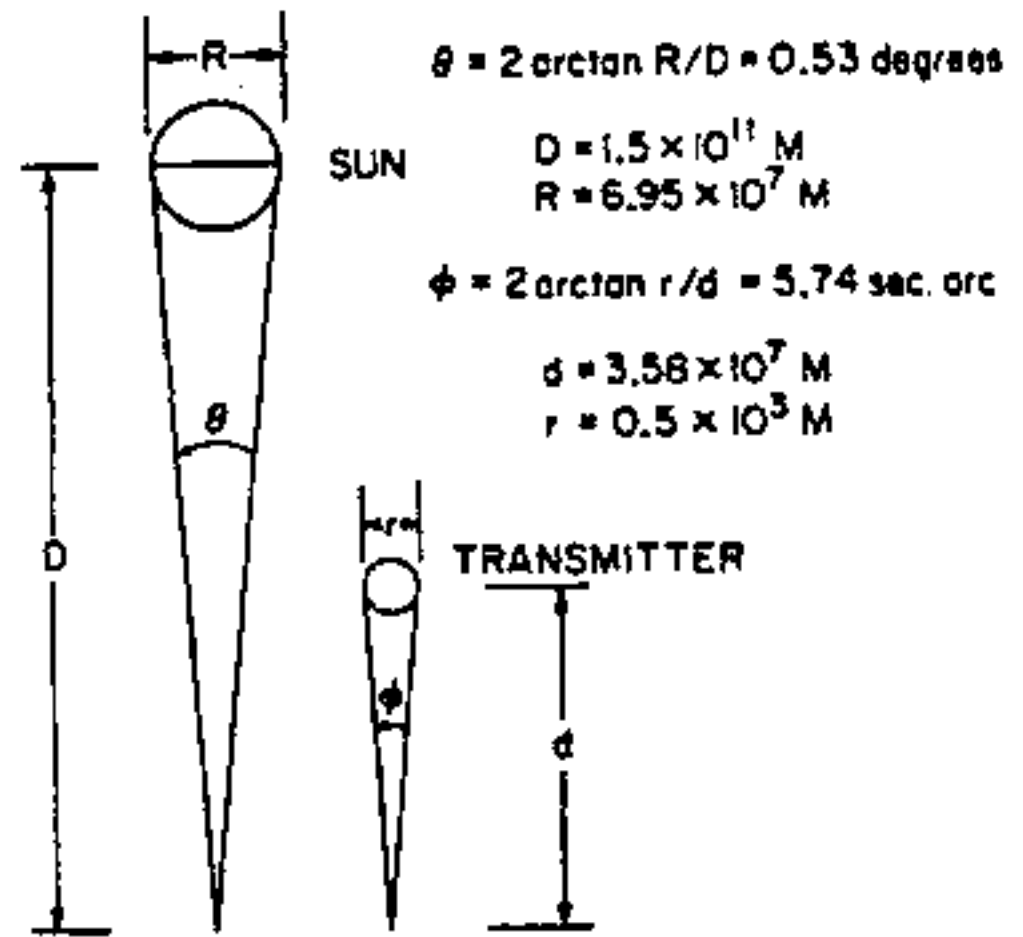
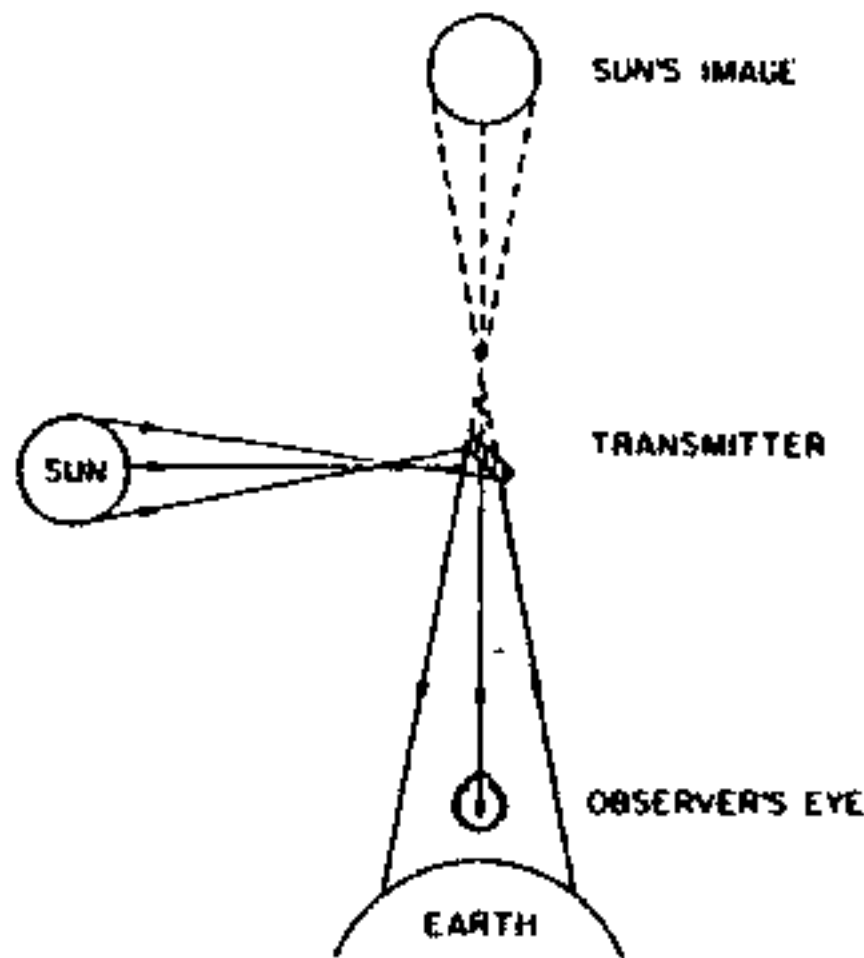

Fig. 2



RAY DIAGRAM FOR CALCULATION OF SPS BRIGHTNESS

Fig. 3

t	Prop. of Total		Moving Non-moving	Total Joules (Moving) Watts = 3.35×10^{-7}
	(Moving)	(Non-moving)		
1	2.43×10^{-3}	2.81×10^{-3}	.86	8.15×10^{-10}
5	11.10×10^{-3}	14.06×10^{-3}	.79	3.72×10^{-9}
10	19.46×10^{-3}	28.13×10^{-3}	.69	6.52×10^{-9}
20	28.98×10^{-3}	56.25×10^{-3}	.52	9.71×10^{-9}
40	32.32×10^{-3}	112.50×10^{-3}	.29	10.8×10^{-9}
60	29.34×10^{-3}	168.80×10^{-3}	.17	9.83×10^{-9}
80	25.70×10^{-3}	225.00×10^{-3}	.11	8.61×10^{-9}
100	22.51×10^{-3}	281.30×10^{-3}	.08	7.54×10^{-9}
120	19.90×10^{-3}	337.50×10^{-3}	.06	6.67×10^{-9}

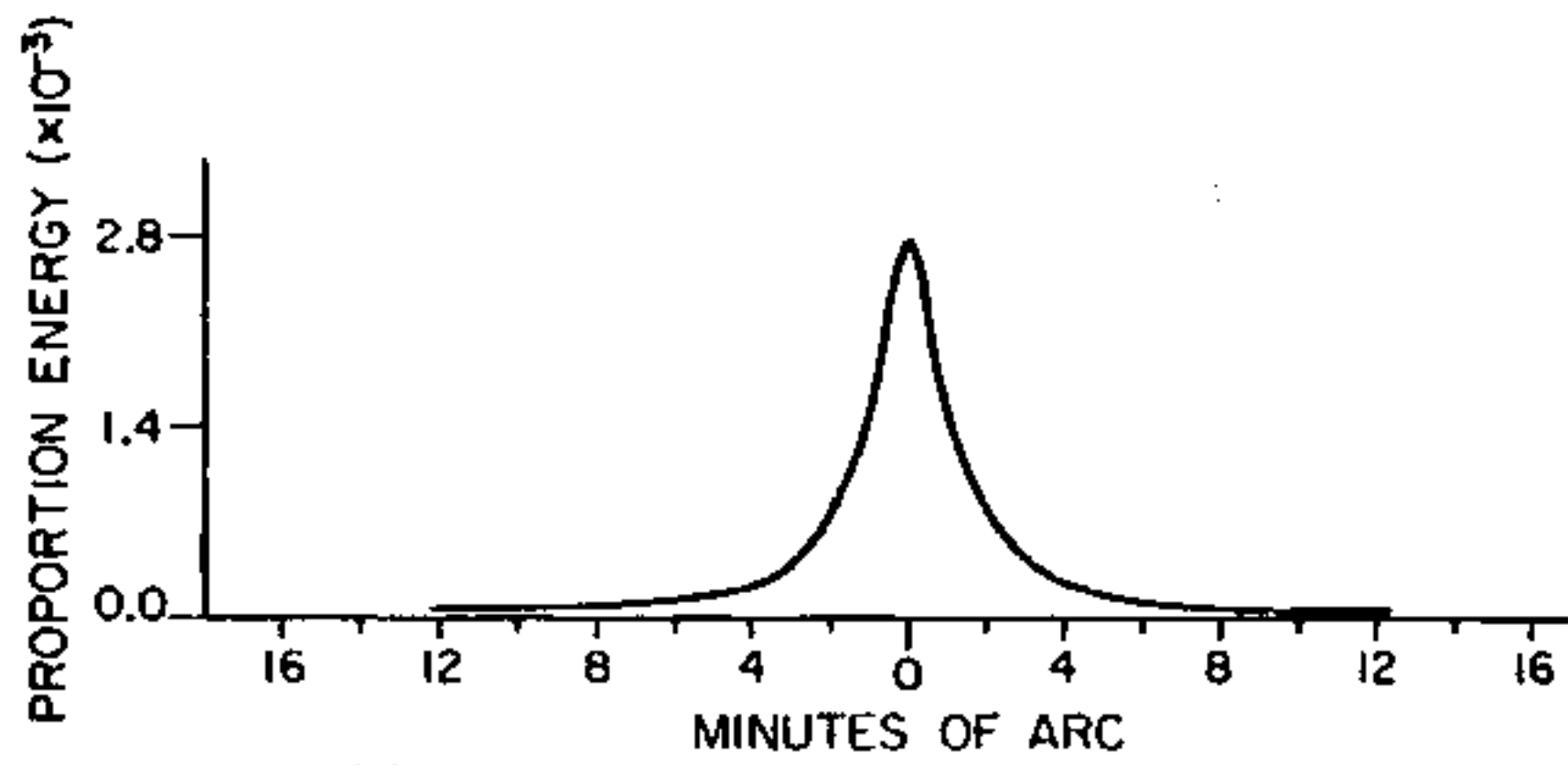

(a) ESTIMATED POINT SPREAD FUNCTION
(CROSS SECTION)

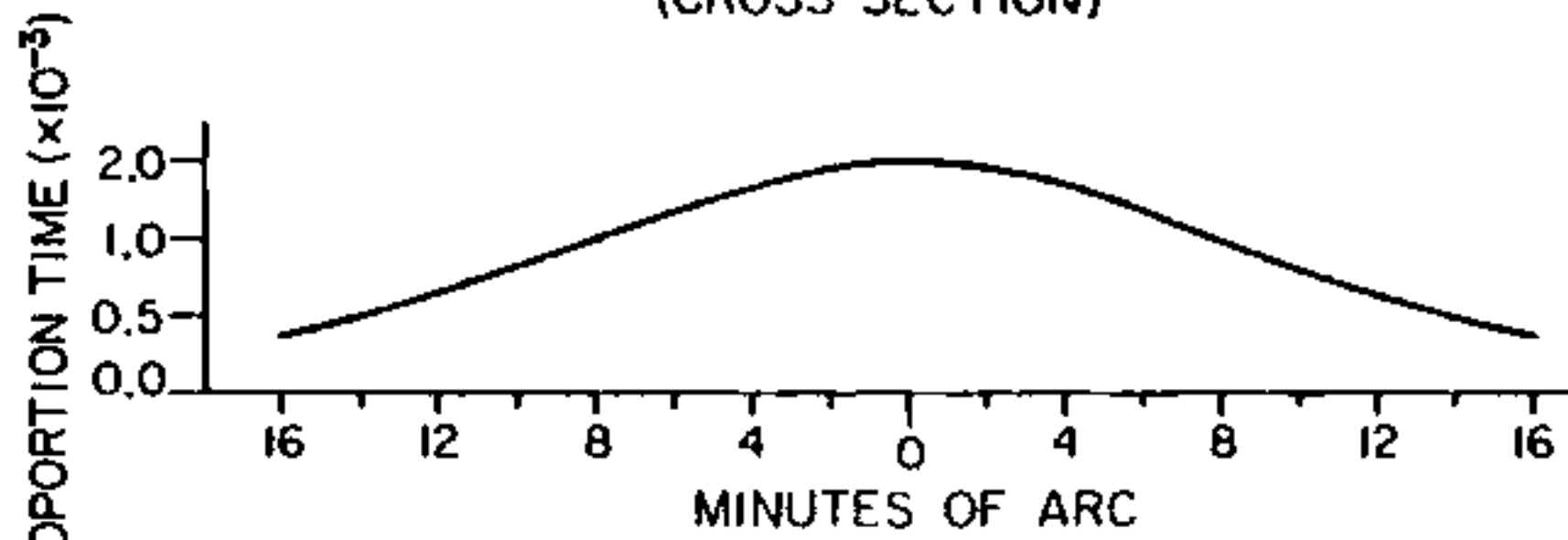

(b) EYE MOTION SPREAD FUNCTION
(CROSS SECTION)

Fig.4

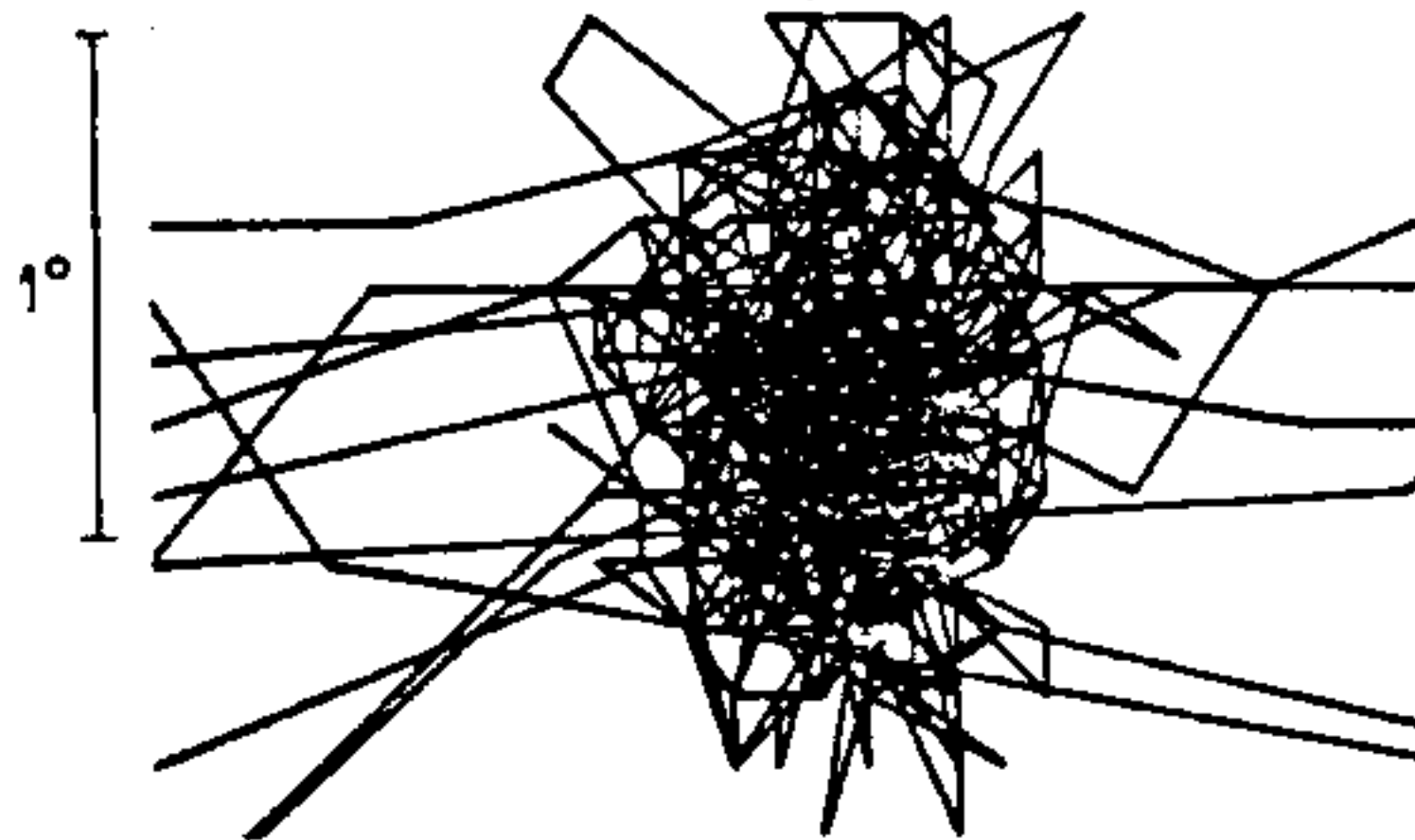

EYE MOVEMENTS DURING FIXATION

TOP: EYE MOVEMENTS DURING FIXATION OF
ONE MINUTE DURATION

BOTTOM: MAGNIFIED VIEW OF A TWO SECOND
SEGMENT OF THE TOP RECORD

Fig 5

CHARACTERIZATION OF REFLECTED LIGHT
FROM THE SPACE POWER SYSTEM

H. B. LIEMOHN, D. L. TINGEY, D. H. HOLZE, AND B. R. SPERBER
BOEING AEROSPACE COMPANY
SEATTLE, WA 98124

PRESENTED AT THE

DOE/NASA

SATELLITE POWER SYSTEM PROGRAM REVIEW
APRIL 22-25, 1980
UNIVERSITY OF NEBRASKA - LINCOLN

The development and operation of a Space Power System would place very large structures in orbit around earth for several decades. Sunlight reflected off such structures, particularly specular components from large flat areas, is expected to create ground illumination that will attract observers. In order to assure that this illumination does not exceed the irradiance tolerances of the eye, reflections from these satellites must be carefully controlled by vehicle orientation and surface specifications. The solar power satellite (SPS) at geosynchronous altitude (GEO) has 55 km² of glass covered solar cells that are oriented normal to the sun, as well as a 1 km² microwave antenna. Transportation of construction materials from low earth orbit (LEO) to GEO requires 23 Orbit Transfer Vehicles (OTVs) that have 1.6 km² solar panels oriented normal to the sun during their 6 month transits. The Staging Base (SB) at LEO, that accommodates OTV fabrication and cargo transfer, consists of 0.5 km arms protruding from a .44 km² open grid aligned with its orbit plane. Diffuse reflections would make the SB/OTVs readily discernible in the daytime and the OTVs and SPSs observable all night (except during eclipse). Sporadic specular glints would appear on the ground from the OTVs and SPSs near the midnight meridian, from the solar panel surfaces of OTVs during LEO fabrication, and from OTVs near LEO at dawn and dusk. The ground level irradiance has been evaluated for several unusually bright configurations using the Baseline System Design. For example, the present microwave antenna on SPS produces ground irradiance comparable to that from the full moon during operations around the equinoxes. Various modifications in the design and operation are suggested to reduce the brightness of these reflections.

Characterization of Reflected Light from the Space Power System

H. B. Liemohn, D. L. Tingey, D. H. Holze, and B. R. Sperber
Boeing Aerospace Company, Seattle, Washington

Limited terrestrial energy sources have led to investigation of Space Power Systems that would collect solar energy and beam it via microwaves to power stations on the ground. The Baseline System¹ consists of a Staging Base (SB) in low earth orbit (LEO), a fleet of Orbit Transfer Vehicles (OTVs) for movement of supplies from LEO to geosynchronous earth orbit (GEO), and assembly and operation of Solar Power Satellites (SPSs) in GEO. All of the structures would be very large in comparison with today's satellite sizes, and include large plane surfaces to collect solar energy.

Due to the enormous size of these spacecraft and their assembly vehicles, they may be viewed routinely by large numbers of ground observers. The brightness of sunlight reflections off various components changes markedly as the vehicles rotate along their trajectories. Many surfaces will undoubtedly be coated with optically diffusing material, but the present baseline configurations also include large flat areas that are specular such as glass, polished metal, and smooth composites. Owing to the large size, relatively low altitude (at LEO), and/or specularity, some reflections will be exceptionally bright.²

The level of ground illumination and particularly the concentration of radiant energy in observer's eyes needs to be assessed. For the most part, reflections will appear to ground observers as very bright starlike points of light in relatively dark night sky. Since contraction of the iris is controlled by overall illumination levels, the eye pupil may accept more light energy than desirable from these point sources, and produce abnormally high image irradiance at the retina. If the brightness of baseline vehicles exceeds accepted limits for eye safety, certain constraints on reflectivity of surfaces and the orientation of vehicles are the most likely procedures that would lower ground illumination.

This study reported in detail elsewhere³ has evaluated the components of the various Space Power System vehicles as presently defined to determine the reflectances which will significantly contribute to the ground illumination.

The calculation of reflected solar intensity from the various satellite system elements requires description of the elements and description of the geometry of potential reflectance paths. To reduce the calculation to a tractable problem only the nominally flat element surfaces were considered since the curved surfaces spread the light making their contribution negligibly small at the large orbital distances. Each surface is further defined by its approximate reflectivity and an estimate of its "flatness". In addition to determining that a surface is likely to reflect a significant intensity, it is also necessary to determine the conditions under which it will illuminate a portion of the earth. The orientation of each reflecting surface is therefore also necessary, so a number of convenient coordinate systems have been used.

The SPS at GEO has 55 km² of glass covered solar cells that are oriented normal to the sun, as well as a 1 km² microwave antenna. Transportation of construction materials from LEO to GEO requires OTVs that have 1.6 km² solar panels oriented normal to the sun during their 6 month transits. The SB at LEO, that accommodates OTV fabrication and cargo transfer, consists of 0.5 km arms protruding from a .44 km² open grid aligned with its orbit plane.

In determining possible ground illumination geometries, two cases are considered: 1) the reflecting surface rotates in orbit such that its orientation to the earth is constant (e.g., the satellite antenna), and 2) the orientation of the reflection surface to the sun is constant (e.g., the satellite solar arrays).

The ground irradiance produced by specularly reflected light from Space Power System spacecraft is given by⁴

$$H_s = \kappa N_{\odot} \frac{r_s a \cos(\alpha/2)}{R^2} \frac{\sigma^2}{(\rho + \sigma + \tau)^2}$$

where κ is the degradation due to atmosphere and/or instruments, $N_{\odot} = 2.0 \times 10^7$ watts/ster-m² is the average visual disk radiance of the sun, r_s is the specular reflectance of surfaces, a is the area of the surface in m², α is the angle between the incident and reflected rays, R is the distance from the SPS subsystem to the earth in meters, σ is the angle at the SPS subtended by the solar disk, ρ is the diffraction limit for coherent reflection from an element of SPS area δa m², and τ is the angular divergence of the solar image due to the fact that the reflectors are not optically flat mirrors.

The ground illumination from sunlight reflections off the Space Power System spacecraft have been evaluated for a variety of configurations, orientations, and operational conditions, that are thought to produce the brightest irradiances. A summary of ground irradiance levels that have been calculated is presented in the accompanying table.

The diffuse cases are all relatively bright in comparison with stellar sources. For example, the SPS in GEO casts an order of magnitude more light than Venus at its brightest. The OTV/SB combination in LEO is visible during daylight hours but, of course, is at too low an altitude to be illuminated at night.

The specular cases cited in the table produce much brighter ground illumination. However, this irradiance is restricted to small, fast moving spots. The actual duration of these "glints" of specular reflections varies from about one second for the OTV/SB in LEO to two minutes for the SPS antenna. An important consideration is the sudden onset of the specular irradiance compared to the much dimmer diffuse irradiance. Enhancements of 10^5 are common. An exceptionally bright specular reflection is produced by the backside of the OTV solar panels during LEO construction. Although perfectly flat solar panel surfaces are assumed as worst cases for the OTV and SPS, more realistic situations are represented by the curved or misaligned surfaces that are also analyzed

These worst case conditions in the table have ground irradiance levels that may exceed acceptable limits. Evaluation of the ocular irradiance levels that correspond to these ground irradiance levels is required to completely assess the reflection limitations that will be imposed on the Space Power System. Nevertheless, it is prudent to consider options for reduction of reflected sunlight from these vehicles. Possible methods for reducing reflections fall into three major categories.

Vehicle Orientation. Since the major ground illumination is produced by large flat surfaces on the OTV and SPS, it is appropriate to inquire about reorienting the vehicles to direct specular reflections away from earth. Since solar power collection falls with the cosine of the tilt angle, for example, an 8° tilt of the solar panels causes a 1% power loss, but specular reflections are shifted 16° off the sun-earth direction.

Surface Curvature. Most of the large surfaces that produce strong reflections are nominally flat in the Baseline Design. In practice, however, the vehicles are expected to flex under thermal and propulsion loads causing some misalignment of flat elements. Intentional misalignment of large solar panels

is also feasible. Both conditions will spread specular reflections and reduce the local intensity of ground irradiance by distributing the light over a larger area. For example a 5° misalignment results in a 100-fold reduction in ground irradiance.

Surface Quality. The Baseline Space Power System Design includes many surfaces that have specular characteristics in visible light. This surface quality can be altered for some of the applications without affecting the serviceability of the element. For example, the surface of the SPS antenna is an electrical ground plate that presently is polished aluminum; but its electrical properties at the microwave frequencies of interest would not be affected by surface roughening (etching) on the scale size of visible wavelengths to create a diffuse reflector.

Clearly there are options available to reduce ground irradiance from sunlight reflections off the Space Power System spacecraft. How effective they would be and how practical they are for overall performance and cost remains to be assessed.

1. Satellite Power System, Concept Development and Evaluation Program, Reference System Report, U. S. Department of Energy, Office of Energy Research and National Aeronautics and Space Administration, October 1978.

Solar Power Satellite, System Definition Study, Phase I Final Report, Contract NAS 9-15636, Boeing Aerospace Company Document D180-25037-3, April 1, 1979.
2. Livingston, L. E., "Visibility of Solar Power Satellites From the Earth", Johnson Space Center, NASA JSC-14715, February 1979.
3. Tingey, D. L. and H. B. Liemohn, "Characterization of Reflected Light from the Space Power System", Boeing Contract Report D180-25923-1 to Argonne National Laboratories, March 1980.
4. Liemohn, H. B., "Optical Tracking of Deep-Space Probes", ICARUS: International Journal of the Solar System, Vol. 9, No. 1, July 1968.

Summary of Ground Irradiance

Case	Condition	Midday M Dawn/Dusk D Night N	Range km	Irradiance W/m ²
Controlled Orientation - Worst Case Geometry				
Diffuse 1	OTV/SB in LEO	M	910	3×10^{-4}
2	SPS in GEO	N	35,700	1×10^{-5}
3	OTV Powered Near LEO	D	2,570	4×10^{-6}
4	OTV at 2 R _e 4 R _e	D	11,000	2×10^{-7}
		N	24,700	5×10^{-8}
Specular 1	OTV/SB in LEO around solstices	M	910	
	flat front solar panels			1.2
	flat back aluminum			19
	misaligned front (1.5°)			0.1
	misaligned back (1.5°)			2
2	SPS solar panel in GEO around equi- noxes	N	35,700	
	flat surface			0.03
	misaligned surface (5°)			0.0003
3	SPS antenna in GEO around equinoxes	N	36,000	0.01
4	OTV Powered Near LEO	D	2,570	0.19
5	OTV at 2 R _e 4 R _e	D	11,999	0.01
		N	24,700	0.002
Out of Control Orientation - Worst Case Geometry				
Specular 6	OTV in LEO	D	500	56
7	SPS in GEO flat back aluminum	N	36,000	0.4

PROTOTYPE ENVIRONMENTAL ASSESSMENT OF THE IMPACTS OF SITING AND CONSTRUCTION
OF AN SPS GROUND RECEIVING STATION

John Hill

Environmental Resources Group, 6380 Wilshire Blvd., Los Angeles, CA 90048

This report is a prototype assessment of the environmental impacts of siting and constructing a Satellite Power System (SPS) Ground Receiving Station (GRS). The objectives of the study are: 1) to develop an assessment of the non-microwave-related impacts of the reference system SPS GRS on the natural environment (microwave health and safety and communications impacts were not assessed); 2) to assess the impacts of GRS construction and operations in the context of actual baseline data for a site in the California desert about 250 kilometers north of Los Angeles referred to as Rose Valley/Coso; and 3) to identify critical GRS characteristics or parameters that are most significant in terms of the natural environment.

At the Rose Valley/Coso GRS study site (36°N latitude), the rectenna field, which is the area of the GRS where the microwave energy is collected and converted to electrical energy, would be an ellipse 13.4 km (N-S) by 10.0 km (E-W) and would enclose an area of about 10,500 hectares. An elliptical buffer zone, 1.35 km (N-S) by 1.0 km (E-W) would surround the rectenna field. The rectenna would contain about 2.5 million 3 meter by 10 meter panels connected end-to-end in long continuous rows. Approximately 450 workers would be required for 24-hour/365 days per year operation.

GRS construction is expected to require 25 months, with an average work force of 2,500 and a peak work force of 3,200. Major materials requirements include: 11 million tonnes of aggregates and ballast, 1.4 million tonnes of cement, 6.5 million cubic yards of concrete, 1.7 million tonnes of steel and 170,000 tonnes of aluminum. Other construction phase requirements include: maximum annual water demand of 3-15 million cubic meters (the wide range resulting from uncertainties in dust control and soil stabilization measures), and maximum incremental electrical demand of 16 MW.

Baseline environmental conditions in the Rose Valley/Coso study area are generally typical of the Basin and Range Physiographic Province which encompasses much of the southwestern United States. Air quality is quite good; ambient noise levels are very low. Soils tend to be clayey and silty in the valley bottoms, and more coarse and well drained, as well as sandy to stoney, away from valley bottoms. Surface water flow is predominantly ephemeral; a 400-hectare emergent underflow lake south of the study site is the only perennial surface water body in Rose Valley. The common Cresote Bush Scrub Community and Shadscale Scrub Community are the predominant vegetative types; no federally listed rare, threatened or endangered plant species are found in Rose Valley. A relatively abundant fauna is present, although without a great species diversity. As the site is along a migratory pathway, a sizable number of migratory birds are observed, for whom Rose Valley water sources are important habitats. No federally-listed endangered or threatened animal species are found in Rose Valley.

Key environmental issues identified include: probable adverse air quality impacts during construction; potentially significant soils and geologic impacts and constraints; substantial water demand during project construction; possible water quality impacts during construction and operation requiring a careful soil stabilization/drainage/erosion/sewage control problem; and total disruption of existing ecosystems at the GRS site, with reestablishment of these ecosystems

quite problematic.

Critical project parameters revealed include: the sheer size and intensity of use of the contiguous land area required by an SPS GRS; the lack of flexibility in siting individual rectenna structures once the rectenna field boundaries are established; the difficulties in finding suitable sites that do not conflict with other societal needs and values; uncertainties relating to re-establishing native ecosystems following total ecosystem modification during construction, and the related need for further research into microclimatic effects near the ground surface beneath the rectenna panels; and the proposed two-year GRS construction schedule, which has significant implications for peak air quality, water supply and biological impacts -- which could be reduced by extending the construction schedule.

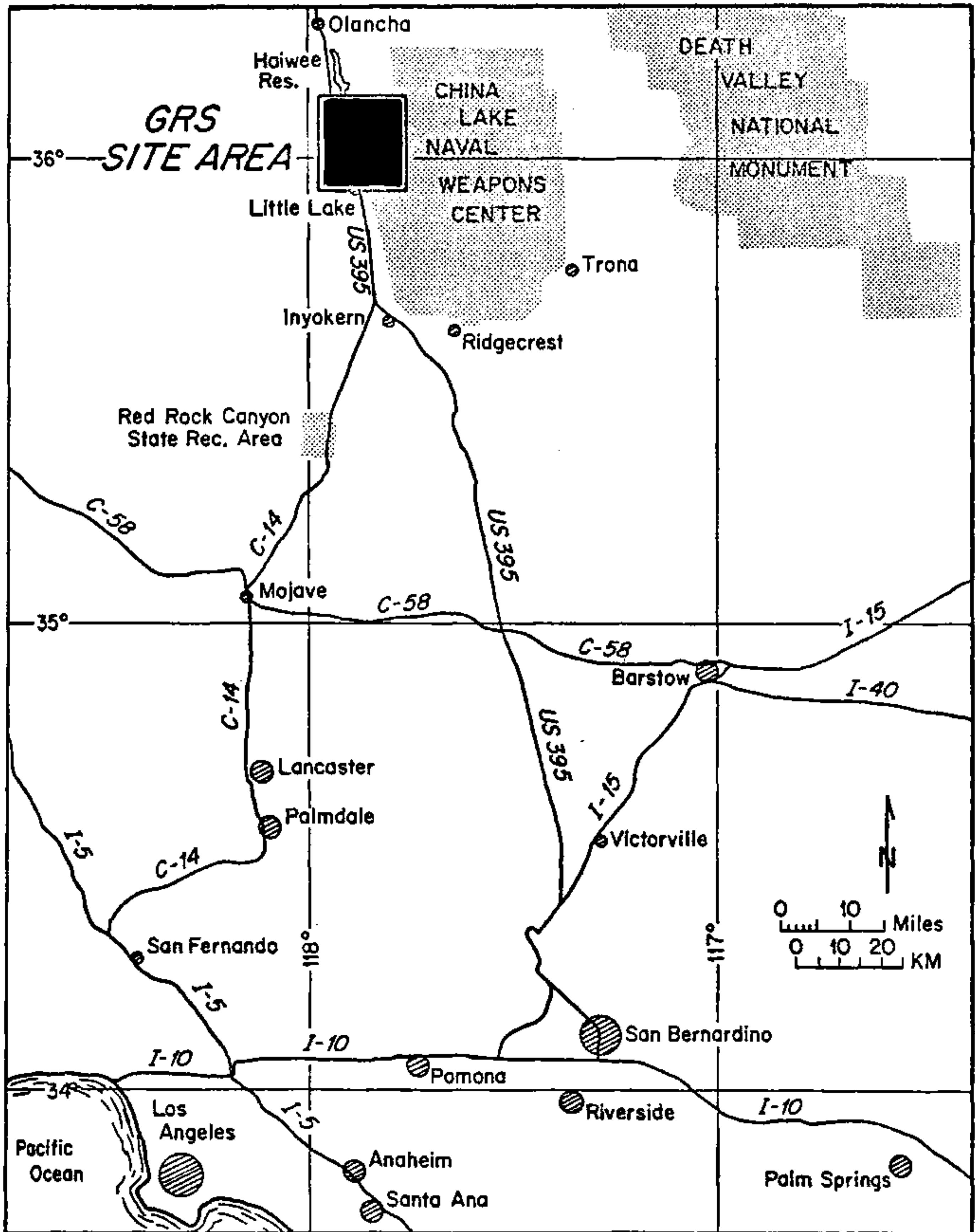

Figure 1 LOCATION OF GRS STUDY AREA

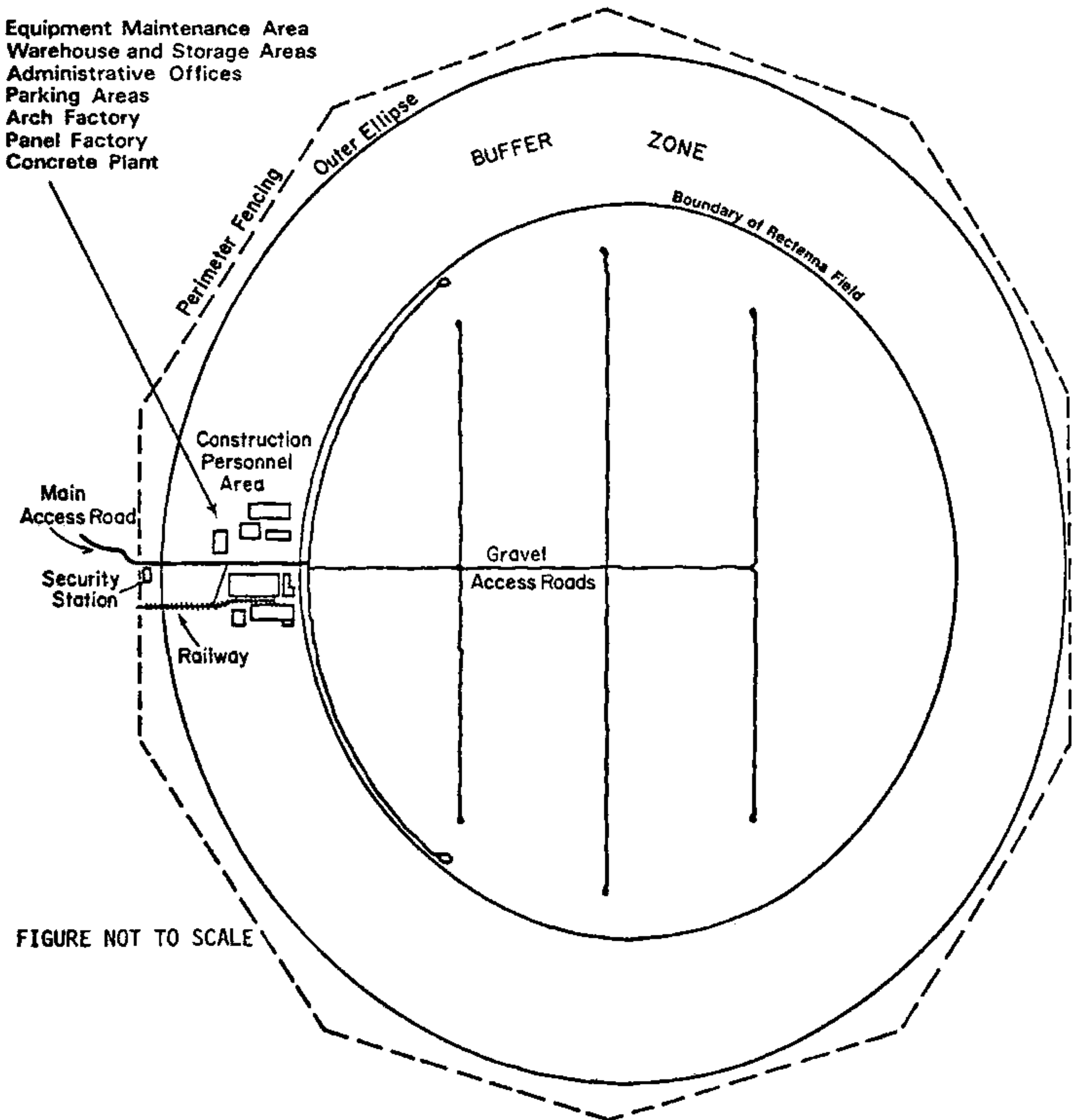

Figure 2 GRS CONSTRUCTION PHASE: SCHEMATIC LAYOUT
 (BASED ON FIGURES PRESENTED IN GENERAL ELECTRIC, 1979 AND ROCKWELL, 1979)

EFFECTS OF THE SPACE ENVIRONMENT ON THE HEALTH AND SAFETY OF SPACE WORKERS

Wayland E. Hull, Ph. D.

NASA Johnson Space Center - Houston, Texas

Large numbers of individuals are required to work in space to assemble and operate a Solar Power Satellite. Little is known about the physiological and behavioral consequences when large groups of men and women perform complex tasks in the vehicular or extravehicular environments over long periods of orbital stay time. The current data base is limited to United States and Soviet experiences involving only 2-3 persons at a time and for a maximum of 6 months. There are no specifically applicable data relating to inspace behavioral or social performance in populations of mixed gender.

Data relating to physiological performance are generally encouraging. The most disturbing consequences of exposure to the null-gravity environment relate to (1) a generalized cardiovascular deconditioning along with loss of a significant amount of body fluid volume, (2) loss of bone minerals and muscle mass, and (3) degraded performance of neural mechanisms which govern equilibrium and spatial orientation.

CARDIOVASCULAR DECONDITIONING:

The null-gravity environment contributes to redistribution of the labile body fluids. Such fluid shifts trigger reflex responses which serve to adjust total fluid volume. The influx of blood to regions of high compliance triggers a response in volume-sensing regions in the heart and central vessels, with the result that neurohormonal influences on the kidney mediate a loss of water and salt and reduce the total circulating blood volume. Such reflex accommodations were developed to maintain equilibrium in the face of naturally occurring temporal changes in body water, position, and activity. The physiological consequences of having triggered the blood volume control reflexes in null-gravity result in an inappropriate response because the evolutionary development of the system cannot account for lack of gravity. So long as the individual remains in the gravity-free state, the accommodative processes appear to interfere minimally with survival or performance. The inappropriateness of the accommodations to zero-gravity become evident when the individual returns to Earth where the force of gravity reestablishes hydrostatic columns at a time when total circulating blood volume is depleted. Refilling the dependent regions of the lower limbs and abdomen from a diminished total fluid supply results in the presentation of an inadequate volume to the heart for the perfusion of vital organs. The processes leading to such orthostatic hypotension, or the deficiency of volume for tissue perfusion, lend themselves to certain counteractive measures. Countermeasures include (1) application of pressure on the lower limbs and abdomen to reduce the volume available into which blood can pool, thus conserving the reduced blood volume, or (2) drinking excess water and salt while pharmacologically or otherwise inhibiting water and salt loss by way of the kidneys.

DEPLETION OF BONE MINERALS AND MUSCLE MASS:

The release from gravity reverses the physiological mechanisms that serve to build bones and strong muscles. Bone calcium is lost from the skeleton to the plasma and thence from the body via wastes. Muscles lose some strength as structural materials in muscle cells are lost from the muscle mass of the body. The anti-gravity or postural muscles are especially affected. There

is no evidence that the rate of bone calcium loss diminishes or terminates during weightless exposure lasting as long as 3 months. Much research on the problem of space flight osteoporosis remains to be done. At present the countermeasures used include the provision of adequate bone replacement salts in the diet along with muscular exercise in an attempt to simulate the forces on bones and muscles normally provided by gravity. Exercise appears to be beneficial in moderating the loss of muscle strength and mass.

NEUROSENSORY DISTURBANCE:

For reasons as yet unexplained, the sensory systems affected by pressure, acceleration, position, and visual patterning appear to lose the fine tuning of their normal integrated interplay. Sensory confusion occurs below the level of consciousness and the conflict of incoming information may give way to dysfunction with resulting space motion sickness. The disturbance appears early in the exposure to null-gravity. Stomach awareness, malaise, and vomiting can occur. The symptoms appear to wane as exposure continues, and in the Skylab experience, the problems of orientation and "space motion sickness" disappeared after a few days. The most effective countermeasures presently available are drugs which dull the acuteness of the symptoms without impairing performance. Much more research must be done to understand the processes involved in this malady and to develop more effective countermeasures.

OTHER EFFECTS:

There have been measurable changes in the total mass of circulating blood cells, in several parameters of body fluid composition and regulation, and in the endocrine and immune systems. These latter changes are presently considered to be adaptive and not likely to interfere with the individual's ability to live and work productively in space.

An interesting relation can be drawn between the rate of onset of effects during exposure to weightlessness and the rate of recovery upon return to Earth. The rapid onset of cardiovascular and neurological disturbances is mirrored in rapid recovery. Disturbances in bone and muscle appear less rapidly, reflecting the relative sluggishness of these biochemical changes at the cellular level. However, the observed changes all appear to operate within the predictable range of physiological performance. All changes observed have been shown to be reversible. Although much more research has yet to be done on the long-term effects of space flight on man, there is no compelling evidence to discourage continued lengthening of the null-gravity exposures or increasing the complexity of tasks to be accomplished in space.

HAZARDS TO SPACE WORKERS FROM IONIZING RADIATION
IN THE SPS ENVIRONMENT

John T. Lyman

Biology and Medicine Division - Lawrence Berkeley Laboratory
Berkeley, California 94720

This report presents a compilation of background information and a preliminary assessment of the potential risks to workers from the ionizing radiation encountered in space. The report (1) summarizes the current knowledge of the space radiation environment to which space workers will be exposed; (2) reviews the biological effects of ionizing radiation considered of major importance to a SPS project; and (3) discusses the health implications of exposure of populations of space workers to the radiations likely to penetrate through the shielding provided by the SPS work stations and habitat shelters of the SPS Reference System.

For the construction and maintenance of 60 SPS systems, each with a 30-year lifetime, it is estimated that about 50,000 man-years in space will be required. The hazards to the workers from the space ionizing radiation have been evaluated based upon the reference system scenario for a geosynchronous orbit (GEO) construction site. This will result in about 90-percent of the worker-years being spent in GEO. The number of maintenance workers needed per satellite is a large factor in the total space effort that is required.

The three phases of the SPS mission, low earth orbit (LEO), the transfer ellipse (TE), and GEO will result in radiation exposure of space workers with different situations of time dependence, radiation quality, and ease of predictability. The various components of the radiation environment are described, and those important to each mission phase identified.

LEO which is used for a staging area is fairly well shielded geomagnetically from the galactic cosmic rays (GCR) and the solar particle event (SPE) radiation. The major radiation hazard in LEO is from the trapped protons at the South Atlantic anomaly.

During the transfer between LEO and GEO the workers must pass through the high radiation regions of the Van Allen belts. Depending on the trajectory chosen, either the bremsstrahlung radiation from the electrons or the protons can be the major contributor to the total dose equivalent. Lower dose equivalents are expected to be received in the trajectories that minimize the proton dose.

In GEO the major contributor to the total dose equivalent will be the bremsstrahlung radiation from the electrons in the outer radiation belt. The GCR radiation is a fairly constant background of particle radiation that will be only slightly affected by the shielding of the reference system. Of the GCR, protons and helium ions are the largest contributors to the total flux, however, the HZE particles are more important in the calculations of the total dose equivalent. In addition, HZE particles may cause important biological effects not seen with low-LET radiations. Therefore the use of a quality factor to arrive at the dose-equivalent may result in underestimation of the health risks of exposure to HZE particles.

Most of the dose equivalent will be received in GEO and in the transfers between LEO and GEO. SPE radiation is expected to significantly increase the

total dose equivalent in about 10-percent of missions of a 90-day duration.

Early health effects of radiation (those occurring within hours, days, or a few weeks of exposure) assume clinical significance with whole-body doses only in excess of about 150 rem. Such exposures are likely to be encountered rarely if at all in close-in space missions.

A potential increase in the risk of cancer is the principal and most serious late effect of exposure to ionizing radiation. Radiation causes an increase in the cancer risk at doses greater than 50-100 rem. At lower doses, it is difficult or impossible to demonstrate an increased risk even in large, exposed populations.

The low-LET radiation dose expected will be below the threshold for radiation-induced cataracts and the probability of any serious risk of cataracts from HZE particles seems low. Other effects considered are genetic and teratogenic effects, life-span shortening, and effects on fertility and the skin.

The probability of an individual of having a radiation-induced cancer will depend on many factors, included would be the total lifetime dose-equivalent, dose rate, duration of exposure, and the age, sex, and host susceptibility. The majority of the lifetime dose-equivalent will be from the space radiation. Therefore for this consideration, the dose per mission is not as important as the total career dose. The dose per mission would be expected to be a constraint on the total number of missions allowable for a space worker. If a worker spends five years in space, protected by the shielding of the reference system, it is anticipated that the potential risk of having cancer may be increased about 12 percent.

The health effects of ionizing radiations must be considered in the context of the potential health effects of other physical and chemical agents in the space environment. Such competing effects may interact to mask, enhance or diminish the induction of health effects which may occur under exposure to low-level radiation delivered at a slow rate.

LATE BIOLOGICAL EFFECTS OF HEAVY CHARGED PARTICLES:
CATARACTS, VASCULAR INJURY AND LIFE SHORTENING IN MICE
E. J. Ainsworth - J. G. Jose - M. E. Barker - E. L. Alpen
Donner Laboratory, Lawrence Berkeley Laboratory and School of Optometry
University of California, Berkeley, California 94720

Manned space flights are now a reality and may increase in the future in connection with use of advanced technologies, such as satellite power systems (SPS) to generate electricity. However, many of the risks associated with extended habitation in a space environment remain undetermined. Of particular concern at this time are the hazards to space workers that might result from exposure to high energy heavy ion particles (HZE). Less is known about the biological consequences of HZE than about other types of radiations encountered in space. Conventional types of shielding used for radiation protection do not shield out these particles. No data are available currently to assess lens damage and repair after low doses of HZE particles. Thus, more information is needed about biological effects of HZE in order to assess their potential adverse health hazards. Of considerable importance are the potential effects of HZE particles on the crystalline lens of the eye, because this tissue has proven susceptible to x- and gamma rays and particularly susceptible to the action of other forms of high LET radiation such as fission-spectrum neutrons. Because carcinogenic effects and blood vessel (vascular) damage are also of great importance for radiation risk assessment, several animal experiments are in progress to evaluate dose-response relationships for tumor-induction/promotion and for vascular injury. This presentation concentrates on cataract productions, yet preliminary results on carcinogenic and vascular effects are presented for perspective. A fundamental question addressed by several ongoing studies at Berkeley is the extent to which the biological effects of HZE particles are more or less hazardous than fission neutrons, because fission neutrons and densely ionizing alpha particles are considered the most hazardous radiations to man.

The three radiation sources we use in these studies are 250 kVp x-ray machine, the Lawrence Berkeley Laboratory Bevalac, and the 184 inch cyclotron. All mice evaluated for cataracts by slit-lamp biomicroscopy were given either head only or upper body exposures to charged particles or x-irradiation. Fully stripped heavy charged-particles were obtained from the Lawrence Berkeley Laboratory Bevalac, a national facility. The Bevalac combines two accelerators; the SuperHILAC, a heavy ion linear accelerator and the Bevatron, a proton synchrotron. Particles are first accelerated to appropriately 7-9 MeV in the SuperHILAC and are then injected into the Bevatron thru a transfer line where maximum energies obtained are in the range of 2 GeV. ^{12}C , ^{20}Ne , ^{40}Ar , ^{56}Fe ions were extracted from the Bevalac at a preselected energy.

Eye examinations were performed by first sedating each animal with Diabutal. Dilation was achieved by the use of one drop of 1% Tropicamide. The lenses were then observed with a slit-lamp biomicroscope, and assigned a severity score of 0.0-4.0. The observer did not know the type or dose of radiation that the animals had received. Preirradiation screening of animals for "spontaneous cataracts" was accomplished on many animals and the number rejected was nil.

Cataract evaluations have been done on several strains of hybrid mice involved in five different experiments, only two of which were dedicated cataract experiments.

In Experiment II animals were irradiated with 10-100 rad of spread Bragg peak argon ions (570 MeV) and were evaluated at 7,8,9 and 18 months after irradiation. Nearly 44% (48/108) of the mouse eyes developed some opacification by

nine months post exposure. The results suggest that the severity of opacification is dependent upon dose. At nine months, the animals with the most severe opacification are those that had received the highest doses of irradiation. Also, the results suggest that the latency is dependent upon the dose. At nine months post irradiation only one animal in the 10 rad group had begun to develop lens opacification. We therefore evaluated the animals again after a period of 18 months (Table I). At that time, all mice given 10 rad showed lens opacifications. The average opacification score was similar (2.6-2.9) at that time, in mice that received 10, 25, or 50 rad, and we assume that the lack of dose-dependence is due to a plateauing of the response by this time. We will continue to examine these animals to determine if the cataractogenic process proceeds further in these mice.

Table I Average Cataract Scores of the Posterior Lens in LAF₁ Female Mice at 18 Months After Exposure to ⁴⁰Ar ion (4 cm SOB)

<u>Dose (rad)</u>	<u>No. Eyes</u>	
0	31	0.5*±0.09
10	21	2.7 ±0.14
25	20	2.9 ±0.18
50	22	2.6 ±0.14
100	13	3.6 ±0.14

*significantly ($P < 0.01$) different from all irradiated groups.

Experiment IV compares the effects of plateau irradiation of animals irradiated with argon, neon, carbon and also x-ray. At the onset of the experiment it was postulated that HZE particles might have an RBE of 10 in comparison with x-radiation. Six months after the animals had been irradiated, only minimal lens changes were observed. No dose-response relationship was apparent, and no significant differences emerged among the lenses irradiated with the different particles. This situation changed at 9 months after irradiation. As is apparent from Figure 1, the degree of opacification is strongly dependent upon the ion used. The dose scale for x-irradiated mice must be multiplied by 10. At the highest dose (90 rad), all types of particles produced unmistakable opacification, the extent of which is correlated with the expected LET dependence of the response. That is, the degree of opacification increased progressively with increasing estimated values of LET; namely argon, neon and then carbon. From these data, one cannot accurately determine the RBE for HZE particles in relation to x-radiation. There is no question that the RBE is less than 10. Whereas, the x-ray animals given 900 rad had developed total lens opacification at 9 months, the 90 rad argon-induced cataracts were approximately grade 3, the neon about grade 2 and carbon grade 1. If one considers the data in Figure 1, one observes that 60 rad of argon radiation induces about as much opacification as 300 rads of x-rays; thus, the RBE may be of the order 5. The RBE for carbon would then be about 159/90 or less than 2.0 at 9 months. If average cataract scores plateau with time, estimates of RBE will be time dependent.

Preliminary results will be presented concerning radiation-induced life span shortening after exposure to 400 MeV spread peak ¹²C or ⁶⁰Co gamma radiation. At one year after a single dose of 240 rad, the cumulative mortality is similar to that produced in the same mouse strain given the same dose of fission

neutrons. Stopping ^{12}C or ^{20}Ne ions also appear approximately as hazardous as fission neutron for production of damage to mouse coronary blood vessels and heart muscle.

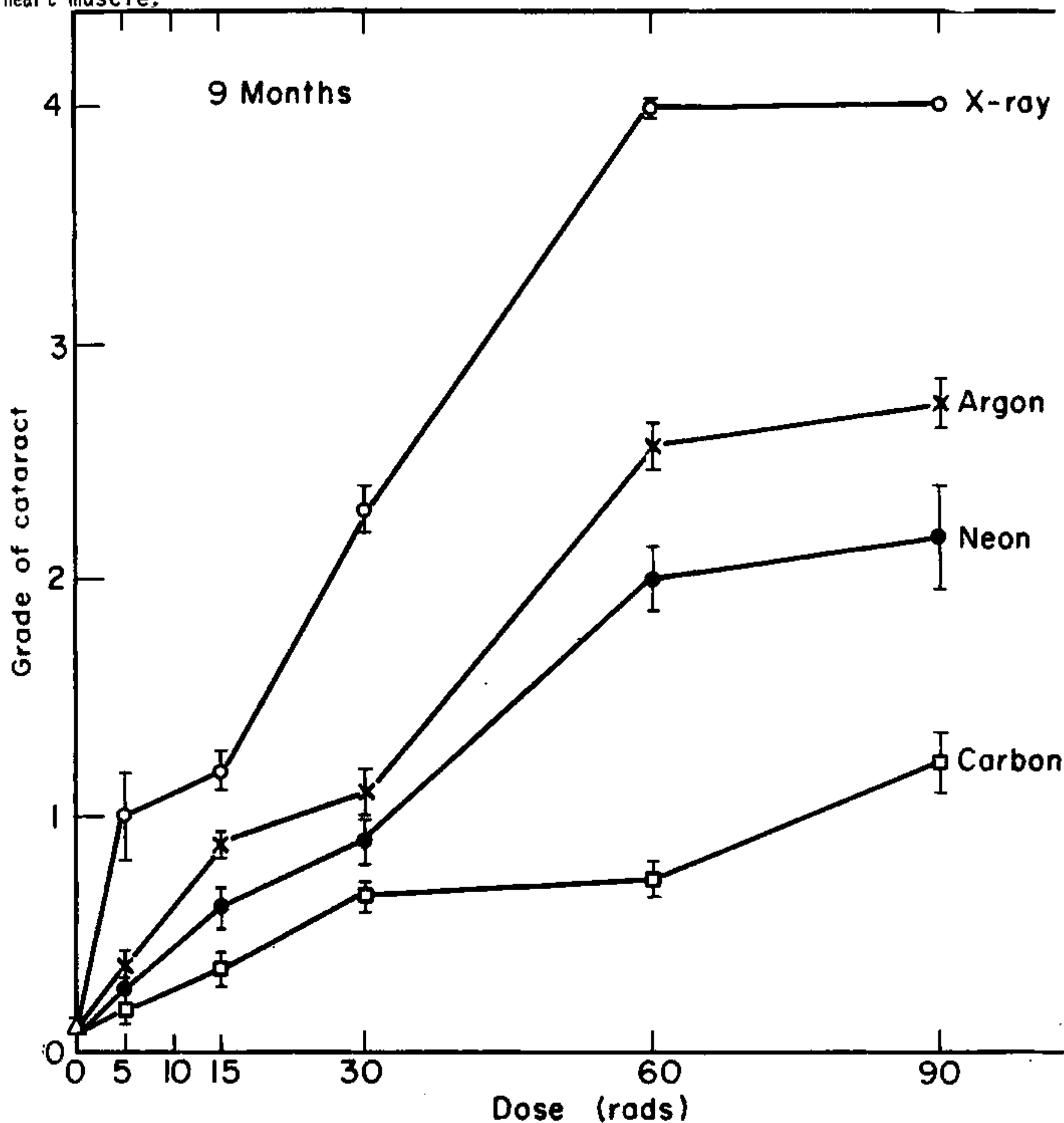

Figure 1. Average cataract severity at 9 months after photon or charged particle irradiation in CB_6F_1 male mice. Average scores and standard errors are based on 32-38 eyes per dose group. Unirradiated controls (38 eyes) had an average score of 0.09 ± 0.03 at 9 months.

IONOSPHERIC OBSERVATIONS: ARCHIVED DATA AND THE HEAO-C LAUNCH

Michael Mendillo and C. C. Chacko
Astronomy Department - Boston University
Boston, Massachusetts 02215

Sustained, large-scale rocket launch campaigns of the kind envisioned for the proposed Satellite Power System will affect the Earth's environment to an unprecedented degree. The problem of evaluating the consequences of such a campaign is a complex one due to the very large number of chemical, mechanical and electromagnetic processes operating in the Earth's atmosphere, ionosphere and magnetosphere. We have undertaken a two-fold course of study of ionospheric observations with a view towards documenting some of these effects without need of resorting to costly new experiments.

Our first approach centered on a search for ionospheric depletions ("holes") that may have been detected during routine observations of the ionosphere from stations close to NASA launch sites. Using a list of over 400 rocket launches carried out by NASA between November 1958 and August 1978, the vast archives of ionosonde records stored at the World Data Center in Boulder, Colorado, were examined for rocket-induced ionospheric changes. Most of NASA's larger rockets were launched from the Kennedy Space Center, and thus the ionograms from Cape Canaveral, Grand Bahama Island, San Salvador, Cuba and Jamaica were the prime ones examined in our search for "retroactive experiments." During the years 1959 to 1971, a total of 156 major rocket launches occurred from KSC. Of these, only 5 cases of relatively clear rocket-associated effects were found. With the closing of the Grand Bahama Island station in 1971, the last ionosonde capable of monitoring KSC launches disappeared. Data from Cuba, Jamaica, KSC, Grand Bahama Island and San Salvador are being reduced to describe the spatial and temporal extent of the resultant disturbance.

A more promising avenue of study concerns the transformation of a scheduled rocket launch into an "experiment of opportunity" by establishing a temporary network of observing sites in regions close to the rocket trajectory. The launch of NASA's HEAO-C satellite on 20 September 1979 provided an extraordinary opportunity to mount such a campaign. The event was monitored by a network of 12 satellite radio beacon observatories, 2 incoherent scatter radars, an airborne optical observatory, 3 ground-based air-glow systems, and over 150 radio propagation monitoring sites using both professional and radio amateur facilities. The ionospheric depletion caused by the rocket exhaust cloud spanned a region of approximately 2 million sq. km. The total electron content depletions near the rocket trajectory showed more than an 80% reduction from ambient conditions. The extensive network of diagnostic systems assembled for the event provided the most complete description yet obtained for a large-scale, rocket-induced ionospheric hole.

FIGURE CAPTION: (A) Schematic representation of rocket trajectory and various ray paths to geostationary satellites (SIRIO, ATS-3 and ATS-5). (B) Sample total electron content (TEC) measurements made along slant ray paths to the SIRIO satellite. (C) Ionospheric TEC data from six stations displayed via iso-level contours on a time/latitude grid. The development of the hole is marked by the rapid transition of the contours from basically vertical lines (normal nighttime decay) to essentially horizontal lines (showing a trough-like minimum). The TEC data are normalized to 57.6 units (10^{16} el/m²) at 05:00 U.T., with subsequent contours spaced at -3.2 units. The launch occurred at 05:28 U.T.

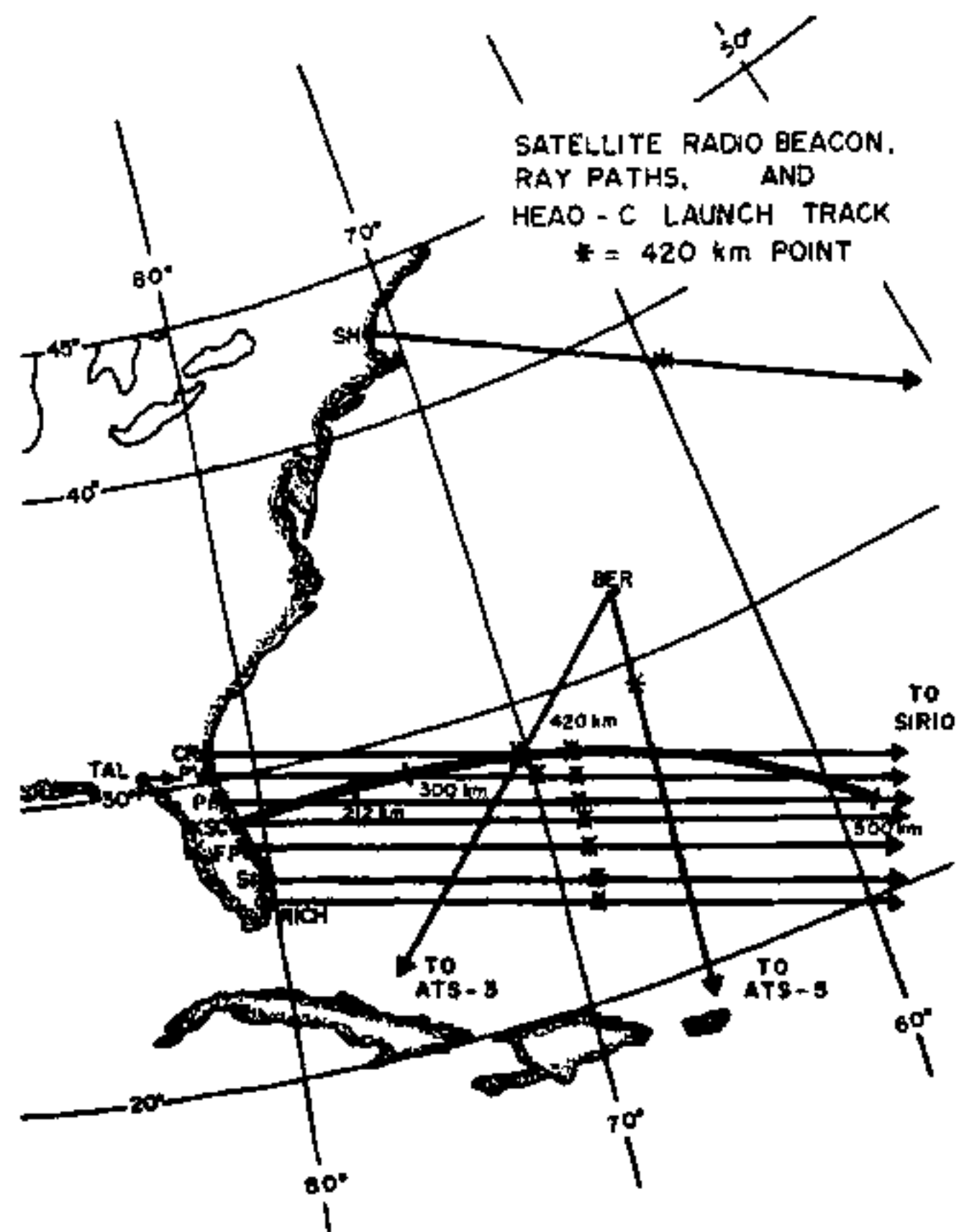

(A)

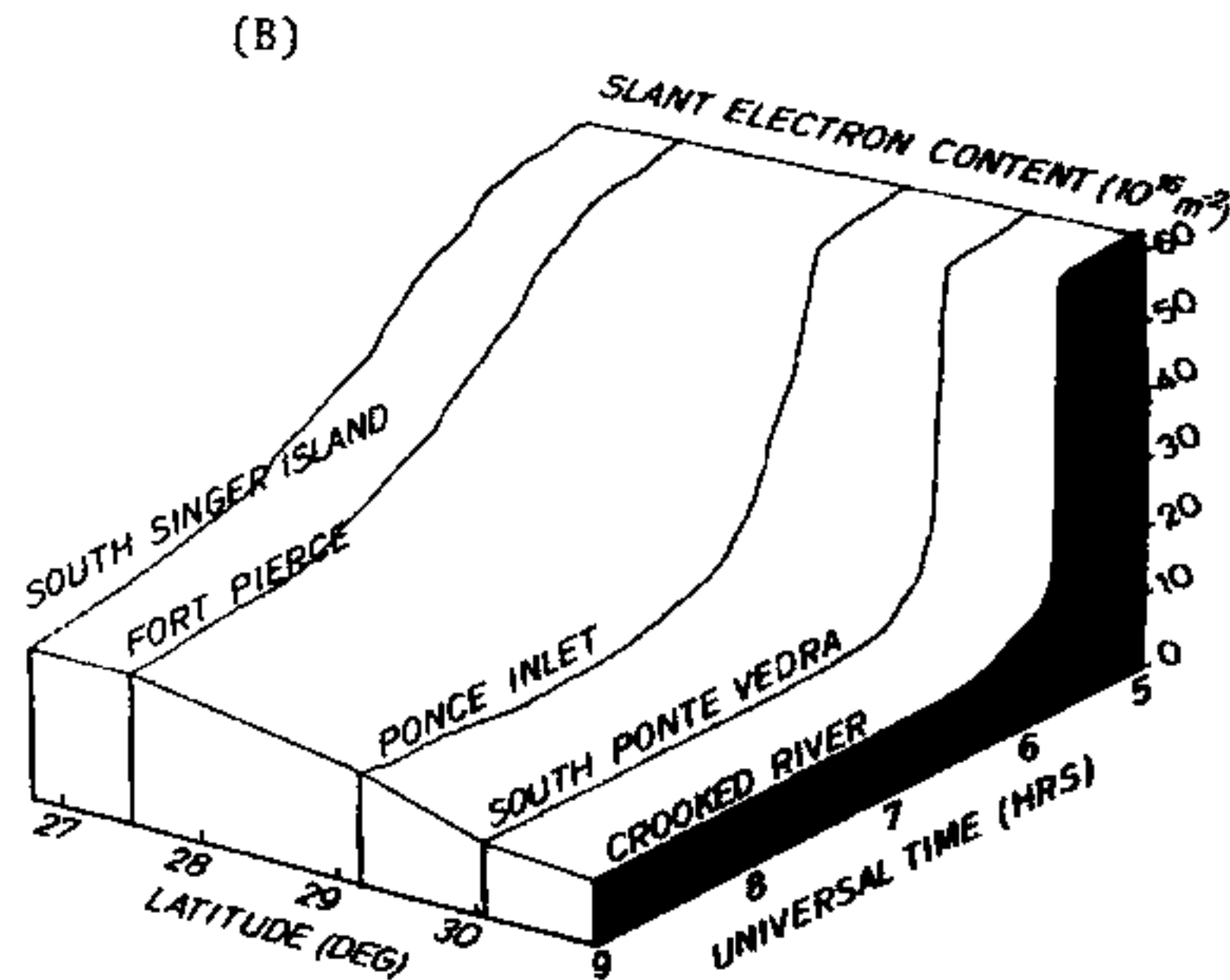

(C)

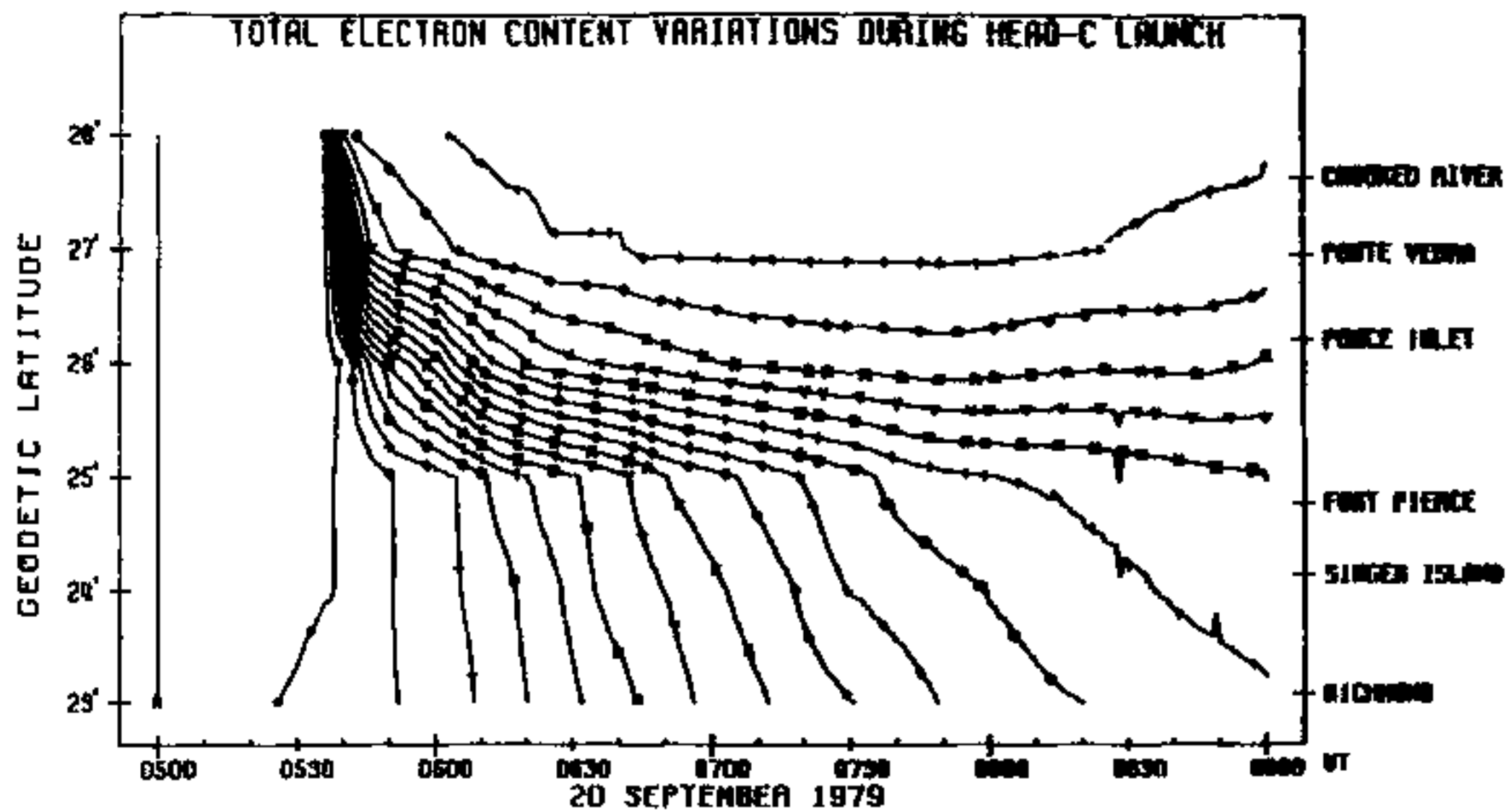

THE LAGOPEDO EXPERIMENTS

Morris B. Pongratz, Gordon M. Smith, Henry G. Horak, David J. Simons,
C. Dexter Sutherland, John H. Wolcott, and John Zinn

The Lagopedo ionospheric depletion experiments conducted with sounding rockets launched from the DoE launch facility in Kauai, Hawaii, represent unique experimental benchmarks for testing the predictions of theoretical codes designed to calculate the ionospheric effects of heavy lift launch vehicles' exhaust gases. The experiments were conceived and designed at the DoE's Los Alamos Scientific Laboratory. The rockets were fabricated and launched by the DoE's Sandia Laboratories.

The reactive gases were generated by detonating an explosive which was carried to F-region altitudes as the daughter component of a mother-daughter rocket payload configuration. The mother component of the payload carried in situ and total electron content diagnostic packages. To date, the Lagopedo experiments have provided the only existent in situ diagnostics of an artificial ionospheric depletion. Ground-based observations included imaging optics and photometry, ionosonde and total electron content diagnostics, and radar measurements.

The recombination of the O^+ ion leads to atomic oxygen in various excited states. The resulting line emissions provide a means of remotely measuring the population of these excited states. This measurement can then be compared with theoretical calculations of the population of excited states. For this particular example we have determined the number of excited atoms along a line-of-sight from the optical ground station. A similar integral has been determined from the theoretical calculations so that a direct comparison is possible.

The $O(^1D)$ excited state of oxygen decays by emitting photons at 630.0 nm. This excited state has a lifetime of 110 s. The measured radiance at 630.0-nm deduced from photographic data and photometers was converted to integrated column density of excited states $[O(^1D)]$ by taking the inverse of this time as a rate constant, that is we assumed

$$I(\text{photons/cm}^2) = \frac{N[O(^1D)]}{\tau},$$

with $\tau = 110$ s and $N[O(^1D)]$ as the column density of $O(^1D)$.

For purposes of comparison, we have treated two quantities from the data and the theoretical calculation, (1) the maximum column density and (2) the integral of the column density over the observations area, which is equal to the total number of $O(^1D)$. Both of these quantities have similar qualitative behavior for the experimental and the theoretical results.

For Lagopedo II, both experimentally determined quantities increase with a time scale on the order of 100 s and then very slowly decay. The maximum column density falls off with an e-folding time on the order of 1000 s while the integrated column density (total number of excited states) falls off with an e-folding time on the order of 1200 s.

The theoretical determination of the same quantities based upon the two-dimensional model shows a somewhat different behavior. The maximum column density agrees in order of magnitude quantitatively but has a very slow rise time when compared to the empirical results. It has a very broad peak at around 300 s and shows only a small decrease by as late as 600 s. The e-folding time of the fall-off is approximately 2000 s. The total number of $O(^1D)$ increases very slowly out to 500 s and then remains constant over the time of the computer simulation.

The very slow time variation in the theoretical calculation seems due to the persistence of the ice cloud and its slow sublimation. Better quantitative and qualitative consistency can be achieved by fairly simple changes in the sublimation model.

ICE FORMATION DURING LAGOPEDO UNO

Charles F. Lebeda, EG&G, Los Alamos, NM;

Morris B. Pongratz, Los Alamos Scientific Laboratory, Los Alamos, NM

Hydrocarbon combustion products such as CO_2 and H_2O , as emitted from rocket engines, are known to deplete the electron and ion content of the ionosphere. Operation Lagopedo was executed to determine the behavior of these reactive species in the ionosphere under controlled conditions. Operation Lagopedo consisted of two rocket-borne injections of CO_2 and H_2O into the F-2 region of the ionosphere near Hawaii during September of 1977. The first of these injections occurred in sunlight, the second did not. Photographic images of the first injection yield unique experimental information concerning the effectiveness of H_2O in depleting the ionosphere. The expanding water vapor froze and was not able to react with the local electrons and ions as ice. Subsequent sublimation of the ice particles to vapor made the H_2O capable of reacting with the ambient electrons and ions. Determination of the amount of the water that froze and the duration that it remained frozen defines temporally how much of the water can react. We present the results of the analysis of the images of the scattered sunlight that we used to determine the amount of water that froze and the decay time for the ice.

The data used for the early-time analysis consisted of four images of light scattered from the ice particles. These images were recorded on Kodak EKIR film (500 to 900 nm), and covered a time span from two to fifteen seconds after event time. We assumed that all the particles in a column corresponding to a particular line of sight (or a point in the image) were spherical Mie scatterers of identical radius. From the exposures in each of the three independent color bands at each such point in the image, and the properties of Mie scatterers, we were able to determine the radius and number of the scatterers. The particle radius and number in each column were converted to masses of ice. Two-dimensional integration gave total ice mass in the cloud. The maximum amount of ice determined from this analysis was 4.24 kg, which is approximately ten percent of the estimated mass of the water released (45 kg). A fit of total ice mass vs time to a decaying exponential gave a time constant of 10 seconds. The particle radius averaged over the cloud was about 0.42 μm , independent of time. There was unexpected structure in the cloud appearing as a fan expanding upward from the center of the cloud.

We next assumed that the ice density at a point in space was proportional to the water vapor density there. We then fit spatial profiles of ice mass density to forms like $\exp(-|x|^2/R^2)$. We found that this form, based on a Maxwellian velocity distribution, best fit the early data as opposed to forms that had a peak in the velocity distribution at nonzero velocities. The fit of R vs time for the first three frames was linear with a slope of 2.6 km/s. This fit was good through 6.2 seconds. The next frame (15 s) was inconsistent with this form. Thus, we conclude that the vapor cloud expanded freely prior to 15 seconds and thereafter expanded by another mechanism.

To determine the behavior of the ice cloud at later times we analyzed images recorded with intensified cameras filtered to record light in narrow bands at 455.4 and 772.0 nm. A particle size analysis could not be performed on these data because there was not enough information. However, the light output in these two bands could be predicted from the computed properties of the scatterers obtained from the color film. The decay constant predicted for the total light from the cloud in the 455.4-nm band was 8.6 seconds while the intensified camera gave a decay constant of 13.7 seconds. The predicted and measured peak amplitudes agreed to approximately 50%. However, the intensified camera total light peaked approximately 23 seconds after the color pre-

diction. In the 772.0-nm band, the color prediction gave a time constant of 8.3 seconds; the intensified camera data gave a time constant of 35.4 seconds. The color prediction of total light was approximately 100 times as great as that measured by the intensified camera. We are unable to explain this discrepancy at this time.

In summary, we found that a very small fraction of the water vapor froze (~ ten percent) and that once frozen, it decayed with a 10- to 15-second time constant.

THEORETICAL INVESTIGATIONS OF IONOSPHERIC MODIFICATIONS PRODUCED BY
ROCKET EXHAUST

Paul A. Bernhardt

Radioscience Laboratory - Stanford University
Stanford, California 94305

Placing a Solar Power Satellite in orbit will probably require the firing of rocket engines in the ionospheric F-layer. These engine burns will cause a temporary reduction in the ionospheric plasma concentration. The plasma reduction process involves chemical reactions between the exhaust and the monoatomic ions in the atmosphere above 100 km altitude. Polyatomic neutral species, such as H_2O , CO_2 , H_2 and N_2 , are common constituents of rocket exhaust. By reaction with the O^+ ion in the F-layer, these neutrals are converted into polyatomic ions such as H_2O^+ , O_2^+ , OH^+ and NO^+ . These ions rapidly recombine with the free electrons in the ionosphere. The net effect of the chemical reaction is to convert as much as 95% of the local plasma into neutral species. The rates for reaction between the O^+ ion and the exhaust molecules can be 1000 times larger than the rates for reaction with the normal constituents of the atmosphere.

In order to realistically model the ionospheric modification process, one must not only consider the chemical coupling between the injected neutrals and the ambient plasma, but one must also consider; 1) Neutral gas expansion including the effects of condensation, collisional heating, diffusion in a reactive environment and transport via winds, 2) Plasma dynamics including interhemispherical flow along magnetic field lines and transport due to electric fields and neutral winds, 3) Thermal processes describing the changes on the ion and electron temperatures, 4) Infrared, visible and ultraviolet radiation from excited neutral species and 5) Instabilities generated by internal electric fields. Models have been constructed which incorporate one or more of each of these mechanisms listed above. However, no one numerical model of the modified ionosphere contains all of these items.

Simulation of expansion from rocket nozzles predicts a variety of changes in the exhaust vapors. Immediately after release, the pressure and temperature of the plume rapidly drops. At some point, condensation sets in, causing as much as 30% of the exhaust to form into sub-micron ice clusters. The exhaust which remains as vapor undergoes molecular collisions with the ambient

atmosphere and is heated to the background temperature. The vapors then continue to expand diffusively. The diffusive expansion of the exhaust vapors, along with the transport via neutral winds, controls the spreading of the reactive exhaust vapors, and, consequently, controls the size and location of the ionospheric "hole".

The ionosphere recovers by photoionization of the neutrals and by plasma transport into the modified region. External electric fields can transport plasma across magnetic field lines. The depleted region can be filled in by plasma flowing along geomagnetic field lines. This is the only recovery mechanism during the night. When the ionosphere is sunlit, the sun's extreme ultraviolet rays directly re-ionize the modified region. Consequently, the ionospheric recovery is slower at night than during the daytime.

The reduction in plasma concentration affects the thermal properties of the upper atmosphere. In the modified region, the cooling of electrons onto ions is reduced. This causes an increase (by as much as 2000 K) in the electron temperature. This temperature change influences the plasma transport and the chemical reaction rates.

Chemical reactions resulting from an exhaust release produces excited molecules. These molecules can radiate airglow at IR, visible, and UV wavelengths. The intensity of this airglow can be 20 K Rayleighs or greater.

The plasma gradients in the ionospheric hole may induce internal electric fields. These fields can cause the region to become unstable, breaking up into irregularities. These irregularities are most likely to form for releases near the earth's magnetic equator. Here, where the geomagnetic field lines are horizontal, the earth's gravity produces naturally occurring plasma irregularities. Depending on the amount and the geometry of an exhaust release, instabilities may be triggered or damped by the vapor injection.

Radiowave propagation will be altered in the disturbed ionosphere. Propagation via refraction in the bottomside ionosphere can suffer the effects of focusing, defocusing or multipath fading in the vicinity of an ionospheric hole. Communication between satellite and ground-based locations can be degraded by artificially stimulated plasma irregularities. Theoretical studies are necessary to predict the changes in radiowave propagation in an ionosphere modified by the injection of rocket exhaust.

EFFECTS OF ROCKET EXHAUST PRODUCTS IN THE THERMOSPHERE AND IONOSPHERE
 John Zinn, C. Dexter Sutherland, Sidney N. Stone, and Lewis M. Duncan
 Los Alamos Scientific Laboratory, Los Alamos, New Mexico
 Richard Behnke
 Arecibo Observatory, Arecibo, Puerto Rico

This paper reviews the current state of our understanding of the problem of ionospheric F-layer depletions produced by chemical effects of the exhaust gases from large rockets, with particular emphasis on the "Heavy Lift Launch Vehicles" (HLLV) proposed for use in the construction of solar power satellites. The currently planned HLLV flight profile calls for main second-stage propulsion at apogee. The second-stage engines deposit 9×10^{31} H_2 molecules between 74 and 124 km. Model computations show that they diffuse gradually into the ionospheric F region (i.e., above 200-km altitude), where they lead to weak but widespread and persistent depletions of ionization and continuous production of H atoms. The orbit-circularization burn deposits 9×10^{29} exhaust molecules at about 480-km altitude. These react rapidly with the F2 region O^+ ions, leading to a substantial (factor of three) reduction in plasma density, which extends over a 1000- by 2000-km region and persists for four to five hours.

Present understanding of ionospheric F-layer depletions caused by exhaust products from large rockets began with the observations by M. Mendillo et al.¹ of an abrupt decrease in vertical electron column density along the trajectory of the launch of Skylab I May 14, 1973.

The ionospheric electron column density was observed to be reduced by 50% or more over a period commencing within ten minutes after the launch and persisting for about four hours. The effect was attributed to the chemical reaction of rocket exhaust molecules, primarily H_2O and H_2 , with O^+ , the dominant F2 layer ion. The main reactions are

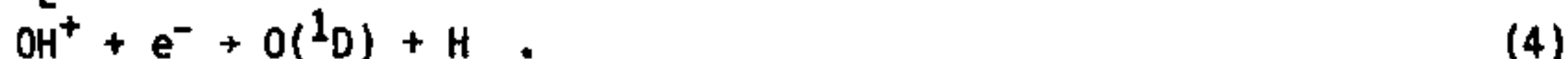

The recombination reactions (3) and (4) are about 10^5 times faster than the direct recombination of O^+ with electrons, i.e.,



Moreover, the charge transfer reactions (1) and (2) are some 10^3 times faster than the normally occurring F-layer charge transfer reactions, i.e.



which regulate the normal ambient levels of ionization.

The severity, geographic extent, and duration of the F-layer depletions produced by the exhaust product molecules are determined by a combination of interacting processes, including chemistry, diffusion, gravitational settling, and advection by prevailing winds. We are studying these combined processes with the aid of an elaborate two-dimensional computer model, which has proven capable of reproducing the experimental data quite well.² According to the model, the apparent four-hour duration of the Skylab ionospheric hole was due to winds that moved it out of the instrumented lines-of-sight. The actual lifetime of the hole was probably 16 hours.

In September 1979, a large organized effort was mounted to make ionospheric measurements and optical airglow measurements in conjunction with the launch of satellite HEAO-C from Cape Canaveral. The Atlas-Centaur-powered flight trajectory passed through the F2 layer, and was predicted³ to result in a significant ionospheric depletion. Our own participation consisted of (1) furnishing detailed computer-model predictions, (2) performing incoherent-scatter radar measurements from Arecibo, and (3) optical airglow measurements from the Florida peninsula. We will describe the experimental results and compare these results with prelaunch and post-launch model computations.

A set of computed electron-density profiles representing the ionosphere one hour after the HEAO-C launch is shown in Fig. 1. Figure 2 is an image-enhanced photograph of the HEAO-C airglow, as seen from Melbourne, Florida.

For the case of an HLLV launch, where the second-stage burn is confined to altitudes below 124 km, the chemistry problem is quite different. Addition of H₂O and H₂ molecules at those altitudes does not appreciably accelerate ion/electron recombination. However, the molecules survive at those altitudes for weeks, and gradually diffuse into the F-layer where they lead to weak but widespread and persistent depletions of ionization. The calculated depletion amounts to about 10% in the daytime (24 hours after a single launch) and 30% at night. Large quantities of atomic H are produced at a rate that may be sufficient to substantially increase the density of the upper thermosphere (above 1000 km).

A potentially serious problem is the formation of high-altitude (70 to 100 km) condensed water clouds. Since the water survives for weeks at these altitudes, it can accumulate over the course of many launches.

The HLLV circularization maneuvers, which occur at the apogee near 480-km altitude, do produce F-layer depletions similar to those observed with Skylab or HEAO-C. The calculated depletion extends over a region 1000 by 2000 km and persists for four hours. The peak electron density is reduced to one-third of its normal value.

REFERENCES

1. M. Mendillo, G. S. Hawkins, and J. A. Klobuchar, "A Sudden Vanishing of the Ionospheric F-Region due to the Launch of Skylab," *J. Geophys. Res.* 80, 2217-2228 (1975).
2. J. Zinn and C. D. Sutherland, "Effects of Rocket Exhaust Products in the Thermosphere and Ionosphere," Los Alamos Scientific Laboratory report LA-8233-MS (1980).
3. M. Mendillo, J. Baumgardner, and J. A. Klobuchar, "Opportunity to Observe a Large-Scale Hole in the Ionosphere," *EOS* 60, 513 (July 1979).

Computed contours of electron density across HEAO-C launch trajectory 1500-km downrange at 1 hr after launch. Also shown are projections of instrumental ray paths for the two polarimeters on Bermuda.

E CONTOUR, HOURS OF RUN = 1.00, HOUR OF DAY = 2.5

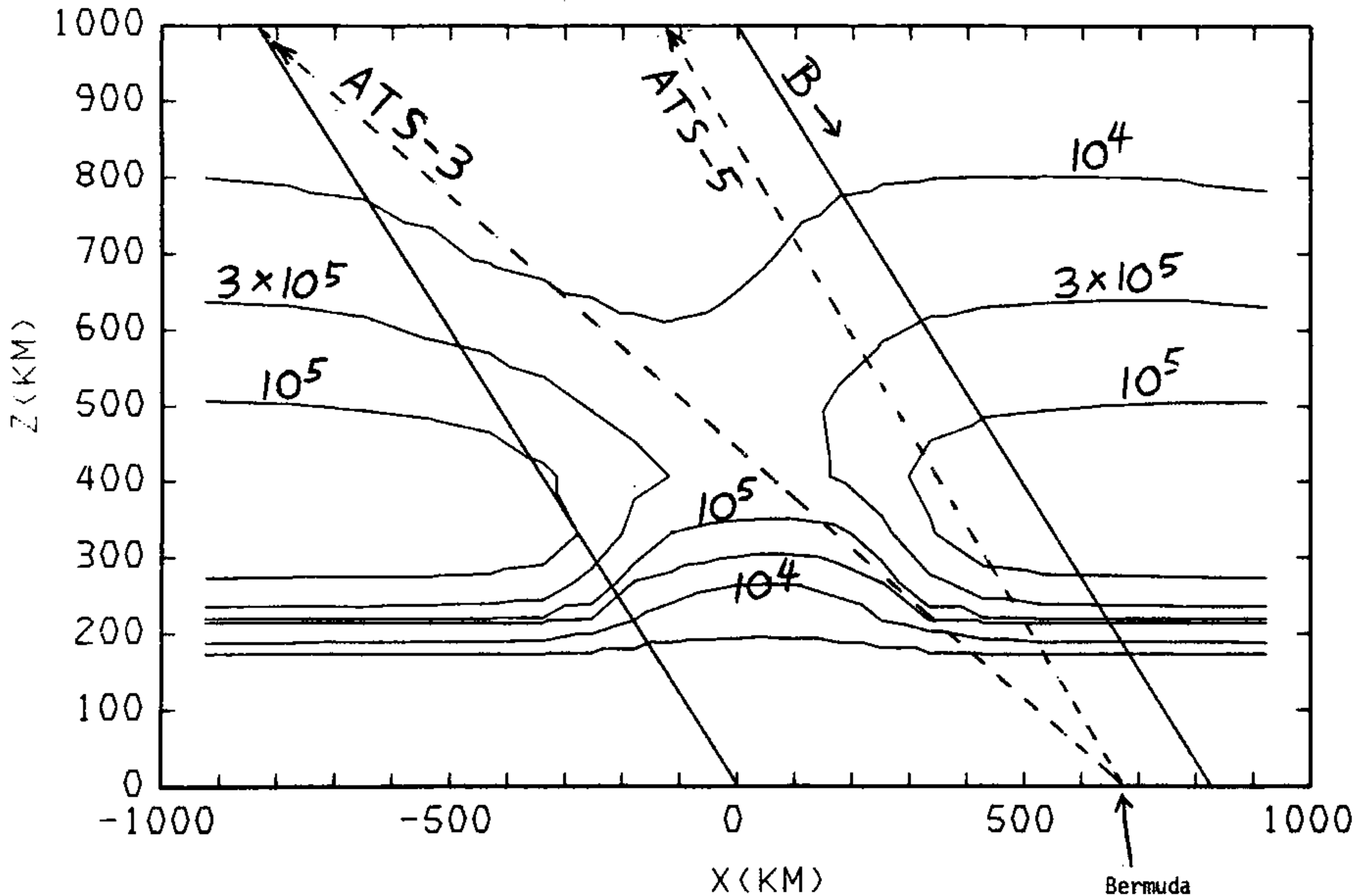

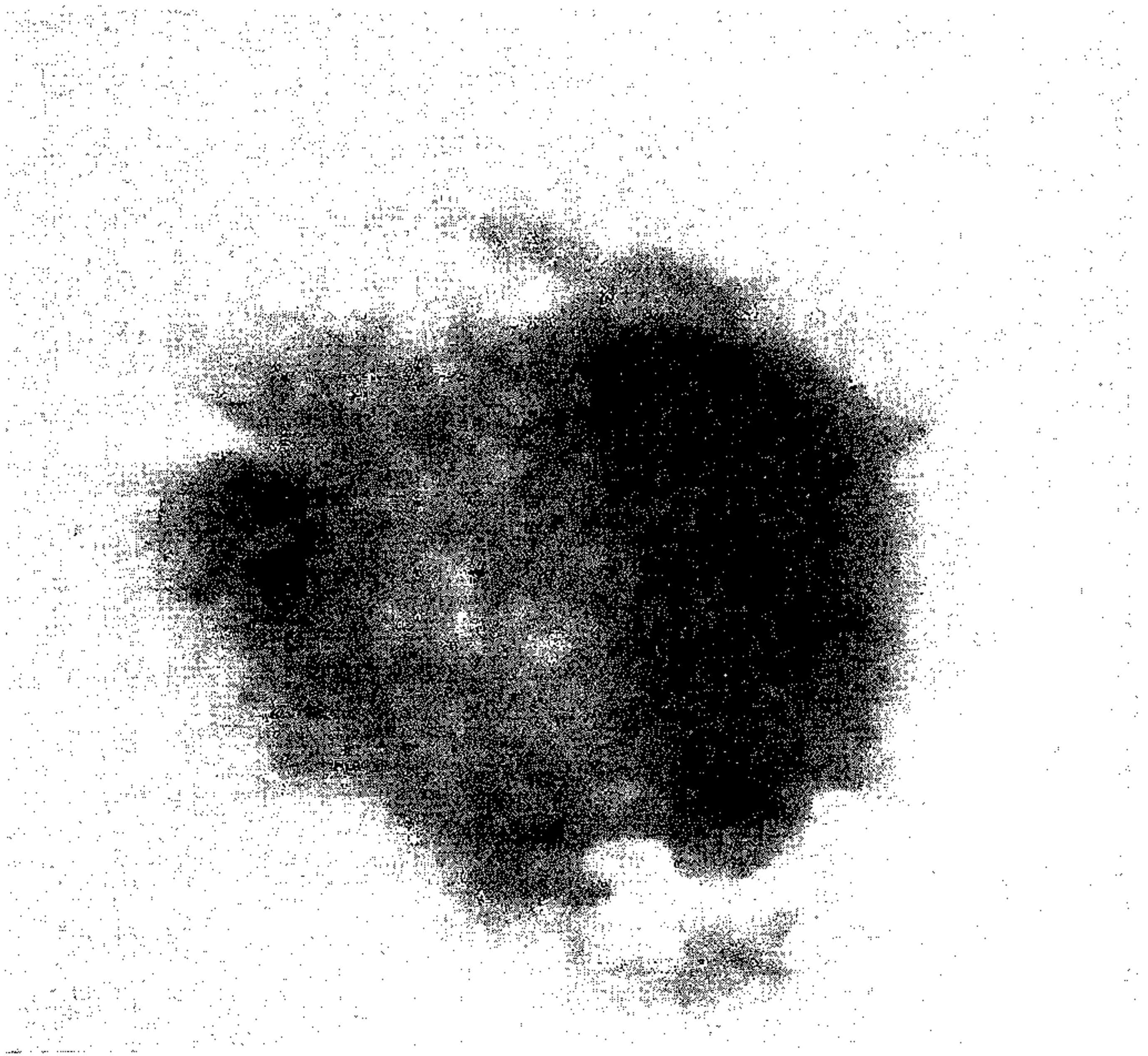

Figure 2

Computer-processed photographic image of 6300-Å airglow from HEAO-C launch at 9 minutes as seen from Malabar, Florida. The background has been subtracted by the computer. The apparent north-south width in this photo is 450 km.

PLASMASPHERIC AND MAGNETOSPHERIC EFFECTS OF POTV AND COTV EFFLUENTS

Y. T. Chiu

Space Sciences Laboratory - The Aerospace Corporation
P. O. Box 92957 - Los Angeles, California 90009

This briefing deals with the current (FY80) progress in quantitative assessment of rocket engine exhaust effects of the Satellite Power System (SPS) in the magnetosphere and ionosphere. We shall consider argon ion engine effects for the cargo orbit transfer vehicles (COTV) and the LO_2/LH_2 chemical engine effects of the personnel orbit transfer vehicles (POTV). Both of these vehicles will make a number of trips between low earth orbit (LEO) and geosynchronous orbit (GEO) during the construction phase of each SPS. The long-term accumulative effects (if any) are presently unknown, and they depend on factors such as the number and scheduling of SPS spacecraft construction. Our quantitative assessment for FY80 is limited to the short term fate of the orbit transfer vehicle exhaust for the construction of a single SPS.

Present knowledge of the effects of ion engine exhaust from the COTV has been reviewed in FY79. Dr. Don Rote's introductory remarks have touched upon them. The DOE/NASA baseline concept of July 1978 calls for use of argon ion engines of 3.5 keV beam energy, which works out to be 130 km/sec in beam speed for the argon ions. This plasma exhaust cloud is thus moving across the magnetic field at $\sim 1/10$ of the Alfvén speed in the plasmasphere, as depicted in Fig. 1. The plasmasphere and ionosphere feels the presence of this plasma cloud because it causes a pair of Alfvén waves (shocks) to travel along the magnetic field lines down to the ionosphere, in much the same manner as the bow waves produced by a ship. Since these waves set the magnetospheric plasma in motion and since they also drive a conduction current in the ionosphere, the momentum of the argon beam is transferred to the magnetospheric and ionospheric plasma. This mechanism allows the major part of the beam momentum to be soaked up by the magnetospheric and ionospheric plasma, resulting not necessarily in a uniformly cold argon plasma, but in one with some hot argon plasma components trapped in the magnetic field due to pitch angle scattering. These hot components act much like an argon ring current. Numerical models of this process for realistic plasmaspheres have been constructed in FY80 and their results have essentially borne out these expectations. The essential point to be recognized is that the momentum transfer process takes place via the Alfvén wave electric field, which moves through the plasmasphere at the Alfvén speed (~ 10 times the beam speed). Numerical calculations verify that the momentum transfer process has a time constant of $\ll 20$ sec., so the argon beam has a length of ≈ 2000 km. This mechanism is not new and has been considered for various processes by Drell, Foley and Ruderman (1965), by Zinn, Hoerlin and Petschek (1966), by Scholer (1970), and more recently by Kivelson and

Southwood (1979, private communications) for the Jupiter-Io momentum transfer problem.

The main effect of the neutral exhaust cloud is that it acts as an artificial source that can charge-exchange with ring-current ions, thereby reducing the lifetime of these energetic particles and modifying auroral activity. Natural charge-exchange lifetimes for ring current ions are $\sim 10^5$ sec, as can be seen from the duration of the recovery phase of a geomagnetic storm. If the ring-current particle lifetimes are significantly shortened by charge exchange interaction with the neutral cloud, auroral activity would be significantly reduced by the following sequence of effects: (a) charge-exchange reaction converts an energetic charged particle into an energetic neutral which immediately escapes geomagnetic confinement; (b) ring current precipitation and trapped fluxes are reduced, leading to (c) reduction of strength and duration of geomagnetic storms and ionospheric disturbances.

According to the DOE/NASA baseline concept of July 1978, the POTV will have ignition weight at LEO of 890 tons, of which the propellants LO_2/LH_2 comprise 830 tons. The major part of the chemical exhaust, in the form of H_2O initially and in the form of dissociated H and O neutrals, will eventually escape the earth's gravitational field except for some 140 tons emitted by particular "burns" of the vehicle (private communication by Dr. C. Park of NASA/Ames who constructed a typical scenario of POTV burns). These 140 tons of H and O atoms ($\sim 2.4 \times 10^{31}$ neutral atoms) form a spherical shell of charge exchange centers between 3000 km altitude and 30,000 km altitude, precisely in the vicinities of the ring current and the radiation belts. The trapped neutral cloud (gravity vs. centrifugal force) will have a very long lifetime because its density is not sufficient to change the collisionless character of the medium. Thus, aside from prompt and transient effects of charge exchange caused by the neutral exhaust cloud immediately after release, about 1/5 of the propellants of each POTV flight would be trapped in orbits centered at about 15,000 km altitude. The accumulative effects of this "neutral" belt is not presently known and will be investigated in our research program.

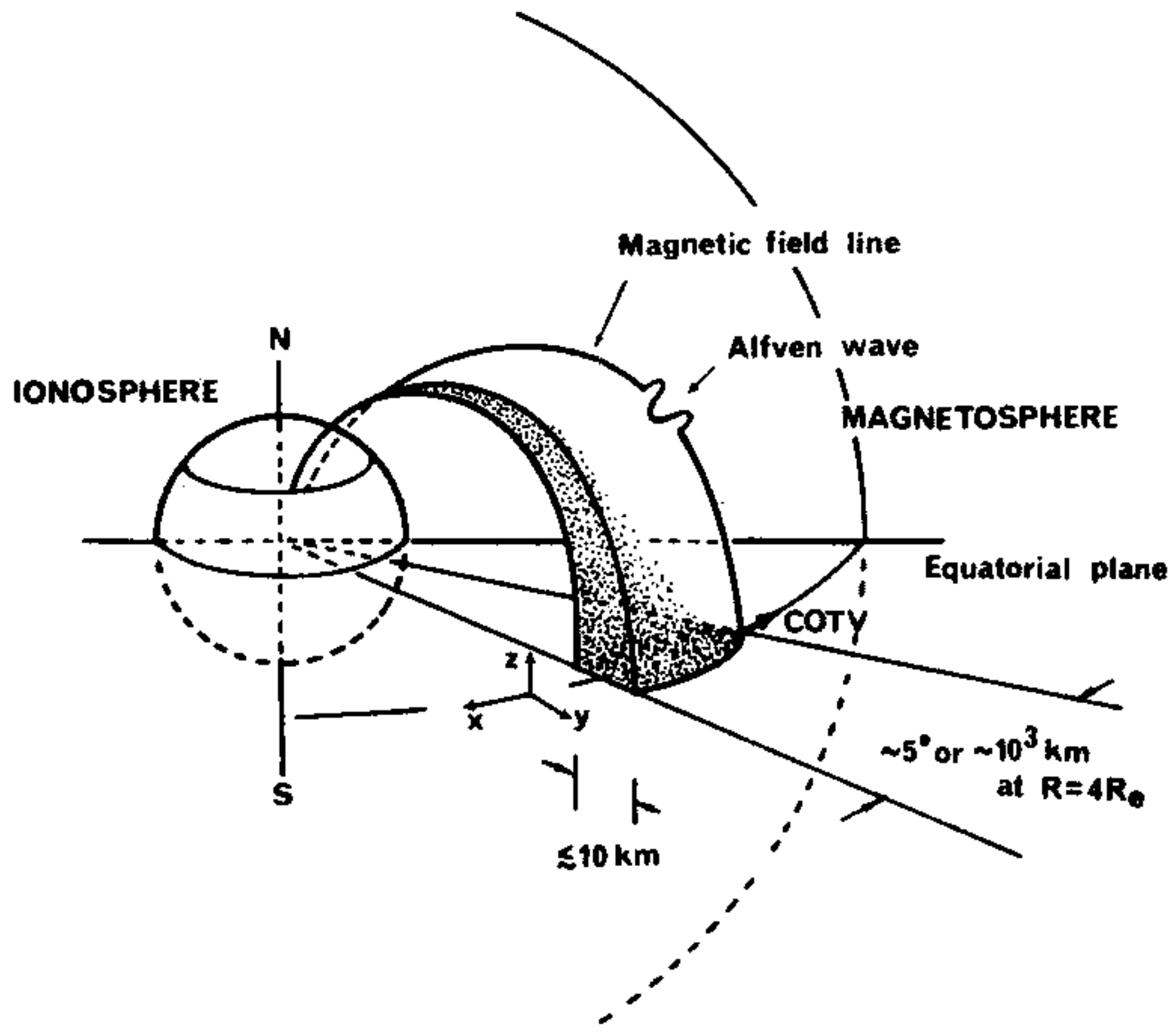

Figure 1

DISPOSITION OF SPS ELECTRIC THRUSTER EXHAUST

D. H. HOLZE AND H. B. LIEMOHN

BOEING AEROSPACE COMPANY

SEATTLE, WA 98124

PRESENTED AT THE

DOE/NASA

SATELLITE POWER SYSTEM PROGRAM REVIEW

APRIL 22-25, 1980

UNIVERSITY OF NEBRASKA - LINCOLN

The transit of large Space Power System vehicles from low earth orbit to geosynchronous altitude requires electric thruster propulsion that will deposit great quantities of ions into the magnetosphere. Interactions between this foreign material and the natural environment needs study in order to assess possible modifications of communication paths, auroral illumination levels, and radiation dosage to spacecraft. Methodology has been developed for determining the temporal and spatial distribution of the exhaust ions (probably A^+) from the Orbit Transfer Vehicles (OTVs). The analysis takes account of large angles between the thrust vector and the OTV velocity (nearly orthogonal) which are required to reach the equatorial plane. Consequently, the dense plume of thruster ions is seldom normal to the earth's field, as frequently suggested. After the initial expansion, individual ions follow (Van Allen type) trapped trajectories in the geomagnetic field. The principal loss mechanism is charge exchange with natural oxygen and hydrogen. Preliminary quantitative estimates indicate only a fraction of the exhaust ions re-enter the atmosphere, most escape.

DISPOSITION OF SPS ELECTRIC THRUSTER EXHAUST

D. H. Holze and H. B. Liemohn
Boeing Aerospace Company, Seattle, Washington

A methodology is presented which will allow the calculation of the total quantity of thruster argon precipitated into the earth's atmosphere. Our calculations conclude that the ions transfer to single particle orbits in tens of kilometers from the thrusters¹ and that the dominant ion loss mechanism is charge exchange with thermospheric neutrals. The methodology is presented in more detail elsewhere.²

Figure 1 defines the geometry for an OTV in a circular transfer orbit with inclination i (defined by $i = \sin^{-1} (\sin \lambda / \sin \psi)$) and velocity v . Because the inclination must be reduced to zero as the OTV approaches GEO, the thrust is not in general antiparallel to the velocity. For a dipole field it was found that the pitch angle between the thrust vector and the local geomagnetic field direction is

$$\alpha = \cos^{-1} \left[\sin (\beta - \gamma) \cos \lambda / \sqrt{3 \sin^2 \lambda + 1} \right] \quad (1)$$

where $\gamma = \tan^{-1} (v_\lambda / v_\phi) \quad (2)$

and $\beta = \tan^{-1} (4.5 \times 10^{-7} r^{3/2} \cos \psi). \quad (3)$

(This expression which optimizes payload to GEO gives a maximum β value of 76° for $r_{GEO} = 42,000$ km.)

The thruster plasma is sufficiently dense in the vicinity of its exit plane to generate its own currents that block out the geomagnetic field. As the beam and thermal plasmas expand, however, the geomagnetic field eventually takes control of the individual particles. As a first approximation, it will be assumed that most ions transfer to single particle orbits by the time the plasma dynamic pressure drops to one-tenth of the magnetic field pressure. The worst case occurs at GEO where the 920 OTV thrusters (120 cm, 1.5 kV) produce a plasma plume extending 670 km downstream. At LEO, single particle behavior commences 1.4 km downstream from each corner of the OTV.

Once thruster ions are trapped in the geomagnetic field they follow well-known orbits as pictured in Figure 2. It was found that the number density of thruster argon ions in the dipole shell between latitudes λ_1 and λ_2 is

$$n_A = \frac{1.11 \times 10^{24} \Delta t |e| B_e}{T_{||} r_e^2 m v \sin \alpha} \left[\int_{\lambda_1}^{\lambda_2} \frac{\cos^{10} \lambda d \lambda}{\cos \theta_s \sqrt{1 + 3 \sin^2 \lambda}} \right]^{-1} \quad (4)$$

where the orbiting time Δt is

$$\Delta t = \frac{2r_e}{v} \int_{\lambda_1}^{\lambda_2} \frac{\cos \lambda \sqrt{1 + 3 \sin^2 \lambda} d \lambda}{\left[1 - \frac{\cos^6 \lambda_m \sqrt{1 + 3 \sin^2 \lambda}}{\cos^6 \lambda \sqrt{1 + 3 \sin^2 \lambda_m}} \right]^{1/2}} \quad (5)$$

The bounce period, $T_{||}$, is found from Eq. (5) by letting λ_2 be the mirror latitude λ_m and setting $\lambda_1 = 0$. In these equations e is the electron charge, B_e is the equatorial field intensity at r_e , m and v are the ion mass and speed and the angle θ_s is defined in Figure 2.

Next consider the fraction of these trapped ions which are precipitated into the earth's atmosphere. As noted earlier it is assumed that the dominant loss mechanism is charge exchange between the argon ions and thermospheric hydrogen. (Actually near LEO the charge exchanges are between the argon ions and oxygen, the major constituent in the upper atmosphere.) The average hydrogen density³ encountered by a trapped ion with mirror latitude λ_m along the field lines through r_e can be approximated by

$$\bar{n}_H = n_{eH}(r_e) \sec^6 \lambda_m \quad (6)$$

where n_{eH} is the equatorial density model.⁴ The average lifetime is

$$\bar{\tau}_A = 1/(\bar{n}_H \sigma v) \quad (7)$$

where σ is the charge exchange cross section. After an ion charge exchanges it will follow a straight line path away from the neutralization point since its speed is much higher than the escape velocity.

The situation is illustrated in Figure 3 for a special case. For each latitude, λ , the charge exchanged particles come out at a specific pitch angle, α , so that the escaping particles describe the surface of a cone of half angle α about the field direction. Only the edge of the cone nearest the earth's surface is depicted in Figure 3 for clarity.

For small λ essentially none of the argon atoms are precipitated. At the other latitudes the fraction of atoms precipitated is proportional to the portion of the conical surface subtended by the earth's surface. The number of atoms precipitated in a given $\Delta\lambda$ is also proportional to the average time spent in $\Delta\lambda$ (i.e., $\Delta t/T_H$), and the hydrogen density in $\Delta\lambda$.

Although this general procedure will allow total argon precipitation in the earth's atmosphere to be calculated for all SPS operations, detailed calculations have not yet been carried out. One hand calculation has been made for an OTV at 1.82 earth radii. It was found that only 16% of the argon precipitated in these orbits. At higher altitudes and smaller inclinations much less argon would intercept the atmosphere.

REFERENCES

- 1) Liemohn, H. B., D. H. Holze, W. M. Leavens, and R. L. Copeland, "Ion Thruster Plasma Dynamics Near High Voltage Surfaces on Spacecraft", paper to be published in AIAA book, Space Systems and Their Interaction with the Earth's Space Environment, 1980.
- 2) Holze, D. H., "Deposition of Solar Power Satellite Thruster Exhaust in Earth's Magnetosphere", Boeing Document D180-25574-1, October, 1979.
- 3) Liemohn, H. B., "Proton Lifetimes in the Van Allen Radiation Belts", Boeing (BSRL) Document D1-82-0117, June, 1961.
- 4) Johnson, F. S. and R. A. Fish, "The Telluric Hydrogen Corona", Astrophysics J. 131, 502-515, 1960.

OTV IN ORBIT -- THRUST DIRECTION

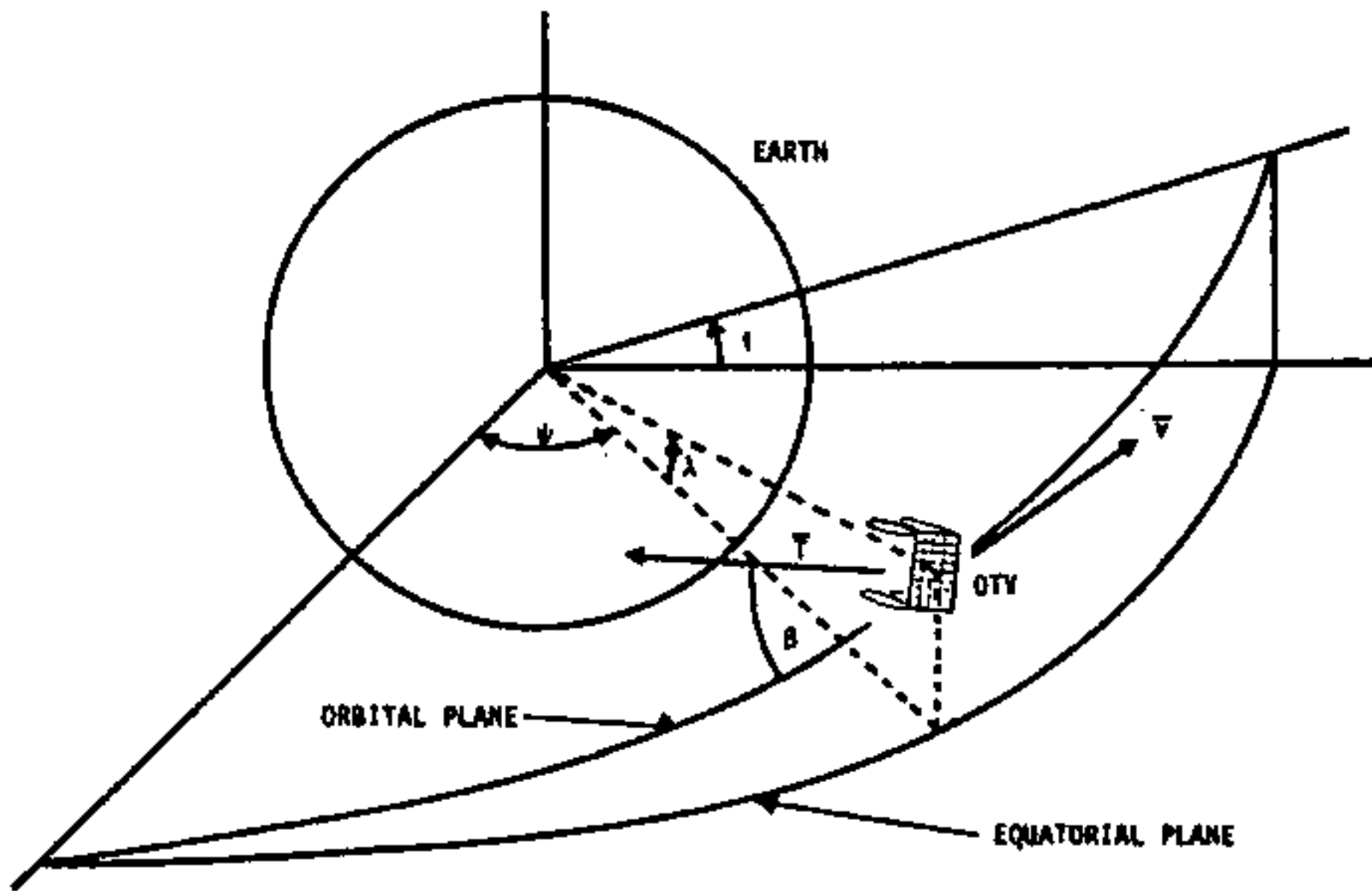

FIGURE 1. ORBITAL GEOMETRY AND THRUSTER EXHAUST FOR OTV

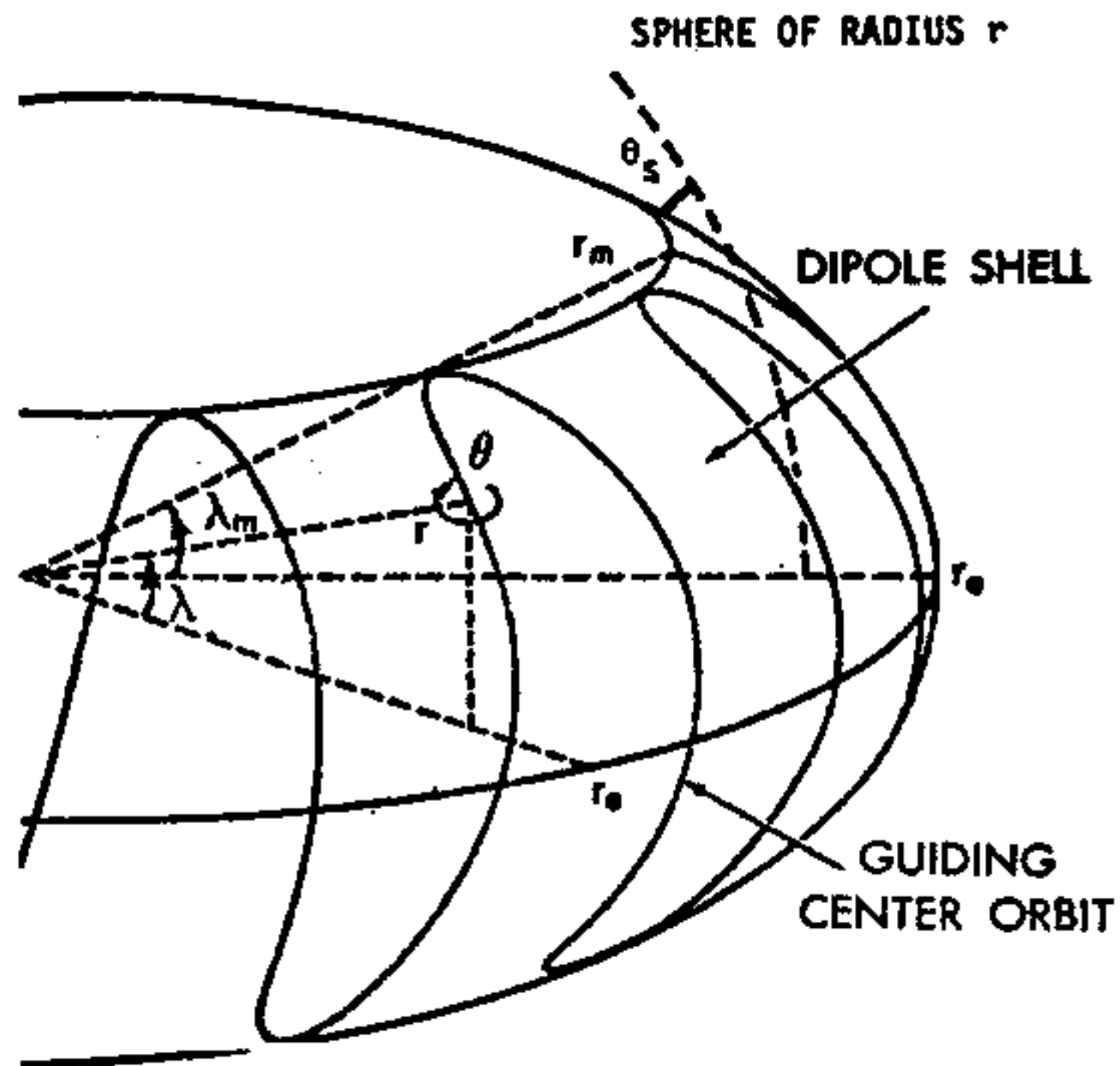

FIGURE 2. THE GUIDING CENTER ORBIT

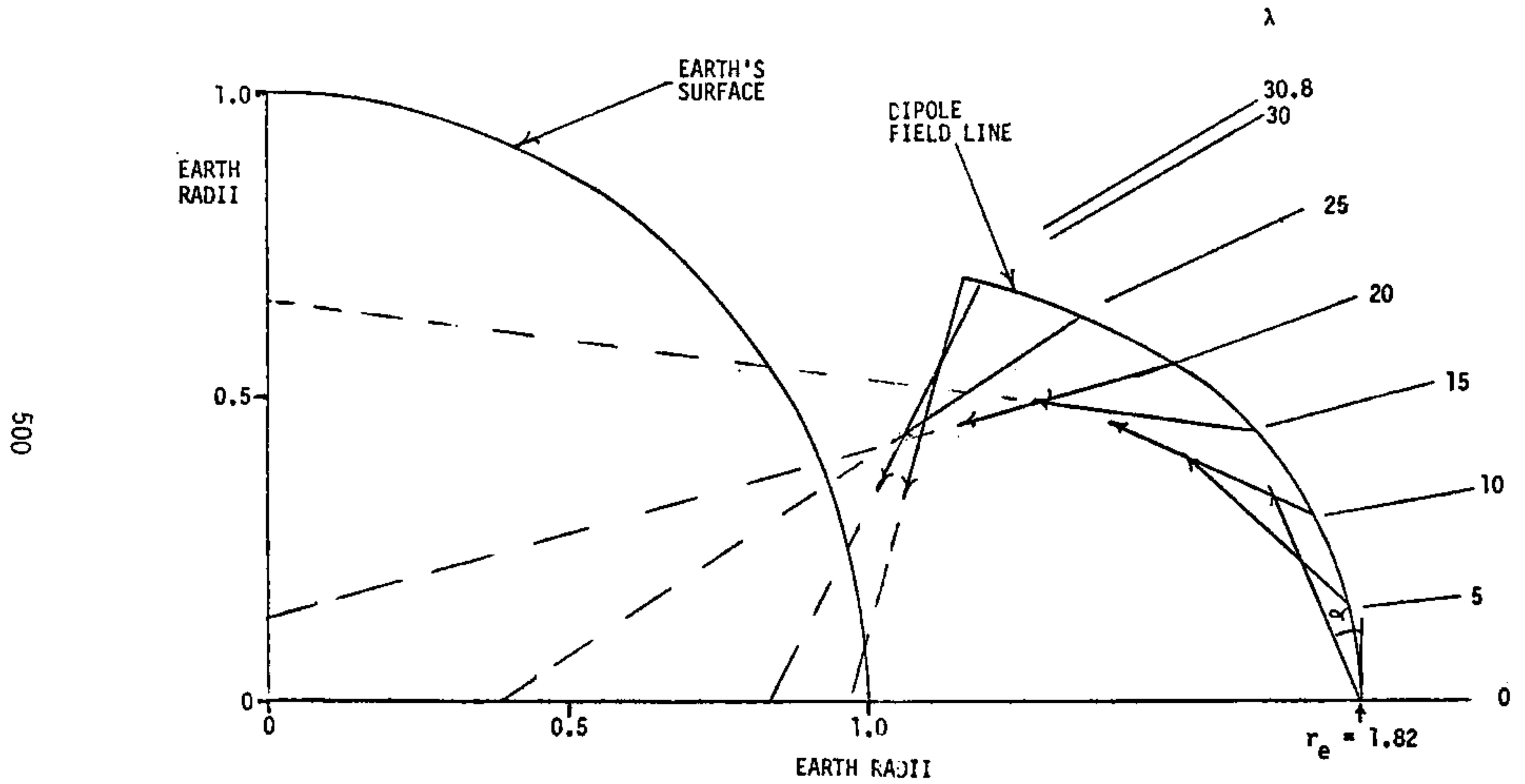

FIGURE 3. ARGON ATOM PRECIPITATION

EFFECTS OF ARGON ION INJECTIONS IN THE PLASMASPHERE

S. A. Curtis and J. M. Grebowsky
 Laboratory for Planetary Atmospheres
 NASA/Goddard Space Flight Center; Greenbelt, Maryland 20771

In lifting massive space power system payloads from low earth orbit to geosynchronous earth orbit, Cargo Orbit Transfer Vehicles (COTV) using ion propulsion will inject energetic beams of argon ions into the plasmasphere. The argon ion beams have a fast velocity $V_b \lesssim V_A$ the Alfvén velocity of the plasmasphere medium and $V_b \gg V_{th}$ the thermal velocity of the plasmasphere ions. The relationship of the beam velocity to these characteristic velocities as a function of radial distance in the plasmasphere is shown in Figure 1 for positions near the earth's equatorial plane. The Alfvén speeds are shown for the Chiu et al model¹ plasmasphere and the average and low Alfvén speeds are calculated from OGO-5 observations analyzed by Chen et al². As can be seen, the Chiu et al model gives an upper bound to the Alfvén speeds. The average OGO-5 Alfvén speeds give the best indication of the Alfvén speeds which are of the order of the beam speed throughout most of the plasmasphere whose outer boundary is between 4 and 6 earth radii (R_e). Hence $V_b \lesssim V_A$. The thermal speeds in Figure 1 are taken from the Chiu et al¹ model. In this case discrepancies between observations and the model are unimportant since $V_b \gg V_{th}$ always. The spread velocity of the beam perpendicular to its direction of propagation is $\Delta V_b \sim 0.4 V_b$. Thus the exhaust of the COTV's may be described as a fast, rapidly diverging ion beam. Due to these beam characteristics, the numerous potential plasma instabilities which could take energy from the beam and hence stop it are ineffective. This is due to the fact that the beam and background plasma parameters change sufficiently rapidly as not to allow amplification of instability generated waves to significant amplitudes³. Another beam stopping mechanism which models the fast ion beam as a slowly moving ion cloud⁴ with $V_b \ll V_{th}$ and $V_b \ll V_A$ is not applicable given the relationship of V_b to V_A and V_{th} shown in Figure 1. In addition, to this inconsistency the ion cloud model⁴ assumes the beam plasma can be regarded as infinitely conducting. This frozen field line concept is not applicable here since a realistic model of the beam plasma⁵ which accounts for both the initial plasma turbulence and that generated by the low amplitude plasma wave turbulence carried with the beam gives rapid diffusion times $\tau = \lambda_b^2 / D_{\perp}^*$ as shown in Figure 2. Note that λ_b is the beam Debye length and D_{\perp}^* the anomalous diffusion coefficient associated with the plasma turbulence. The currents resulting from the turbulence induced anomalous resistivity are insufficient to short out the polarization electric field. Despite the limitations on beam stopping mechanisms caused by the beam velocity characteristics and its finite conductivity, not all of the beam plasma escapes the plasmasphere. Since the polarization electric field imposed at the thruster to allow cross field propagation of the beam is nonuniform over the sheath of the beam, the plasma in this sheath is lost and deposited on local field lines. This beam sheath loss model⁵ results in a deposition of argon ions and hence energy in the plasmasphere which is much less than that in models which call for ion clouds or plasma instabilities to rapidly stop the beam. In Figure 3, a comparison is given of the cumulative fractional mass loss of an ion beam injected at $1.5 R_e$ for the ion cloud and the ion beam sheath loss process. The ion cloud process yields total deposition very rapidly whereas all but a few percent of the beam in the ion beam sheath loss process escapes. In Figure 4 the integrated difference of these two deposition models is shown for the construction of one SPS. The ion cloud process gives better than an order of magnitude greater energy and number density perturbation

to the plasmasphere. The difference is not only quantitative but is also qualitative: the energy spectra of the argon ions deposited in the plasmasphere are dissimilar. For the ion cloud process accompanied by a weaker plasma instability loss process the solid line in Figure 5 gives a qualitative indication of the energy spectra of the argon ions. In the ion cloud model, most of the energy of the argon ions is dissipated in producing ionospheric currents caused by the cloud's field line dragging. This process yields the low energy peak. The higher energy tail and peak just below the injection energy of ~ 5 keV would be produced by various instability processes. In contrast, the sheath loss model shown by the dotted line in Figure 5 results in the argon ions being deposited with energies near the injection energy.

The different beam stopping mechanism can produce very different environmental impacts. The sheath loss model predicts a large injection of energetic anisotropic argon ions which will drive plasma instabilities which may produce sufficient scintillation to impair radio communications with geosynchronous satellites⁶. The partial depletion by precipitation of the energetic ion belts surrounding the earth is also possible due to the pitch angle scattering caused by argon ion turbulence. Cold argon ions ($T \sim 1$ eV) would result in the sheath loss model only via the loss of energy by plasma instability mechanisms and electron coulomb scattering. Since during the energy degradation processes, argon ions will be lost by charge exchange and precipitation, the cold Ar^+ plasma from the sheath loss mechanism will be much less than from the ion cloud mechanism. The environmental effects due to cold Ar^+ would be greatly reduced in the sheath loss picture as well as those effects due to ionospheric currents.

Finally, we note that in searching for observational support for ion beam stopping, the observations must correspond closely to the ion beam parameters envisioned for the COTV's. Specifically, the V_b , ΔV_b and the initial beam density and direction must be close to those planned for the COTV thrusters³. Arguments that barium release observations or high altitude nuclear blasts give evidence supporting a given beam model are therefore not valid. A far better experimental test would be a Space Shuttle-born ion beam experiment. This could be a scaled down COTV ion thruster with power levels of about a kilowatt and a nozzle diameter of a few centimeters rather than a megawatt and a meter. The other beam parameters could be the same as for a COTV. The required power levels could be within the limits of the planned solar powered auxiliary 20kW orbiter integral solar array or the 6kW orbiter mounted array.

¹Chiu, Y. T., J. G. Luhmann, B. K. Ching and D. J. Bouchen, Jr., An Equilibrium model of Plasmaspheric Composition and Density, J. Geophys. Res., 84, 909, 1979.

²Chen, A. J., J. M. Grebowsky and K. Marubashi, Diurnal Variations of Thermal Plasma in the Plasmasphere, Planet. Space Sci., 24, 765, 1976.

³Curtis, S. A. and J. M. Grebowsky, Energetic Ion Beam Magnetosphere Injection and the Solar Power Satellite, J. Geophys. Res., in press, 1980.

⁴Chiu, Y. T., J. G. Luhmann, M. Schultz and J. M. Cornwall, Effects of Construction and Operation of a Satellite Power System Upon the Magnetosphere, Aerospace Report No. ATR-80 (7824)-1, 1 December 1979.

⁵Ichimaru, S., Basic Principles of Plasma Physics: A Statistical Approach, W. A. Benjamin, Inc. (Advanced Book Program) Reading, Mass., 1973.

⁶Curtis, S. A. and J. M. Grebowsky, Changes in the Terrestrial Atmosphere - Ionosphere-Magnetosphere System due to Ion Propulsion for Solar Power Satellite Placement, submitted to Space Solar Power Review, 1979.

FIGURE 1

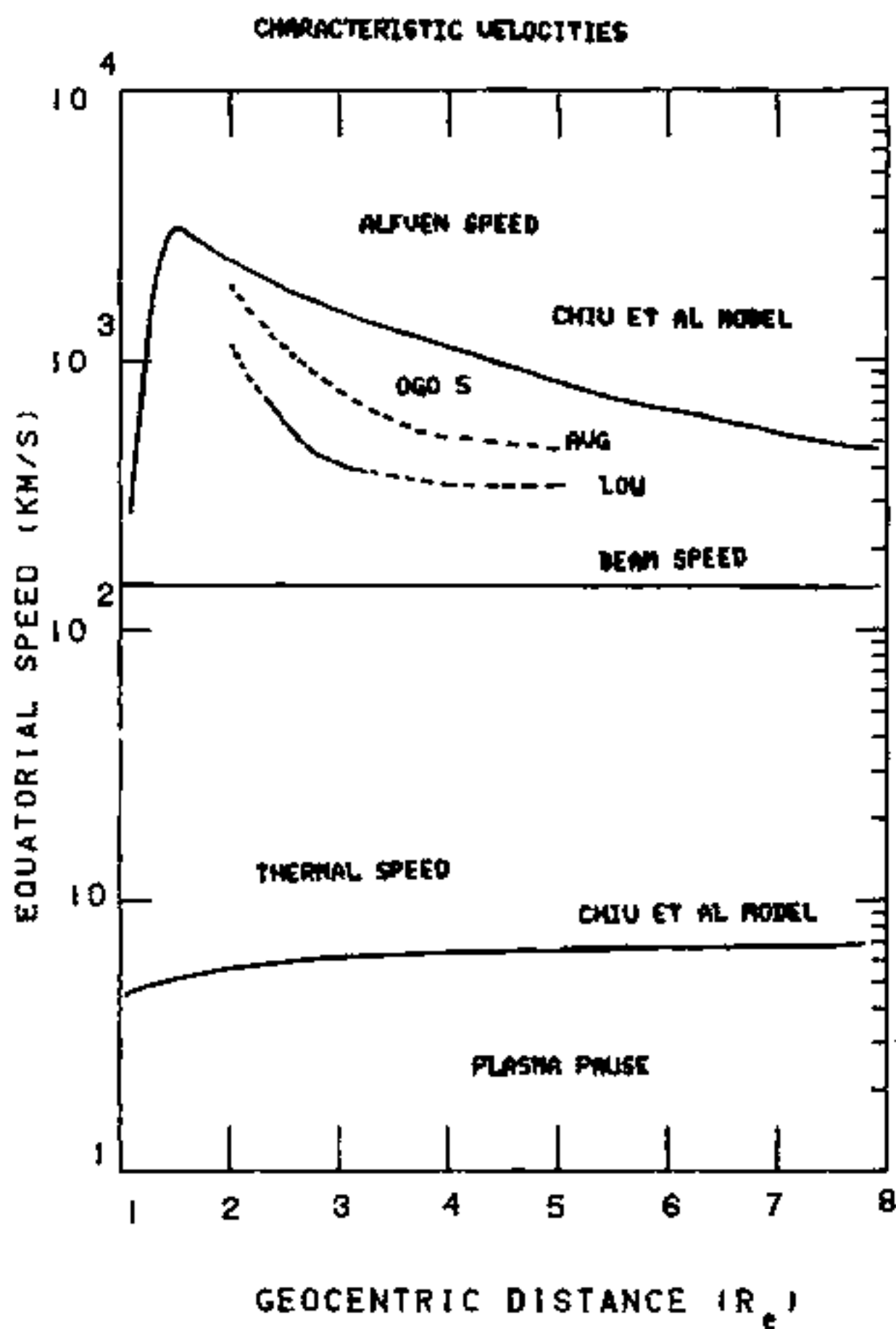

FIGURE 2

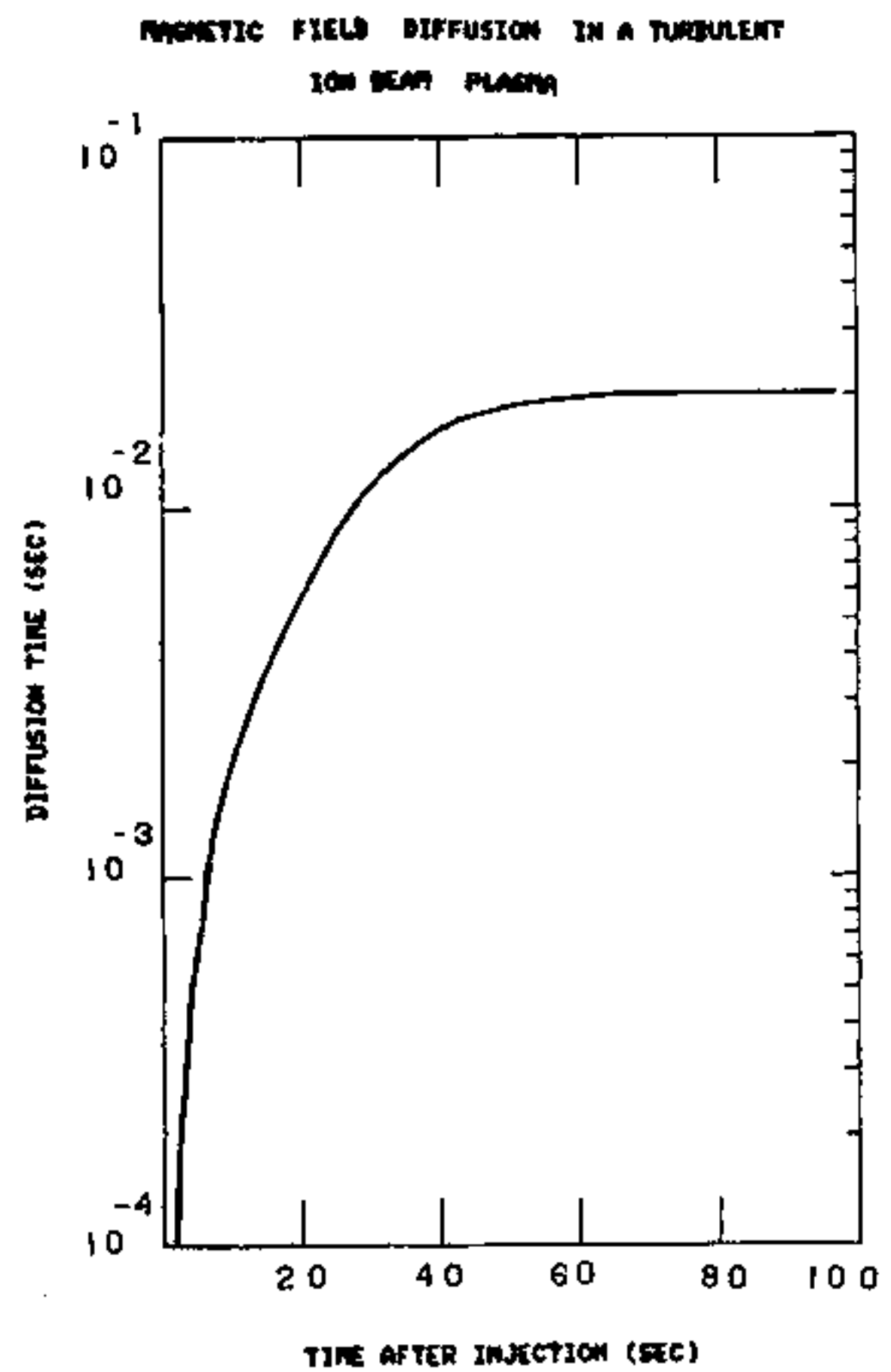

FIGURE 3

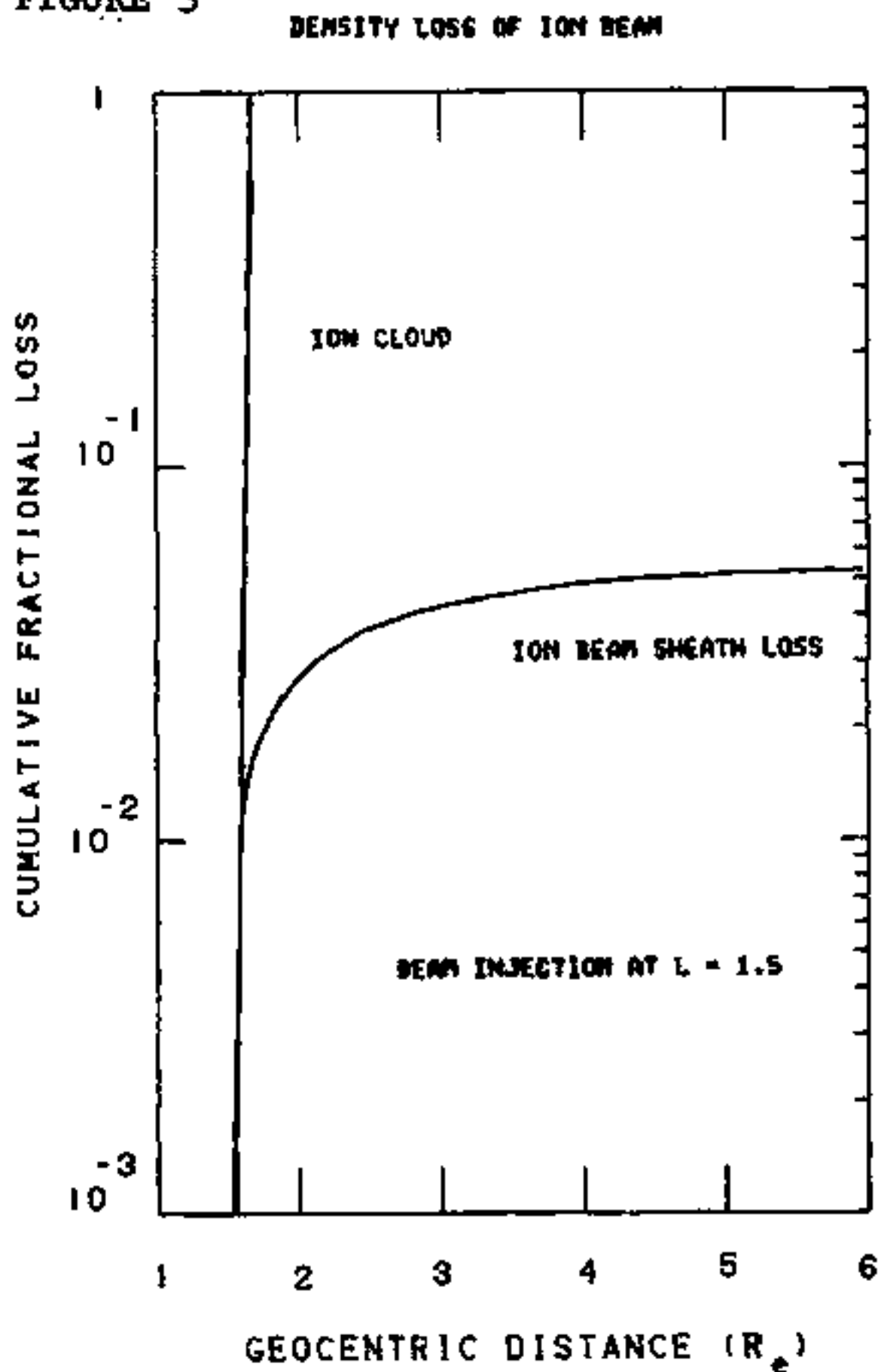

FIGURE 4

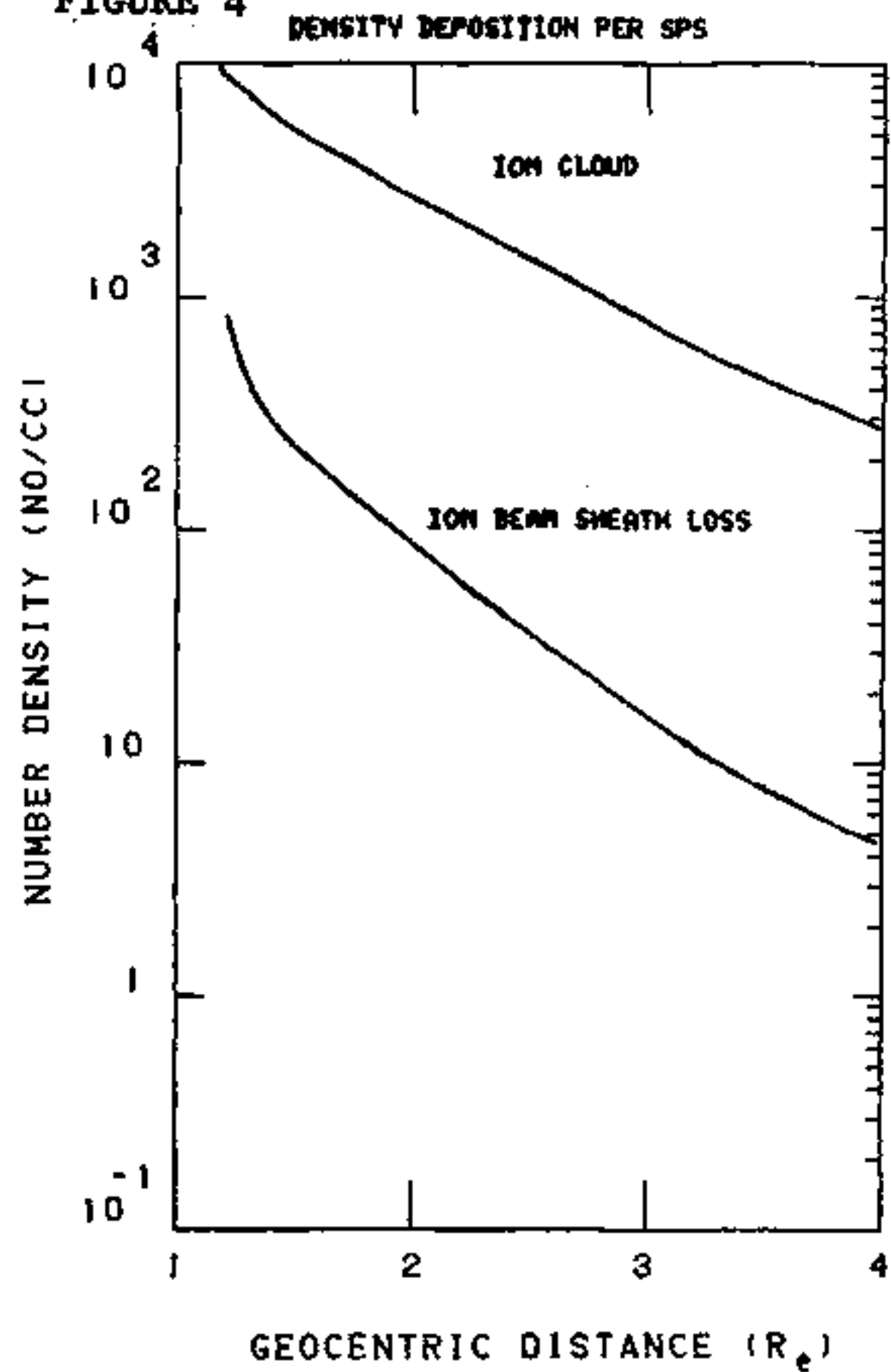
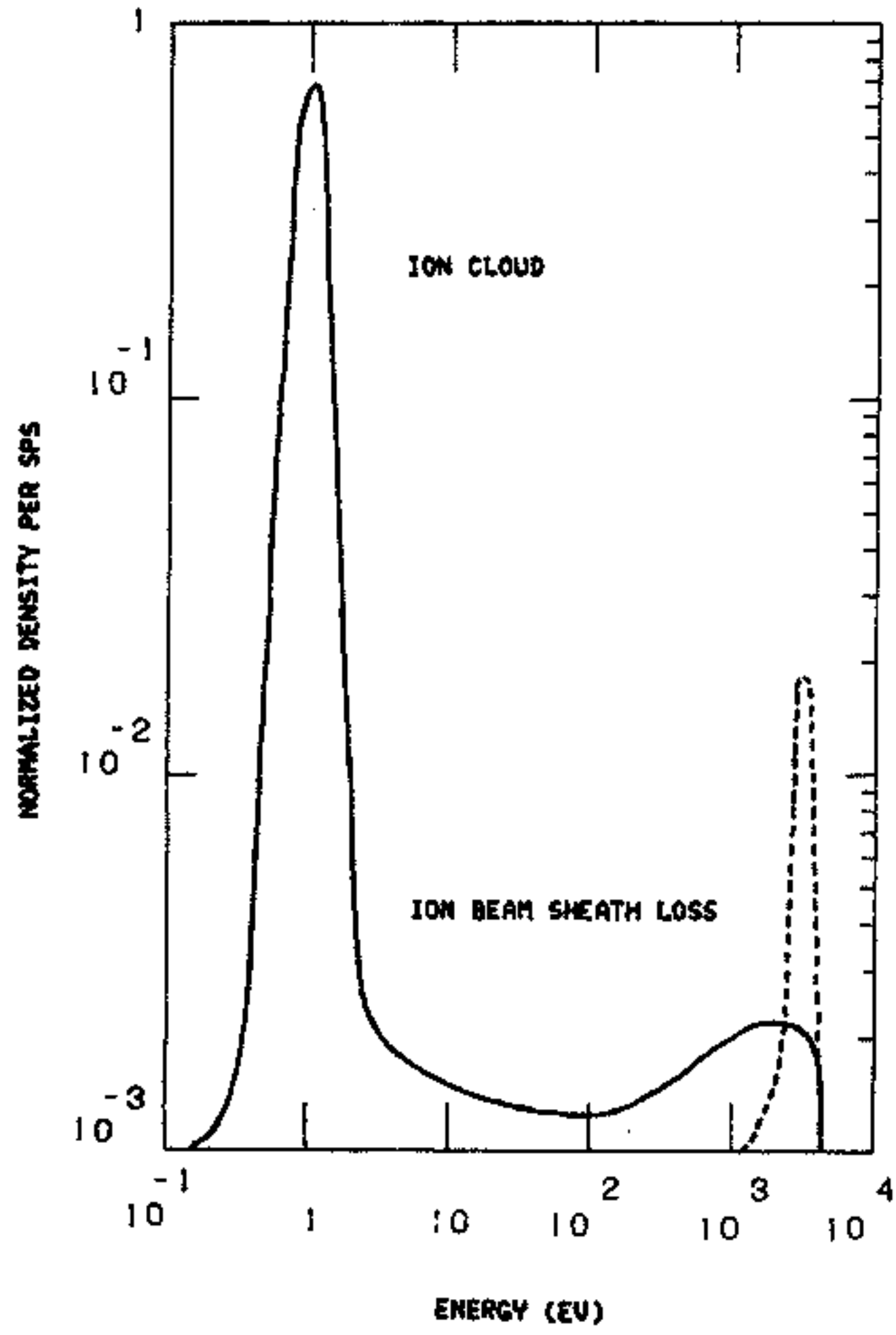

FIGURE 5

COMPARISON OF ION CLOUD AND ION BEAM
SHEATH LOSS MODEL DEPOSITED ENERGY SPECTRA



ON THE MILITARY IMPLICATIONS OF SATELLITE POWER SYSTEMS

J. Peter Vajk

Science Applications, Inc., 1811 Santa Rita Road, Pleasanton CA 94566

Satellite Power Systems (such as the SPS Reference Design currently under study by DOE and NASA) entail enormous expansions in total mass, power, logistic capabilities, and personnel in space. These expanded capabilities, far greater than for any other space programs envisaged during the next few decades, raise important questions about potential military uses of power satellites and related facilities, both on Earth and in space. Moreover, the emplacement of major economic assets vital to the economic security of a nation in outer space, beyond the territorial limits of any sovereign state, raises important questions about the vulnerability of such assets to overt military attack or to terrorist actions.

Under the auspices of the DOE Concept Development and Evaluation Program, these issues were addressed in the study reported here, with a view to answering two key questions. (1) Given the widespread recognition of the expanded capabilities in space represented by any SPS deployment program, how can the public in the United States and the international community at large be assured that a civilian SPS program is not, and will not become, part of the military system of a country deploying power satellites and related system elements? (2) Given a widespread perception that space-based systems such as power satellites are very fragile, and that assets outside the territorial limits of any country are especially open to attack, can it be confidently and convincingly demonstrated that the vulnerability of SPS is no greater than, or can be readily reduced to levels comparable to, the vulnerabilities of alternative energy sources in the same timeframe (2000 to 2030, or so)?

This study was performed on a totally unclassified basis, focusing attention primarily on the SPS Reference Design, but also examining some alternative system concepts where obvious differences could be expected. Certain key technologies were examined by experts in the respective fields to project reasonable levels of progress over the next twenty years or more to define the kinds of military threats which SPS could pose if military adapters of various kinds were attached to elements of the Satellite Power System. Some of the possibilities considered included particle beam weapons, high energy lasers, deliberate misdirection of the microwave power transmission beam, deliberate weather modification, electronic jamming, surveillance and reconnaissance, and various military support services, including transportation, communications, and navigation. Virtually all of these possibilities have the potential to pose significant military threats in the SPS timeframe. (Weather modification appears to be infeasible; deliberate misdirection of the microwave beam could not inflict significant damage except, perhaps, as a tool in psychological warfare.) Thus the need for safeguards to prevent such uses of SPS is real. Except for the use of space-based SPS facilities to launch reentry vehicles with nuclear warheads, none of the potential weapons systems which could be attached to SPS in the foreseeable future has the capability of inflicting damage remotely approaching the extent and lethality of the present strategic arsenals of the nuclear powers. The potential for development of SPS-based directed energy weapons of sufficient range, power, and accuracy to provide a highly effective ballistic missile defense (ABM) system deserves further study.

Considering the vulnerability of SPS elements to espionage, sabotage, mutiny, terrorism, or overt military attack, using either conventional weapons or any of the advanced technologies considered earlier, we were lead to conclude that the SPS hardware is no more vulnerable (or can readily be designed to be no more vulnerable) than conventional power systems on Earth today. The vulnerability of SPS elements to various types of attack is highly sensitive to design details. Thus vulnerability considerations and system design for survivability must be integrated with SPS engineering design and SPS program planning from a very early stage in the program, not added on as a last minute afterthought. Detailed assessments of vulnerabilities and of hardening techniques for space systems and components is not possible on an unclassified basis, since much of the pertinent information on lethality mechanisms and hardening techniques is classified. Short of a full-scale nuclear war (in which the existing electrical grid and pipeline systems in the U.S. are just as vulnerable as the SPS), the Reference Design system does appear to be highly vulnerable to electromagnetic pulses (EMP) induced in the power satellite itself by radiation (x-rays and gamma rays) from nuclear bursts outside the Earth's atmosphere. To survive large nuclear bursts (one megaton or more) at ranges of hundreds to thousands of kilometers, extensive circuit protection and hardening against large current and potential surges would have to be designed into a photovoltaic power satellite; it is difficult to estimate the weight and cost penalties for providing this protection, but alternative SPS concepts may prove easier and cheaper. (Note that a number of nuclear powers today are not signatories to the treaty prohibiting the testing of nuclear explosives in the atmosphere, under the ocean, or in outer space.)

Seven key safeguards have been identified for the SPS system. These would serve to protect nations on Earth from weapon systems being added to SPS elements deployed or operated by other countries, or to protect SPS elements from attack. These safeguards, obviously, would complement the existing safeguard of deterrence. The key safeguards are: (1) an international Resident Inspection Organization, which would report to the national governments of countries participating in RIO (whether or not they participate in SPS) the presence or absence of military systems added on to SPS elements, (2) a comprehensive long-range space surveillance system, to detect threats to SPS, to identify the origin of, and (if possible) give warning of, attacks by or against SPS elements, (3) self-defensive armaments for major elements of the SPS, (4) system design for survivability, (5) electronic countermeasures to protect SPS elements from electronic warfare attack, as well as certain types of electronic warfare equipment to assist the self-defensive armaments, (6) extensive and effective public education to correct misperceptions about SPS and about military capabilities which might be added to it, as well as to disseminate understanding about safeguards implemented in conjunction with SPS, and (7) a variety of new international agreements, including rules on permissible proximity of spacecraft to those of another country without prior consent of the other country and an unequivocal statement of the right to deploy self-defensive weapons in space.

Recommendations for further studies, both on a classified basis and on an unclassified basis, have also been developed in this study. In view of the significant military potentials of SPS, the fundamental question of whether or not the United States should undertake SPS on a purely civilian basis or on a joint military/civilian basis must be addressed following more detailed assessments of issues discussed above. It appears, however, that a purely civilian SPS program could be carried out by the United States in a manner designed to assure other nations that the SPS would pose no military threat to their national security.

SOME ASPECTS OF SPS ACCEPTABILITY IN EUROPE
Raefe M. Shelton and Ivor V. Franklin
British Aerospace Dynamics Group - Bristol, U.K.

INTRODUCTION

SPS has International implications because of its nature and its scale; we believe that these imply international involvement and participation. This in turn requires consideration of other nations' requirements and preferences.

SPS Acceptability embraces in a sense the whole scope of the US Concept Development and Evaluation Programme. In this paper it is intended to select a few areas where European, and in particular UK, conditions may differ from those upon which the US SPS Reference System were based. Three aspects of SPS acceptability will be discussed: Environmental, the Utilities interface, and Political and Public acceptability.

ENVIRONMENTAL ACCEPTABILITY

Although following the work on the possible radiation hazards, Europe and the UK are particularly concerned over contamination of the Electromagnetic environment, because of the high density of potential "victim" systems. Studies have been initiated at BAe on implications for Satellite communications, by the UK Home Office in conjunction with Sussex University on Ionospheric interactions and the generation of harmful harmonics, and a dialogue has been initiated with the UK Science Research Council to consider the implications for Scientific Research (particularly Radio-astronomy). Other areas requiring attention are Defense Systems, aircraft communication and navigation systems.

However, the greatest environmental problem for Europe, with its high population density and intense land usage, is that of Rectenna siting. The problem is made worse by Europe's higher average latitude; most of our major energy-consuming centres lie between latitudes 45° and 55° N. To serve these centres rectennae based upon the Reference System model would have long axes of up to 42 km and areas approaching 750 km^2 - ignoring longitude - offset effects. The siting of any appreciable number of such rectennae would involve displacing thousands, if not millions, of people.

Two approaches are being pursued. The first aims at reducing individual rectenna size by modifications to the power transmission system, either by the use of multiple beams or of intermediate relay stations employing hybrid laser/microwave transmission systems to obtain the benefits of each without their accompanying disadvantages. The second approach is to site rectennae off-shore. This approach is perhaps particularly appropriate for Europe; our geography is favourable, with a coastline which, when "straightened out", is twice as long as that of the US, with extensive regions with water depths of between 10 m and 30 m. More than 80% of Europe's major energy consumption centres lie less than 300 km from the coast.

ACCEPTABILITY TO THE ENERGY UTILITIES

SPS possesses two major characteristics, other than the economics and reliability inherent in its "non-depletable" nature. These are its constancy and the size of its "quanta". In both cases Europe is favourably placed to absorb SPS-derived electricity, due to our centralised national generating authorities, well-developed transmission and distribution networks, and our already-established facilities for power sharing across national boundaries. The UK particularly would have to look to off-shore rectenna siting, but to a large degree such siting could be based upon geographical and engineering consider-

ations, since with the possible exception of certain parts of the North and West Scottish coasts, a rectenna would never be far from the main distribution network. The 5 GW "quantum" in itself poses no great problem - current power stations of 2 GW output are being built. However, there is a difference which is of concern to our Central Electricity Generating Board. Current 2 GW stations are composed of 500 MW units; "outage" of one unit is acceptable, that of two units can be handled. Total and virtually instantaneous loss of 5 GW, due to a malfunction or disturbance to the phase control system, would throw an intolerable load on the distribution control system. Acceptability of the system would be enhanced by subdivision of the MPTS and the introduction of redundancy in critical elements, such that the probability of losing more than 1 GW at any one site was greatly reduced.

The second feature of concern to the Utilities is that which has often been mentioned as a "selling" point - that is, its constancy. Currently in the UK, baseload demand is about 20% of peak (10 GW : 50 - 55 GW). Present policy is that this load should be met by Nuclear Power. Nuclear Stations are not very amenable to load-following. SPS then becomes a direct competitor for a small proportion of the total demand. This proportion may change by AD 2000, but SPS acceptability would be greatly enhanced if it were more flexible and possessed some measure of capability for load-following, such as varying the solar flux incidence angle to the array; although this might pose thermal problems.

POLITICAL AND PUBLIC ACCEPTABILITY

Political acceptability cannot yet be judged; although interest has been expressed by many members of Parliamentary and other official bodies. The European position is made more difficult by the lack of an overall Energy Authority like the US Department of Energy. The International Energy Authority possesses very limited terms of reference at present, but could possibly be expanded to fill the role. The European Space Agency has the expertise (and in many quarters the interest) to co-ordinate the Space aspects, but at present has no mandate to consider Energy projects.

The position of the UK Department of Energy is that the environmental problems are the key, but will take no action until a decision to proceed is taken by the US. The UK Government's Energy policy is founded on present self-sufficiency, and relies for the maintenance of such self-sufficiency on the expansion of Nuclear Power, on Energy Conservation, and on economic competition between rival sources coupled to a "realistic" pricing policy, which should aid conservation! Some research into alternative energy sources is supported, mainly those which are indigenous and therefore support self-sufficiency.

Public acceptability has not yet been tested, since the concept is little known. Steps are being taken to widen contact with the concept; British Aerospace and its fellow contractors are currently sounding opinions from a wide range of British industrial, academic and research organisations, and a Press Conference is shortly to be held. However, an initial Press Release issued at the time of the award of the current Government Study Contract elicited considerable reaction from the media, whose response has been interested and not unfriendly.

CONCLUSIONS

There is an appreciation in Europe that the SPS concept could be developed by the US (or the USSR) without us, but not by us without the US! Nevertheless, many aspects of the system require international agreement, which is eased by international participation. Such participation involves consideration of international requirements - not forgetting the "Third World"!

As with all major projects, particularly Energy projects, the principal concerns are environmental, and conditions and priorities may vary in different parts of the world. System designs need to be flexible to meet differing requirements. Flexibility is also the keynote to meet the needs of the Utilities, who have a contractual responsibility to their customers.

The principal obstacle to political and public acceptability is the Imagination Gap (akin to Gordon Woodcock's Concept Shock). Space and Energy have heretofore been separate concepts; those concerned with Space projects find the scale of SPS unbelievable, while those concerned with Energy can swallow the numbers but class Space with Science Fiction! Until these points of view are brought together, the task of engendering the necessary political and economic will to bring SPS to pass will continue to be a difficult one.

STRATEGIES FOR MARSHALLING INTERNATIONAL SUPPORT FOR SOLAR POWER SYSTEMS

Douglas G. Bailey and Neal A. Irwin
IBI Group, 156 Front Street West, Toronto, Canada M5J 2L6

Solar power systems, and particularly the proposed Solar Power Satellite System, may have significant impacts upon global energy demands, with far-reaching consequences and specific benefits for Lesser Developed Countries. Were such systems in place, global demands for conventional energy might be lessened, and the prospects for longer term security of energy supplies for the LDC's might brighten appreciably. There are important potential roles for smaller industrialized countries such as Canada in interpreting the benefit of the development of solar power systems, into plans and projects that are longer-range in nature, and that spell out socio-economic development objectives that may become feasible for the LDC's were solar power systems more advanced.

The long-range plans proposed could come about as a consequence of the re-direction of Canadian multilateral aid, that amounts of approximately 40% of the country's aid budget, so that Canadian participation in multilateral activities is direct and intellectual as well as budgetary. Secondly, countries such as Canada could participate directly in the economic and technological development of large-scale projects such as the SPSS -- provided that those parties taking the primary role in its development can provide direction concerning such participation. Finally, Canada could provide the link between such major capital projects for energy technologies, and other technologies that are presently in the development stages. An example is recombinant DNA technology and the development of smaller CANDU reactors for nations too small to be directly served by the major energy technology efforts.

[Extended Abstract Not Received]

ALTERNATIVE INTERNATIONAL POLITICAL REACTIONS TO SPS

James R. Brownell, Jr., Ph.D. and Michael J. Stoil, Ph.D.
KAPPA Systems, Inc. - Arlington, Virginia

Several studies incorporated in the assessment of the Satellite Power System (SPS) concept and its societal implications refer to the issue of international reaction to SPS research and commercialization. The general findings of the earlier studies, summarized in the SPS Preliminary Societal Assessment (May 1979), suggest that "...an international organization is strongly suggested for SPS development and commercialization." An institution similar to COMSAT/INTELSAT is described as the optimum means of dealing with international reactions to SPS. The rationale for this finding appears to be based on the following implicit assumptions:

- international reaction to SPS will be analogous to previous reaction to the development of communications satellite technology (hence the comparison with INTELSAT);
- international reaction to, and acceptance of, SPS will be relatively coherent and, by Western standards, relatively rational;
- the primary concerns underlying international reaction to SPS will be technological (e.g., how SPS can be designed to optimize cost-effective energy transmission with minimum environmental impact) and, to a lesser extent, concerns of equity of distribution of SPS benefits; and
- existing norms of international law and treaties-in-force will provide the framework for international reaction to SPS.

This paper represents a critique of these assumptions from the perspective of the theory and practice of international politics. Observations of bloc and national behavior in international fora on "common heritage" resource issues suggest that primary attention in assessing alternative international reactions to SPS should be focused on the perceptions of national interest invoked by the development and implementation of satellite power systems. This argument is based on the following hypotheses:

- SPS development and implementation differs from the development of communications satellite technology in that SPS involves exploitation of resources which may be considered part of the "common heritage" of Mankind, and impinges directly on the future relative economic and political power capabilities of sovereign states. The best analogy to SPS development is therefore the development of deep-sea mining technology rather than communications satellite technology.
- International reaction to developments affecting "common heritage" resources consists of the varied reactions of national governments and blocs, rather than a single, rational, relatively coherent international reaction.

- The primary concern of nearly all national governments is the pursuit of perceived national interest rather than abstract technological concerns or concerns of international equity.
- The distribution of power and influence among international actors in the specific area of satellite power technology will be more likely to determine the ultimate international legal arrangements affecting SPS than existing international legal norms and treaties-in-force.

The paper provides support for these hypotheses, based on the experiences of the Third U.N. Law of the Sea Conference (UNCLOS III) and the World Administrative Radio Conference, and discusses their implications for the SPS concept. Specifically, the validation of these hypotheses suggests that the optimum means for achieving a favorable international climate for SPS lies in demonstrating its advantages to the national interests of the members of the international community. In effect, the success of SPS internationally will depend on how the SPS concept is "sold" outside the United States--politically as well as in scientific terms. The organizational characteristics of the ultimate agency responsible for the development and commercialization of SPS is less important.

As a result of this interpretation of the issues confronting international support for SPS, the authors maintain that:

- greater attention should be paid to the development of appropriate levels of SPS-related political and scientific interaction among governments and institutions that may become involved in the development and implementation of SPS;
- an effort should be made to examine the alternative reactions of key national governments to various possible SPS development and implementation scenarios; and
- an effort should be made to study means by which the SPS concept can be presented to the international political and economic communities (in addition to the scientific community) to achieve a favorable international reaction for SPS development and implementation, based on the perceived national interests of the key national governments.

The authors note that divergent national interests can be readily identified and, potentially, reconciled, based on the experiences of negotiation on similar resource issues. For example, aside from issues affecting national defense, the Soviet Union and the European Economic Community have often been successful in preparing common positions on raw material issues, based on a common position in favor of defending regional--as opposed to global--economic interests. Similar cooperation, based on a thorough understanding of perceived national interests, offers the best hope for international support for a U.S.-designed SPS concept.

INTERNATIONALIZATION OF THE SPS: U.S. POLICY ISSUES,
OPTIONS AND STRATEGIES

Stephen Gorove

The University of Mississippi Law Center - University, Mississippi 38677

Perhaps the most important key issue that U. S. policy makers will have to face is whether the United States should internationalize the SPS and, if so, in what manner the United States should proceed.

In order to arrive at a rational decision, a careful assessment must be made of the pros and cons of internationalization with reference to the totality of the basic value and institutional processes rather than on the basis of a single value or institutional alternative. Positive or negative answers may well depend on the meaning of the term "internationalization" and various possible forms which it may assume. A full-fledged analysis of the policy choice whether or not to internationalize should also take into account our experiences with other schemes of proposed internationalization, such as, for instance, the international regime governing the exploitation of the deep seabed or the resources of the Moon. Their relevance or lack of relevance with respect to the internationalization of the SPS should be clearly determined.

One major conclusion of a study of pros and cons could be that, in view of the anticipated huge financial outlay required for the development of SPS, it would appear to be in the U. S. interest to have the costs of research and development spread not only domestically between government and private enterprise but also internationally among nations of the world. Another conclusion may be that such policy would appear to reflect both altruism and enlightened interest: on the one hand, solar power as a spacial resource would be used for the benefit of mankind and, on the other hand, an international pool would be cost-saving and would likely recapture and reemphasize U. S. leadership. An additional advantage of such policy would be that it would undercut any argument by the developing nations that the current system is inequitable inasmuch as the benefits of outer space utilization accrue only to the space powers. Yet another conclusion of a study of pros and cons could point to the disadvantage of sharing U. S. control over the SPS, should the United States have to accept such sharing as the price of internationalization.

Once the preference for internationalization of the SPS as a U. S. policy option is established (and it is urged that it should be established soon), the United States should seriously consider taking global, near-global, regional or bilateral initiatives to pool material and human resources for the development of SPS programs. As one of its policy options, the United States could take a positive role in calling for an international pool of resources to help in the assessment of the feasibility, benefits and impediments associated with the development of satellite power systems and eventually assist in the development itself. Such scheme could include participation by all countries in some form, through their contributions to natural and human resources needed for the SPS program. Contributions could be taken into account when the eventual benefits would be reaped after the SPS system became operational. This would be to the advantage of all participating countries in that benefits would accrue commensurate to the amount of contributions. Key issues will include the criteria on the basis which human and material resources will be evaluated and also the question whether or not the total contribution by a single country or a group of countries ought to be the sole factor in determining the distribution of eventual benefits.

In the implementation of its proposal the United States may conveniently utilize almost all avenues of international cooperation to arrive at an agreement. On the politico-legal level the global approach may be initiated at the United Nations both before the General Assembly and UNCOPUOS and its Legal Sub-committee. With global approach at the technical level, the resources and rich experience of ITU-related bodies should be fully utilized in helping to investigate all relevant aspects of the SPS, including the effects of massive microwave power transmission on radio services. The technical Sub-committee of UNCOPUOS may provide further input and guidance as necessary. Specialized agencies, such as UNESCO and WHO, may also be called upon for assistance in their areas of competence.

On a less than global level, the experience of INTELSAT may provide useful insights to draw upon for possible framework. Regional agreements in some regions may be more difficult to negotiate but opportunities for such should be explored, especially with the Organization of American States. Insofar as bilateral cooperation is concerned, current research agreements on solar energy between the U. S. and other countries could be amended to include cooperation in the development of SPS in whatever form it may be agreed upon. An appropriate bilateral agreement may also be considered with the European Space Agency (ESA). Such cooperative project appears quite feasible in view of the close U. S. - ESA cooperation in the Shuttle/Spacelab project.

Initially, possibly for the next three-five years, these agreements could aim mainly at coordinating feasibility studies, including effects of microwave power transmission on humans and biota as well as on radio services, research of technical problems, determinations of appropriate sites for receiving antennas, and meeting of experts and many other matters. Possibly, some of these topics (such as exchange of information, coordination of research) are already covered in some current U. S. bilateral agreements pertaining to solar energy and, to that extent, this may facilitate negotiations. In the conduct of negotiations the United States may wish to proceed on a case-by-case basis taking into account its general relations with the foreign country.

There appears little reason that would prevent the United States from pursuing virtually all of the indicated international avenues simultaneously. Past experience, for instance, in the field of development of international agreements for safeguarding the peaceful utilization of atomic energy, show that the United States entered into many bilateral agreements while it simultaneously championed the establishment of the International Atomic Energy Agency which for many years did not come into existence.

International arrangements on whatever scale (bilateral, multilateral, regional, near-global or global) would appear to give the SPS program a substantial boost both psychologically (prestige-wise) and materially, particularly if developed countries like West Germany and Japan participate. As intimated beforehand, it would also take off the edge of the charge of injustice and inequity advanced by many developing nations. Also, once such agreements are negotiated, it is unlikely that countries would create difficulties in relation to the use of the geostationary orbit by invoking claims of sovereignty or the "common heritage"

principle or with respect to frequency allocation or perhaps even exposure standards. All in all, a cooperative program on the international level would likely speed up rather than retard the development of the SPS.

Should an international cooperative effort for the development of the SPS prove completely unsuccessful -- which appears somewhat unlikely -- the United States could still continue its own development program and puts its conscience to rest in the firm knowledge that current practices and recognized principles of international law are fully supporting the principle of freedom of use of outer space and that the United States has made a good faith effort to attempt to implement in a concrete manner the "common interests" principle of the 1967 Outer Space Treaty and open the door for wide international participation in the SPS program on the basis of equity and fairness.

SATELLITE POWER SYSTEM RECTENNA SITING STUDY

by James B. Blackburn, Jr. and Bill A. Bavinger
Rice University

This study was undertaken by the authors in association with Allan D. Kotin of Kotin and Regan of Los Angeles, California. The goal of this study was to determine if potential sites for receiving antennas existed within the Continental United States. A receiving antenna located at 35 degrees north latitude would require the dedication of approximately 35,000 acres to the elliptical rectenna and associated buffer zone (vertical dimension - 15.8 km; horizontal dimension - 12.0 km). The SPS reference design contemplates the development of 60 receiving antennas within the Continental United States over a 30 year time frame. Our approach to site availability was to eliminate areas as sites rather than attempting to locate sites. Three classifications of land use constraints were developed. These were (1) areas absolutely excluded, (2) areas potentially excluded, and (3) areas exhibiting characteristics that would exclude the reference-system rectenna but were available if design modifications were made. Data was gathered depicting the spatial coverage of variables within the three classifications. In all, 37 variables were mapped. Many variables were comprised of several gradients which were mapped separately. In all, 67 data items (excluding states and electrical reliability council regions) were mapped. Fifteen variables were classified as absolute exclusion variables, 21 were classified as potential exclusion variables and 30 were classified as design/cost variables.

To display the data, a base map was developed. This map used the Albers Equal Area Projection System and was overlain by 92,512 grid squares; 52,479 grid squares covered the Continental United States. The northernmost grid squares were 14 km vertically and 9.2 km wide while the southernmost grid squares were 14 km vertically and 12.2 km wide. The size of the grid square generally approximated the size of the rectenna with a buffer zone. Each grid square corresponds exactly with a United States Geographical Survey 7 1/2 minute quadrangle map. Each data item was mapped as being present or absent within a grid cell. Through the use of a Tektronic graphics tablet, the mapped information was transferred to the Rice University computer system. Subsequent analyses were conducted using the Rice Architecture Geographic Information System (RAGIS). RAGIS has more than 250 special operations for geographic information processing and utilizes a host language called Speakeasy to support and control its operations. Through the use of RAGIS, a series of analyses were undertaken to determine the availability of sites for receiving antennas.

The basic analytical tool involved the overlaying of 15 absolute exclusion variables to determine the extent of their spatial coverage. These 15 absolute exclusion variables were (1) inland waters, (2) Stan-

dard Metropolitan Statistical Areas, (3) other populated areas, (4) marshlands, (5) perennially flooded lands, (6) military reservations, (7) national recreation areas, (8) interstate highways, (9) navigable waterways, (10) designated habitats of endangered species, (11) topography unacceptable, (12) atomic energy commission lands, and (13), (14), and (15) lands excluded by three dimensions of electromagnetic compatibility problems. The overlaying of these 15 variables created a map showing those grid cells eliminated as rectenna sites; the remaining grid cells were considered as "eligible" areas.

The results of this initial overlay mapping are shown in figure 1. A table describing the mapped information is shown in figure 2. In figure 1, 40% of the Continental United States remains "eligible" for rectenna sites. This map was subjected to an accuracy check. A random sample of 180 excluded cells and 180 "eligible" cells was selected for detailed investigation. This examination showed that the 180 excluded cells were accurately excluded, but it also revealed that many so-called "eligible" cells should be reclassified as excluded when more detailed information is utilized. This result was expected due to the use of maps that presented data at the national scale. Twenty-four percent of the "eligible" cells were subject to reclassification based on more detailed information for exclusion variables other than topography. A detailed consideration of the topographic constraint proved difficult, however. Previous design studies indicated that a rectenna could be constructed wherever a bulldozer could go, a rather vague criteria. Detailed consideration of topography led to the discovery of significant cost increases as the slope of the land increased. Consequently, three additional topographic gradations were mapped and examined in light of slope constraints intended to represent cost increases in excess of \$250 million. These three classes of land form were then analyzed in detail, leading to the finding that 4% of the "flatlands" were ineligible, 33% of the "mostly flatlands" were ineligible, and 76% of the "residual" lands were ineligible. Of course, these areas could become eligible if one is willing to accept additional costs beyond the \$250 million threshold.

Four additional overlay maps were developed in this study. These added other variables to the map shown in figure 1. The "worst case" summary map added 13 potential exclusion variables to the 15 absolute exclusion variables. This map indicated 17% to the Continental United States to be "eligible." Although siting problems will be encountered and certain areas of the United States may have less "eligible" land than is desirable, our study indicates that rectenna siting will not represent an insurmountable problem if the Satellite Power System were to be implemented.

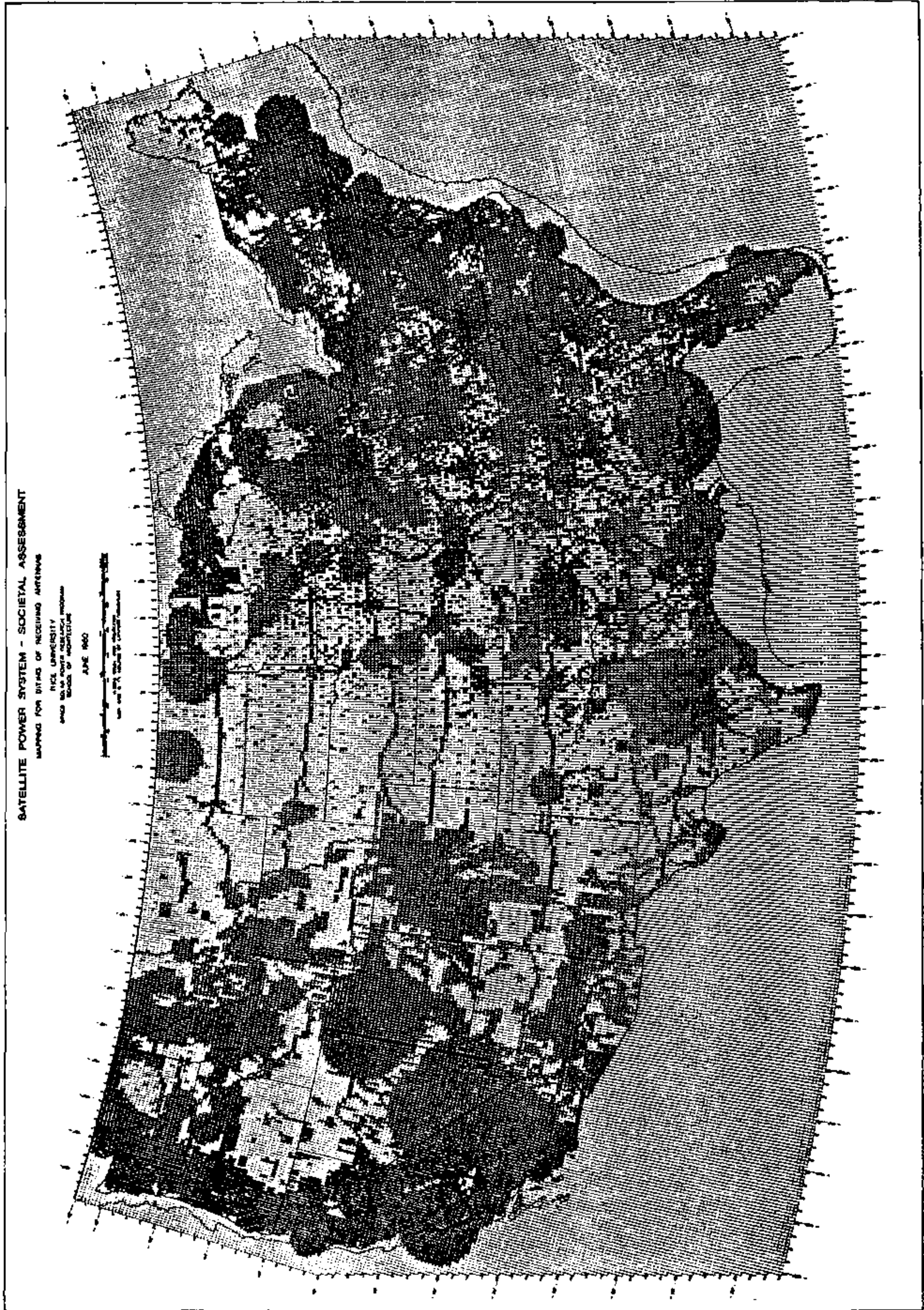

figure 1 519

GRID SQUARE PROFILE OF SUMMARY MAP 2							
STATES	'ELIGIBLE' LAND	PERCENT OF TOTAL LAND	TOTAL LAND EXCLUDED	EXCLUDED GRIDS SUMMARY MAP 1	EMC ASD	EMC A100	EMC A150
Alabama	166	20	646	490	198	0	248
Arizona	785	42	1073	997	93	0	73
Arkansas	353	39	532	524	107	0	0
California	235	8	2432	2249	288	298	987
Colorado	589	33	1171	1169	93	0	0
Connecticut	0	0	85	83	77	0	0
Delaware	3	8	33	31	17	0	0
Florida	109	12	768	684	127	0	167
Georgia	238	25	701	595	229	0	45
Idaho	575	30	999	936	93	0	14
Illinois	299	30	693	607	360	0	0
Indiana	140	22	476	458	105	0	0
Iowa	531	52	473	371	208	0	0
Kansas	1027	72	393	318	108	0	0
Kentucky	197	29	479	435	144	0	0
Louisiana	152	20	602	585	187	0	0
Maine	468	74	163	141	56	0	0
Maryland	15	7	180	165	95	0	0
Massachusetts	2	1	162	142	156	64	0
Michigan	494	44	611	534	300	0	0
Minnesota	665	41	951	843	156	133	0
Mississippi	327	42	442	379	110	0	23
Missouri	711	58	497	435	120	0	0
Montana	1752	61	1081	1081	0	0	0
Nebraska	1136	81	265	208	92	0	0
Nevada	599	31	1327	734	0	0	1066
New Hampshire	41	24	125	107	59	0	0
New Jersey	0	0	141	141	90	0	0
New Mexico	1155	58	811	811	0	0	0
New York	213	23	677	656	216	0	0
North Carolina	72	8	768	735	335	0	0
North Dakota	888	61	558	233	0	420	0
Ohio	87	11	649	610	243	0	0
Oklahoma	641	55	508	490	93	0	0
Oregon	764	42	1052	970	141	0	0
Pennsylvania	131	16	656	643	349	0	0
Rhode Island	0	0	17	16	17	1	0
South Carolina	25	4	483	414	314	0	0
South Dakota	1218	85	199	199	0	0	0
Tennessee	119	17	574	516	339	0	0
Texas	1924	45	2263	1796	334	0	656
Utah	305	20	1159	921	0	0	640
Vermont	35	19	145	137	31	0	0
Virginia	60	9	591	555	191	0	0
Washington	348	26	980	897	340	0	0
West Virginia	102	24	307	307	5	0	0
Wisconsin	548	51	515	424	238	0	0
Wyoming	1046	58	746	746	0	0	1
NERC REGIONS							
WSCC	7282	36	12853	11533	1048	298	2781
MARCA	5350	66	2693	2038	581	553	0
SPP	3558	55	2863	2651	692	0	0
ERCOT	1321	41	1869	1444	241	0	656
SEBC	968	17	4502	3933	1739	0	483
NAIN	1120	46	1267	1109	557	0	0
ECAR	879	22	3039	2849	994	0	0
MAIC	83	10	699	679	390	0	0
NPCC	759	35	1374	1282	612	65	0
TOTALS*	21320	40	31159	27518	6854	916	3920

figure 2

RELATIONSHIP OF ELIGIBLE AREAS TO PROJECTED ELECTRICAL DEMAND

Allan D. Kotin
Kotin & Regan, Inc.

Siting of 60 ground receiving stations (rectennas) for the SPS may pose a problem due to the large area per rectenna (15,000 hectares, 38,000 acres) and numerous siting constraints. This presentation extends the analysis of potentially "eligible" areas defined in an extensive computer mapping effort by Rice University in which conditions which would preclude rectenna construction were mapped on a 7.5 minute national grid in which each grid cell corresponds roughly to a single rectenna site. The major topics considered are: (1) other factors which will tend to reduce the number of available sites; (2) the relationship of eligible areas to the "need" for SPS power, as reflected in projected regional generation estimates; and (3) some preliminary ranking of U.S. regions in terms of siting difficulty.

The use of smaller rectenna sizes has little effect in reducing the area excluded from consideration for potential rectenna sites. With a nominal $\frac{1}{2}$ -area site (9.1 x 7.2 km, excluding buffer) no excluded areas are reclassified as eligible. Even with a smaller $\frac{1}{4}$ -area (6.5 x 5 km) rectenna, only 3% of the excluded sites become "eligible". The use of smaller sites does, however, increase the proportion of "eligible" sites which remain eligible upon closer scrutiny; the retention of "eligible" cells increases from 29% to 49% with a $\frac{1}{2}$ -size site and from 29% to 76% with a $\frac{1}{4}$ -size site.

Since the SPS reference concept includes a design only for land based rectennas, it is impossible to specify an appropriate set of exclusion variables for siting analysis which reflect the rectenna's structural design, e.g. bottom conditions, tide height and force, and numerous climate variables. An analysis of non-structural exclusion variables, e.g. continental shelf, navigation lanes and electromagnetic (EMC) exclusion areas, suggests some enhanced availability on the Atlantic coast, mostly south of New Jersey and a modest increase in the Gulf and New England coasts.

The likelihood of actually siting a rectenna in an isolated area with few adjacent eligible cells is considerably lower than in an area with a large number of adjacent "eligible" grid cells. Two classifications of isolation were established: (1) cells which did not fall within a two-by-two grid pattern of eligible cells, i.e. there are not at least four adjacent eligible cells within which to acquire one specific site; and (2) cells which did not fall within a three-by-three pattern containing nine adjacent eligible cells.

Imposition of the three-by-three constraint on eligible areas almost eliminates eligible areas in the Mid-Atlantic (MAAC) region, where the number of eligible cells is reduced to 21 or only 2.7 percent of the total. In all other regions, there remain more than 150 eligible cells. The imposition of only a two-by-two constraint does not appear to have nearly as drastic an effect in the east and still leaves all other regions with substantial numbers of eligible cells.

The relationship of eligible areas to regional power distribution indicates that there are an apparently adequate number of "nominally eligible" sites in all nine U.S. electric reliability council (ERC) planning regions in comparison to projected electrical generation. The projections of electrical generation by ERC region through the year 2000 were based on Mid-term (MEFS) projections and the

long term (LEAP) projection published during 1979 by the Energy Information Administration (EIA) of the Department of Energy.

Projections based on several nuclear and fuel price scenarios were considered and showed little variation with respect to allocation of electrical consumption by region. In addition to stability of allocation among regions even through the year 1995, the EIA projections also showed a high degree of stability in total electrical generation through the year 1995 over a wide range of scenarios. In all cases total electrical generation varied only modestly and the range of generation was from 4,355 trillion kilowatt hours to 4,438 trillion kilowatt hours.

The attached regional generation map shows the boundaries, projected generation (year 2000), share of national total and number of allocated sites. These projections and allocations are based on the Series C (Medium demand-Medium supply) scenario published by EIA in the 1978 Annual Report to Congress, but the allocations would equally apply to most other scenarios.

Individual regions vary widely with little or no pattern of geographic size vs. allocated rectennas. In the SERC (Southeast) region, 13 rectennas (out of 60) are required to meet 21% of national demand or 1,044,000 gigawatt-hours. The smallest of the regions in terms of generation is the large MARCA region (Dakotas, Nebraska, Minnesota) with only 2 rectennas to meet 4.1% of national demand. Other regions with high rectenna allocations are ECAR (Indiana, Ohio, Pennsylvania, etc.) with 13 rectennas and WSCC (eleven western states) with 11.

More significant than the number of rectennas or the number of eligible sites is the ratio between the two. This ratio of "eligible" areas to "required" sites can be expressed for several different energy scenarios and also for different definitions of eligible areas, e.g. with and without isolated areas, with and without considering EMC (electromagnetic compatibility) exclusions. A series of such ratios are presented as ranking variables 1-6 in the attached ranking table. Even without isolated areas, all but one of the regions (MAAC) has at least 12 times as many cells as required sites (variable 6). If all eligible cells are considered, the minimum ratio of cells per site in any region is over 20 to 1, and in all but two regions (MAAC, SERC) there are approximately 100 times (or more) eligible cells as there are "required" sites. Hence, even if a substantive proportion of nominally eligible sites prove to be unsuitable upon closer scrutiny, scarcity of available sites should not be a problem.

The ranking table also shows a variety of other indices of siting "feasibility" by region, including: projected capacity increase; incidence of all potential exclusion variables; incidence of a subset of design and potential exclusion variables identified as having adverse environmental impact; and various indicators of the size of load centers within the region.

In general the table indicates few problems of availability except in the mid-Atlantic (MAAC) region. Scarcity of large load centers relative to allocated rectennas may be a problem in parts of the midwest (MARCA) and west (WSCC).

RECTENNA SITING FEASIBILITY RANKING BY REGION

RANKING VARIABLE

NERC REGION

VALUE	<u>ECAR</u>	<u>ERCOT</u>	<u>MAAC</u>	<u>MAIN</u>	<u>MARCA</u>	<u>NPCC</u>	<u>SERC</u>	<u>SPP</u>	<u>WSCC</u>	<u>TOTAL</u>	<u>MEAN</u>
1) Total Eligible Areas Without EMC	1,069	1,746	103	1,278	6,005	851	1,537	3,770	8,602	24,961	2,773
2) Total Eligible Areas With EMC	879	1,321	83	1,120	5,350	759	968	3,558	7,282	21,320	2,369
3) Net Eligible Areas Without Isolated Areas	314	853	21	450	4,233	451	165	2,490	5,578	14,555	1,617
4) Eligible Areas Without EMC/ No. of Required Sites	118.8	349.2	25.8	255.6	3,002.5	170.2	118.2	628.3	782.0	416.0	--
5) Eligible Areas With EMC/ No. of Required Sites	97.7	264.2	20.8	224.0	2,675.0	151.8	74.5	593.0	662.0	355.3	--
6) Eligible Areas Without Isolated Areas/ No. of Required Sites	34.9	170.6	5.3	90.0	2,116.5	90.2	12.7	415.0	507.1	242.6	--
7) % of Potential Exclusion Variables in Eligible Areas											
8) Projected Capacity Increase - Series C Nuclear Moritorium	7,532	4,030	2,812	2,838	1,383	4,517	8,119	5,147	11,977	48,355	5,373
9) Projected Capacity Increase - Series C Mid-Mid	7,481	4,483	3,625	3,932	1,992	3,636	10,385	6,339	13,544	55,417	6,157
10) Incidence of Environmental Impact Variables											
11) Total Load Centers \geq 5.0 Gigawatts (Rectenna Capacity)	2	2	1	1	0	1	4	1	3	15	1.7
12) Proportion of Load Centers \geq 5.0 Gigawatt Capacity	0.08	0.17	0.14	0.08	0.00	0.09	0.12	0.06	0.10	--	--
13) Total Load Centers \geq 1.0 Gigawatts (Capacity of 1000 Megawatt Line)	18	8	4	4	3	4	32	12	14	99	11
14) Proportion of Load Centers \geq 1.0 Gigawatt Capacity	0.72	0.67	0.57	0.33	0.13	0.36	0.94	0.67	0.48	0.58	--

523

Sources: Regional energy projections per EIA mid-term forecasts (Annual Report to Congress, 1978: Published April, 1979); load center analysis per Oakridge National Laboratories' projection of regional energy requirements by BEA region, published 1979; all area analysis per Rice University "Eligible Areas for Rectenna Siting" by J. B. Blackburn, Jr.

Kotin & Regan, Inc., 1980

Regional Generation (2000) and Rectenna Allocations

524

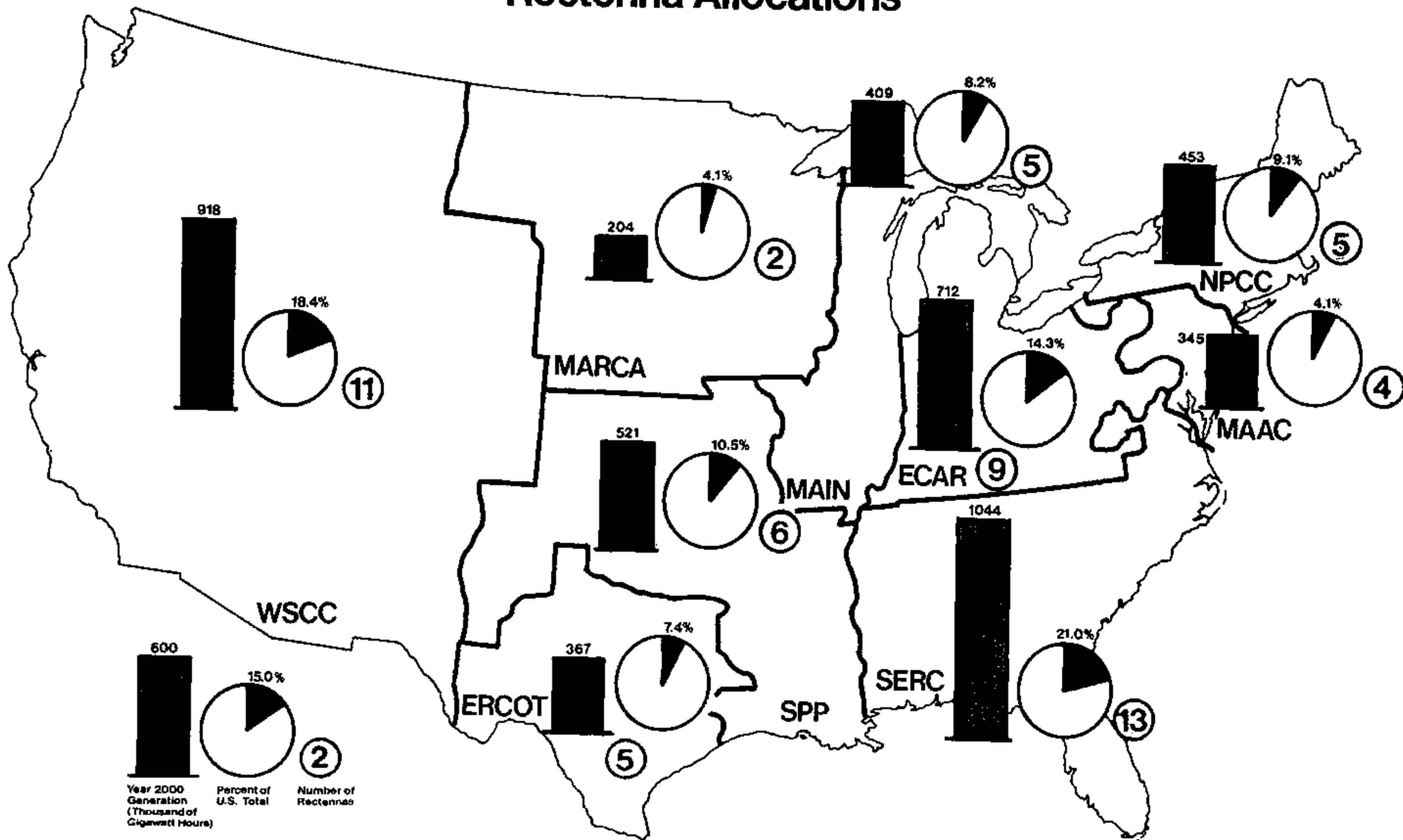

PROTOTYPE SOCIETAL ASSESSMENT OF THE IMPACTS OF SITING AND CONSTRUCTION
OF AN SPS GROUND RECEIVING STATION

Arrie Bachrach

Environmental Resources Group - 6380 Wilshire Boulevard
Los Angeles, California 90048

This report is a prototype assessment of the societal impacts of siting and constructing a Satellite Power System (SPS) Ground Receiving Station (GRS). The objectives of the study are: 1) to develop an assessment of the non-microwave-related impacts of the reference system SPS GRS on the human environment; 2) to assess the impacts of GRS construction and operations in the context of actual baseline data for a site in the California desert about 250 kilometers north of Los Angeles referred to as Rose Valley/Coso, and 3) to identify critical GRS characteristics or parameters that are most significant in terms of the human environment.

At the Rose Valley/Coso GRS study site (36°N latitude), the rectenna field, which is the area of the GRS where the microwave energy is collected and converted to electrical energy, would be an ellipse 13.4 km (N-S) by 10.0 km (E-W) and would enclose an area of about 10,500 hectares. An elliptical buffer zone 1.35 km (N-S) by 1.0 km (E-W) would surround the rectenna field. The rectenna would contain about 2.5 million 3 meter by 10 meter panels connected end-to-end in long continuous rows. Approximately 450 workers would be required for 24-hour/365 days per year operation.

GRS construction is expected to require 25 months, with an average work force of 2,500 and a peak work force of 3,200. Major materials requirements include: 11 million tonnes of aggregates and ballast, 1.4 million tonnes of cement, 6.5 million cubic yards of concrete, 1.7 million tonnes of steel and 170,000 tonnes of aluminum. Other construction phase requirements include: maximum annual water demand of 3-15 million cubic meters (the wide range resulting from uncertainties in dust control and soil stabilization measures), and maximum incremental electrical demand of 16 MW. Total onsite construction costs are estimated at \$1.7 billion.

In general, existing land use in the study vicinity, like that throughout rural portions of the southwestern U. S., is not notably intensive (less than 30 percent on average) or extensive (approximately 15 percent of the land has no designated use). Multiple land uses (Most commonly recreation, natural resource management, grazing and mining) exist over about 35 percent of the area. Over 90 percent of the general area (and the GRS study site as well) is controlled by the Federal government. The 2.250 square kilometer area that would be expected to experience socioeconomic impacts as a result of GRS development had a 1977 population of over 27,000 with 21,000 of this total contained in the two communities of Ridgecrest and China Lake. Resource industries, government and trade are the dominant employment sectors in the area. As might be expected given the region's sparse population and non-extensive and intensive land use patterns, local governments' tax and revenue base are quite small. Rose Valley possesses archaeological resources of considerable significance and sensitivity; a 370-hectare portion of southern Rose Valley has been nominated for inclusion in the National Register of Historic Places. Aesthetically, the study area is generally lacking in outstanding or dramatic visual features.

Key impacts identified include: total displacement of existing site land uses;

total disruption of site archaeological resources and the visual resources of the vicinity, and potentially significant socioeconomic impacts, particularly during GRS construction. Socioeconomic impacts would stem largely from the immigration of construction workers (and their dependents) and secondary employees associated with GRS development. Rapid growth in rural areas can overtax the financial and service capacities of local agencies and can have adverse effects on the social fabric of small, stable communities. Peak construction phase population immigration is estimated at 3,900 at Rose Valley/Coso, which would strain local infrastructure capacity somewhat. However, immigration (and impacts) would be larger in more remote areas, since roughly 30 percent of the construction work force is within daily commuting range of Rose Valley. A key element in mitigating socioeconomic impacts at Rose Valley/Coso (and elsewhere) is the provision of sizable onsite housing facilities for GRS construction workers.

Critical project parameters revealed include: the sheer size and intensity of use of the the contiguous land area required by an SPS GRS; the lack of flexibility in siting individual rectenna structures once the rectenna field boundaries are established; the difficulties in finding suitable sites that do not conflict with other societal needs and values; the proposed two-year GRS construction schedule, which has significant implications for socioeconomic impacts (i.e. peak population immigration) as well as possible logistical problems stemming from the delivery of huge volumes of construction materials to the site -- both which could be reduced by extending the construction schedule; and public vs. private GRS ownership, which has significant implications for GRS tax base impacts on the siting area (e.g. publicly owned facilities produce no property tax revenues).

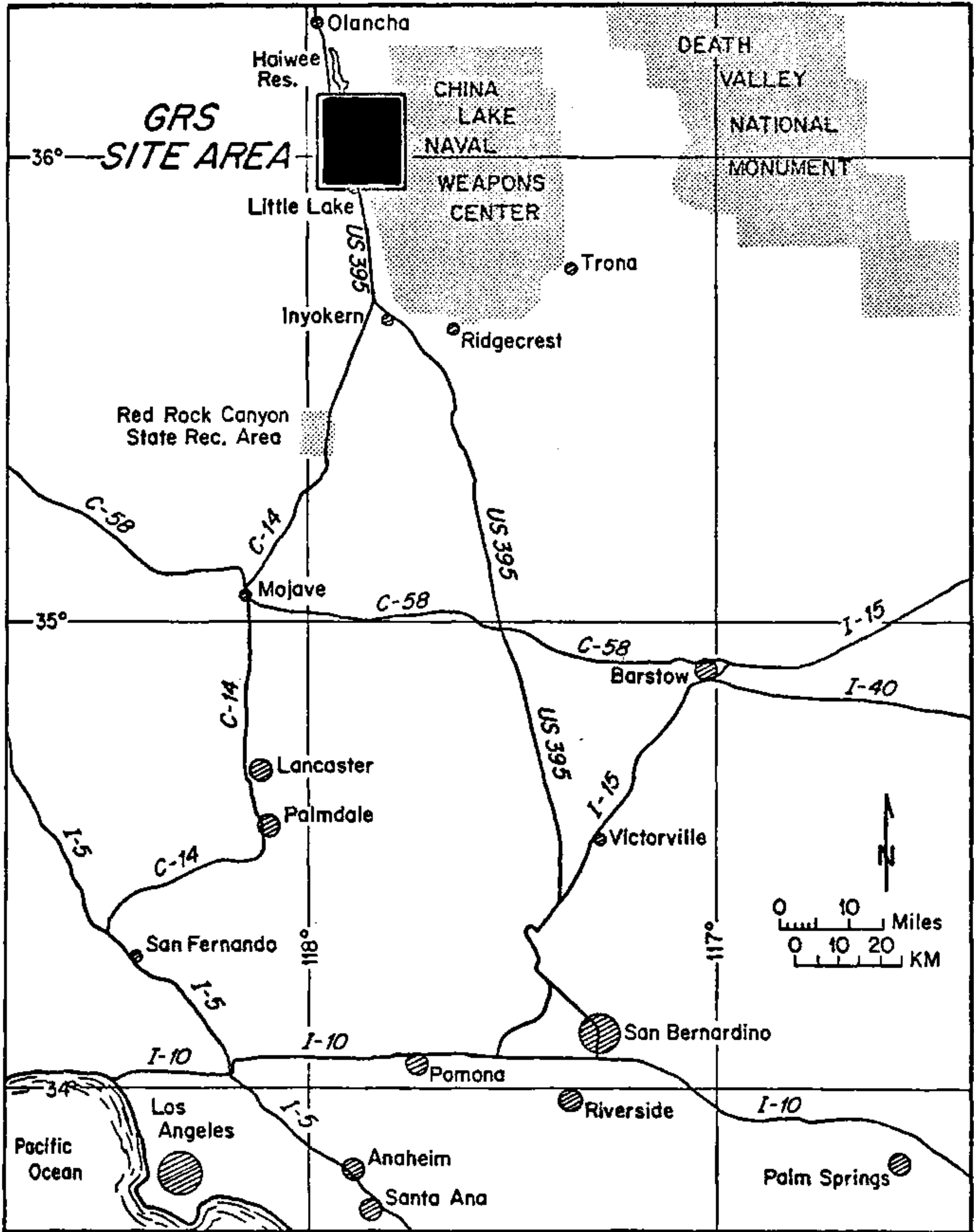

Figure 1 LOCATION OF GRS STUDY AREA

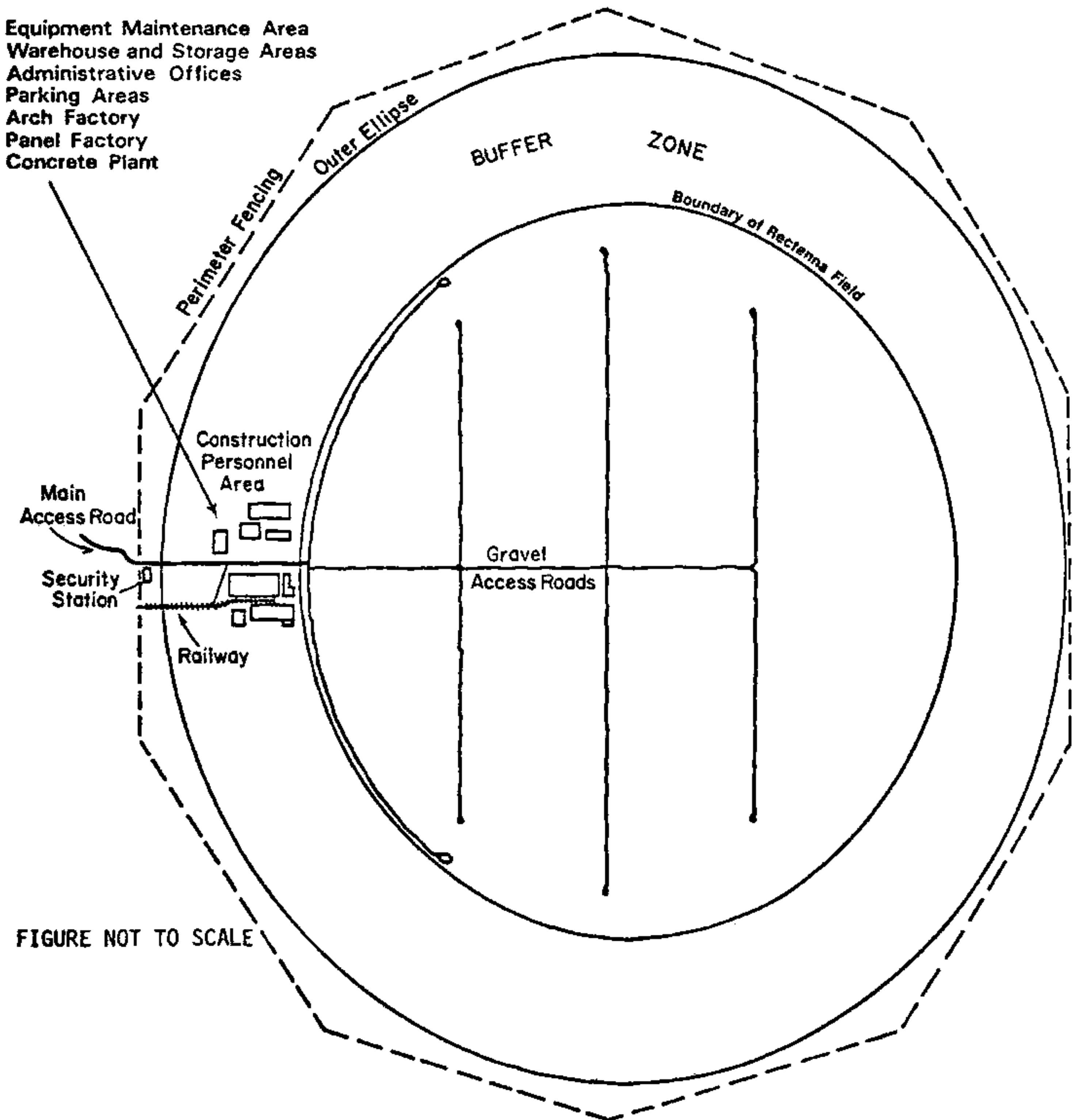

Figure 2 GRS CONSTRUCTION PHASE: SCHEMATIC LAYOUT
 (BASED ON FIGURES PRESENTED IN GENERAL ELECTRIC, 1979 AND ROCKWELL, 1979)

POTENTIAL FOR RECEPTION OF SPS MICROWAVE ENERGY AT OFFSHORE
RECTENNAS IN WESTERN EUROPE

P. Q. Collins

Imperial College of Science and Technology, London, England

There is an urgent need to establish the feasibility of receiving substantial quantities of energy from a Satellite Power System (SPS) in Western Europe (WE). Until this is done it is unlikely that the SPS will be considered as a serious candidate for future electricity supply by WE energy policy makers. The various problems associated with the SPS microwave power transmission and reception are already under investigation (see rest of this volume). When these studies are complete, the 'bottom line' for WE is to find sites for perhaps forty 5 GW rectennas, which could provide approximately 20% of WE electricity demand in the year 2030. The selection of sites on land in WE would involve very substantial data handling, and is inherently unpromising due to the high population density. The selection of offshore sites does not face this problem, and was considered more likely to lead to a near-term positive result.

For the present study a deliberately simple design, based on tried technology, was considered: The rectenna elements and structure are supported on light piles or floats, and completely surrounded by a protective sea wall. The cost of the sea wall depends on the depth of the water, and so site evaluation was restricted initially to areas with water depths of less than 25 metres, between 10 and 50 km offshore. Some twenty such areas of suitable size were identified around the Northern coast of WE, comprising some 20,000 square kilometres in total. The major factors relating to the offshore sites considered relevant to siting were:

- 1) Water depth
- 2) Distance from shore
- 3) Tidal range (including extremes)
- 4) Tidal currents
- 5) Wave heights and directions (including extremes)
- 6) Shipping lanes and traffic
- 7) Marine environment - fisheries, sea birds
- 8) Sea bed conditions - for support and/or tethering
- 9) Wind conditions
- 10) Other weather conditions - temperature, precipitation, lightning
- 11) Aircraft routes and telecommunications in surrounding area

Additional factors relating to the land interface are:

- 12) Distance to major electricity demand centres
- 13) Distance to electricity grid interconnections
- 14) Availability of alternative generating capacity
- 15) Distance to docks, manufacturing facilities, etc.

Data was readily available on most of these factors for the North Sea and Channel coasts, and on the basis of factors 1 - 10 above, some twelve areas were selected at which one or more rectennas could probably be sited -- many in water depths of 10 metres or less. The distribution of these areas was Belgium 1; Denmark 2; France 2; West Germany 2; Netherlands 2; U. K. 3. The Atlantic and Mediterranean coasts of WE have very few areas of water depth less than 25 metres. These areas, and the deeper water areas, will be considered in a later study.

The feasibility of siting rectennas in some of the chosen areas would depend on the exact size and shape of the rectenna. At 50° Latitude the 'footprint' of the SPS microwave beam is elongated by a factor of two in the North-South direction, which increases the area required and rules out some otherwise attractive areas, such as East-West coastlines. Strategies for reducing this problem include 1) specifying a longitude offset between the transmitting antenna and the rectenna to alter the direction of the long axis; 2) altering the beam cross-section (e.g. to an East-West ellipse) to reduce the North-South extension of the rectenna; 3) using a smaller rectenna with a lower power output; 4) reducing the size of the rectenna for the same power output through design advances in the microwave beam formation.

Conclusions

The siting of rectennas in WE coastal waters looks very promising. A dozen shallow water coastal areas have been identified which merit more detailed study and comparison -- particularly of likely costs. There is thus a real possibility of establishing with high confidence a number of feasible WE rectenna sites in the near future.

Though offshore rectennas would require additional construction expenses, they could be sited so that no human habitations were within 15 km or more of the microwave beam centre. This would allow greater freedom in the choice of transmitting antenna aperture illumination function, as the near sidelobe levels could be higher than on land. This could be particularly valuable if the rectenna output were subsequently to be increased by transmitting power to it from a second microwave beam, as appears possible (R. V. Gelsthorpe, ERA Technology Ltd., Private Communication). If feasible, this would be a critical innovation, as it could reduce the number of sites required by 50%.

There is some mismatch between the availability of offshore sites and demand for electricity in WE countries -- particularly in connection with the large conurbations in central France and West Germany. However, the national electricity grids in WE are becoming progressively more interlinked, and it seems likely that this will not pose any serious problems over the period 20 to 50 years in the future.

It is recommended that detailed cost studies for construction and integration of rectennas at particular sites should be performed, as well as a comparative study of deeper water sites.

PRELIMINARY SPS MATERIALS ASSESSMENT

R. R. Teeter and W. M. Jamieson

Battelle Columbus Laboratories - 505 King Avenue, Columbus, Ohio 43201

Presently, there are two SPS reference design concepts (one using silicon solar cells; the other using gallium arsenide solar cells). A materials assessment of both systems was performed based on the materials lists set forth in the DOE/NASA SPS Reference System Report: "Satellite Power System Concept Development and Evaluation Program"⁽¹⁾ October, 1978.

This listing identified 22 materials (plus "miscellaneous and organics") used in the SPS. Tracing the production processes for these 22 materials, a total demand for over 50 different bulk materials (copper, silicon, sulfuric acid, etc.) and nearly 20 raw materials (copper ore, sand, sulfur ore, etc.) was revealed.

Assessment of these SPS material requirements produced a number of potential materials supply problems. The more serious problems are those associated with the solar cell materials (gallium, gallium arsenide, sapphire, and solar grade silicon), and the graphite fiber required for the satellite structure and space construction facilities. In general, the gallium arsenide SPS option exhibits more serious problems than the silicon option, possibly because gallium arsenide technology is not as well developed as that for silicon.

The table on the next page summarizes potential material problems that have been identified. Problems of serious concern are denoted by an "A" in the table, and those of lesser but possible concern are denoted by a "B." The "A" materials are discussed briefly below. For more complete discussions including the "B" materials the reader is referred to the full report on this subject.⁽²⁾

As shown in the table, the gallium required for solar cells in the gallium arsenide option represents a potentially serious problem from a number of standpoints. It is a by-product of aluminum ore (bauxite) much of which is imported. It is also a high-cost material for which the SPS would be the primary consumer. This last problem could be alleviated if concurrent development of terrestrial photovoltaic programs or other uses for gallium emerged. However, this would also drive up the demand for what would be an already scarce commodity. The production of gallium arsenide is also a problem in that it would need to be greatly expanded and the SPS would again be the dominant consumer. Also, the arsenic and arsenic trioxide needed to produce gallium arsenide represent additional problems due to the weak position of the U.S. arsenic industry (only one plant in operation). Synthetic sapphire used as the substrate for gallium arsenide solar cells is extremely expensive. The SPS program would require major production expansion and would become the primary consumer.

The cost and energy requirements (electricity) associated with the production of solar grade silicon has been and remains a significant problem. In addition, the SPS again would dominate the market, unless parallel terrestrial photovoltaic programs or other applications for high purity silicon were developed. Additional demand would have less impact on silicon than on gallium since the raw material is plentiful. However, it would compound production growth rate problems for the high purity material.

SUMMARY OF ASSESSMENT RESULTS

PARAMETER	PERCENT SUPPLIED AS BY-PRODUCT	WORLD PRODUCTION GROWTH RATE	SPS PERCENT OF DEMAND	NET PERCENT IMPORTED	PERCENT WORLD RESOURCE CONSUMPTION	COST \$/KW
THRESHOLD VALUE *	50%	10%	10%	50%	200%	\$50/KW
Gallium	A	A	A	A		
Graphite Fiber		A	A			A
Sapphire		A	A			A
Silicon SEG		A	A			A
Gallium Arsenide		A	A			A
Electricity						A
Arsenic/Arsenic Trioxide	B			B		
Kapton		B	B			
Oxygen (liq)		B	B			
Silica Fiber		B	B			
Silver	B			B		
Silver ore				B	B	
Glass, borosil.			B			
Hydrogen (liq)		B				
Mercury				B		
Mercury ore				B		
Methane		B				
Petroleum						B
Steel						B
Tungsten				B		

Note: "A" signifies problem of serious concern
 "B" signifies problem of possible concern

*Parameter value above which a potential problem exists. Materials in this table exceeded these values where an "A" or "B" is recorded.

The production of photovoltaic materials requires large amounts of electrical energy. In the case of silicon the energy requirements are so large a silicon solar power satellite would need to operate at least five to six months just to generate enough electricity to make the amount of solar grade silicon used in its solar cells. For gallium arsenide the problem is less severe but possibly only because its defined production process is advanced state-of-the-art, while the silicon process is present or near-term state of the art. It is likely that the high dollar cost and high energy cost of solar materials is interrelated and when one problem is solved, so will the other.

The only problems of serious concern involving a material that appears in both SPS reference concepts are those associated with graphite fiber production. The production growth rate required to meet the combined requirements of the SPS and expected increased demand by the automobile industry could be in the 20-30 percent range sustained for a decade or more. Also, depending on the type of fiber selected, graphite fiber could become one of the highest material cost contributors to the SPS.

In all, potential problems were identified for some 20 SPS materials. Further investigations are needed to determine the severity and implications of these problems and to identify and define corrective actions. These investigations will need to consider factors such as the accuracy of resource and reserve estimates, improved raw material acquisition and beneficiation techniques, improved material production processes, materials acquisition/production economics (such as price/demand elasticity, capital investment requirements, and by-product/co-product economics), and strategies to alleviate import dependency. In addition, the SPS materials characterization (materials list) used in this study is incomplete and lacks adequate traceability. A more complete characterization is needed that would improve confidence in analysis results.

REFERENCES:

- (1) "Satellite Power System Concept Development and Evaluation Program," DOE/ER-0023, U.S. Department of Energy and the National Aeronautics and Space Administration, Washington, DC, October 28, 1978.
- (2) Teeter, R.R., and Jamieson, W.M., "Preliminary Materials Assessment for the Satellite Power System," DOE/ER-0038, Battelle Columbus Laboratories, Columbus, Ohio, January, 1980.

SOCIAL ACCEPTABILITY OF SATELLITE POWER SYSTEMS: A PRELIMINARY EXPLORATION

Stephen L. Klineberg

Department of Sociology - Rice University - Houston, Texas 77001

The U.S. Department of Energy is exploring several options for generating electrical power to meet future energy needs. One of these options is the Satellite Power System (SPS), a method of collecting solar energy in space for use in producing electricity on earth. In this early stage in the assessment of satellite power as a potential energy option, it is important to anticipate and explore as fully as possible those aspects of contemporary social change that may be expected to complicate the process of achieving the necessary support of the American public for this venture.

Energy policy is primarily a social and political issue, even more than an economic or technological one. Current patterns of public opinion make it appear unlikely that a strong consensus favoring heroic efforts to develop new energy supplies will emerge during the 1980s. The most recent polls indicate a major evolution in public attitudes along the following dimensions: (1) a shift away from the traditional faith in an unlimited future, toward a pervasive worry over inflation and a new economic pessimism; (2) a growing acceptance of the reality of energy shortages and of the vulnerability and precariousness of the country's energy situation; (3) a swift, sharp, and all-encompassing decline of trust and confidence in government and in major corporations; (4) a declining faith in the ability of science and technology to solve current problems of shortages and resources; (5) a broadening of aspirations to encompass nonmaterial "quality-of-life" concerns, making the traditional criteria of efficiency and goods-production less powerful and more relative; and (6) strong and broad-based commitments to environmental protection.

When concern about inflation and distrust of government and of major corporations combine with a commitment to environmental protection and a declining faith in science and technology, the resulting social environment is not particularly favorable for the support of a major new high-technology energy system such as the SPS. There is certain to be strong resistance to the high front-end development costs of the SPS program, to the further growth of the DOE/NASA bureaucracy that it implies, and to the strengthening of federal control over energy policy in the development of a highly exotic and potentially dangerous technology. More focused opposition to satellite power will come from those with vested interests in the long-run uses of coal, shale, nuclear breeders or fusion, and the development of on-site solar technologies. Even some space scientists will oppose the SPS out of fear that it might absorb all the capital and technology available for space, putting important small-scale projects in jeopardy.

All such opposition could be overcome by a broad-based conviction that the additional electricity the program would provide in the late 1990s and beyond will be sufficiently needed to justify the front-end costs and environmental risks associated with a project of this magnitude. If the 1980s should witness continued exponential growth in the U.S. demand for centralized electricity generation, the prospects of "selling" the SPS system to the American people as an important solution to serious impending energy

shortages would be significantly enhanced. There are compelling economic, technological, political, and social reasons, however, for anticipating instead a dramatic decline in the growth of U.S. energy demand during the closing decades of the twentieth century.

The quasi-universal assumption that a nation's vitality is to be measured by the growth in its energy consumption has been tempered by the recognition that the more expensive, imported energy the U.S. consumes, the weaker its economy becomes. The "wastefulness" in current consumption patterns is increasingly viewed as an opportunity to increase the efficiency of energy use. It will take time to turn over obsolete assets and to reorganize social patterns. There are distinct limits to what can be accomplished in the near term, but the direction in which American society is now moving is clear, and visions of future energy demand that are based on a projection of past trends are no longer believable.

Earth-based renewable-energy systems, in their various forms, seem destined to play an increasingly important role in the U.S. energy picture. Recognized as being particularly appropriate to the development needs of the labor-rich, village-dominated third-world countries, they are becoming the focus of growing interest in the U.S. as well. Their remarkable appeal reflects an evident desire on the part of many Americans to be more directly involved in meeting their own energy needs at the individual and local level, using technologies that they can understand and manage. Many fear that the high front-end costs of the SPS system will preempt less expensive alternatives, absorbing millions in R & D funds that are needed for the development of small-scale technologies and energy-storage systems.

The eventual near-term public response to the SPS concept does not now appear to be favorable. At a time when renewable energy systems are seen to promise more democratic and local control over energy supplies, satellite power would centralize solar electricity and perpetuate the monopoly control of the utility companies. In a period of declining faith in central governments, large corporations, big science, and esoteric technologies, the SPS program would further the growth of federal and corporate control over energy policy, in the development and deployment of some of the biggest and most impressive technologies of all. During the early years of difficult transition toward a much more diversified energy system, based on both depletable and renewable sources, in both large and small-scale systems, the SPS would concentrate what many perceive to be a disproportionate share of available capital in the pursuit of a single dramatic "solution." Most importantly, the predictable growth of conservation efforts and the spreading deployment of dispersed renewables suggest that the unmet U.S. demand for centrally generated electricity is unlikely to grow sufficiently to convince a reluctant public of the necessity for an investment of capital, material, and technological resources on the scale demanded by the SPS program. Satellite Power Systems will have a problem in the area of public acceptability.

ENERGY IMPLICATIONS OF AN AGING POPULATION

A.B. Cambel, G.A. Heffernan; The George Washington Univ., Washington, DC 20052
C.J. DeVita; Georgetown University, Washington, DC 20057

This study provides various demographic, medical and economic information relative to energy usage for a segment of the population -- the elderly -- which is growing in absolute numbers and also in relative population percentage. This growth is expected to continue well into the twenty-first century.

The U.S. aging population numbered 3.1 million in 1900, and by 1977 it had climbed to 23.5 million. It can be stated with reasonable certainty that this figure will rise to 31 million in the year 2000 and 43 million in the year 2020. These figures, corresponding to more than 10% of our population, are by no means insignificant.

As our fossil-fuel reserves are being depleted and the cost of energy mounts, it becomes apparent that the elderly will become increasingly vulnerable to the energy crisis, primarily because of physical tendency to infirmity, their economic and social situation, and the susceptibility to psychological depression. In some sense, it can be argued that the problem of the aged is little different from that of the rest of the population. However, there are certain subtleties that suggest that the energy problems faced by the elderly are not too different from those of the poor and the disabled.

This "white paper" concentrates, therefore, on those aspects of aging and the nation's energy problem which are not usually related in our everyday consideration of these as separable problems. It seeks to identify the peculiar energy problems of the aged and to consider alternatives in the solution of these problems, in light of modern technology.

The aging constitute an important constituency. This constituency has energy requirements similar to the rest of the population, but it also has distinct differences. For instance, in considering economics, the elderly are more likely to be disadvantaged and more likely to have to make the decision: heat versus food, medical care or quality of life concerns. Fifteen percent of the total elderly are classed as living in poverty, with those not living in families as bearing the heaviest burden, particularly those in the rural south. Our social structure presently takes account of economic disadvantages in the population. The structure is now and will in the future be called upon, increasingly, to include energy factors, such as a heating subsidy in this economic equation.

While elderly are being challenged economically, their medical problem is compounded by their energy needs and their relative lack of tolerance to energy deficiency. This manifests itself principally in their vulnerability to abnormal temperature environments. Thus, they tend to require a more even temperature, inferring specific energy demand, for which they may not have the requisite financial assets.

Perhaps the most interesting aspect of the elderly consideration is the question of demographics of the "over 65" segment of our population. In addition to the most striking statistic, mentioned above, that of gross numbers and percentages of elderly in the United States, other numbers representing the demographics of the elderly are impressive. Some of these nuances should prove interesting to energy planners. Recent figures show almost 50% more "over 65" females than males. The elderly are not concentrated in the sun belt, although there is a discernible trend of movement to the south and west. Percentage increases of elderly population from 1970-77 was more than double for the south and west over the northeast and north central. While elderly exhibit a low propensity to move, they seem to move locally or to the south and west when they do move.

Other demographic factors which may bear significantly on energy usage patterns of the elderly are:

- Urban/Non-Urban Mix;
- Living Arrangements; and
- Housing and Heating

These factors are all significant in the conclusions which may be drawn relative to the predominance of fossil fuel heating systems in use in homes of the elderly, the inferred insulation condition of this older housing and the efficiency of this arrangement as a total system.

The elderly are a unique constituency sharing certain characteristics of the poor and handicapped. They are a reasonably articulate group which will exert well-informed pressure for what they consider to be the needs of their group and the Nation as a whole. They are extremely concerned about the energy problem largely because of their medical and economic vulnerability. The combination of a weakening physical constitution; lower than average income; generally older, less energy efficient housing; living mostly in the city and, to a significant extent, nearly alone or completely alone leads to the conclusion that needs of this substantial, growing segment of our society must be afforded consideration as the social assessments of our alternative energy systems are proposed and developed.

AGE OF ELDERLY HOUSING 1973

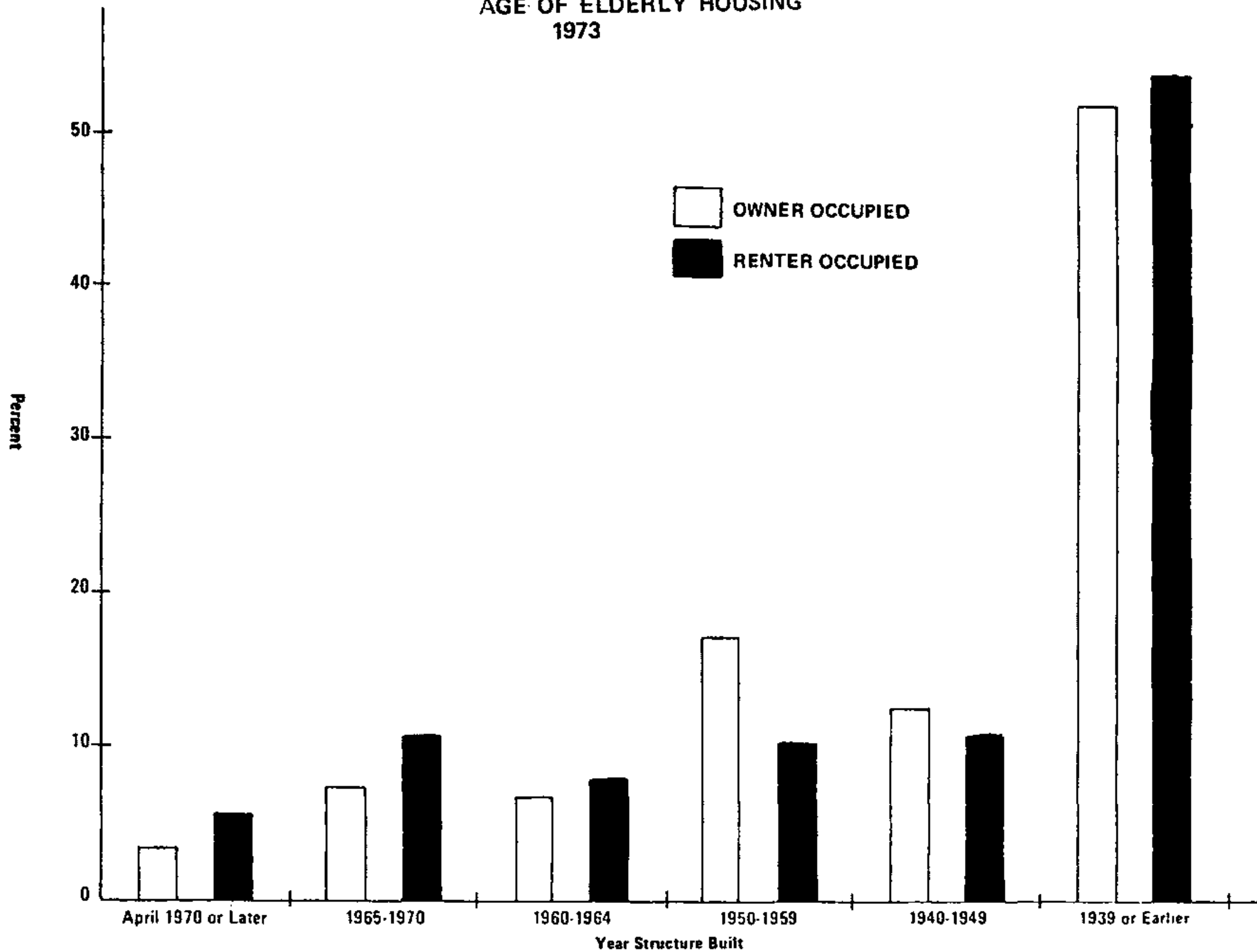

**ELDERLY INCOME
1976**

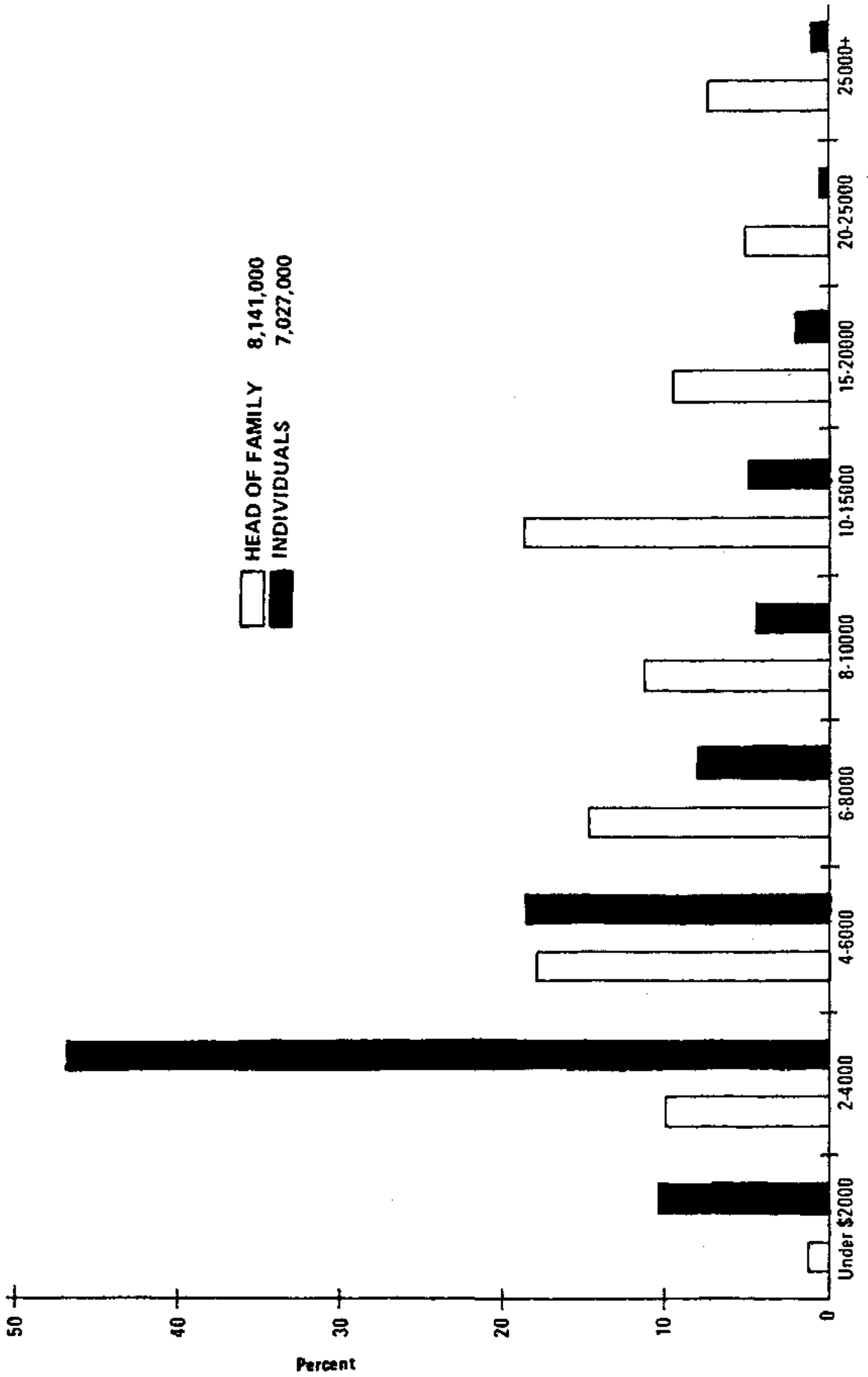

CONCERNS OF THE CITIZENS' ENERGY PROJECT ABOUT THE S.P.S.

Ken Bossong
Citizens' Energy Project

During 1979, the Citizens' Energy Project prepared summaries of 22 of the SPS "white papers" issued by the U.S. Department of Energy. The summaries were mailed to approximately 3,000 individuals and organizations including environmental & consumer groups, solar businesses & citizen groups, local government and public utility commission representatives, labor unions, alternative press contacts, and individuals interested in the SPS issue. In response to the request for comments on these summaries, 381 letters and other written comments were received as well as almost two dozen verbal comments.

Of the responses received, approximately 20 indicated support for the development of the SPS. Another 31 were neutral or undecided on the issue (i.e. generally felt that further study should be undertaken or that there was insufficient data yet on which to base a decision). The remaining responses indicated opposition towards the SPS concept; that opposition ranged in tone from a general sense that better energy options than the SPS existed up to a tone of total hostility to the SPS program. In total, the overall tenor of the comments received was negative towards the SPS.

The reasons for this opposition varied considerably. Among the concerns noted most frequently were those involving SPS's environmental, health, economic, centralization, and military impacts. Among the environmental impact issues noted most frequently were those associated with the use of microwaves to transmit SPS energy to the rectennas; that is, the microwaves could disrupt the ozone layer, earth-based communications systems, local ecosystems, and the like. Other environmental impacts that were noted by some respondents included the land use demands of the SPS both for the rectenna sites and the transmission line facilities. Others mentioned the difficulty or impossibility of recycling the materials used in the SPS construction as well as the heavy demand on some resources needed to build the SPS. Many persons also questioned whether the SPS or any of the lower earth orbit construction facilities could crash to earth "a la Skylab"; there was also some concern expressed about the noise, air, and water pollution impacts associated with a large number of rocket launches.

Among the health impact issues raised most frequently was the uncertain danger posed to human health by microwaves. This concern was expressed both in terms of the limited information now in hand on this point and on a general distrust of the use of a microwave beam. Respondents questioned whether the beam could wander or whether workers would be exposed to excessive job-related dangers. Interestingly, few comments were received on the health impacts of other aspects of the SPS program -- notably the health problems posed by working in space.

A very large number of persons objected to the SPS on the ground of its high economic cost. Repeatedly, respondents argued that the funds that would have to be spent on the SPS could be better invested in now-available, decentralized energy technologies (e.g. small wind systems, passive solar systems, energy conservation, etc.). There was also concern that an investment in the SPS would really be a case of putting too many eggs in a basket with an uncertain future. And some noted that the pricetag for the SPS would possibly drain funds from both other energy technologies as well as other government/private sector programs.

A surprisingly large number of persons submitting comments noted the potential military implications of the SPS. Some questioned whether the SPS was not just a thinly-disguised military program that would signal another escalation in the arms race; they suggested further that regardless of the intentions of the SPS program, it would be seen as a military threat by some nations and consequently prompt a new round of military weapons development. On the other side of the coin, some commenters suggested that the SPS would make a prime target for terrorists or saboteurs since it constituted such a large source of power.

The issue of centralization vs. decentralization emerged in several forms in the comments received. Some persons objected to an energy program that would necessitate the heavy involvement of the federal government and big businesses and the utility industry; this involvement was seen occurring at the expense of small businesses and individual communities. Others noted the problems of large energy development projects including those of cost over-runs, population disruptions, boom town effects, corruption, inefficiency, etc.

Some of the respondents raised other concerns as well. Among these points was the question of international cooperation; while many felt that such cooperation would be necessary, there was a noticeable split among the respondents as to whether this cooperation was desirable or even feasible. Other persons questioned whether it would be politically feasible to finance the SPS through increases in utility rates to current utility customers when the potential beneficiaries would be the customers of a future generation. And finally, some commenters noted that the SPS was an inefficient use of resources given that when fully operational, the satellites would only provide about 10% of the U.S.'s energy needs.

While strongly critical of the SPS technology in general, the overwhelming majority of the respondents expressed strong support for the outreach effort undertaken by the DOE to solicit public input on the issue. Interestingly, many respondents noted that they felt that the Citizens' Energy Project expressed a pro-SPS bias in its summaries of the DOE white papers; about an equal number stated that they felt that the Citizens' Energy Project exhibited an anti-SPS bias. In either event, there was a strong call for continued involvement by the general public in the process of evaluating the SPS program and its social environmental ramifications.

CONCERNS OF THE L-5 SOCIETY ABOUT SPS
Carolyn Henson - Annita Harlan - James C. Bennett
L-5 Society, 1620 North Park, Tucson, Arizona 85719

The L-5 Society is a pro-space citizens' group. It promotes space development in governmental, private and industrial sectors. Over the period of January 1979 through April 1980 it conducted a public outreach program on the Satellite Power System (SPS) for Planning Research Corporation (PRC).

As part of this outreach, the L-5 Society sent copies of PRC's and the Department of Energy's 1978 reports on various aspects of the SPS project to a core group of spokespeople for the pro-space constituency both in the U. S. and abroad. We conducted telephone interviews with these people as well as obtaining a number of in-depth written reports. The World Space Center, a project of the non-profit Sabre Foundation, assisted L-5 in this phase of the project.

The Society also mailed précis of these PRC and DOE reports to about 3,000 L-5 members around the world along with a form designed to get L-5 members' responses to the issues raised by these précis.

The message of the L-5 Society membership to DOE is:

- Solar power satellites look like a prime option for future energy needs
- Private enterprise will be interested in SPS
- The U. S. Government should have a supportive and regulatory hand in the project
- International involvement means complications for sure, but possible rewards for Earth as a whole
- The new Moon Treaty could severely inhibit use of extraterrestrial materials
- The Reference Design needs major revisions
- There's going to be Big Trouble if the environmental and social impacts are not calculated into the cost/benefit analysis for SPS development and deployment
- Earth resources should not be depleted
- SPS is a stepping stone to the stars
- If SPS is going to increase centralization of power, it had better provide big rewards such as clean, cheap power
- SPS have military implications. That's good, and that's bad.

The World Space Center participants' message to DOE is:

- The military implications of SPS are serious. A mechanism is needed to assure non-aggressive use
- National rivalries and international bureaucratization could become a major hindrance to SPS development
- Nations will cooperate in the development of SPS if they expect to share in its use and benefits. But if the benefits are restricted to

one nation or group of nations, strong opposition will spring up.

- International ownership of SPS is desirable. However, most respondents showed no strong preference for private international vs. governmental international ownership
- Environmental issues received mixed reactions. Some respondents were very concerned while others felt those issues would best be resolved by further study by experts
- Most respondents believed that resource requirements, rectenna siting, demographic impacts, public attitudes, public outreach and student participation were issues that would best be resolved by further study by experts.

CONCERNS OF FASST ABOUT THE SPS

Alan M. Ladwig

The Forum for the Advancement of Students in Science & Technology, Inc. (FASST)
1500 Massachusetts Ave., N.W., Suite 22 - Washington, D. C. 20005

The Forum participated in a public outreach experiment with two other organizations -- the Citizens' Energy Project and the L-5 Society. The selected outreach method consisted of sending 3,000 students and faculty members an "SPS Briefing Packet." The Packet included student-written summaries (in the FASST BRIEFING format) of 19 studies on the SPS reference system the societal assessment review, and the environmental, health and safety review. Also included in the Packet were a cover letter explaining the Public Review Program, a Response Form, and a postage-paid envelope for the Form. The Response Forms were then analyzed and categorized by the Forum. Questions raised by the participants were also categorized and passed on to the Department of Energy for answers.

As of December 15, 1979, 227 Response Forms were received by the Forum for a 7.5% return rate. Although this is below the 500 projected responses, additional Forms are expected during the second semester of the school year. Those who sent back their Response Forms included students, faculty and professionals in 41 states, from 130 academic institutions. Overall, the participants ranged in age from 14 to 71 (average age - 26) and represented 37 academic disciplines.

No clear majority of support or opposition to the SPS is evident from the returns. Many of the participants felt it was too early to give a definite opinion on SPS until more studies are completed. Of particular interest to the participants was the need for a thorough comparative assessment of the SPS to other energy technologies. A BRIEFING paper on the comparative assessment could have done a great deal to answer questions that were raised regarding how SPS research would affect terrestrial research, fusion research and conservation. The watch phrase seemed to be that we should not throw all of our funding into SPS research, but that it should be part of an overall research strategy.

In discussing the SPS reference system, the issue of vulnerability and control was often raised. There was much concern as to how well the SPS could stand up to either planned attacks from an enemy, or natural disasters. Many participants were critical of the reference system because there was no discussion of the use of lunar materials for construction of the satellite.

The problems associated with microwave transmission was the main environmental hazard mentioned in the Response Forms. Those participants who are most concerned about this area believe that the problems associated with microwave will be a major "show-stopper" to the entire project.

Among the societal implications of the SPS, the issue of centralization/decentralization generated numerous comments and questions from the participants. The primary concern stated was that a SPS concept would have to rely on a system similar to "big oil" companies and "utility monopolies."

While an earlier SPS study on "Prospective Organizational Structures" projected that the system would probably follow a national development model, most student participants endorsed an international structure for the SPS. While the participants did not overlook the degree of difficulty that would be involved to bring about an international agreement, they nonetheless feel it is vital if the SPS is to succeed.

Regardless of how the participants felt about the concept of the SPS, there was almost unanimous support for some form of public discussion on the issues related to this technology. In conjunction with this discussion was the belief that a vigorous public awareness program about the SPS should begin immediately. It was also suggested that similar discussions could take place with other DOE programs.

As illustrated in Figure 2, 61% of the participants mentioned that the FASST BRIEFINGS were their primary source of information on the SPS. Information from NASA and professional societies tied as the second most often mentioned source at 18%.

The Forum was encouraged by the evaluation of the BRIEFINGS as a method to involve and inform the campus community about the SPS concept. The suggestions for improvement that were submitted will be applied to future projects of this type. Of the participants who completed the evaluation, 51% gave the BRIEFINGS an "Excellent" rating as a means to inform the campus community about SPS. Those who felt the BRIEFINGS were a "Good" method numbered 34%, "Fair" ratings totaled 12%; and "Poor" ratings accounted for 3% of the participants. The ratings of the BRIEFINGS as a method to involve the campus community received a slightly lower evaluation. Of the participants who completed this part of the evaluation, 29% gave an "Excellent" rating; 45% marked "Good"; 25% felt the BRIEFINGS were a "Fair" method; and 4% of the ratings were marked "Poor."

The SPS Briefing Packet was just one of 17 methods for student involvement that has been suggested in an earlier study completed by the Forum. The results of this experiment support the need to implement additional methods in the discussion of emerging energy technologies. The method most often mentioned as a possible alternative by the participants is to employ projects which involve audio-visual presentations.

Throughout the Public Review Program, the Forum, Citizens' Energy Project and the L-5 Society sent participant questions to DOE for answers. These questions and answers will be published in booklet form and mailed back to the participants to close the communication loop. The mailing of this booklet is scheduled for late April 1980.

In the attached illustrations, the following abbreviations apply: HSS-High School Student; HSF-High School Faculty; JCS-Junior College Student; JCF-Junior College Faculty; CS-College Student; CF-College Faculty; NA/P-Non-academic/Professional.

FIGURE 1

PARTICIPANT'S AVERAGE AGE

	<u>HSS</u>	<u>HSF</u>	<u>JCS</u>	<u>JCF</u>	<u>CS</u>	<u>CF</u>	<u>NA/P</u>	<u>OVERALL</u>
AGE	16.9	38.2	20	49	22.5	53	31.1	26

ACADEMIC STANDING

	<u>HSS</u>	<u>HSF</u>	<u>JCS</u>	<u>JCF</u>	<u>CS</u>	<u>CF</u>	<u>NA/P</u>	<u>TOTAL</u>
FEMALE	3	1	2		24	5	4	39
MALE	22	5	3	3	100	35	20	188
TOTAL	25	6	5	3	124	40	24	227

AS A MEANS TO INFORM THE CAMPUS COMMUNITY ABOUT THE SPS CONCEPT, HOW WOULD YOU RATE THE SET OF FASST BRIEFINGS?

	<u>HSS</u>	<u>HSF</u>	<u>JCS</u>	<u>JCF</u>	<u>CS</u>	<u>CF</u>	<u>NA/P</u>	<u>TOTAL</u>
EXCELLENT	17	4	2	1	51	16	14	105
GOOD	5	2	1		39	14	8	69
FAIR	2		1	2	13	6	1	25
POOR			1		3	2		6
NO RESPONSE	1				18	2	1	22
TOTAL	25	6	5	3	124	40	24	227

AS A MEANS TO INVOLVE THE CAMPUS COMMUNITY ABOUT THE SPS CONCEPT, HOW WOULD YOU RATE THE SET OF FASST BRIEFINGS?

	<u>HSS</u>	<u>HSF</u>	<u>JCS</u>	<u>JCF</u>	<u>CS</u>	<u>CF</u>	<u>NA/P</u>	<u>TOTAL</u>
EXCELLENT	9	3	2	1	24	9	6	54
GOOD	11	1	2	1	54	9	13	91
FAIR	4	2	1	1	26	14	4	52
POOR					5	6		11
NO RESPONSE	1				15	2	1	19
TOTAL	25	6	5	3	124	40	24	227

FIGURE 2

ACADEMIC DISCIPLINE/OCCUPATION

Administrative Justice/Legal	3	Future Studies	5
Aerospace Engineering	16	General Studies	6
Anthropology	1	Geography	2
Astronomy	7	Health	2
Art	2	Industrial Education	2
Biology	13	Journalism	5
Business/Finance	11	Mathematics	1
Chemistry	12	Mechanical Engineering	7
Communications	7	Medicine	8
Computer Sciences	7	Philosophy	4
Economics	3	Physics	21
Education	2	Political Science	4
Electrical Engineering	13	Psychology	3
Engineering	6	Public Administration	2
English	3	Science/Society	8
Energy	2	Social Studies	3
Environmental Sciences	20	Space Sciences	9

PRIMARY SOURCE OF SPS INFORMATION

<u>SOURCE</u>	<u>HSS</u>	<u>HSF</u>	<u>JCS</u>	<u>JCF</u>	<u>CS</u>	<u>CF</u>	<u>NA/P</u>	<u>TOTAL</u>
NASA	10	3	1		16	3	8	41
DOE	1				8	1	3	13
CLASS			1		15		1	17
PRO. SOC.	2	1	1	1	20	9	7	41
PUB. INT.	3				9	4	4	20
NEWSPAPER	4	1	1	1	9	5		21
RADIO	1				1	1	2	5
TV	1			1	3		2	7
BRIEFINGS	21	2	3	2	86	19	7	140
OTHER:								
MAGAZINES	1				7	1	1	10
BOOKS					4			4
HEARINGS						2		2

A SOCIETAL ASSESSMENT OF STUDENT PARTICIPATION
IN THE EVALUATION OF THE SATELLITE POWER SYSTEM CONCEPT

Richard D. Wood

Aerospace Studies Department - Central Washington University

A satellite power system technology assessment was performed by a group of 15 senior aeronautics students at Central Washington University. The group was composed of two females, two Air Force ROTC students, one Marine Corps student, one Puerto Rican student, a student from Saudi Arabia, with the remaining students being from the Pacific Northwest or California.

What we shall attempt to do is summarize the material presented in the form of five group term papers prepared at the end of the technology assessment. Actual quotations, whenever possible, from the students' material have been utilized.

The bulk of the literature reviewed is that from the DOE/NASA satellite power system reports of October 1978 and the FASST review material prepared.

MICROWAVE RADIATION

As could probably be anticipated, the transmission of power from space to earth was one of primary concern, but note the rather unexpected comment. "Microwave radiation effects of SPS will become a more controversial issue, in the next few years, and once the issue starts to become confused, by the experts from both sides, public acceptance will become unlikely no matter what the experts find."

It was felt that perhaps the most important environmental factor associated with the SPS, as well as the one which the least is apparently known, is the change in climate and weather on a local regional scale as a result of the depositing of rocket effluents in the ionosphere. It has been indicated in the preliminary review study that the daily launches of the type of HLLV planned could result in continuous substantial reduction in the total ionosphere. "It certainly is of great concern to us since possible consequences could affect everyone on this planet and would not be confined to a small area." "We feel that with what is known at the present time there will be many barriers from an environmental point of view to a SPS system." "It is our opinion that a launch site outside the continental United States would have to be built in order to comply with the existing environmental standards." Offshore sites for the rectenna location and dedicated rectenna islands seem to make a more favorable impression.

LAND USE

Comments concerning land use, that SPS would require, is summarized in the following quotes: "It is very difficult to find a suitable site that does not violate at least one of the suggested criteria for selection. It is not difficult to believe that some of these criteria are either insignificant or overemphasized." "Local government land has been included in the category under universal exclusion. If this were the only barrier, to an otherwise ideal site, surely some sort of land sale, trade or lease agreement could be made. Additionally, it appears that if the need for such a receiving system were great enough, state and local regulations could be altered, eliminated or circumvented in order to complete the system."

PUBLIC HEALTH AND SAFETY FACTORS

"In comparing the proposed satellite power system to various alternative sources of power we have found many of the possible effects on the environment and public health and safety to be similar. Danger to the public, space and terrestrial workers, as a result of such things as manufacturing materials for SPS, transporting rocket fuels, launch and recovery, base construction problems, does not appear to be greater than the possibilities involved with nuclear, coal or oil."

The dangers associated with SPS will be to some extent unique, as in the case of space workers, but there appears to be a growing body of knowledge about how to handle most of the problems. "It is not the intention of this group to discourage implementation of a satellite power system, as we realize the importance of finding a practical power source to replace those dependent on non-renewable resources. It is of utmost concern, however, that there must be no limit to the thoroughness of research and development in assuring the public of an acceptable level of risk to health and safety with the least degradation of our environment. We must develop technologies that will not consistently destroy the quality of life while improving the quality of living. To quote Alfred North Whitehead, "When you understand all about the sun and all about the atmosphere and all about the revolution of the earth you may still miss the radiance of the sunset."

MILITARY IMPLICATIONS

"Luke Skywalker and Buck Rogers have landed! With increased military efforts on space warfare and technology the military implications of the solar power system are enormous and require in-depth study. It appears that the military potential of the SPS are very real." The areas probed by the Department of Defense study of military implications seems to touch only the surface of the strategic military iceberg. It appears that the military has the capability of using the satellite as a weapon in either the laser or microwave mode. The services, Army, Navy or Air Force are spending millions in the perfection of lasers capable of destroying missiles and drones and so forth at moderate ranges. "Further study of weapon use suggest that the particle beam weapons being currently developed by the Army and Navy under the code names 'SIPAPU' and 'CHAIR HERITAGE' respectively could be utilized on the SPS space platform as anti-satellite or anti-ballistic missile defense systems."

"The implications of the impacts on international relationships by military involvement with the SPS could be vast. Current space treaties do not cover systems like the SPS which could conceivably have an authorized defense system which could also be capable of an offensive mode." This could raise objections by other countries because of the psychological power of the SPS weapon. It would seem that a study is needed on how other countries would react to a SPS with military capability and how important the consequences of this reaction would be. The worth of having the military involved in the system should be analyzed." "Can the DOE and NASA, alone, financially handle the implications of the limitations of the SPS if produced without Department of Defense funds?"

"The relative vulnerability question of the SPS seems trivial at this time and

the attention should be focused on how the system can actually support and augment current military installations in the area of power, communications and surveillance." Military implications and concurrent applications require further study by DOE, NASA and DOD. "We should work together with political scientists to develop and adequately explain the inclusion OR omission of the military use of the SPS and the meaning to the American society."

PROGRAM COSTS

"The cost estimates certainly are not correct." "I quite imagine that if these things get to the construction stage the unions will take over rapidly." "The standards and quality of construction will require a degree of quality control that suggest that any statement of costs is apt to be vastly underestimated." A problem of real concern seems to lie in the apparent vested interest on both NASA and DOE's part to support the development of such a huge project. "Advocators of the project up to this point seem to be big science, big business, and the big bureaucracies."

PUBLIC ACCEPTANCE

"Public acceptability at all stages of the project is a must." This is because the public can band together in small interest groups and have tremendous influence to shut down or delay a project long enough to kill it. For this reason, the requirement of public acceptance should be directed more towards the interest groups than the everyday man on the street. "Even with the eventual solution of the technical and societal problems there is, in our opinion, only a marginal chance that the SPS system will receive public acceptance and approval unless the government undertakes a serious program to inform the public." What the government needs to do is to educate the public to the concept. "The public schools should be supplied with all of the information available regarding the SPS project, both pro and con." The information should be supplied in such a form as to make it easily understood by people having no prior knowledge of the SPS system. This program should be nationwide and should answer and explain many of the anticipated questions about the SPS. The program could begin by making available SPS pamphlets, similar to voters pamphlets. These pamphlets could present the basic concept and related information, followed by statements of concerns by various agencies and outside interest groups." We would like to add that the Federal Government needs to stress to the public that the United States, as a whole, is at a point where our monetary values can no longer be placed first. "They must be considered second to the development of new energy sources and face the fact that our supply of cheap energy is gone and that our present supply of energies are indeed exhaustible."

STUDENT PARTICIPATION

The Department of Energy has analyzed and evaluated seventeen different methods to increase student participation in the SPS project. These methods range from an instructor giving a class on the SPS, such as we are currently doing, to computerized satellite communications from NASA to colleges across the nation. Each method has a limiting factor which might not enhance its feasibility and a cost factor which could limit its application. "Today's high school education doesn't prepare an individual to be knowledgeable on current affairs that could play an important part in their future. Why not put less effort into teaching

history and instead teach the future or at least more current problems."

"Of over three hundred people questioned about SPS seventy percent had never heard of it." However, of the seventy percent all of them named solar power as one source of future power along with coal and nuclear. Students know the term "solar" but not the mechanics of producing solar power. After explaining the operation of the SPS in space and on the ground, the students next response was to ask how much power it would produce. When informed of the possible military uses of the SPS, most students stated that right now things could be over with the press of a button, so why the concern? For student participation to increase more effort should be made by the students that understand the SPS concept to inform others. A small amount of time given by people that understand the SPS could increase knowledge, acceptability, by many hundreds of percent. "It doesn't take much effort to inform students if you really feel they should know."

A STUDY OF FEDERAL MICROWAVE STANDARDS

Leonard David

PRC Energy Analysis Company - McLean, Virginia

A study has been made to identify the present and future federal regulatory processes which may impact the permissible levels of microwave radiation emitted by the SPS Microwave Power Transmission System (MPTS). The historical development and promulgation of U.S. occupational and public microwave "standards" is traced, evolving from reported bioeffects among military personnel operating radar equipment during World War II. Included is an overview of the philosophical variances between Eastern and Western countries which have resulted in world-wide permissible exposures to microwaves that differ by four orders of magnitude. For the United States, and a majority of Western countries, the concept of risk/benefit criterion has been accepted, involving use of an adequate safety margin below a known threshold of hazard. Soviet and most East European microwave standards on the other hand, are based on a "no-effect" philosophy--all deviations from normal are hazardous. Yet to be determined, however, are definitions of what connotes a "hazard" or "adequate" safety margin in terms of microwave exposure.

Agencies currently with microwave regulatory responsibilities are: the FDA for protecting the public from potential health hazards of electronic products that emit radiation; the OSHA for regulating radiation levels in the workplace; and the EPA which develops federal guidance concerning radiation levels in the environment, including public exposure. The intrinsic nature of SPS and its MPTS cuts across numerous agency jurisdictions and regulatory authorities. At this time no single interface is available for SPS development, implementation, and commercialization regarding production of rf energy by the SPS MPTS. However, the recently formed Federal Council on Radiation Policy, chaired by the Administrator of EPA, could ostensibly untangle agency jurisdictional overlap and the various regulations which will effect the SPS MPTS. The Council will involve 12 federal agencies, providing a forum for creating radiation policy, both ionizing and nonionizing, including the review of radiation monitoring and protection responsibilities of government agencies. A trend toward stricter controls on activities perceived harmful to public health is observed, as in interest in improving the federal regulatory process. A possible convergence of microwave standards worldwide is characterized by a lowering of Western exposure levels while Eastern countries consider standard relaxation. Particularly relevant to SPS is the initiation of long-term, low-level microwave exposure programs. Coupled with new developments in instrumentation and dosimetry, the results from chronic exposure programs and population exposure studies could be expected within the next five to ten years. Noted is the increasing public concern that rf energy is yet another hazardous environmental agent. In the absence of definitive scientific data on electromagnetic bioeffects, both thermal and non-thermal, public apprehension can be expected to grow.

The entire federal regulatory process is presently under review, aimed at streamlining and improving the system. In particular, a bill (S.1938) is now before the Senate calling for effective coordination among the various federal agencies involved in radiation protection. Central to the bill is establishment of a Federal Council on Radiation Protection, with the Administrator of EPA as chairman.

A future trend in the regulatory process involves increased public participation in rulemaking proceedings. Proposed legislation seeks to increase the level of funding for agency public participation programs. "Intervenor funding" is also proposed which would pay for public interest participation. The payment of witnesses to represent the public interest is in response to some concerns that only corporations or public interest groups can afford lobbying efforts.

This increase in public participation could have negative and positive effects on SPS planning. Public awareness and concern over microwave radiation is steadily increasing, as noted by studies on SPS public acceptance. Environmental groups and public coalitions have already taken issue with the development of projects involving nonionizing radiation, e.g., Sanguine/Seafarer, Pave Paws, and microwave communication towers. The lack of conclusive data regarding low-dose, long-term effects of microwaves on the human could emulate public concerns and response to nuclear power.

The very terminology, microwave radiation, may confuse the public; the difference between nonionizing and ionizing may be misunderstood, leading to general citizen apprehension of the term radiation. This apprehension could be vented through public participation in the federal regulatory process. Conversely, pro-SPS space advocates, of course, would utilize these participatory channels as well.

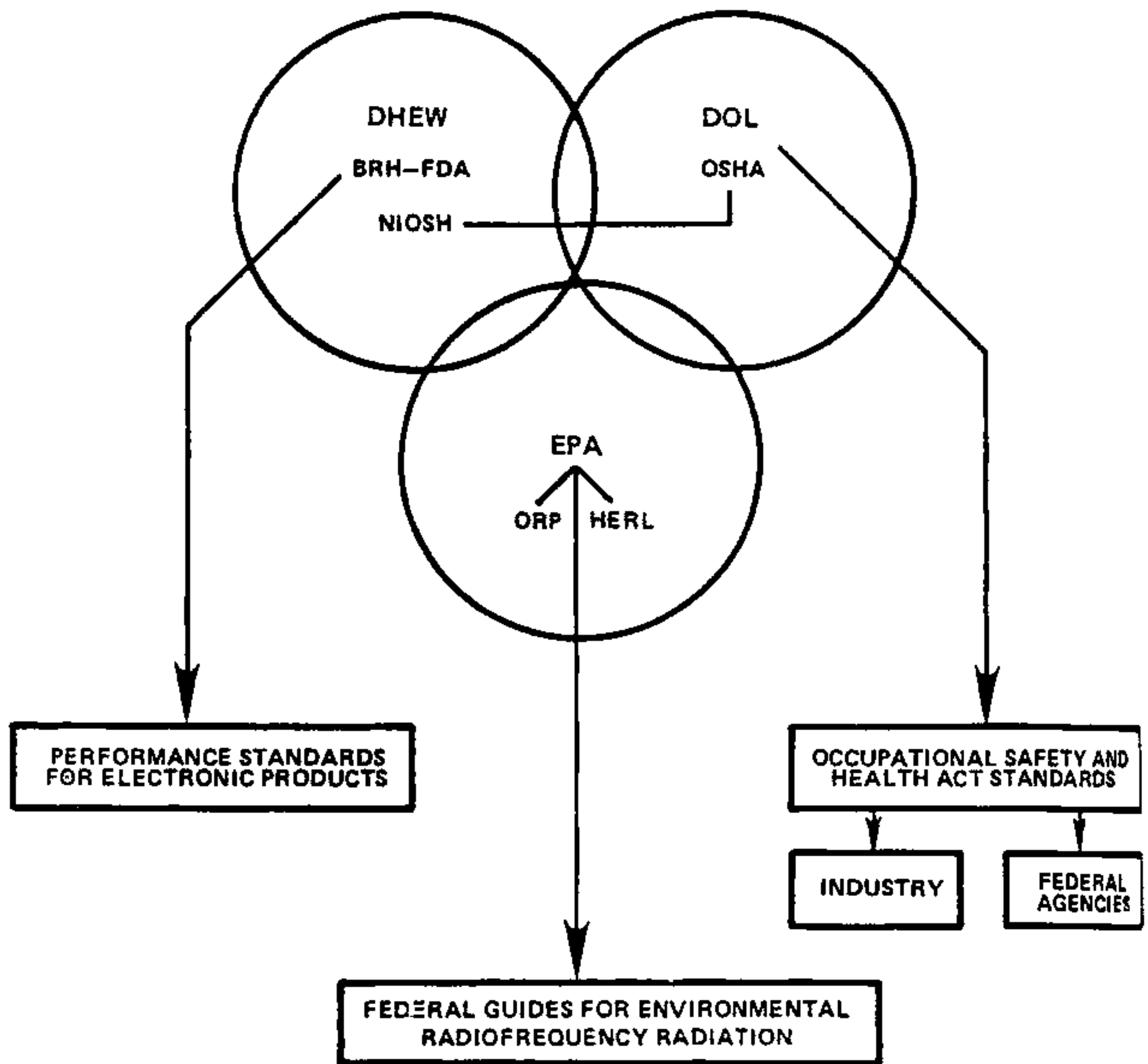

- BRH · Bureau of Radiological Health
- DHEW · Department of Health, Education and Welfare
- DOL · Department of Labor
- EPA · Environmental Protection Agency
- FDA · Food and Drug Administration
- HERL · Health Effects Research Laboratory
- NIOSH · National Institute of Occupational Safety and Health
- ORP · Office of Radiation Programs
- OSHA · Occupational Safety and Health Administration

Source: David Janes, Jr., The EPA Environmental Radiofrequency Program: Present Status and Environmental Findings, October 14, 1978.

Federal Agencies With Microwave Regulatory Responsibilities

SATELLITE POWER SYSTEM: INITIAL INSURANCE EVALUATION

William Lloyd
Marsh and McLennon, Inc.

If realized, the Satellite Power System will present a substantial economic risk to the International Agency or Consortium managing its development and use. The solution to unavoidable economic risk is insurance. Insurance has been written for the in-orbit performance of satellite systems, including launch. An insurance evaluation of the SPS, both in its in-orbit and ground aspects is presented. The history of spacecraft insurance, the prime economic risks foreseen for the SPS, and the proportion of these risks the world insurance market might be willing to underwrite are considered.

[Extended Abstract Not Received]

PROBLEMS AND PROSPECTS FOR AN SPS ROLE IN NEW YORK STATE'S ENERGY FUTURE:
A MAJOR CASE STUDY OF CONCEPT VIABILITY

R. Sviedrys, D. McHugh and G. Homatas

Polytechnic Institute of New York - Brooklyn, New York 11201

Whether viewed from a regional, national, or global perspective, the characteristics of NYS are unique in terms of load density and siting problems. The Northeast, and especially NYS, constitute the US region most dependent on imported oil. In 1978, 66.3% of NYS primary energy consumption was oil, compared to 45.4% nationally. Electrical generation was 45.0% oil dependent versus only 16.6% for the nation. With over 90% of all energy imported, NYS has to sustain heavy cash outflows to other states or nations. Yet despite economic slump and lagging population growth, NYS continues to be at the center of the largest load area in the most electrically developed section of the nation. The State has traditionally been in the forefront for SPS-related or analogous fields, most significantly, Indian Head, the first US commercial nuclear plant. In the light of such precedents, will NYS be in the forefront of SPS developments? If not, why not? Clearly, NYS and its power pool (NYPP) represent an electric consumption market whose requirements and constraints should play a significant role in shaping and evaluating any new, major baseload system such as SPS. Nonetheless, contacts with various relevant NYS authorities responsible for planning, R&D or regulation has indicated a highly inadequate cognizance of the SPS system, evaluation program, and related issues. Without early participation of such policy strata, unnecessary mistakes and conflicts analogous to those now suffered by nuclear programs are not likely to be avoided.

As of 1980, justification for all future generation planning and siting — SPS or other — must conform to the load ceilings and other constraints determined under the State's new "comprehensive and integrated" Energy Master Plan (EMP) which establishes a "binding" framework of accepted growth over a 15-year time span, subject to approval by an Energy Board (EB) of 5 top officials. Subsuming all previous procedures, the EMP constitutes a new layer of decision in an already tardy process, and may remove much discretion from the traditional planning community. Hence the EMP's governing philosophy is more subject to capture by anti-growth factions. Discussions with EMP participants indicated that none perceived that any meaningful aspects of the SPS program fell within even the 15-year legal planning horizon, the 10-year project span, the 5-year R&D orientation or the regulatory rate year. Further, R&D officials (NYSERDA) indicated skepticism as to the compatibility of the SPS with their "Alternate Technology" (AT) legislative mandate. The novel microwave issue will require an additional layer of regulatory screening, the responsibility for which has not yet been formulated much less assigned. SPS discussions face an aversive public environment, currently running strongly against even contemporary 1 GW scale plants. Just in the past year, 4 nuclear sites have been cancelled. Coal options and conversions are under severe scrutiny by advocates of decentralized AT options such as low-head hydro, cogeneration, and "renewables." Yet specific AT proposals such as MSW energy recovery are stalled, often due to the "not in my backyard" syndrome. A succession of historically unique, drastic scale downs of long range forecasts of load requirements for NYS, coupled with factors such as the current easy availability of cheap but politically unreliable Quebec hydropower, has enabled NYS authorities to defer hard decisions on centralized generation installments.

Projections have been progressively slashed from the pre-1973, 5.8%/yr down to a currently accepted 1.9% (NYS EB). The result has been a reduction by more

than half in the 1995 load demand projection from 57 GW (1974) down to 28 GW (1980). The EB projection is bounded by higher and lower ones from other contributors. The State Senate Designee stated that 2.5%/year growth was the minimum necessary to avoid the "self-fulfilling prophecy" of economic stagnation and shortfalls in capacity with respect to future opportunities such as the electric car or the solar-assisted heat pump. The low-growth oriented Sierra Club claimed that 1.1% growth would be adequate and even entertained a possible 0.4%. Clearly even a modest divergence between actual growth and any of these very conservative scenarios, would result in a growing "generation gap" requiring a "catch up" program just as the SPS option emerges. By that time additions of even currently "acceptable" coal systems may be difficult as CO₂ and acid rain problems intensify. The gap between the EB and the Legislature's projections could accommodate at least 1 SPS by 2010 and 3 SPS scale units by 2030. More optimistic growth means even larger gaps, requiring significant planning within the 15-year EMP horizon. NYPP would have sufficient reserves and interconnects for 1 SPS unit, but the only financial institution of adequate scale, the proposed ENCONO, has failed, as yet, to achieve acceptance.

Given these problems and opportunities, the SPS program should be elaborated so that emerging features are perceived by state authorities to reflect benefits into their time frames and areas of concern. A prime missed opportunity was the failure of the SPS CDEP to develop the potential of rectenna "dual use" as an advanced biomass production site, whether land or water based. Incremental development of candidate sites for biomass, but designed to have maximum infrastructural dualities for a future rectenna, would be more responsive to local needs and assimilative capacity than a sudden "boom town" deployment. The first such "Sunplex" might be gradually evolved at federally owned Ft. Drum. Further, the exclusion of Great Lakes siting in preference for more highly problematical land siting, should be reconsidered. Expansion of Sunplex designs around existing generation nodes, such as Nine Mile Point on Lake Ontario or the Lake Erie coal station, would be more compatible with the current planning environment and with the acceleration of existing NYSERDA biomass goals. In addition, alternate rationales for securing public and official support should be developed and highlighted, namely: multiplier and spin-off effects on the ailing NYS aerospace industry in the near as well as far term; SPS "by wire" options which might also reduce acid rain from adjacent states or free up coal, nuclear or other resources for NYS. Perhaps the greatest opportunity of the early phases of SPS evaluation would be the development of new policy analysis tools which are more appropriate to decision modeling of the actual nonlinear, nonequilibrium, historical succession patterns of the "long wave" evolution of major social infrastructure (especially energy-related systems) than are the existing screening techniques which incorporate such methods as present value discounting, linear cost-benefit analysis, reversible equilibrium biased econometrics, and Malthusian epistemologies. Issues, such as the extent to which local decentralization is really just a euphemism for peripheralization relative to the hyperbolically advancing "growth poles" of the world economy, may then be competently addressed and weighed in energy planning.

SATELLITE POWER SYSTEMS (SPS): THE NEED FOR A DETAILED ASSESSMENT
TO DEVELOP FEASIBLE MANAGEMENT SCHEMES

Michael S. Kaplan

Physical Science Policy Analyst - Program Analysis Division

U. S. General Accounting Office - 441 G Street NW, Rm. 5037, Washington, D.C. 20548
(202) 275-1551

Disclaimer:

*This paper reflects personal views, not necessarily those of
the U. S. General Accounting Office*

The Satellite Power System (SPS), a concept which is currently under review by the Department of Energy (DOE) and the National Aeronautics and Space Administration (NASA), represents a new technology which could be available to supply a fraction of our country's energy needs by the early portion of the next century. Studies conducted by the U. S. General Accounting Office often raise the issue of the capability of program management to effectively manage a very large program. Preliminary assessments by both DOE and NASA indicate that the SPS program could be among the most massive and complex initiatives ever undertaken. Besides presenting a variety of technical challenges to our nation's scientists and engineers, the SPS program's enormous costs (dollars and labor) and impacts require us to go beyond considering the concept's technical, environmental, economic, and social feasibility.

Many institutional and organizational obstacles exist which will have to be overcome for the SPS program to be a success (Figure 1). To grasp the enormity of the task of constructing a satellite solar power station, it is informative to compare the SPS program to one of the nation's most impressive achievements in high-technology -- Project Apollo. The Apollo program involved the expenditure of \$20 billion over a ten year period while involving 80 nations and employing some 400,000 people at over 20,000 industrial concerns and 200 universities. The success of Project Apollo was the direct result of extraordinary technical effort coupled with revolutionary methods in program management. In both the planning and in the integration and control of the Apollo program, management's effectiveness in dealing effectively with complexity was truly remarkable. Thus if we are to believe that the SPS program can represent a viable source of energy for the US by the 21st Century, we must realize that new breakthroughs are needed in very large program management. This is a consequence of the belief that the SPS program will be at least an order of magnitude larger and several orders of magnitude more complex than the Apollo program.

Because of our lack of experience in managing such a large and complex program as SPS, we must develop radically different management concepts to support the program. Cybernetics, the science of communication and control, can play a major role in the assessment of both the adequacy of current managerial approaches and techniques as well as assist in the design and development of new potential organizational structures and institutional relationships (Figure 2). Use of cybernetics allows us to conduct technological programs which are extremely complex by designing metaorganizational structures. Of particular importance is the potential for cybernetics to assist in the design of "meta-systems" that can adapt to a dynamic and complex environment while retaining their desire and capability to progress toward some predefined goal and/or objective. Hence, more detailed study of potential SPS management structures

using cybernetic approaches should be incorporated into future SPS program assessments. To commence the SPS program without suitable organizational concepts for a feasible management structure would seem to doom such a large and potentially very useful program to failure.

Figure 1.

Some Institutional/Organizational Issues
and Barriers to the SPS Program

DETERMINATION OF APPROPRIATE PUBLIC SECTOR/PRIVATE SECTOR
ROLES AND RESPONSIBILITIES

NEED TO IMPROVE NATIONAL STRATEGIC PLANNING FOR ENERGY
PRODUCTION

DEFINITION OF APPROPRIATE DEGREES OF RISK IN ESTABLISHING
REGULATIONS IMPACTING SPS CONSTRUCTION AND OPERATION

CONSIDERATION OF TRADEOFFS BETWEEN PROTECTIONISM AND TECHNOL-
OGICAL ASSISTANCE IN FOSTERING INTERNATIONAL COOPERATION
AND PARTICIPATION

LACK OF FUTURE OBJECTIVES AND STRATEGY FOR THE US SPACE PROGRAM

NEED TO IMPROVE INTERAGENCY COORDINATION AND COOPERATION

FUTURE FOCUS OF TECHNOLOGICAL EFFORTS: LARGE-SCALE/CENTRALIZED
TECHNOLOGIES VS. SMALL-SCALE/DECENTRALIZED TECHNOLOGIES

DEVELOPMENT OF FUNDING MECHANISMS TO SUPPORT THE SPS PROGRAM

Figure 2.

Potential Contributions of Cybernetics
to SPS Program Management

ABILITY TO DESIGN A METAORGANIZATIONAL ENTITY WHICH IS CAPABLE OF

- SENSING CHANGES IN THE ENVIRONMENT
- TRANSLATING AND TRANSMITTING THOSE ENVIRONMENTAL CHANGES
TO THE PROPER ORGANIZATIONAL ENTITY
- ASSESSING THE IMPACT OF CHANGES IN THE ENVIRONMENT ON THE
ABILITY OF THE PROGRAM TO PROGRESS TOWARD IT'S ULTIMATE
GOAL
- RESPONDING TO CHANGE BY MODIFYING INTERRELATIONSHIPS
AMONG ORGANIZATIONS WITHIN THE PROGRAM

GOVERNMENT REGULATIONS CAN BE CONSIDERED AS CONSTRAINTS ON A

CYBERNETIC MODEL OF PROGRAM MANAGEMENT TO ASSESS IMPACTS
ABILITY TO MANAGE CHANGE THROUGH INTERNAL REORGANIZATION RATHER
THAN THROUGH CHANGING INPUTS TO THE PROGRAM

SOME JUDICIAL AND REGULATORY FACTORS
S. L. Entres
General Technology Systems Ltd.

Recently, General Technology Systems Ltd. carried out, on behalf of the UK Department of Industry, a study of the future industrialization of space. The major effort was devoted to Space Power Systems (SPS). This particular part of the study was based largely on a search and critical evaluation of published information, mainly of US origin and available up to the end of 1978

This independent assessment of SPS technology and application has resulted in a number of major conclusions. Three factors clearly spoke in favor of SPS: (i) the technological assessment indicated that the SPS concept is technically entirely feasible as an engineering project; (ii) the economic assessment has suggested (though less optimistically than those presented in some published papers) that electricity could be technically produced by means of SPS at a sensible cost; there were no indications that the resulting electricity prices could not be competitive in the context of base load electricity supply after the turn of the century; (iii) the amount of solar power collectable through interception of power stations orbiting up to the geostationary distance is substantial and could make a welcome contribution to the energy requirements not only by regional, but also by global standards.

The investigation has, however, clearly shown that the ultimate practicability of a wide use of SPS depends crucially on a range of factors which exceed in importance by far the mere concept of SPS technology in question. Foremost among those factors are:

- (i) The ready availability of construction materials and consumables needed for SPS which must, for economic reasons, be introduced on a massive scale;
- (ii) The availability of formidable facilities for the corresponding space transport of man and cargo as well as the acquisition of permits for the required flight routes;
- (iii) The deployment in space of industrial personnel in large numbers;
- (iv) The environmental hazards created by SPS operation and, especially, the not inconsiderable hazards created by heavy space transport schedules during periods of construction;
- (v) The need for massive financing over relatively short periods of time;
- (vi) Gaining access to large land or sea areas needed for the reception of the transmitted electromagnetic energy;
- (vii) The pressures which will be exerted by non-energy interests to utilize SPS platforms for multi-function duties, particularly in view of the likely multi-national character of SPS projects;
- (viii) The complex issues which would arise in a partnership, say, between, on the one hand, Europe with a worthwhile industrial potential relevant to SPS technology but with an inadequate technical infra-structure for the corresponding field of heavy space transport and, on the other hand, a partner that is competent in both these areas.

Aspects such as the above (and the list is by no means exhaustive) point to the increased complexity in the approach needed for the provision of space power systems compared with, say, terrestrial types of electricity generating stations which can be provided on an individual, traditional, national basis by sovereign states.

This complexity will be reflected by the types and magnitudes of legal, political and institutional issues which will emerge. It is widely held that the serious promoter of an SPS project will find the juridical ground for his actions inadequately prepared, largely for two reasons: The application of SPS technology will have novel, substantial and world-wide implications and the corresponding industrial activity in space will be on a scale which is without precedent. Of course, if the acquisition of space solar power should become a matter of vital importance to the technologically advanced user he may choose not to wait until such issues have been resolved.

Important political, legal, regulator and institutional issues arise in five areas:

- (i) Access to resources (e.g. materials, real estate for rec-tennas, orbits);
- (ii) Environmental impacts (e.g. launch pollution, electromagnetic power waves, change of land use, rocket noise);
- (iii) Industrial operations in outer space (e.g. procedures for working in space, space traffic regulation, safety in space);
- (iv) liability (e.g. catastrophic launch failures, damage through space debris);
- (v) Organization (involvement of many existing international and national official bodies and creation of specific institutions not only for SPS project management and operation but but also for purposes such as policing of space).

None of the non-technological issues bearing on the ultimate practicability of the large scale use of SPS seem to be insurmountable but much time is needed for defining such issues and for finding agreed solutions. Equally of course, much time is needed in finding cost-effective engineering solutions in order to make SPS a competitive supplier of base load electricity.

A DIFFERENT RACE
Raymond S. Leonard, P.E. - Consulting Engineer
1232 Date Street, Montara, California

The Satellite Power System Program could be the vehicle used for solving three of our nation's major problems: energy, strategic defense, and the lack of a national purpose and challenge.

In the energy sector the problem is to discover how this nation can obtain electric power, energy for space and processing heating, and the transportation fuels it needs at a reasonable price, from a secure source, and by methods which minimize environmental problems such as waste disposal, thermal pollution, air pollution, and disruption of terrain.

In the strategic defense sector the problem is not what or how many new offensive strategic weapon systems to deploy but rather to determine and deploy the best systems to economically provide deterrence or defense against a nuclear attack economically for a consumer oriented society that is seeking to give to itself more and more social services.

No nation, including the United States, can remain strong and disciplined as a people without some sense of purpose. The question is to determine the new sense of purpose that can rally our people.

For approximately the same amount of money that this nation is planning to spend on deploying the MX missile, we can build a space industrial facility which will produce power plants, allow for cheap communications systems, and provide nationwide defense against ballistic missile attack. Through the use of hydrogen produced from SPS electricity we can also supply all the fuel we may ever need for transportation purposes.

The Different Race Concept: Instead of trying to compete with the Russians or any other adversary on the basis of who can produce the most missiles or tanks, we need to make the effort to change the contest to one which emphasizes the best qualities of the United States: respect for the individual, free enterprise in a relatively free market, and surpluses from a productive society allowed us to successfully aid those less fortunate without robbing the wage earner. This policy was successful during the late 60s and early 70s (the era of Apollo); the U.S. was preeminent in space and had a vigorous economy. During that time there was some effort on the part of the Soviets to foster detente. When our loss of commitment was realized detente collapsed.

An aggressive space program whose goal is energy independence for not only the United States but also the world, develops capital facilities and has both hard military applications in an indirect sense, and promotes peace by stimulating a desire on the part of our adversaries to work with us in order to gain access to the technology and benefits of such a program. Large new strategic weapons systems cannot do both of the tasks.

Technical Feasibility: It is technically feasible to build a space industrial complex and satellite power systems, as well as introduce a hydrogen fuel economy with manned early warning space stations and a laser antiballistic missile defense system. A brief review of the technical literature will confirm this statement.

Economic Competitiveness of the Proposal: When this proposed program is compared to the costs and the requirements for implementing either a nuclear or coal option for solving the energy problem, it is found that a Satellite Power System/Hydrogen Fuel Economy is more than competitive. In addition the competitive advantage of SPS/HFE improves with time.

When the original costs associated with building the space construction facility or geosynchronous space industrial complex is compared with previous large capital programs such as the Panama Canal and Apollo it is seen that the financial commitment required is not large.

Strategic Considerations: There are at least three direct strategic benefits, all of which are passive or defensive so that the emphasis is on a desire for peace: manned early warning facilities, improved hardened space communications relay systems, and a space-based anti-ballistic missile defense system.

Secondary strategic benefits occur because of the ability to deploy giant airships for use in protecting our fleets, the possibility and desirability of a nuclear merchant marine. These possibilities and many others are possible because of resource substitution, and the accessibility of the resources to the universe (or at least the solar system) instead of only our finite world.

National Goals: Since we don't have a national goal which transcends our every day concerns, a space program aimed at solving our energy problems and our need to improve our ability to defend our nation in a peaceful way would provide such a goal.

Secondary Benefits: A number of very important secondary benefits for the country will develop if we pursue the course outlined in this paper, such as reduced pollution, cheaper products due to lessened demand for hydrocarbons for burning, and the ability to retain our mobility.

Environmental Factors: In all areas of environmental concerns the Satellite Power System/Hydrogen Fuel Economy program either has a much less impact on the environment than other options or its implementation will solve problems such as the air pollution in the Los Angeles Basin and acid rain due to increased burning of coal.

Conclusions: The proposal to build a space industrial complex, produce Satellite Power Systems, and implement a Hydrogen Fuel Economy is technically feasible, economically competitive with other alternatives, and environmentally acceptable. In addition, the effort is worthwhile from the standpoint of maintaining a belief that this nation is committed to moving forward and providing the resources needed for its population to realize its aspirations.

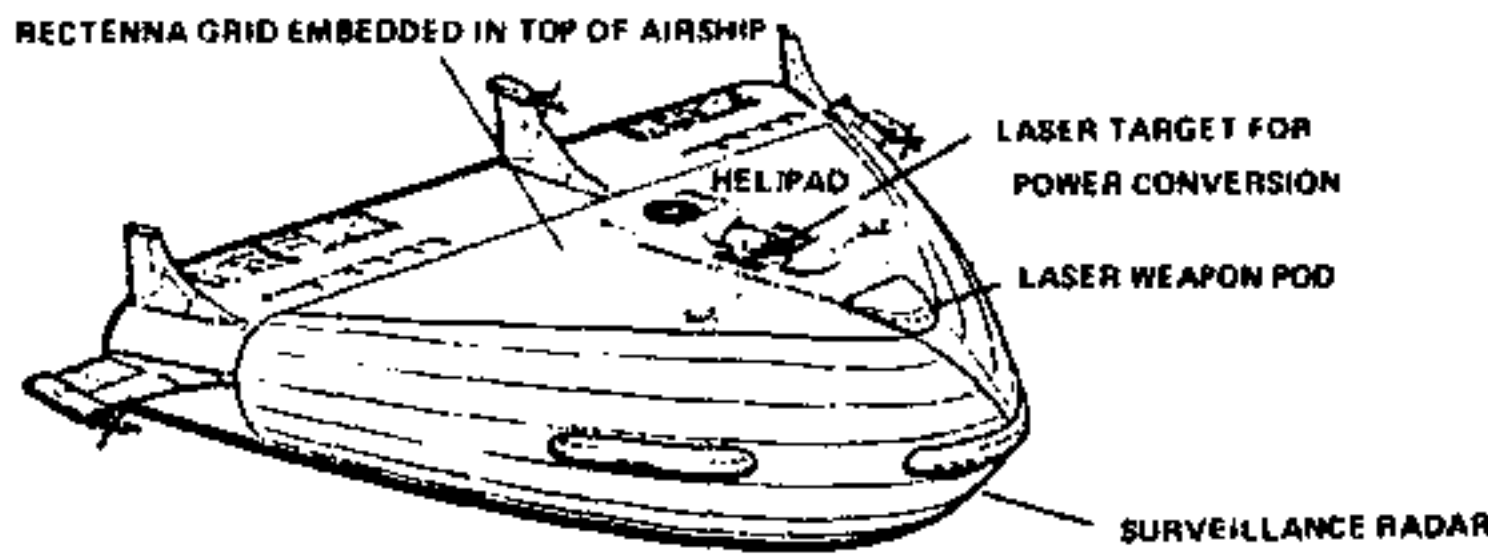

AIRSHIP DESIGN FROM REFERENCE 205

VOLUME : 26 million cubic feet
 PAYLOAD : 900,000 pounds
 OPERATING ALTITUDE : 20 to 40 thousand feet

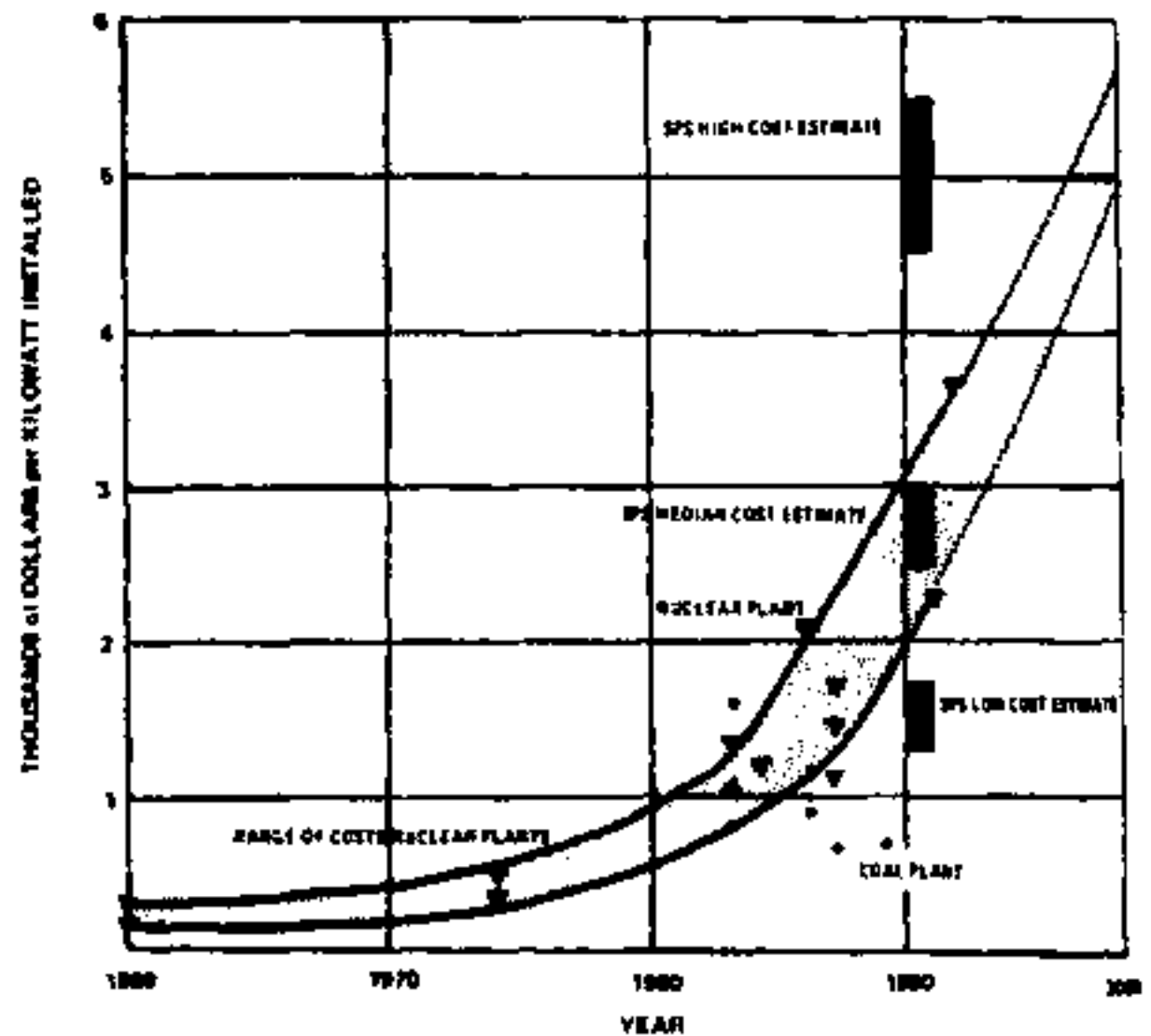

COST OF BUILDING LARGE ELECTRIC GENERATING STATIONS

PROJECT	Original Cost Millions	Period of Construction Years	Average Rate of Expenditure Dollars	Cost in 1976 Dollars	Revenue Producing	Percent of GNP at time of Project
Louisiana Purchase (1803)	0.023	N/A	7	7	YES	7.85 (1976)
Trans-Continental Railroad (1864-1870)	0.050	6	7	7	YES	106 (1976)
Alaska Purchase (1867)	0.007	N/A	7	7	YES	491 (1976)
Panama Canal	0.32	16	0.02	7	YES	6.19
Manhattan Project ¹	2.0	5	0.40	6.33/11.54	NO	6.44 to 8.5
Apollo ²	20 to 40	9	2.22 to 4.44	38 to 76	NO	>15
Alaska Pipeline	10.0	10	1.0	N/A	YES	>15
WE Hawaii	30 to 40	10	3.0 to 4.0	N/A	NO	>15
Development of Satellite Power System ³	40 to 50	10 to 15	2.67 to 5.0	N/A	YES	>15

TABLE 2 COMPARISONS OF MAJOR ACQUISITIONS OR PROJECTS UNDERTAKEN BY THE UNITED STATES DURING THE PAST 200 YEARS

1. Escalated Manhattan Project Costs Compared Price Index/Licensee per capita income
2. Escalated Apollo Project Costs Compared Price Index
3. Development time and cost includes bringing the first power station on line
4. Federal Budget Expenditures for the year in question millions

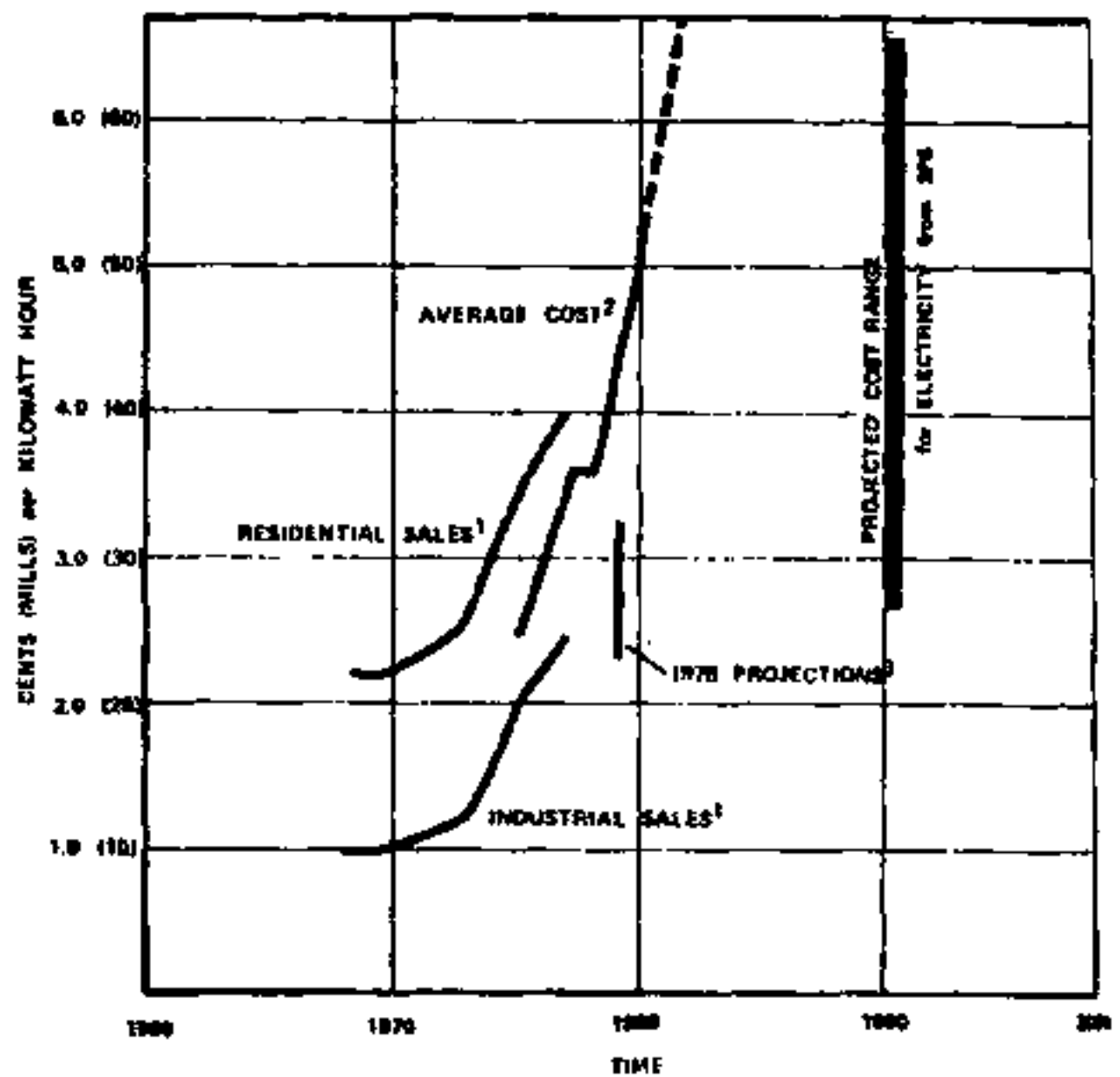

COST OF ELECTRICITY PAST, PRESENT & FUTURE

- 1 from reference 15
- 2 from reference 16
- 3 from reference 17
- 4 from reference 18, 19

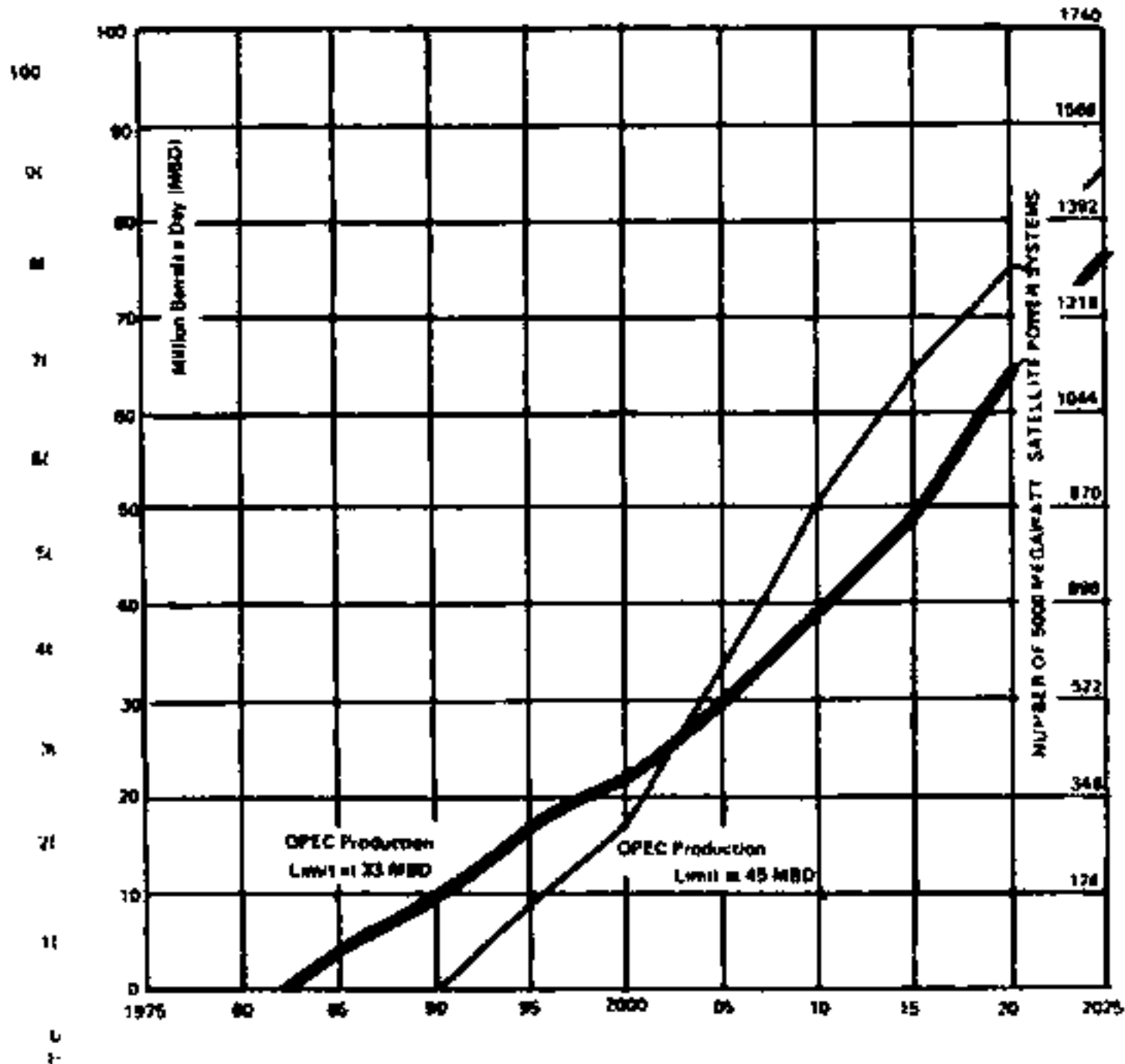
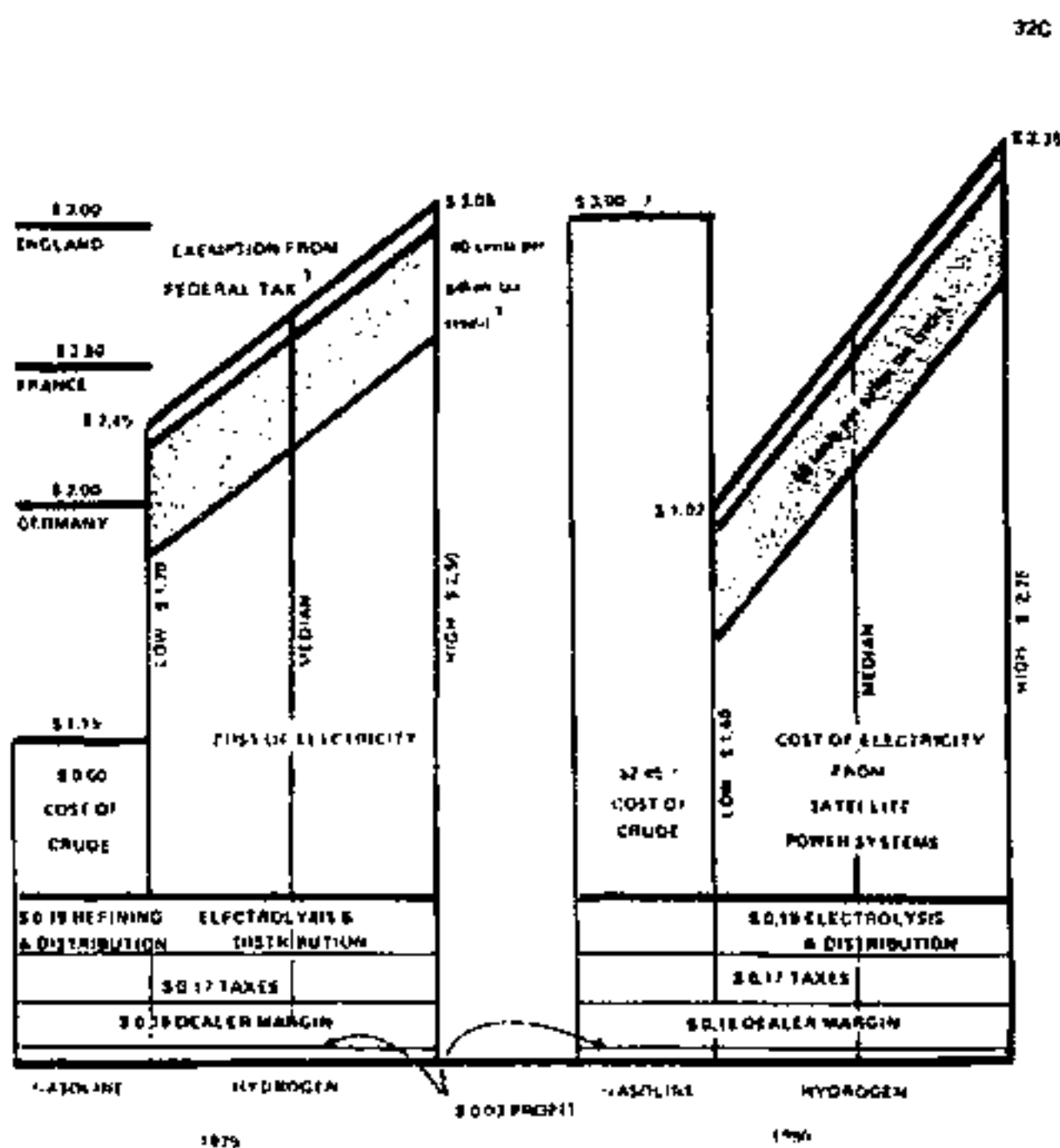

FIGURE PETROLEUM SHORTFALL LOW ECONOMIC GROWTH 3.4%

The equivalent energy content of 10 million barrels of oil can be produced by 174 SPS whose electricity is used at 90% efficiency to produce hydrogen

COST OF FUEL FOR TRANSPORTATION PRESENT AND FUTURE

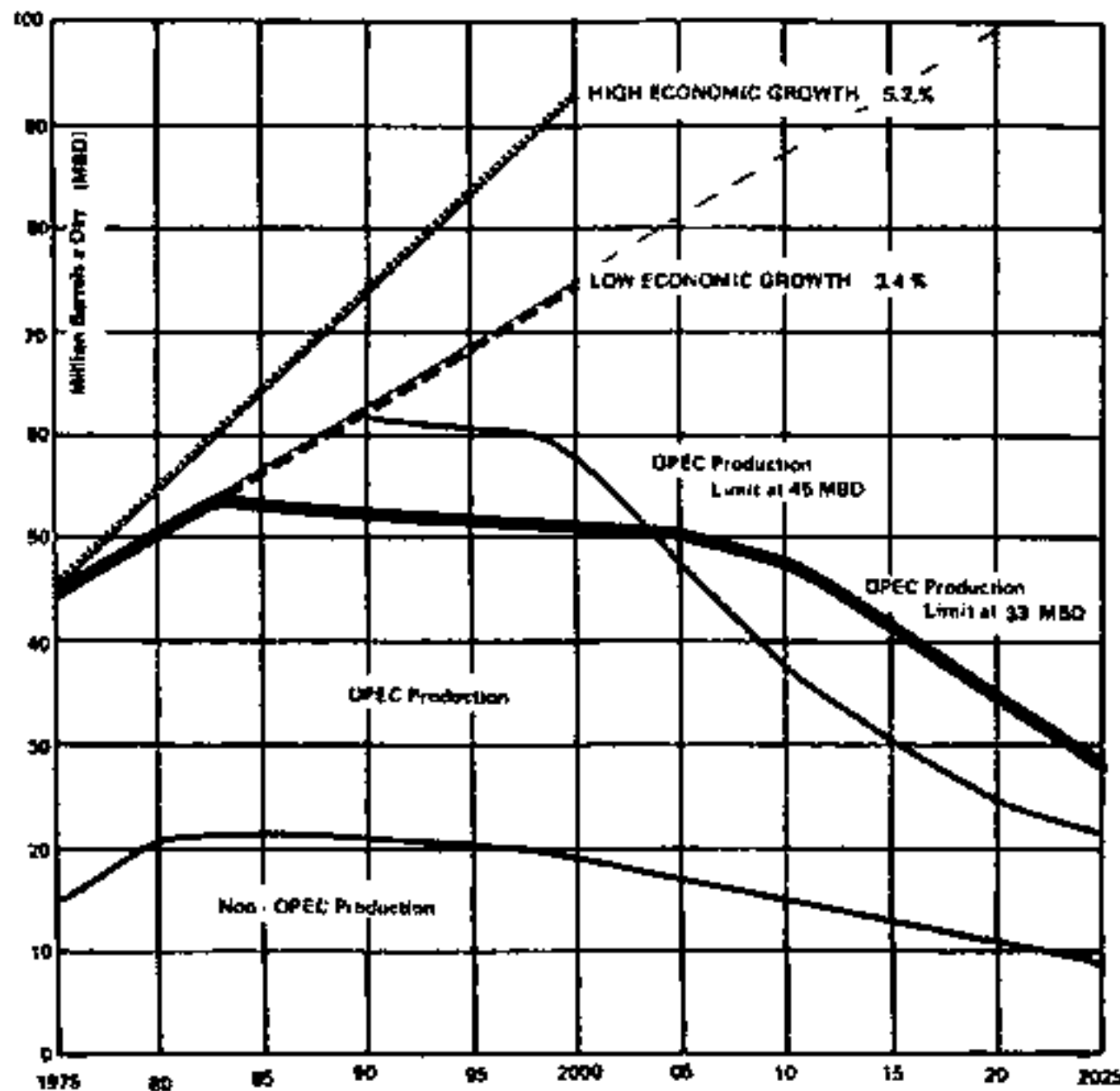

FIGURE SUPPLY VERSUS DEMAND

Supply based on gross additions to oil reserves of 10 billion barrels per year i.e. 1 North Slope discovery per year

TIME	SHORTFALL, MBD	Required number of Satellites in service	Number of Satellites added last 5 years	yearly average production
1990				
1995	8	139	139	28
2000	17	296	159	37
2005	35	619	323	63
2010	50	870	261	52
2015	65	1131	261	52
2020	75	1305	174	35
2025	85	1479	174	35

TABLE NUMBER OF SATELLITE POWER SYSTEMS NEEDED TO OFFSET PETROLEUM SHORTFALL based on low economic growth and an OPEC production limit of 45 MBD

YEAR	TOTAL SPSs IN SERVICE	REQUIRED PRODUCTION RATE
1989	--	1
1990	1	5
1991	4	10
1992	16	32
1993	48	60
1994	88	91
1995	139	122

TABLE REQUIRED FIRST 5 YEAR PRODUCTION SCHEDULE

ECONOMIC AND ENVIRONMENTAL IMPACTS OF SOLAR SATELLITE POWER SYSTEMS (SSPS)

Edward Passerini

The University of Alabama - University, Alabama 35486

The basic plan is to build perhaps 60, 5000 megawatt plants in space which would provide perhaps 20% of our domestic electricity in the year 2030 at a cost of perhaps one trillion dollars (neglecting inflation, cost overruns, unanticipated difficulties, etc.). The cost of the first 5000 megawatt plant would be about \$100 billion dollars (about 15 times the cost of a comparable terrestrial nuclear power plant). All of this assumes that the cost of photovoltaic cells will drop to about 25¢/watt (at which point the cost of cells to provide electricity on the roof of an average house would be less than \$2000). The plan appears to be outrageously expensive. Each plant would require the firing of some 11,000 Heavy Lift Launch Vehicles. The HLLV (not yet developed) would be much larger than the Saturn rocket and would have to carry about 500 tons apiece as opposed to the 30 (present) to 60 (projected) ton capacity of the Saturn/space shuttle system.

There are many environmental problems. The HLLV would punch unprecedented "holes" in the ionosphere. The microwaves would totally dry out the area under the rectenna. Birds flying through the microwave beam would become "uncomfortably warm" at best. For a bird crossing the center of the beam, "it is doubtful that an animal could survive such a flight." Two centimeter penetration and resonance would probably eliminate birds as well as butterflies. The beam might wander by accident and radiate human population or could be deliberately trained on human populations as a military weapon. The space platform is vulnerable to attack. The cells may have a very short life in space due to micrometeorite and plasma bombardment (perhaps more than 10% loss of capacity in only 10 years). The centralized power plant of rectennas would require a massive new land-lines system and would continue the present oligarchic system of power distribution. The beam would disrupt police, taxi, CB, and defence electronic communication equipment within a distance of perhaps 100 miles of the rectenna. The SSPS system adds heat (which would normally not reach the Earth) to the Earth's heat budget. The materials requirements are staggering. Each rectenna requires the output of a large copper mine, not to mention the steel and aluminum necessary. The array requires on the order of 3 million kg of synthetic sapphire, 3 million kg of Kapton, 3 million kg of graphite, etc.

Each of hundreds of technical problems could shut down the project; among the unsolved problems are: outgassing of graphite, static cloud effect around the array, grating lobe effects, loss of surface in vacuo, and repairs of random failure in an array of 10^5 klystrons.

The international implications are probably insurmountable. It is very doubtful that the international community will allow the U.S., which already consumes over 30% of the world's electricity, to fill up a large portion of the geosynchronous orbit over South America and the Eastern Pacific for such a project.

Some assumptions made in the "Reference System" are patently ridiculous; for example: the assumption of "zero launch-failure rate," the assumption of "no disposition costs," the assumption of 61% busbar efficiency, and the assumption of \$1.94/ft² for rectenna costs are all reminiscent of the early errors made by the nuclear industry.

One of the most disturbing aspects of the project so far is the duplicity of the approach. For example, Stephen Gorove's paper on "International Agreements" pretends to try to accommodate the spirit of the 1967 treaty while actually aiming to subvert the intent of the treaty. Claude Bain's paper on "Military Implications" carefully avoids addressing the real military issues and minimizes the impact of the issues it does address. So far, much of the effort seems to avoid coming to grips with the real problems or to even truly consider the possibility that SPS might be a technically, environmentally, socially or morally unsound project.

Much of the analysis to date has been disingenuous at best. Whyson and Donelek's conclusion that California might like the first SPS installation because of their "interest in environmental matters" is comic. Does Elder really expect other "energy-hungry" nations to join us? Vajk's list of "social criteria" is woefully inadequate.

Some aspects of the project (Van Allen precipitation, ionospheric heating) could prove disastrous and yet the conclusion is often reached that "there is no way to predict the impact of the full-scale project."

The question arises: Who is promoting the SSPS and why? Most of the promotion has come from NASA, large aerospace corporations (Boeing, Rockwell), and major nuclear/boiler suppliers (Westinghouse, General Electric). All of these are industries whose support base is eroding. NASA cannot justify continued manned exploration of near-space unless there are much more massive direct human benefits than resulted from Apollo/Skylab kinds of programs. The large American aerospace corporations are finding their sales slipping as European manufacturers are beginning to build more efficient aerospace vehicles. Orders for nuclear plants and other conventional plants are being cancelled as conservation and economics are beginning to take effect. All of this means that these industries and the congressmen who represent them (such as Ronnie Flipppo, D-AL) are the major influences in the SSPS movement. Most energy-related consumer organizations who support solar programs have taken strong stands against SSPS. Such organizations include Solar Lobby, Environmental Action, Center for Renewable Resources, and the Citizens Energy Project. The Sierra Club, Audubon Society, and other environmental groups have published critiques of what has been called "Pork Barrel in the Sky: a Solar Boondoggle to rival Nuclear and Synfuels."

SOURCES AND NATURE OF RESISTANCE TO SATELLITE POWER SYSTEM (SPS) DEVELOPMENT

William E. MacDaniel

Ass't. Prof. of Sociology, Niagara University, New York 14109

Although the Satellite Power System (SPS) holds the potential for providing alternative solutions to some of the most serious problems confronting terrestrial man, the decision to implement such a system will engender considerable opposition on the part of individuals and groups from all societal levels. Two general types of resistance must be considered: direct opposition and indirect opposition. Direct opposition will arise from organized groups whose interests are in conflict with, or are not furthered by, the SPS program, and from ad hoc groups that are formed in response to some aspect of SPS that is believed to be threatening. Indirect opposition is that which results from lack of support for SPS on the part of people who are indifferent, who lack knowledge, or who simply fail to take a position; i.e., the uncommitted group. This uncommitted group is likely to constitute a significant part of the general public. Direct opposition by organized groups will usually be motivated by a rational concern for achieving specific goals, while ad hoc group direct resistance is more likely to stem from emotional bases; both groups, however, are likely to appeal for support from within the uncommitted group and such appeals are likely to be emotional in nature, appealing to fears rather than to rational concerns.

Direct opposition from organized groups is likely to be most significant during the early stages of SPS planning and is likely to be aimed at preventing approval of SPS, or allocation of funding, by the U.S. Congress. Indirect opposition and direct opposition by ad hoc groups is likely to be more significant after approval and during those phases of the program that provide clearly identifiable targets toward which opposition can be directed; it is this type of opposition with which this paper is primarily concerned.

Individualism and self-preservation are among the strongest values held by our people. Altruistic self-sacrifice, a value that is competitive with individualism and self-preservation, also holds a high position in our value hierarchy but the motivation power of this value is inversely related to the social distance between the individual making the sacrifice and those who benefit therefrom; it is probably for this reason that we are not noted for our collective thinking and are more likely to act in ways that are advantageous at personal levels, or at levels which are delineated by community concerns, than to be motivated by national or worldwide concerns. "How will I benefit from SPS?" "Why should I suffer some disadvantage from which others will benefit?" These questions are more salient to our people than are questions concerning benefits to the nation or the world as a whole. Such personal concerns are likely to give rise to a variety of ad hoc forms of direct opposition and are likely to constitute the key to activation of significant numbers of the uncommitted group. Implementation of SPS is undoubtedly going to require some degree of self-sacrifice on the part of a

substantial number of citizens; our problem is to devise a way of implementing SPS which minimizes the requirement for self-sacrifice while overcoming the strong negative motivation associated with altruism as a benefit to some socially distant, poorly defined, collectivity of which the individual is only a small part.

Land Acquisition for rectenna sites is likely to provide the occasion for this ad hoc form of resistance, and it is likely to become manifest in the form of legal moves to block acquisition, picketing, demonstrations, petition circulation, appeals to legislators at all governmental levels, efforts to disrupt work in progress, and interposition of zoning and land use ordinances. Implementation of large federal programs has, in the past, always seemed to be caught by surprise by such activities; witness the Supersonic Transport, the problems with nuclear power plants, and the snail darter difficulties. Proper pre-planning should enable SPS implementation to proceed with minimal disruption.

The nature of the fears that SPS are likely to engender should be carefully investigated and identified. Initial efforts related to the search for rectenna sites should be carried out publicly and should be coordinated with a publicity and information program that is designed to allay the fears of people in the areas being studied. A significant part of this program should be the offer of an incentive which will have widespread appeal at the personal level; such an incentive might consist of a guaranteed low electrical utility rate for a specified period of time to all residents within a specified radius of the rectenna sites. Simultaneously, a lobbying program should be developed which is aimed at achieving support of local governmental officials. Local governmental officials and civic groups must be encouraged and permitted to participate in the planning and decision making, and all potential dangers of the SPS must be dealt with honestly, publicly, and in a forthright manner. Public support for the rectenna siting in the local area should be actively sought. The implementation plan must include an ongoing evaluation program which will facilitate early warning of local problems which are developing and means for dealing with such problems before they reach large proportions. Finally, after all potential sites have been identified, approval for selection of specific sites should be made on the basis of local referendums which reflect the will of the surrounding community.

SUN BUST, OR WHY SPS WILL NEVER GET OFF THE GROUND
David Steven Pate
Solar Energy Coalition - Alabama

Space Platform Solar advocates have lost any sense of social responsibility. Possibly this loss occurred during their educational training, a form of trained incapacity (paralysis by analysis). Or perhaps due to greed and the systematic rejection of any type of metaphysical, theological, or philosophical training. The form of technical determinism exhibited by these proponents at the expense of fellow human beings is to be abhorred by all. After finally achieving recognition and a certain degree of respectability, the solar advocates are faced with an even more perplexing problem. How to explain to the general public, how some solar technologies are to be desired, and some to be ignored. The technological trance exhibited by the SPS community reflects memories of the "bullish" years of the 50's and 60's (which in many cases has evolved into the nightmares of the 70's).

Technical feasibility of the SPS proposal is uncontested. Science is no barrier to weird and seemingly wonderful ideas. However, the technical feasibility of SPS does not increase one iota, the desirability on a social, economic, or energy basis. Careful examination of projected population and energy needs for the time frame involved with SPS development eliminates any argument for continued R&D. To this end, there are sentiments in Congress to eradicate any SPS funding. NASA officials, in Congressional hearings, have testified that they do not think additional funding is needed, but they have not called for an end to SPS funding either. With this in mind, consider who will use the tremendous amounts of electricity which 60 SPS units would generate. On the other hand, then consider with projections of U. S. energy consumption for 2000 varying from 33-124 quadrillion BTU's, the impact that the decentralized, terrestrial solar technologies can provide.

Who then stands to profit from SPS R&D and Evaluation (not to mention implementation)? Surely, the private vested interest and not the American public. We have the know-how, but do we have the know-why? The SPS advocacy demonstrates that they do not. What we need is not technology, but appropriate technology - and lots of it. Earth based technologies developed or being developed (in every community in the world) are the long-term answers to our energy needs. The SPS concept fails at being a long-term solution due to micrometeorite bombardment and the resource and capital intensity it entails. SPS is an exotic (which is exactly what the large energy corporations have told us all along) solar technology, which defies the competitive nature of solar energy utilization that the American public hopes for. SPS promotion by the industrial/aerospace groups is an active attempt to keep energy supply controlled by the vested interest and for the vested interest. This concept is a far cry from the ideological base which has brought solar energy into credibility and acceptance by the general public.

The justifiable criticism of the D.o.E. (Department of Entropy)/NASA "megalevel" approach to solar energy development is credenced by the disparity between "hard" technology and "soft" technology funding. The fact of the matter, is that for every dollar and resource going into SPS development or evaluation, there is one less dollar available for the more sane, terrestrial applications. Another thorn in the side of solar advocates is that controversy over such capital/material intensive solar technologies keeps the man in the street from accepting

that solar energy is here and now for practical, economical utilization. Once an individual pays for his/her solar system it belongs to them, their own "utility company." With SPS, the taxpayers will subsidize the utilities, etc. to have them enter the SPS market, only to turn around and have to purchase at very high rates, solar electricity. Why won't individuals simply purchase their own photovoltaic arrays and generate their own "roof-top" electricity? The answer is that they will indeed. Primarily because when cells are cheap enough for SPS applications, they will also be inexpensive enough for the general public.

NASA participation is due to a declining support base, which naturally would rejoice at another "moon race" scaled program. Of course, one would expect Congressional support for SPS funding to come from heavy aerospace constituencies such as Flippo (D.-AL), and Fuqua (D-FL). The formation of several appropriate technology oriented solar political action committees should decrease the possibility for this support base to be reelected in 1980. The energy crisis will be wrangled in the political arena as well as your neighbors backyard. Strong sentiments from the solar community have already limited current SPS funding exclusively to terrestrial feasibility studies. Still in our infancy, we are educating the American public faster than your institutions are learning. By the time the appropriate technology community reaches puberty, SPS will be remembered as a technology "that never got off the ground."

PRESS PERCEPTIONS OF S.P.S.
Dave Dooling
The Huntsville Times, Huntsville, Alabama

The news media will play a major role in public acceptance of SPS as a national project should it be adopted as a leading energy program. While the major national news outlets -- such as the Associated Press, United Press International, ABC, NBC, and CBS -- are equipped to understand and report SPS in a factual manner, the public view will be shaped by the editorial policies and understandings of local newspapers and radio and TV stations. Few of these will be staffed by even parttime science reporters, and portrayal of SPS may vary depending on locale of the outlet, political and social slants of management, and misconceptions that may have already been formed. Initially, it is assumed that most opinions will fall into those camps that either see SPS as the best solution to the energy crisis, and those who see it as an orbital version of the Teapot Dome, with a minority in the middle considering it to have promise requiring proof. Obviously, there is no way to directly convince the press that SPS is good or bad -- any such effort would immediately turn the press against such an agent. What will be needed are seminars to help the press to understand those areas of SPS that are understood, and to cope with the areas that are yet to be tested. Most important, they must be made aware that there are major differences between concepts under study and projects being built. This paper will examine SPS as viewed by the press during the 1970-79 period. Research will be conducted with NASA historical files and by telephone interview. No major poll will be conducted.

The author is science editor for The Huntsville (AL) Times.

[Extended Abstract Not Received]

THE INDUSTRIAL INFRASTRUCTURE FOR THE SOLAR POWER SATELLITE

Dr. Peter E. Glaser - Dr. Philip K. Chapman
Arthur D. Little, Inc. - Cambridge, Massachusetts

Implementation of the solar power satellite (SPS) scenario based on the addition of 10 GW per year to installed generating capacity could have significant industrial impacts as the additions would be comparable to the production requirements of the utility industry which invests about \$25 billion a year. The materials and resources to support a 10 GW per year SPS construction scenario have already been studied as part of the DOE/NASA SPS Concept Evaluation Program.¹ Therefore, it is important to determine whether the buildup of the required industrial infrastructure would significantly strain industrial capabilities assuming that an SPS design would be evolved which could meet materials and resource supply criteria.

An assessment of the impact on the industrial infrastructure of key subsystems of the SPS reference system was performed² by comparing the SPS production requirements with the present and projected capabilities of U. S. industry in applicable industry sectors. Analysis of the timing of production plant capacity additions and associate capital investment indicated that there is considerable latitude either to delay a plant start-up date to complete development of promising technologies, or to start the production earlier to reduce the impact on an industry sector without a serious cost penalty. The results of the assessment of the impacts on the industrial infrastructure for specific subsystems are as follows:

1. Photovoltaic Subsystem

Figure 1 compares the SPS photovoltaic subsystem production requirements with terrestrial growth in the production of solar cells for two scenarios. Terrestrial photovoltaic production capacity was assumed to displace one quad of primary energy in 2000 (the upper bound for the photovoltaic contribution projected in the Solar Energy Domestic Policy Review) which is comparable to the 10 GW per year SPS buildup. The production of the photovoltaic subsystem for a 2.5 GW SPS pilot plant, which would allow the development of production equipment and experience, could be spread over five years. Allowing for inefficiencies in the SPS microwave power transmission subsystem, an annual photovoltaic subsystem production capacity of 600 MW would be required. Additional photovoltaic inventory of 5 GW would be provided by 1994 to meet requirements of the first 5 GW operational SPS prototype in 1994, and to achieve full-scale production in 1995 to support SPS buildup at 10 GW per year. The energy input to the

production plant would be 6.7×10^{10} kWh (provided by two 5 GW SPS in nine months). The capital cost of the industrial plants would be about \$2.7 billion and require integrated but not necessarily colocated plants with an area of 260,000 m² which is comparable to the Boeing 747 aircraft plant.

The magnitude of the photovoltaic subsystem production requirements would result in the creation of a significant new industrial capability which would affect several industrial sectors.³ Expansion of production capacity to meet both SPS and the terrestrial photovoltaic markets would reduce the potential business risk to industry participants implied by a buildup of industrial capacity for a single large program.

2. Ion Engines

The production requirements for ion engines are about 40,000 per year, primarily for replacement or refurbishment in the SPS. The characteristics of the production plant will depend critically on the design lifetime of the engine and the use of either readily available or exotic materials, degree of quality control, labor skills, and required tolerances. The production steps for ion engines are comparable to those now in use in the aerospace and electronic industries. The ion engine production rate will be modest compared to analogous production requirements of, for example, color television.

3. Dipole Rectifiers

To support the SPS buildup at a rate of 10 GW per year, a continuous production process capable of delivering completed dipole rectifier elements at the rate of 625 per second would be needed to produce 2×10^{10} dipoles per year. This process will consume about 42,000 mt of aluminum for the dipole strip, and 14 mt for gallium arsenide Schottky diodes per year. Divided between several hundred automated machines, these production rates would not be of sufficient magnitude to stress the capabilities of electronics and related industries. Receiving antenna design changes could reduce diode production requirements and avoid handling of very large numbers of discrete components.

4. Microwave Generators

Figure 2 shows the gross annual power output of microwave generators as part of U. S. microwave oven sales. The annual production requirements for a 2.5 GW SPS pilot plant of about 600 MW per year would be well within current production capabilities of the microwave industry of close to 2 GW per year, if the microwave generator would be a magnetron rather than a klystron, which has only a limited market. The existing microwave industry capacity appears adequate to meet SPS microwave generator production requirements.

5. Graphite Fiber Reinforced Composite Structures

About 4000 mt of graphite fiber composite structures may be required for a 5 GW SPS. As Figure 3 shows, projections of the U.S. market for graphite fibers indicate that this production level will be reached by about 1990. Furthermore, extensive use of graphite composite structures in automobiles could result in

markets of 10,000 mt by 2000 which may grow by several factors beyond this period dwarfing SPS production requirements. If polyacrylonitrile (PAN) fiber would be used as the starting material for graphite fiber production, then industrial capacity would be adequate as it would also serve other major markets. If high modulus graphite fibers would be required for the composite structure, a substantial increase in industrial capacity would be required because of the very limited production of rayon fiber used as the starting material.

CONCLUSION

Production requirements for the SPS photovoltaic system will have the greatest industrial impacts and result in the creation of a new industry sector which could also serve the terrestrial photovoltaic market. The production requirement for ion engines and dipole rectifiers, although different than those of existing industries, are comparable to a single major production facility in the consumer electronics or automobile industries. Microwave generators and graphite composite material requirements could be integrated with a growing industrial production capacity already serving other markets if PAN fibers could be used. The impacts on U. S. industry of the SPS implementation scenario could be further reduced if cooperative arrangements are made with other countries who may be participants in an international SPS project to produce either subsystems or supply components or materials required for SPS production.

COMPARISON OF SPS PHOTOVOLTAIC PRODUCTION REQUIREMENTS WITH TERRESTRIAL MARKET GROWTH SCENARIOS

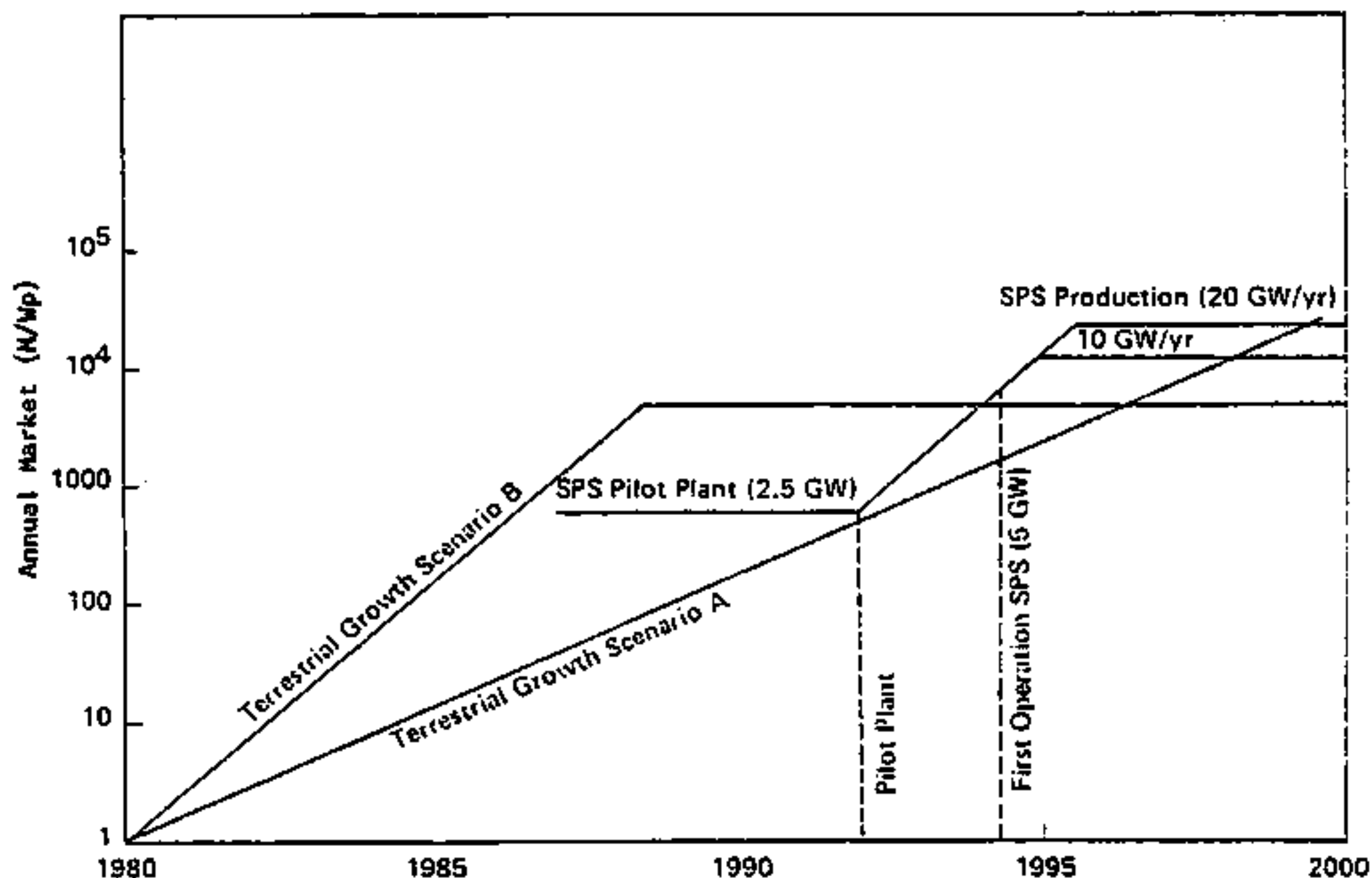

Source: Reference 2.

Figure 1.

Note: Terrestrial Growth Curves are scaled to displace 1 Quad of primary energy in 2000.

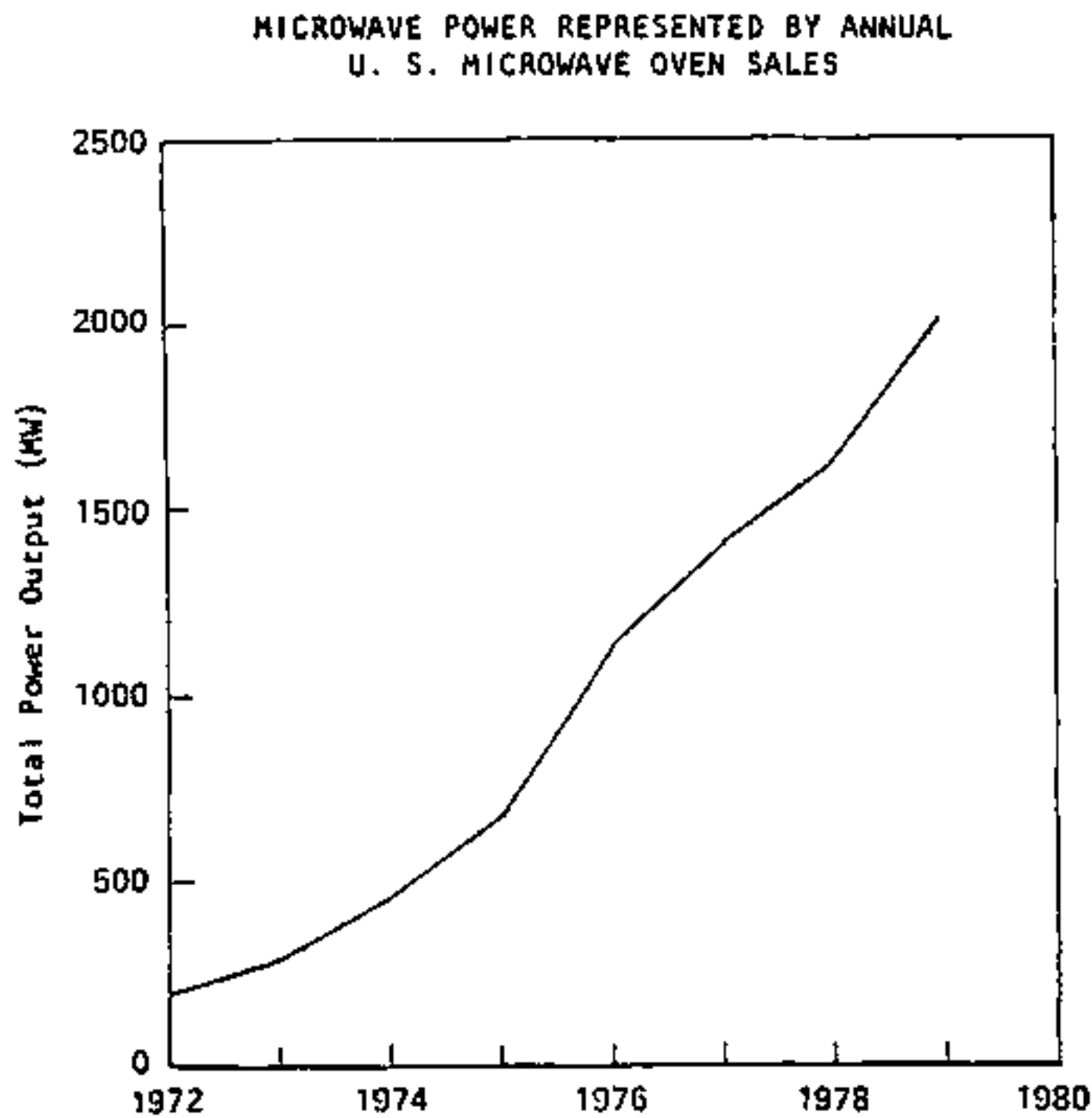

Source: Reference 2.

Figure 2.

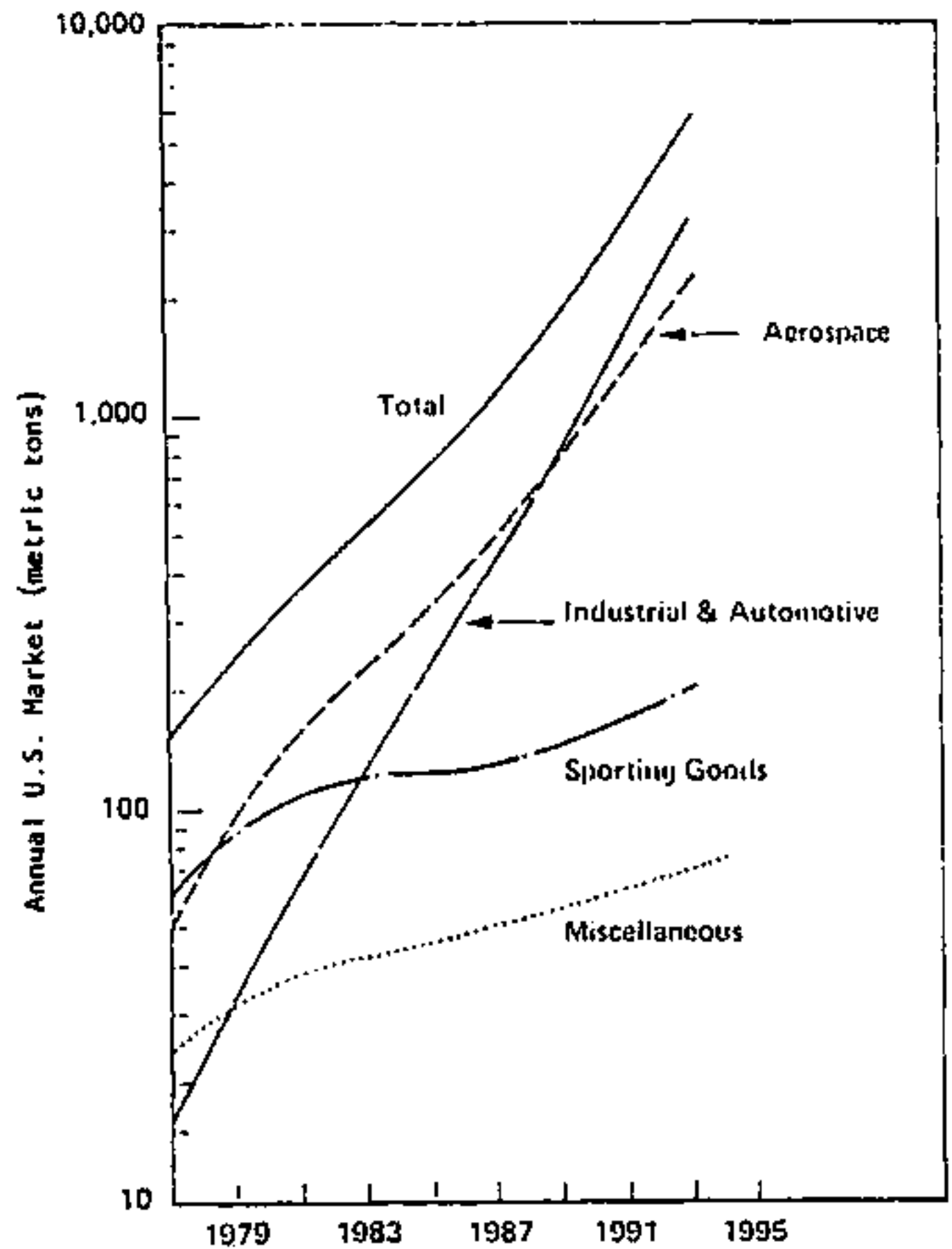

Source: Reference 2.

Figure 3.

Note: These projections do not include extensive automotive uses.

¹A. D. Kotin, "Satellite Power System (SPS) Resource Requirements (Critical Materials, Energy and Land)." HCP/R-4024-02, U. S. Department of Energy, Washington, D. C., October 1978.

²Arthur D. Little, Inc., "The Industrial Impact of the SPS," Final Report, Phase II, Boeing Aerospace Co., "Solar Power Satellite System Definition Study, NAS9-15636, November 1979.

³Arthur D. Little, Inc., "Evaluation of Solar Cells and Arrays for Potential Solar Power Satellite Applications," Final Report to NASA, Lyndon B. Johnson Space Center, NAS9-15294, March 1978.

UTILITY SYSTEM IMPACTS OF THE SATELLITE POWER SYSTEM

Frank R. Goodman, Jr.

Electric Power Research Inst., P.O. Box 10412, Palo Alto, CA 94303

The technical requirements and barriers for integration of the satellite power system (SPS) into an electric utility network are discussed. For the purpose of discussion the overall SPS concept is considered to be composed of up to sixty individual 5 GW SPS units. This concept has been selected to reflect the preferred SPS design currently under examination through programs funded primarily by the federal government. This paper focuses on problems that would arise in attempting to interconnect a single 5GW SPS unit with an electric utility system. The potential difficulties with handling large blocks of power produced by an SPS unit are examined in the context of utility planning and operating practices. The features of the earthbound receiving antenna (rectenna) are especially important in examining the utility interconnection problems, but the operational limitations of the space-borne portion of the SPS unit are also a determining factor. The emphasis herein is on technical problems rather than economic problems. The economic ramifications of these problems are addressed only in a relative sense, because uncertainties in the cost of the SPS concept do not permit a reliable estimation of cost figures.

The time frame for the SPS scenario discussed in this paper is the first half of the next century. The technical issues identified and examined are generic, rather than specific to a particular utility scenario. However, the size of the utility system or power pool with which an SPS unit is interconnected is an important variable that is taken into account. In this manner the technical treatment should remain valid in spite of uncertainties associated with the technology and characteristics of future utility systems. The foremost technical problem area to be considered herein is utility system operation with an SPS unit interconnected. Before examining specific operating problems, a judgment must be made as to whether or not an SPS unit can be operated as baseload, intermediate, or some other mode of generation. The actual reliability of an SPS unit is clearly unknown at this point in time, but let us assume for the moment that its reliability is very high. In this case the SPS unit might be used as baseload generation together with coal and nuclear power plants which are likely to be the primary forms of baseload generation in the time period of interest.

The use of an SPS unit as baseload generation suffers from one major drawback involving the outage during eclipse periods whose time duration and time of occurrence during the year are exactly predictable. During these periods, a major block of baseload generation (5 GW) is unavailable and must be replaced by reserve units. The exact dispatch strategy will depend on the characteristics and size of the utility or power pool in question. Some possibilities are to use spinning reserve, commit intermediate units, start peaking units, or purchase power through an interarea exchange agreement. In any case a significant component of cost is introduced that does not exist in all conventional baseload generation mix due to increased cycling duty of the backup units and due to the fact that the backup units may be less efficient than baseload units. The argument might be made that this problem is mitigated somewhat by the fact that the eclipse periods occur around local midnight when utility daily demand profiles have historically been near their low point for the day. This argument loses its validity if one envisions a future scenario in which widespread usage of load management programs has flattened out daily demand profiles compared to their historical form. Finally, this problem is compounded in the situation

where multiple SPS units are serving a nationwide system of interconnected utilities, because the ability to draw backup power through interarea exchange is diminished as the outage of SPS units propagates across the nation.

Another major operating concern is maintaining system stability. System stability is a design as well as an operating problem which is a function of the system characteristics, including both generation and electrical network. System disturbances caused by failure of large components are generally more severe than those associated with small components. Thus failure of an SPS unit or a large transmission line segment associated with an SPS unit presents a substantial stability problem. Consequently, in planning for installation of SPS units, detailed stability studies would have to be performed in order to determine if a suitable system design can be arranged. These studies would have to consider dynamic impacts of an SPS unit under various conditions of system load and scheduled outages. Furthermore, the addition of SPS units to a national power network in lieu of large conventional synchronous machines will result in less system inertia associated with the rotating mass of conventional machines and further complicate the stability problem.

Additional operating problems include load following, output level control, reliability, and maintenance scheduling. The value of an SPS unit will be highly dependent on whether or not its output level can be stepped up or down to accommodate changes in power system demand. Additionally, it is highly desirable that an SPS unit be able to rapidly respond to momentary power fluctuations. It is probable that an SPS unit may be a cause rather than a cure for power fluctuations. Because of its size, complexity, and enormous number of components, an SPS unit may be subject to small output fluctuations which as a percentage of the 5 GW rating are not minor from a utility system operational standpoint. Reliability and maintenance requirements are subject to considerable uncertainty; but due to the large number of components involved, the maintenance requirements would be substantial even at a low failure rate.

INSTITUTIONAL CONSIDERATIONS OF SPS/UTILITY INTEGRATION
Dr. Meredith S. Crist, Consultant
1115 Pine Street
Santa Monica, California 90405

This study investigates institutional development of the U.S. utility industry and how various scenarios of industry evolution would affect utility involvement in the SPS program. The implications of past and ongoing structural changes in oil prices and energy economics, alternate energy technology developments, national energy policy, state regulatory climates, and financial pressures are analyzed for their impacts on utility perceptions of SPS viability.

This research on institutional issues in SPS/utility integration was conducted in the following sequence:

- 1) Likely organization/management/financing forms for the SPS program were reviewed. Due to the SPS financing needs for design, development, testing and engineering before revenues commence, the study concludes that the commercialization organization can and should be separate from the (government funded) DDT&E.

This study in its entirety identifies imposing institutional problems preventing utilities from contracting for ownership and operation of either or both SPS ground stations and satellites until several years of successful demonstration. Therefore, the report's initial discussion on SPS organizational forms selects an international, non U.S. utility consortia commercialization similar to the COMSAT/INTELSAT structure.

- 2) The DDT&E financing dictates an all-or-nothing commitment to a program of 60 SPS units. The question of whether the U.S. can absorb 300 GW of new baseload was evaluated by reviewing existing (1978) forecasts of energy supply and demand, projected electric capacity from conventional sources, and the potential role of up to 25 percent from solar technologies. The study concludes that 300 GW can be absorbed, assuming reasonable SPS costs and schedules. (This study does not analyze comparative costs of SPS relative to conventional or alternate energy sources.)
- 3) Implications of the heterogeneous mix of utilities (cooperatives, municipals, investor-owned, federal systems) were examined to determine institutional barriers to forming systems large enough to absorb single SPS 5 GW power sources. Negative factors identified are regulatory rate and siting disparities across state jurisdictions receiving SPS power. Positive factors are proliferation of joint ventures and of power pools and federal promotion of increased

interconnections, wheeling, pricing of transactions sales, and reliability assessment. Concluding, the net effect of regulatory siting procedures imposes tremendous obstacles to SPS.

- 4) Utility financial pressures were examined together with rate regulation of bulk power versus self-generation to evaluate utility's financial disincentives to SPS participation. Conclusions are that the evolution of the private utility industry will be largely driven by financial determinants which make large and risky capacity expansions unattractive.
- 5) Utility planning and operating procedures are reviewed to simulate how the SPS would be incorporated in utility long run planning, reliability and investment analysis. Conclusions are that very few potential technical/operational disincentives were identified for the integration of 5 GW increments of SPS power.
- 6) Building on the above review of institutional issues and ongoing structural changes, scenarios of likely industry evolution are developed, each with implications for utility involvement in SPS. Those scenarios include:
 - o Increased utility reliance on conservation, load management, and use of alternate energy sources.
 - o Business-as-usual with utilities' continued pursuit of large nuclear and coal power plants.
 - o Three mini-scenarios of utility involvement in SPS ranging from bulk power purchase, to rectenna ownership, to rectenna and satellite ownership.

Conclusions are that institutional barriers will prevent U.S. utilities from ownership of the ground stations until the first SPS is successfully demonstrated, probably in the Tennessee Valley Authority which is the logical system in which to locate the first SPS. Ownership of ground stations and satellites by U.S. utilities would be unlikely until after some 10 such units, although the institutional barriers for U.S. utilities do not restrict state-owned utilities in other industrialized nations.

AN ASSESSMENT OF SPS UTILITY INTEGRATION ISSUES ARISING FROM THE
DISTRIBUTION OF ELIGIBLE RECTENNA SITES AND ELECTRICITY DEMAND CENTERS

John A. Hill and James A. Rabe

Environmental Resources Group - 6380 Wilshire Boulevard

This study identifies institutional, regulatory and technical utility integration issues involving the distribution of eligible rectenna sites and electricity demand centers throughout the continental United States. The report assesses both the integration issues/problems associated with siting a network of 60 SPS rectennas in the continental U.S., and the extent to which these problems are mitigated and/or exacerbated by the nominal SPS rectenna distribution pattern developed in the course of this study.

The research was conducted in the following manner: (1) a disaggregated projection of energy demand for each Electric Reliability Council (ERC) region was developed over the SPS timeframe, based on Energy Information Administration (EIA) projections; information concerning the types of units (e.g. coal, nuclear, renewable, etc.) used to provide electric power generation were included. These data were then used to assess the projected baseload electricity generating capacity (Exhibit 1) for each of the 171 Bureau of Economic Analysis (BEA) Areas in the continental U. S. (2) Maps indicating 13 km x 13 km cells of the U. S. which were eligible for service as rectenna sites were compiled. (These maps and the information used to prepare them were developed as a part of other ongoing SPS research). (3) A set of rules/constraints for rectenna siting was developed using the EIA electricity generation projections and also considering institutional and technical SPS integration issues. (4) These rules were used in conjunction with the map of eligible areas to develop a number of nominal rectenna distribution patterns indicating both the location of rectennas and the load centers which they would serve. (5) These nominal rectenna distributions were then analyzed to determine whether the resulting patterns created any integration issues beyond those identified for a single rectenna, and to assess the extent to which the rectenna distribution patterns exacerbated and/or mitigated previously known integration issues/problems. Many of the integration issues were also assessed to determine whether significant regional variations existed.

Several significant results and observations follow from the study. First, in many instances both the siting constraints and the rectenna distribution pattern which resulted from the application of these constraints served to mitigate integration concerns. For example, one of the siting constraints limited SPS penetration to 25 percent of projected baseload power for each BEA load center. This constraint limits the problems associated with maintaining adequate spinning/operating reserves and electric system reliability; and it was found that this 25 percent limit resulted in a dispersed power plant distribution pattern which reduces (by dilution) the impacts of integrating SPS into the utility grid serving any given region. Second, in most instances (with the notable exception of the West) it was possible to site rectennas within 150 km of the load centers they would serve, indicating that SPS power in general would not require excessive transmission distances. Third, with very few exceptions it was possible to site rectennas within the ERC regions which they served, providing relief from many institutional and regulatory issues. Siting rectennas within the consuming regions would reduce the need for additional interregional interconnections, and also would mean that the societal costs and benefits associated with each rectenna would occur within the same region.

Perhaps the most important conclusion which can be drawn from this effort is that it appears possible, in terms of availability of eligible rectenna sites and load center distribution throughout the U. S., to site 60 SPS rectennas in a manner generally consistent with existing utility planning practices.

EXHIBIT 1 POTENTIAL FOR ACCEPTANCE OF SPS
CAPACITY BY BEA LOAD CENTERS¹

<u>BEA No.</u>	<u>Name</u>	<u>1990 Electricity Consumption (Quads)²</u>	<u>2020 Acceptable SPS Capacity (Gigawatts)</u>
1	Bangor, ME	.0180	0.6
2	Portland, ME	.0286	0.9
3	Burlington, VT	.0196	0.6
4	Boston, MA	.1569	4.8
5	Hartford, CT	.0934	2.9
6	Albany, NY	.0439	0.9
7	Syracuse, NY	.0485	1.0
8	Rochester, NY	.0422	0.9
9	Buffalo, NY	.0638	1.3
10	Erie, PA	.0227	0.5
11	Williamsport, PA	.0185	0.4
12	Binghamton, NY, PA	.0256	0.5
13	Wilkes-Barre, PA	.0276	0.6
14	New York, NY	.5409	11.3

1. A partial list, the complete list of 171 BEA areas is provided in the report.

2. "Quads" represent quadrillion BTUs.

Satellite Power System - Societal Assessment
Utility Integration Study

Environmental Resources Group
 April 1980

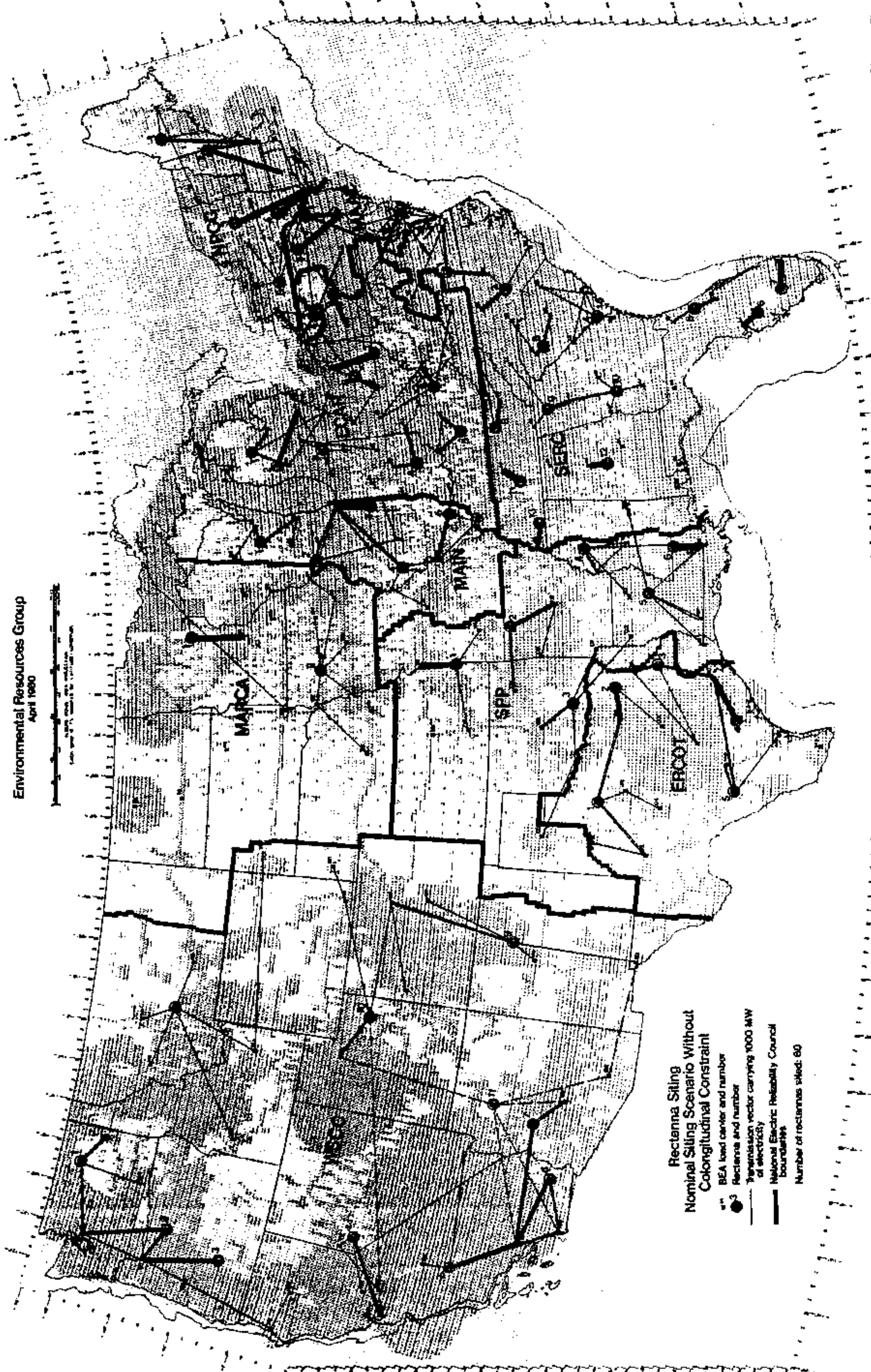

Rectanna Siting
 Nominal Siting Scenario Without
 Colongitudinal Constraint

- BIA load center and number
- Rectanna and number
- Transmission vector carrying 1000 MW of electricity
- National Electric Reliability Council boundaries
- Number of rectannas sited: 60

ELECTRIC UTILITY REQUIREMENTS AFFECTING SOLAR POWER SATELLITE DEVELOPMENT
AND DEPLOYMENT

K. R. Kubitz and R. H. Moss

Pacific Gas and Electric Company - San Francisco, California 94106

The electric utility industry consists of several thousand generation, transmission and distribution entities. It is vertically integrated from the stage of primary fuel consumption to retail delivery, and expanding at both ends, with important consequences for the development of the Solar Power Satellite (SPS). The favorable basic economics of the electric industry were reflected by the fact that the price for residential electricity had dropped from 1900 to 1940 and remained steady into the 1960's.

Traditional utility planning made estimates of demand based on stable historical trends, led planners to evaluate the reliability and economics of commercialized supply options, and select a resource plan whose costs were routinely passed on to financial planners for capital development from internal and external sources. Several major changes have occurred which must be reflected in planning for SPS development.

First, demand growth has become much more erratic. Second, utilities must evaluate a much broader portfolio of potential options, including geothermal, solar space and water heating, cogeneration, wind, biomass and conservation as economic means of meeting customers needs. Third, there is an increasing capital constraint on resource plans because of the unwillingness, in an era of rising rates, by regulatory agencies to provide returns that permit raising of new capital with the ease of the past. Fourth, a shadow pricing system representing the divergence between market prices for alternatives and the perceived social costs of public policymakers has emerged. A principal example is the incremental oil import cost estimated by the Harvard Business School study Energy Future at \$85/bbl. Fifth, there is increasing regionalization of energy decisions.

The SPS concept must be evaluated on the basis of utility criteria for future resources, including least cost (minimize revenue requirements from customers), financial risk (capital intensity and lumpiness), reliability (technology and operation), resource diversity, oil displacement, and technology development.

SPS system definition studies have indicated busbar costs of 5-6¢/kwhr at a production rate of 1 SPS/yr and 3-4¢ at 4 SPS/yr. One estimate has reached 2.6¢/kwhr in 1979 dollars based on an expected extended life for the geosynchronous environment. On the other hand, given the conservative assumption that mature SPS system costs are only \$1,000 per Kw more capital intensive than coal or nuclear systems, the SPS is a major financial risk. It would be necessary to reduce risk through pooling, turnkey contracts, or other measures.

For the three planning reliability criteria of: 1 day in 10 year Loss of Load Probability, 12% of monthly peak load, and two largest risks, a 5 Gigawatt (Gw) SPS in conjunction with another 1,000 Megawatt (Mw) unit could require 6,000 Mw of reserve capacity, which would predominate until monthly peak load reached 42 Gw. SPS would contribute to resource diversity and significant oil displacement.

California siting requirements discuss need for proposed facilities, likelihood of compliance with applicable laws and regulations, safety and reliability, and whether there are alternatives to the proposed project which are economically, environmentally, and socially preferable. Need has several components including

growth, retirements, replacement of purchased power, and oil displacement. Renewable resources are preferred. A demonstration SPS rectenna site, because of its renewable primary fuel and oil displacement potential, could conceivably receive favorable regulatory treatment such as inclusion of construction work in progress (CWIP), expedited regulatory proceedings and advance guarantees of prudence of expenditures.

Projected SPS costs, which must still be proven, are comparable to or favorable compared to a number of alternatives, including wind, biomass, hot water geothermal, or fuel cells. Estimates of costs of conserved energy for on-site solar thermal applications as derived by Lawrence Berkeley Laboratory are also comparable to SPS costs. Solar thermal costs for a \$2,200 system are 3.3-7.4¢/kwhr based on lives of 20-10 years (LBL-9959). If solar thermal systems are subject to short lifetimes and escalation in component costs, best estimate SPS busbar costs could be significantly lower than on-site solar use.

Utility involvement in SPS development would be undertaken in a multi-stage series of levels of support based on a benefit-risk analysis of the future undertaking. First, a utility might agree to buy power, generated by SPS, at a terrestrial point in its area for a price under the marginal cost of alternatives. Second, a utility might construct major transmission and substation facilities. Third, when reasonably sure that SPS will operationally transmit reliable power, utilities would construct rectennas.

The Federal government can encourage involvement by utilities by establishing a national policy to "go satellite solar," by providing financial assistance to utilities to reduce oil use, by early allocation of western Federal land for demonstration rectenna sites, by developing demonstration projects to sell power to utilities at less than marginal costs, to fully fund environmental studies to provide future public assurance of adequate identification and mitigation, and by financial incentives such as CWIP, higher investment tax credits, and higher rates of return for renewable resources such as Solar Power Satellites.

THE POWER SATELLITE: TOWARD WHICH ENERGY CRISIS?
T. A. Heppenheimer
Center for Space Science - Fountain Valley, California

What role may the power satellite play in meeting future energy needs? To gain insight into this question, one must consider carefully the changing prospects for energy in the decades to come. It has been proposed that the powersat be developed during the next twenty years, to aid in meeting near-term needs. This goal is neither feasible nor desirable. However, a somewhat longer development time may prove quite justifiable, in order to meet the "second energy crisis."

In considering our present energy problems, the term "energy crisis" is a misnomer. What we have is a petroleum crisis, and to a lesser degree, a fossil-fuel crisis. During the years 1950-1973, the U.S. and world economies came to rely on abundant supplies of petroleum at costs which were low, and diminishing in real terms. (Arabian oil was \$2.17 per barrel in 1947, \$1.79 in 1970.) Recent massive OPEC price hikes, and attendant supply instabilities, have not caused the crisis. The crisis has been caused by physical limits on the availability and recovery rate of the world's petroleum deposits. Indeed, as early as 1956 the geologist M. K. Hubbert predicted that U. S. production would peak in 1970, as it did. Today not even Saudi Arabia has major untapped production capacity.

Although \$2-per-barrel hydrocarbons may never again be seen, it is generally accepted that acceptable petroleum substitutes are available from the world's stores of non-petroleum fossil fuels. These include heavy oils, tar sands, oil shales and coal. In seeking to develop these alternative sources, the difficulty is the present-day lack of an industry akin to oil refining, which can accept the crude feedstocks as taken from the ground, and render them into a range of useful products. This difficulty may also be seen in that whereas crude petroleum is an excellent feedstock for existing refineries, coal, shale oil, and the like all require stages of industrial processing before they can be upgraded to useable synthetic crudes.

The solution to our present petroleum shortages then will lie in the development of these synfuel industries. Their growth rates will be limited chiefly by considerations of capital formation, environmental regulation, and (particularly in their startup phases) the overcoming of unanticipated difficulties, in order to guarantee economic attractiveness. This last point is important. Oil shale has been recognized as a potentially important resource for most of this century, but its costs have delayed its development. The basic Fischer-Tropsch process for making gasoline from coal was patented in Germany in 1925. Since 1955 South Africa, a nation with abundant coal but little oil, has made a very strong commitment to Fischer-Tropsch gasoline, but even after it completes two very large new plants in 1985, it still will obtain some 50% of its gasoline from petroleum.

If in this country we have built no Fischer-Tropsch plants, despite the decades-old and well-tested character of the process, then what may we say of the power satellite? Since the near-term problem is petroleum, the powersat must be assessed in its light. The powersat is a generator of electricity. In 1977, 17% of America's electricity was generated by burning oil. This amounted to 9% of overall petroleum product use, or 631 million barrels. This is projected to change to 878 million barrels per year in 1987, or 15% of generated electricity. Hence, even if powersats were instantly available to replace our oil-fired generating plants, their contribution could amount to the equivalent of no more than about 10% of our domestic oil usage, or 20% of our imports. Nor should we

anticipate a broad-scale electrification of autos, home heating, etc. The replacement value of existing vehicles and furnaces is of the order of $\$10^{12}$, and most of this is personal property which is not subject to amortization via tax writeoffs for depreciation.

So much for the present energy crisis. However, one finds a different picture a century or so ahead; this is the second energy crisis. Zimen and Altenhein have estimated the world's exploitable fossil-fuel reserves as equivalent to 7.1×10^{12} tons of carbon. If these reserves are exploited with 5% annual production increase (the value which held from 1960 to 1970), then by 2060 production will top out, and we will be in the same situation we face today with petroleum.

Even before we face such physical exhaustion, we may face a crisis due to the climatic effects of burning fossil fuels. When CO_2 is released from such combustion, some 50% remains in the atmosphere; the balance dissolves in seawater, or is taken up in enhanced plant growth. This atmospheric CO_2 traps heat by the greenhouse effect, raising surface temperatures. Figure 1 shows historical annual CO_2 production rates; Figure 2, measured increases in atmospheric CO_2 .

Wetherald and Manabe have used a three-dimensional general-circulation model of the atmosphere to determine the effect of doubling the atmospheric CO_2 level, as have other investigators. The consensus of opinion is that a mean temperature increase of 2° to 4°C would result, and that this increase would be amplified 3- to 4-fold in polar regions. It is widely believed that such an effect would produce broad shifts in patterns of winds and of rainfall. Even more serious would be a possible partial melting of the polar caps. Bretherton has stated the region of greatest risk would be the West Antarctic ice sheet (Figures 3, 4), whose underlying bedrock lies below sea level. Melting or disintegration of this ice sheet would raise worldwide ocean levels by 5 meters, inundating many coastal regions.

Siegenthaler and Oeschger have addressed the question of limits on future combustion of fossil fuels, in order not to exceed specified CO_2 limits. Figure 5 shows that if the CO_2 level is to be held to a 50% increase, there must be drastic reductions in fossil-fuel use early in the next century. An alternate scenario (Figure 6), in which all recoverable fossil fuels are burned, shows the atmospheric CO_2 level increasing tenfold by the early 22nd century.

Laurmann has noted that market penetration considerations limit the range whereby noncarbon-based energy sources can reduce fossil-fuel consumption. Figure 7 shows his curves for CO_2 increase, given that it takes 50 years or more for a new energy source to advance from 1% to 50% of the energy market. It thus is suggested that even today is none too soon to begin a major commitment to such noncarbon-based energy sources, if we are to avoid the potential consequences of a 21st century atmospheric CO_2 buildup.

It must be noted that study of these CO_2 effects is still in its early stages. In particular, Newell and Dopplick as well as Idso, using independent approaches, have recently proposed that a CO_2 doubling would produce only a 0.25°C global temperature rise -- an order of magnitude less than in the Manabe-Wetherald models. Much also remains to be learned about the world's ice sheets. However, one may conclude that even today, prudence would dictate due attention to non-carbon-based energy sources, including the power satellite.

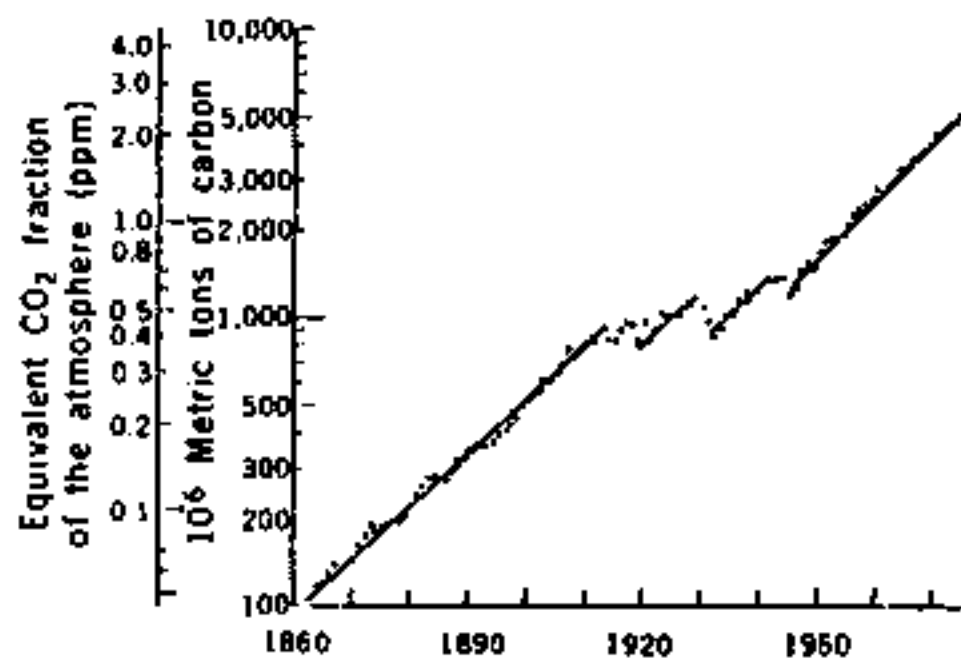

Figure 1. Annual production rate of CO₂ from fossil fuels between 1860 and 1974, as reconstructed from the production of coal, oil, natural gas, and cement. (After Broecker et. al., Science 206, 1979, p. 409)

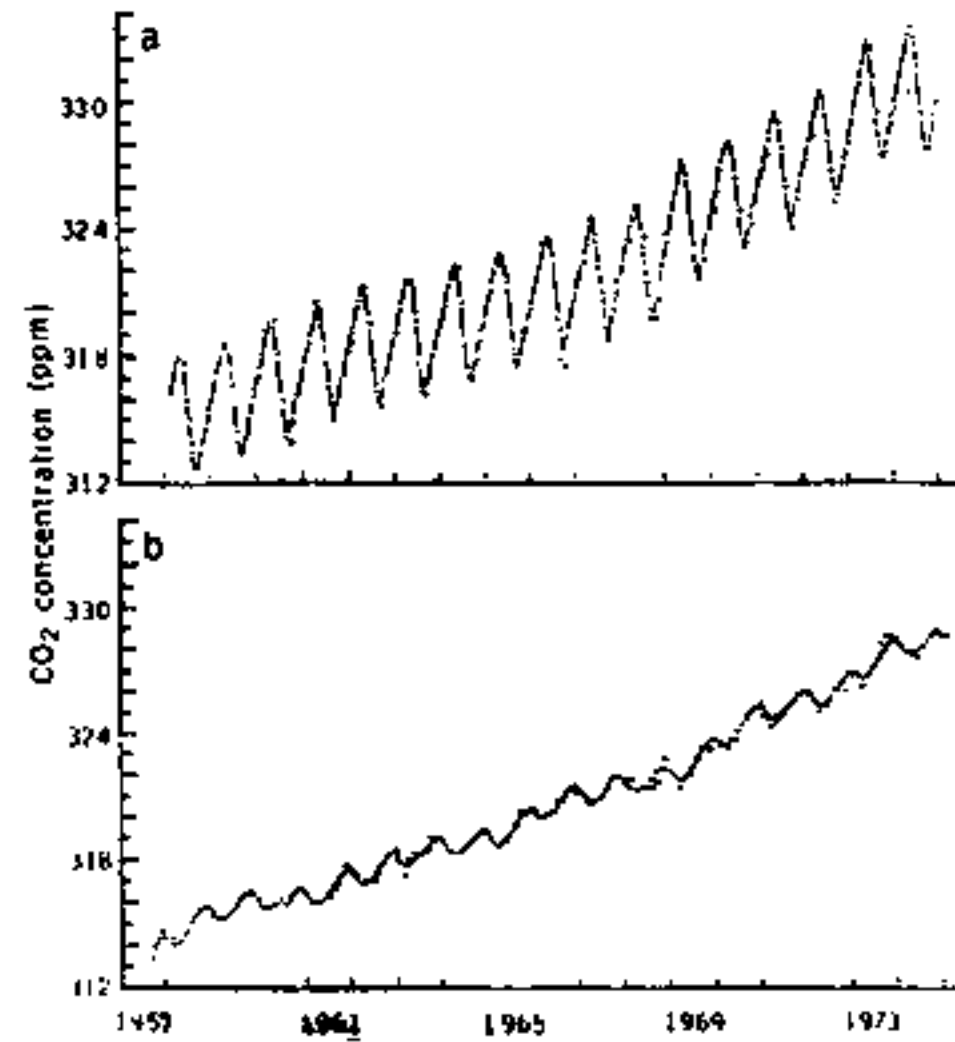

Figure 2. Measurements by Keeling and co-workers of concentrations of atmospheric CO₂ by volume in dry air, (a) at Mauna Loa Observatory, Hawaii, and (b) at the South Pole. (After Broecker et. al., op. cit.)

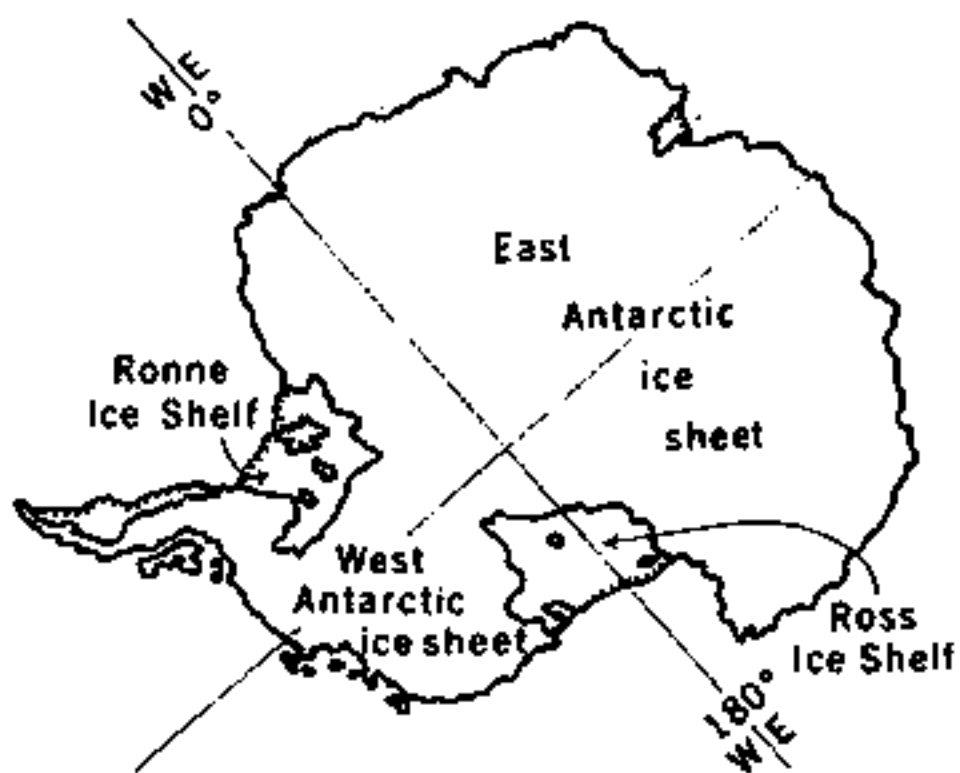

Figure 3. Antarctica, showing West Antarctic ice sheet and Ross Ice Shelf

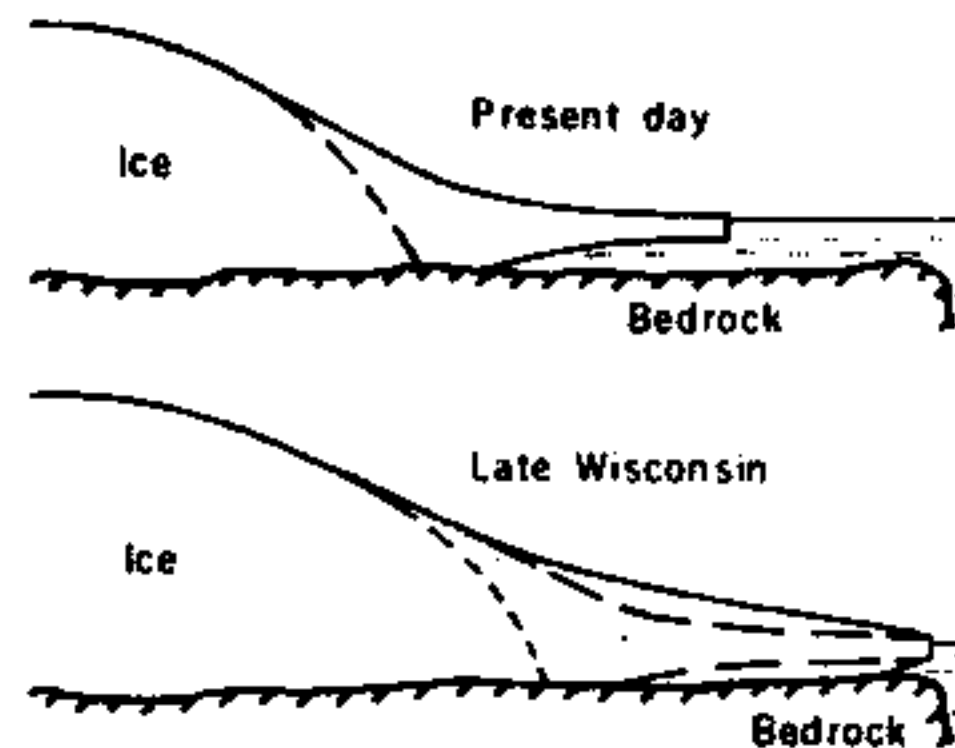

Figure 4. Schematic cross-section of West Antarctic ice sheet and Ross Ice Shelf. Top, present day. Bottom, during the height of the Ice Age (Wisconsin glaciation). In that earlier time, Ross Ice Shelf may have advanced (dashed curves) or may have frozen solid clear to the bedrock. (After Thomas, Science 205, 1979, p. 1257)

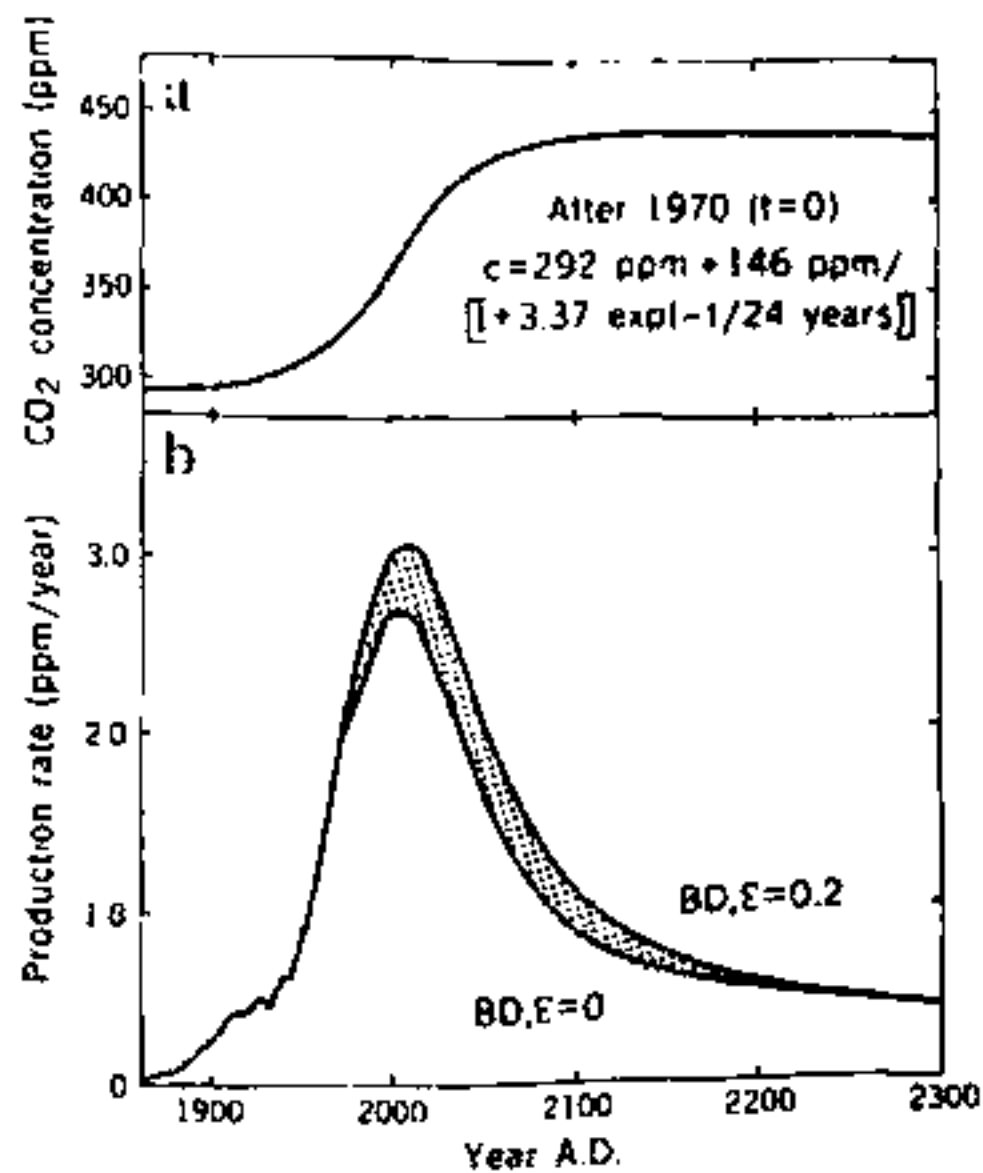

Figure 5. Carbon dioxide production rates as observed up to 1970, and as permitted after 1970 for an increase of the atmospheric excess in a prescribed way (a) to a maximum of 50%. (After Siegenthaler and Oeschger, *Science* 199, 1978, p. 388)

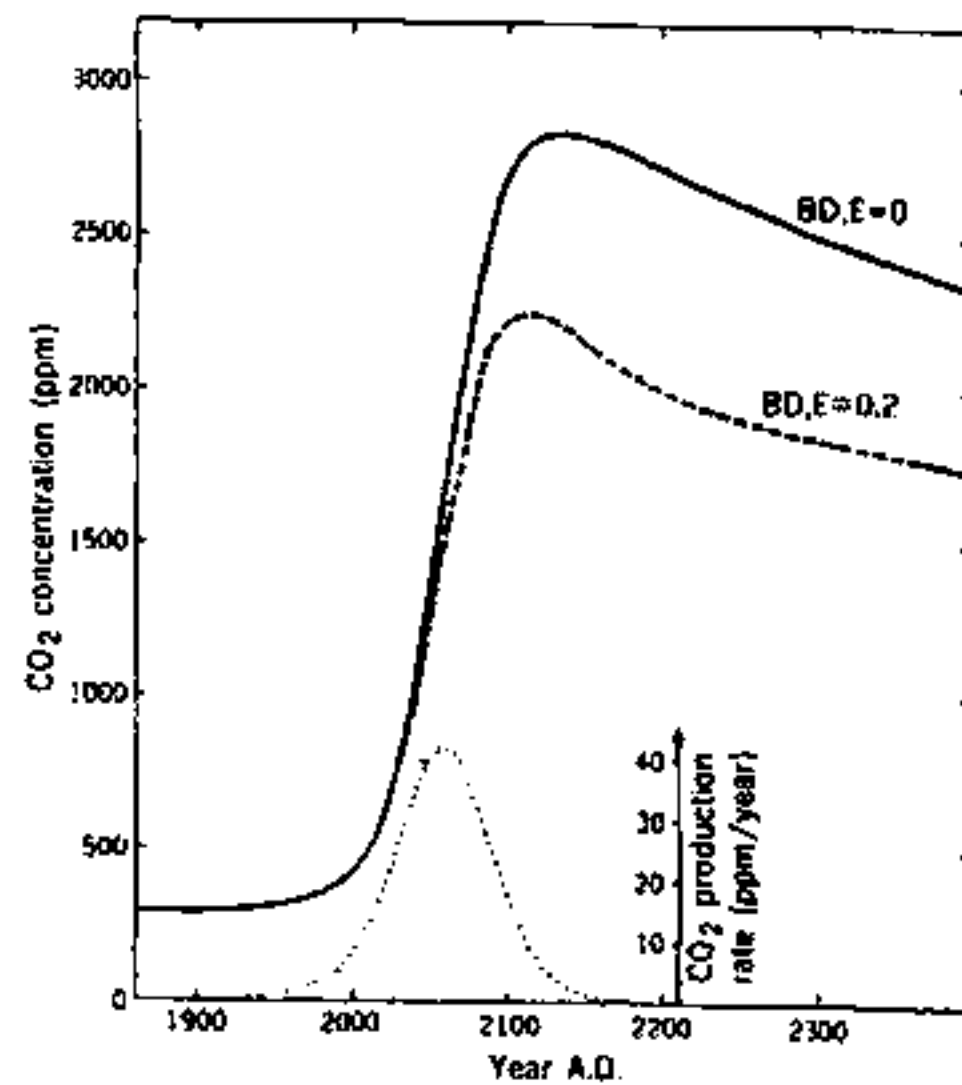

Figure 6. Predictions for the case in which all recoverable fossil fuels are burned. Lowermost curve shows resulting CO_2 production rate, if fossil-fuel use grows at 5% per year. The two CO_2 concentration curves reflect two models used; the dashed curve is regarded as less probable. (After Siegenthaler and Oeschger, *op. cit.*)

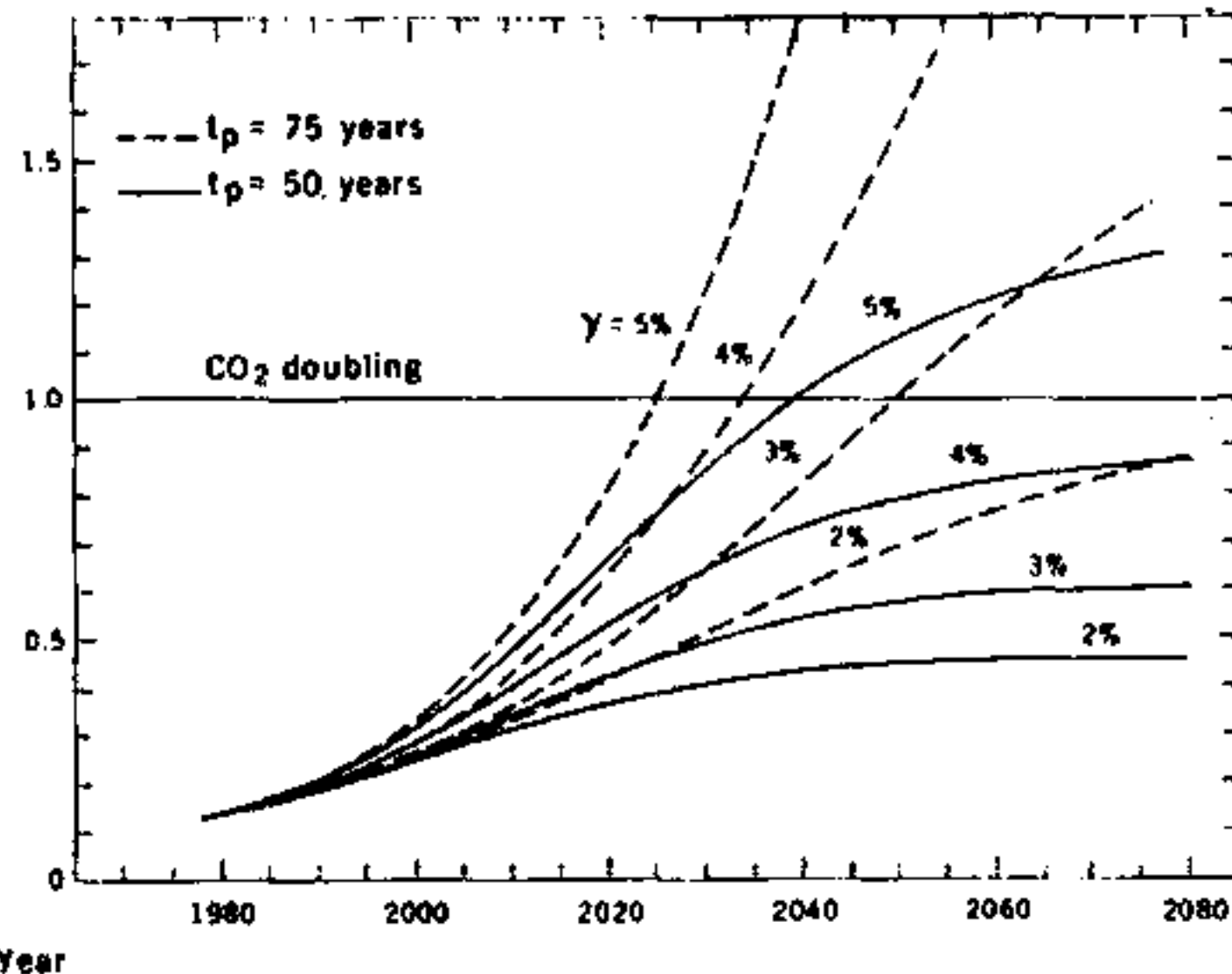
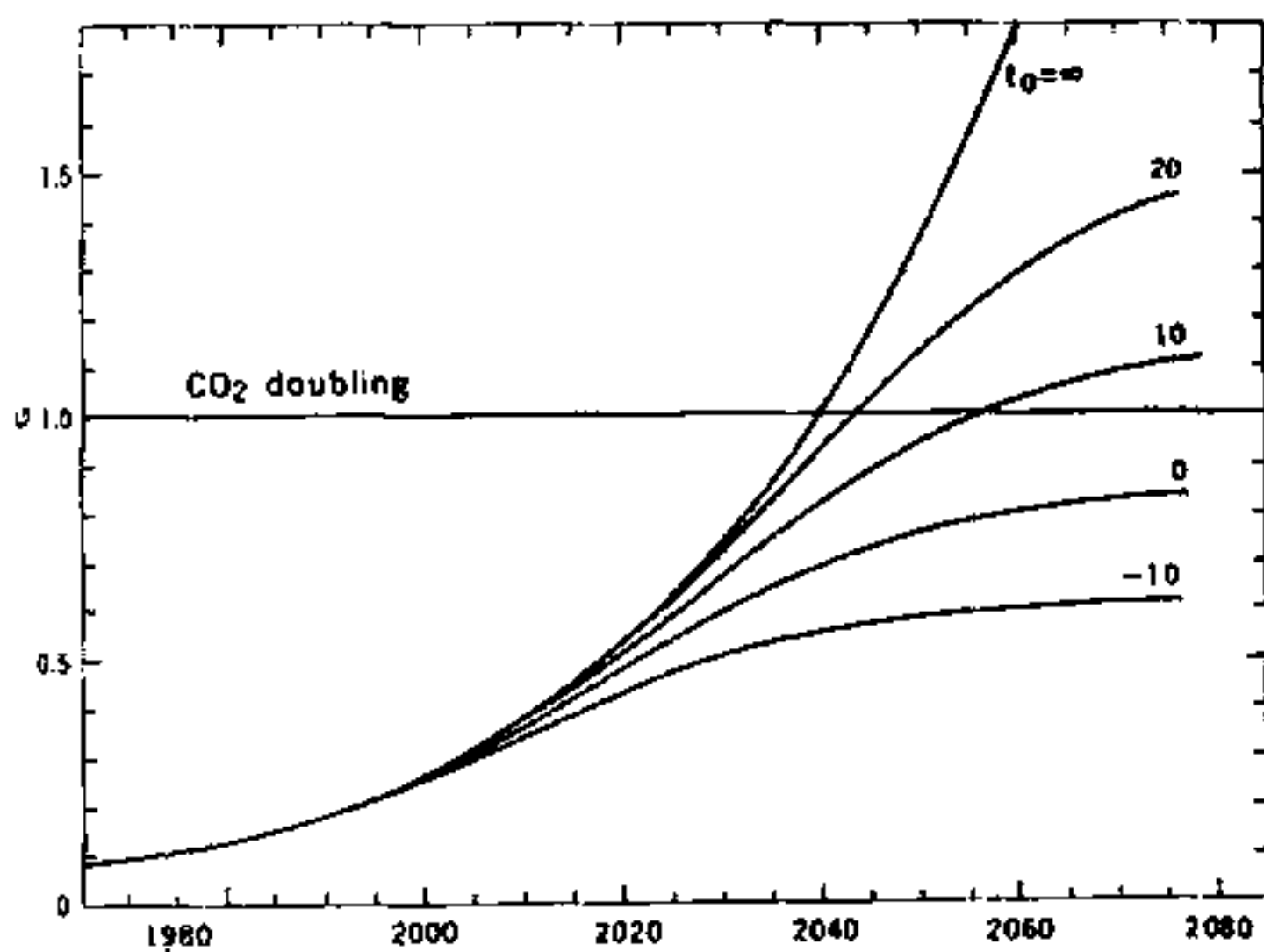

Figure 7. Left, fractional growth of atmospheric CO_2 concentration G above the preindustrial value for various initiation dates t_0 relative to 1975 of noncarbon-based energy, with world energy growth rate of 3% per year, and a market penetration time of 50 years (time for the new energy source to advance from 1% to 50% share of market). Right, fractional growth of atmospheric CO_2 for various annual world energy growth rates γ , and two market penetration times t_p . The 1% market share of the noncarbon-based fuel is taken to have occurred in 1965 ($t_0 = -10$ years). (After Laurmann, *Science* 205, 1979, p. 896)

ECONOMIC POTENTIAL OF SPS
Orlando E. Johnson
Boeing Aerospace Company

The Solar Power Satellite concept is a very simple solar power collection scheme in principle. However, it does require two large independent power processing stations. At the space-based station are solar cells which generate 0.8 Watts of power each. Aggregating enough of these cells by simple series-parallel electrical interconnections to be able to drive klystrons is basically all that is required. Each klystron requires about 80 KW of power (output of cells) in order to deliver nearly 70 KW of microwave power to the section of antenna that it drives. The second power processing station is on the Earth and it resembles the first station. Here, small dipoles (instead of solar cells) intercept the incoming microwave energy. They deliver 0.5 Watts of power each on average. The power from these dipoles must be aggregated, again by simple series-parallel electrical interconnections, to attain high enough levels to process efficiently and transmit to a utility company to sell.

The largest single element of cost in an SPS (Figure 1) is the cost of providing the extensive ground structures and equipment that are required for the receiving antenna.

Figure 1 - SPS COST

	<u>1978\$</u>	<u>%</u>
Ground-based Costs	\$4.1B	35%
Electrical Equipment	0.9	8%
Transportation	3.4	29%
Space Structures, Cells	<u>3.3</u>	<u>28%</u>
	\$11.7B	100%

For example, 2.7 Million, 9 x 30 foot panels supported on concrete posts are required. These are projected to cost \$0.6B. The 10 billion stamped metal dipoles (@ 5¢), 7 billion diodes (@ 4¢), wiring, switching and conventional power processing equipment come to \$2.2B. Adding all other costs, plus a liberal contingency allowance, brings total ground-based costs to \$4.1B.

The klystrons and power processing equipment that must be transported to space come to \$0.9B. This equipment plus the transportation itself are projected to cost \$3.4B. \$3.3B is allowed for solar cells, space structures and space assembly activities. Only this last amount, which is less than 30% of the total expected SPS cost, is for SPS elements that are largely new developments - in scale if not technology.

Would an SPS be competitive with conventional power? It depends highly on the assessment criteria adopted. For example, in the year 2,000, SPS systems are expected to cost \$5B more than comparable coal-fired plants. However, each SPS would eliminate over its 40-year lifetime the spending of \$40 to \$250 Billion for coal. If a comparative analysis is done in which the cost of fuel is highly discounted or fuel cost is excluded because it is an operating expense, not a capital cost, then the higher capital cost of the SPS will dominate the comparison. The SPS may then be rated as a less attractive investment in the eyes of an investor. However, as the coal plant is operated over its 40-year lifetime, the U.S. must forego \$25 to \$240 Billion in other consumption in order to provide the coal consumed. This means a lower U.S. standard of living and a diversion of several thousand U.S. workers from higher order employment into coal mining. These latter aspects of the SPS have not been clearly understood or

quantified in assessments completed to date.

Another way to compare the potential of the SPS to conventional power alternatives is to compare total lifetime expenditures required by each. For example, assume that SPS systems would cost \$2,340/KW if purchased now. Nuclear plants will be pegged at \$1300/KW and coal plants at \$100/KW.*

Figure 2 - CAPITAL INVESTMENT

	<u>COAL</u>	<u>NUCLEAR</u>	<u>SPS</u>
Plant Cost (S/KW)	\$1000	\$1300	\$2340
Cost Escal. (%/YR)	1.3%	1.9%	1.1%
Plant Factor (%)	.72%	.76%	.92%
Plant Cost	\$10.4B	\$17.4B	\$16.8B

If the given plants are 50% financed at 8.5% interest, earnings are 13.5% per year on equity investment and other capital costs are considered in a fashion typical of current utility operations (taxes, insurance, etc.), then the total capital-related costs for the three systems are as is shown in Figure 3

*If the real costs of construction materials escalate a little faster than inflation in general, and the regulatory costs for conventional plants continue to rise - higher for nuclear than coal - and using realistic operating factors for each plant (percent of time they may operate and deliver power), the total plant costs for each option come to the amount shown in Figure 2.

Figure 3 - LIFETIME COSTS

	<u>SPS</u>	<u>COAL</u>	<u>NUCLEAR</u>
Capital Related	\$63B	\$ 39B	\$ 64B
Fuel	0	105	93
O&M	<u>2</u>	<u>14</u>	<u>6</u>
TOTAL	\$65B	\$158B	\$163B
Cost/KWH	4.0¢	9.8¢	10.1¢

Adding the remaining costs, and dividing the total by the total number of kilowatt-hour generated (1600 x 10⁹ for all systems) yields the resultant average cost per kilowatt-hour stated. If the U.S. is successful in curbing inflation in the real costs of materials and fuels through the year 2000, the SPS cost advantage decreases. On the other hand, if inflation rises above the conservative trend projection assumed (due to depletion of

fuels, metals, and construction materials), then SPS systems should have greater economic promise than is suggested in Figure 3.

The achievability of predicted cost is generally viewed as a major SPS uncertainty. This is a valid issue that will not be resolved for some time. However, there are two factors of substantial importance that should stand in favor of respecting the present cost assessment. The first is that the majority of the SPS is, as stated earlier, simple panels, structure, wiring and very conventional electrical power processing equipment. Standard industrial costing practices are generally respected for pricing these kinds of things. Second, the fundamental

difference between the SPS and the other alternatives is fuel cost and this is clearly a large margin. SPS costs would have to be increased by \$100B (over the value shown in Figure 3) before the option is clearly not competitive with the given nuclear power cost projection.

A more graphic comparison of SPS economics is Figure 4. This figure illustrates the revenue that a utility may collect if allowed by a regulatory body to earn a 14.5% ROI. The revenue that must be provided by the utilities customers to operate a coal plant remains at around \$4B per year (or about 10¢ per kilowatt hour) over the plants entire assumed 40-year life (capital related costs decline as the plant ages, but fuel costs rise slowly and offsets all the decline because the real cost of coal is expected to rise as the most readily available supplies are depleted). SPS costs, on the other hand, decline because capital related costs dominate.

In actual service SPS installations may be longer lived than the 40 years assumed in Figure 3. Lifetimes of 75 to 150 years have been postulated as possible by some. If SPS systems are long lived then their economic advantage over coal-fired electrical generation increases substantially. In Figure 4 is such a comparison. The revenue required by each, if a 100 year lifetime for an SPS installation is assumed, is illustrated. In the last sixty years of operation SPS installations would require between \$2B and \$0.5B per year to operate while the coal plant requirements range between \$8B and \$14B per year.

Figure 3

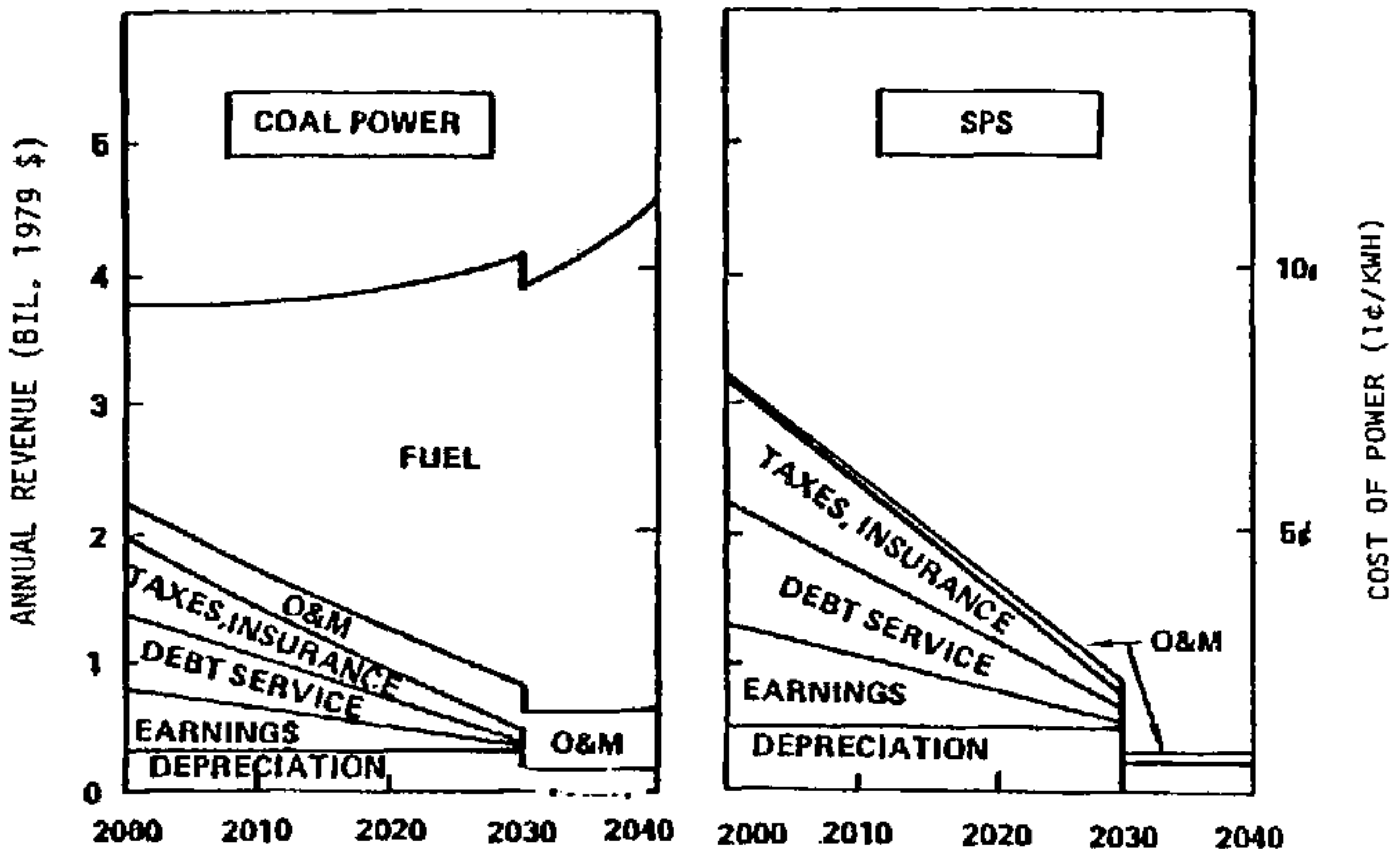

Annual Coal Plant Revenue

REAL COST ESCALATION RATES*
PLANT FACILITIES: +1.3% PER YEAR
FUEL: 6%/YR IN 1978 DECLINING TO 2%/YR BY 2020, 2%/YR AFTER 2020

REVENUE
 REQUIRED/YR
 -BILLIONS OF
 1978 DOLLARS

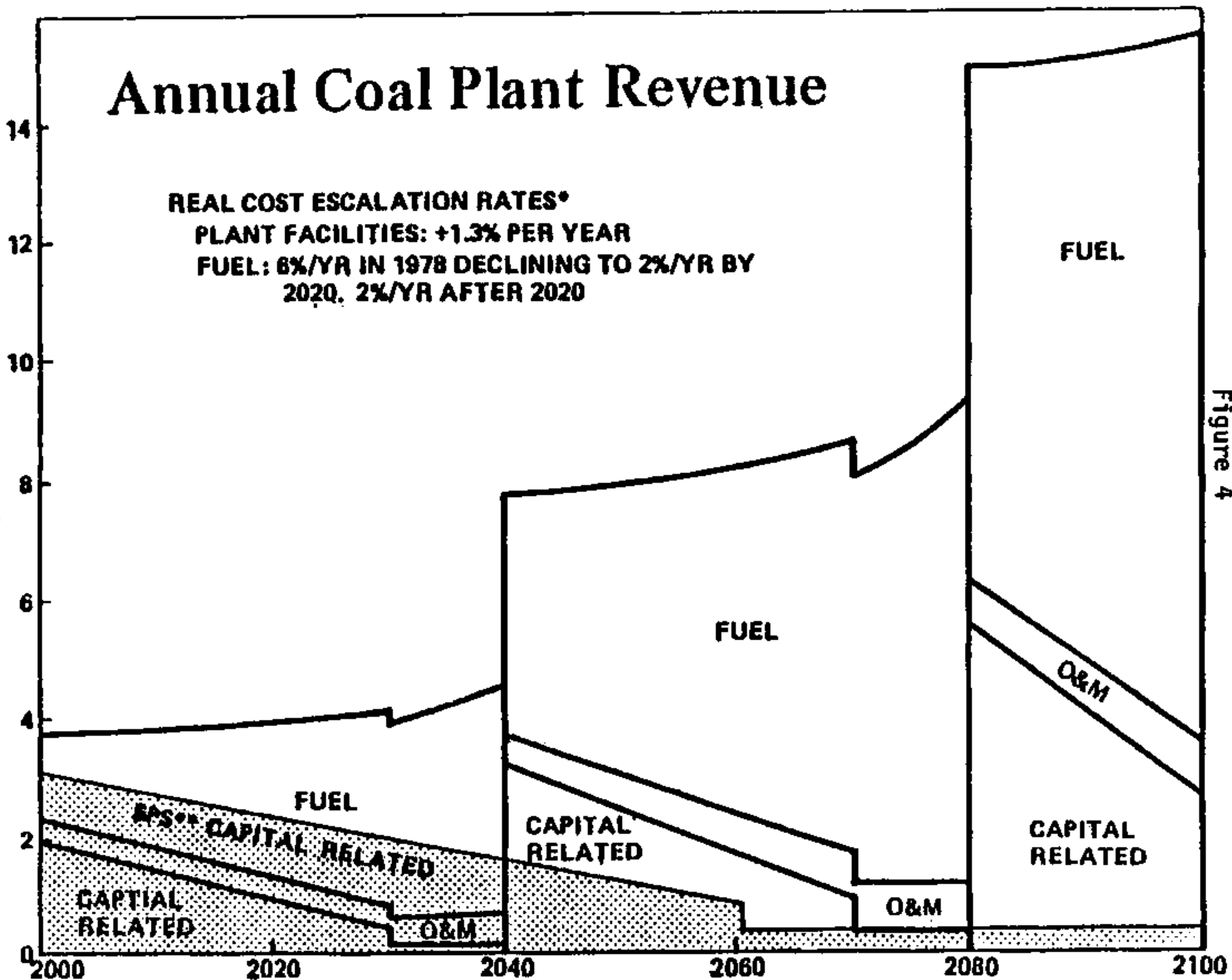

*ACTUAL COSTS WILL BE HIGHER BY RATE OF INFLATION THAT PREVAILS

Figure 4

SPS SALVAGE AND DISPOSAL ALTERNATIVES

George A. Hazelrigg, Jr.
Director, Systems Engineering
ECON, Inc.
Princeton, NJ

The satellite portion of the Satellite Power System (SPS) has a currently estimated lifetime of 30 years. The capital costs of the satellite less its net salvage value (gross salvage value less removal cost) must be amortized over that lifetime. To date, however, system cost and trade studies have been based on the assumption that the SPS satellite has zero net value at the end of that time. Many factors make this assumption inappropriate: many SPS components are replaced periodically and thus will be relatively new at the end of the 30-year satellite life; some SPS components will have lifetimes well in excess of 30 years; the SPS satellite may still be capable of producing substantial amounts of power, even in various states of degradation, that could prove useful to non-terrestrial applications; the SPS satellite represents a fairly large deposit of materials conveniently located in geosynchronous orbit; the SPS satellite represents a fairly sizeable source of refined materials that might be economically returned to earth for reuse.

The first SPS satellite will reach the end of its 30-year "useful life" at about the year 2030. Much sooner than that, about the year 2000, the Demonstration satellite will have completed its function and be available for other uses. As envisioned by Rockwell, the Demonstration satellite would be subsequently grown into a full-scale SPS satellite, thereby salvaging essentially the entire satellite, if the demonstration is successful. But it cannot be guaranteed that the demonstration will be successful--if it could, it would not be necessary. The importance of salvaging the demonstration satellite arises because it represents a very substantial cost incurred while there is still considerable uncertainty regarding successful SPS development and, thus, the SPS development program looks very much more economic if at least a major fraction of the Demonstration satellite costs do not have to be borne by the SPS program. Hence, it is important to find other potential uses for the Demonstration satellite as well.

In order to determine the value of either the Demonstration satellite or full-scale SPS satellites, it is necessary to first identify their potential salvage uses and second to quantify the "demand" for each use. This requires a space mission model for the post-2000 time period. It is, for all practical purposes, impossible to predict activities in space during the period, say, 2000 to 2060. Nonetheless, it does seem reasonable that certain generic trends can be identified, and that these trends are quite likely to occur. A basic premise is that many activities will be conducted in space simply because they are economic, independent of any government sponsorship. This leads to the conclusion that the demand for space-based capabilities will increase dramatically during the early 2000's. To accommodate this demand, space will become populated with fewer, larger spacecraft through a transition to large, multipurpose platforms. These platforms will be clustered in important orbits such as GEO and will represent very large investments, on the order of \$2-10 billion (1979\$). As a result, they will be serviced by a manned GEO station and are likely themselves to be manned.

Concentrating only on the GEO platforms, exclusive of SPS, it is likely that there will be 15-30 multimegawatt platforms by the year 2030. These platforms will generate a LEO-GEO traffic flow of 250,000-3,000,000 kg/yr plus propellants with the lower number more likely around the year 2000 and the higher number becoming more likely toward the year 2030. About two-thirds of this mass includes people, manned vehicles and logistics which must be transported relatively quickly between LEO and GEO. Thus, one use for the Demonstration satellite would be as a power source for a

laser LEO-GEO transportation system. Its value in this use derives from the present value of cost savings on propellants transported to LEO plus savings in cost of capital on items that would otherwise go by slower means--electric rocket--from LEO to GEO. A laser rocket would use about 70 percent less propellant than a chemical rocket and thereby produce a propellant savings on the order to 430,000-5,140,000 kg/yr. The marginal cost of transporting this propellant to LEO by means of the Space Shuttle would be about \$344 million-4.112 billion (1979\$) per year. With more advanced vehicles, this cost could possibly be an order of magnitude lower.

From the above arguments, it is clear that use of the Demonstration satellite as a power source for a laser LEO-GEO (and possibly to other orbits or to earth escape) transportation system would have a present value, referenced to the year 2000, on the order of several billion dollars. Thus, it is suggested that this satellite be equipped with a laser suitable for both demonstration of the laser SPS concept and for powering laser rockets. With other potential "salvage" uses of the Demonstration satellite, such as power production, it becomes apparent that the effective cost of the Demonstration satellite is only a fraction of the cost of the microwave transmitting antenna. Thus, it is also recommended that the Demonstration satellite be used for these salvage purposes after its use as an SPS demonstration rather than being grown into a full-scale SPS satellite. Only the transmitting antenna should be salvaged for use on the full-scale SPS satellite.

It is important to recognize that the above salvage value of the Demonstration satellite can dramatically alter the economic value of the SPS development program by effectively allowing a large fraction of the cost of the Demonstration Phase of the SPS development program to be borne by other programs.

It is far more difficult to find relatively firm salvage uses for full-scale SPS satellites some half-century and more in the future. Nonetheless, there are some intriguing possibilities. One is to provide a power source to retrieve Amor asteroids for mining in earth orbit. This use could potentially provide a vast source of resources in earth orbit for space manufacturing, space habitats and for supplementing terrestrial resources, such as gold and platinum. A second use is as spare parts for other SPS satellites. It could also serve as much of the material necessary for a new SPS satellite.

In any case, it should be recognized that there is a practical limit to the salvage value of any SPS satellite or component. This limit is the cost of replacing the SPS satellite with a new SPS satellite at the end of its useful life. Thus, for example, if the cost of replacing an SPS satellite at the end of its useful life is, say, 70 percent of its new cost (due to learning during its 30-year useful life) and the real discount rate is taken to be 4 percent per year, the "maximum" salvage value of the SPS satellite would be about 22 percent of its initial capital cost. It is possible, but unlikely that the salvage value would exceed this amount. It would exceed this amount only if the satellite were constructed of rare materials, such as gold, which could appreciate considerably over 30 years due to their scarcity value. These same limitations apply also to the Demonstration satellite.

It is concluded that salvage uses of the Demonstration satellite have a value sufficient to offset most of its cost. Salvage uses of full-scale satellites are harder to predict, but it appears reasonable that the present value of their salvage uses referenced to the initial operation date of the satellite will be in the range of 10-20 percent of the satellite capital cost.

THE SATELLITE POWER STATION AND NON-COST UNCERTAINTY ASPECTS OF RISK

Mark M. Hopkins

The Rand Corporation, 1700 Main Street, Santa Monica, California

An important factor in the determination of the risk of an investment in a novel technology is uncertainty in the estimated production costs. This has been emphasized in past risk analyses of Satellite Power Stations (SPSs). But there are other important aspects of risk that have been neglected.

For instance, the relative risk of two options depends on the expected cost of the energy produced as well as upon uncertainties in these costs. Thus, options which involve relatively high cost uncertainties may have less risk because of lower expected production costs.

The attached figure provides prices projected to the year 2000 for alternative energy sources. The reference version of the SPS (current baseline) is risky in part because of its relatively large range of cost uncertainty. This high uncertainty is a reflection of the early stage of the program and can be expected to decrease as the program continues. A more serious problem is the risk due to the possibility that an SPS may not be able to compete with other types of energy sources. Indeed, if the graphs are taken literally there is zero chance of an SPS being competitive with coal in the year 2000.

What is needed is an effort to find an alternative SPS design which shows promise of providing lower production costs. Possibilities include solid state components, lasers for energy transmission, multicolor solar cell systems, solar pumped laser satellites and the use of components built to a large extent from lunar materials.

The only readily available cost comparison study of a reference SPS and a major alternative SPS design is the LRU (Lunar Resources Utilization) study by General Dynamics. The intention in using data from that study is not to advocate the LRU SPS; but rather to demonstrate that there is a reasonable possibility of the existence of an SPS approach which is obviously riskier in terms of cost uncertainties and yet at the same time has lower overall risk because of lower expected production costs.

Calculations which utilize the General Dynamic data indicate that LRU SPS electricity would cost two-thirds as much as electricity generated by a reference SPS. Assuming, for illustrative reasons, that this two-third factor can be applied to the best estimate of the cost of electricity for the reference SPS in the attached figure, we obtain a best estimate for the LRU SPS option which is very near the best estimates of the cost of the least expensive alternatives in the attached figure--coal and nuclear. Hence the risk of not being competitive for this SPS option may be substantially smaller.

If the SPS RDT&E program is run by a governmental agency, such as DOE or NASA, then there will be risk with respect to these agencies, which in general is not the same as risk with respect to society--the type of risk which was of concern in the preceding. Indeed, the net advantages of the high technology--high uncertainty--low production cost approach is often greater for such organizations. Their crucial source of risk is not cost uncertainties, rather it is the possibility of program cancellation (due to lack of economic viability) after a large amount of money has been spent purchasing such items as the first SPS. The political repercussions of a program cancellation under such circumstances for an agency such as NASA could be enormous.

The SPS and fusion concepts have many similarities. Both involve high technology, large centralized power sources, and the potential of providing almost all of our energy needs far into the future. The fusion program does not currently have a reference design which is economically feasible. The

program thus pursues several options, hoping that one of them will eventually become economically viable. It is the author's view that the SPS program should conduct itself in a similar manner. In this way the risk of not being competitive after having made a sizable investment can be substantially reduced.

The economics of fusion (which are indicated by the attached figure) are generally worse than those of SPSs. Further, the potential environmental impact of fusion is not obviously better than that of the SPSs, and could be much worse. These considerations, along with those mentioned earlier, suggest that funding for the SPS program should not remain at a value which is almost two orders of magnitude less than that which goes to fusion. Instead, it suggests that the funding for SPSs should rise at a judicious pace until it at least approaches the funding level for fusion.

Another aspect of risk concerns the effect on society's energy portfolio of adding a new option. This will generally reduce the variance (a good measurement of risk) of the expected price of electricity. Measuring the extent to which SPS does this is (given existing long-run energy models) a doable and exciting project which has yet to be done.

Additional aspects of risk are discussed in the text of the paper.

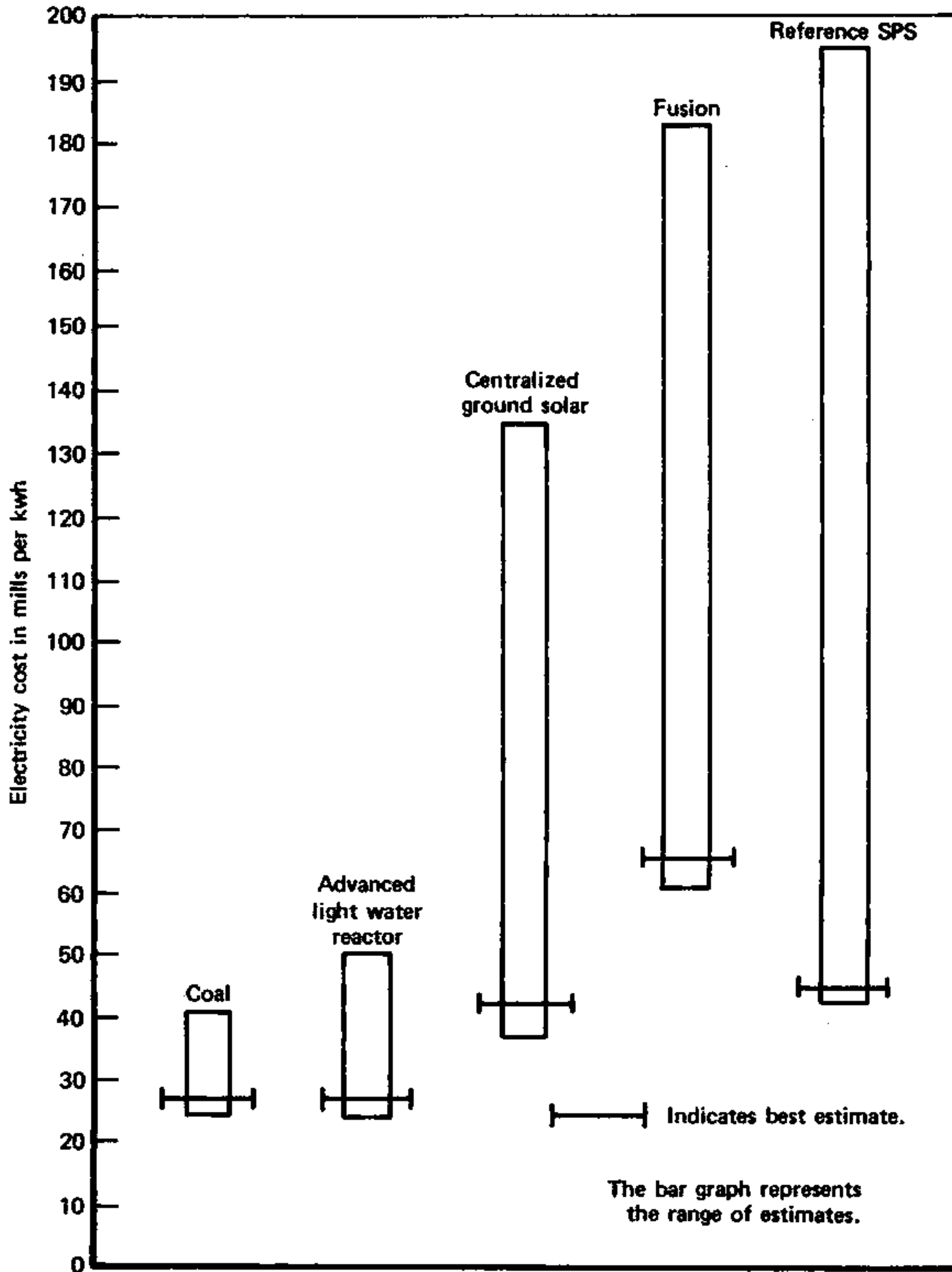

DATA SOURCE: Preliminary (April 2, 1980) results from Argonne National Laboratory.

Projected prices of alternative energy sources for the year 2000 in 1978 dollars

SPS: THEIR FINANCING AND MACROECONOMIC EFFECTS
Robert S. Block
734-3820 Locust Walk - High Rise East
University of Pennsylvania, Philadelphia, Pennsylvania 19104

Any financial decisions concerning SPS's would have many effects on my generation. My concern with the SPS project focused on the profitability of the project, the source of the capital for the project and the macroeconomic effects of the capital flow.

I based my calculations for the profitability of the SPS project on the 1977 Boeing Baseline Reference System. Thus I assumed construction costs of \$24.75 billion incurred evenly over the four years of construction, yearly maintenance costs of \$328 million incurred over the thirty-year life. Revenue received each year was the percent of solar cells still operational times 10 Gw times 8760 hours per year divided by 1000 to give 8.76×10^{10} kwh per year times percent of solar cells still operational. The tax rate for the private sector was assumed to be 40%. The cost of capital to the project presented a special problem. Cost of capital is directly related to risk. Historically, the return to capital in the stock market has been 9%. Since this project is somewhat riskier than the average of the stock market, I felt a good and reasonable cost of capital to be 12%. I also computed my profitability model based on costs of capital of 9% and 15%. The model I used to compute the profitability of the project was its net present value. The present value of the cash inflows are subtracted from the present value of the cash outflow. If the result is positive then the project is profitable. If the result is negative then the project is unprofitable. I considered the net present value for private industry and government ownership. For both private industry and government the outflows are the construction costs and maintenance costs. These are discounted back to the present. The inflows for private industry are the after-tax revenue each year, the after-tax savings on the amortization of maintenance costs and the tax savings from the depreciation of construction costs since it is tax deductible. For government the only inflows are the revenues since there is no amortization, depreciation or taxes. The inflows are then discounted back to the present to get their present value. In performing the net present value I varied the inflows by varying the rate charged per kwh in the revenue calculation. I was interested in several things: Is the venture profitable, at what level is the project profitable and where does the government ownership become more profitable than private ownership because of taxes. I was more concerned with whether or not the project was profitable rather than the exact magnitude of profitability.

At a discount rate of 12% the project yields a profit of \$28 billion at a charge of 4¢/kwh which is the level of rate charges now in the electrical industry. The projects are equally profitable at 29¢/kwh. It seems then that private industry provides the greatest profitability for this project. (See Table 1). As can be readily seen if the cost of capital becomes lower than 9% then governmental ownership becomes more feasible.

I next sought to determine where the capital would come from for the project. Private industry could sell stock or float bonds. However, it seems highly improbable that any private company would be able to obtain equity or lever itself to the sum required for the project. This is especially true when one considers that much of the financing is front-end. It seems, then, that govern-

ment financing is necessary. Once again, though, there could be problems here because of the balanced budget sentiment in the country now and inflationary effects of deficit spending. One promising source of capital which requires much more study is the public utilities. The amount of funds that the public utilities spend on new construction each year is far greater than the amount that is depreciated each year. This is a large source that it may be possible to tap. (See Table II.)

The final topic I considered was the macroeconomic effects of financing and construction. The IS-LM model (Table II) shows the disturbances to the economy in terms of GNP and interest rates. Competition of SPS's for funds in the financial markets will raise interest rates (LM') causing GNP to temporarily fall. Eventually, once the SPS becomes operational and revenues flow, the good market shifts (IS') causing interest rates to fall and GNP to rise. If funds are externally provided (government) then interest rates will not change much but GNP would rise. This may very well be inflationary though.

Another source of inflation occurs in the construction phase. If workers are not shifted from other sectors but rather new jobs are added to the economy then overemployment may occur. This would bid up all wages causing cost rises which would cause price pass-throughs causing a rise in inflationary expectations. This is a mixture of demand-pull and cost-push inflation leading to an inflationary spiral.

SOLAR POWER SATELLITES: THEIR FINANCING AND MACROECONOMIC EFFECTS
 ROBERT S. BLOCK, 734-3820 LOCUST WALK
 UNIVERSITY OF PENNSYLVANIA, PHILADELPHIA, PA 19104

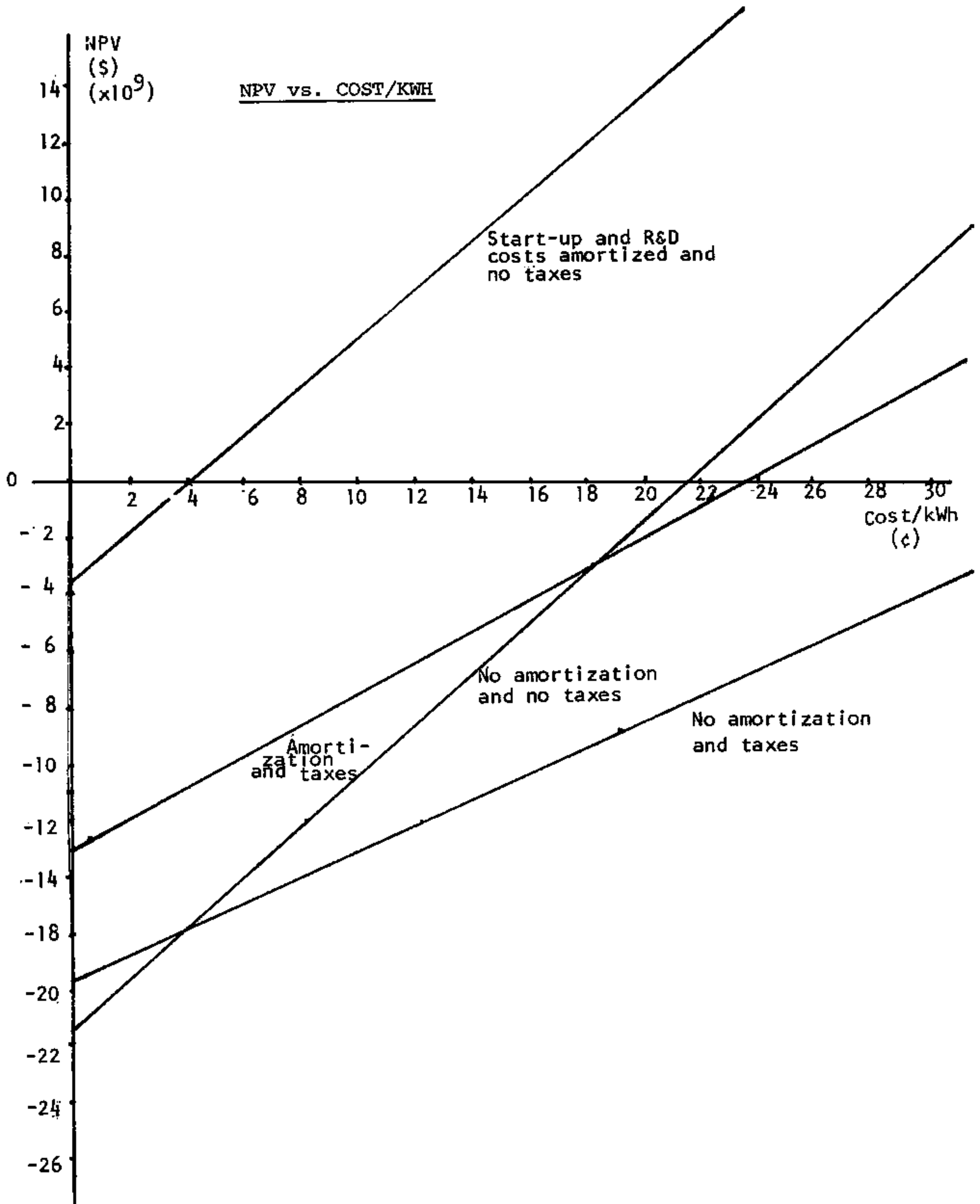

SOLAR POWER SATELLITES: THEIR FINANCING AND MACROECONOMIC EFFECTS

ROBERT S. BLOCK, 734-3820 LOCUST WALK
UNIVERSITY OF PENNSYLVANIA, PHILADELPHIA, PA 19104

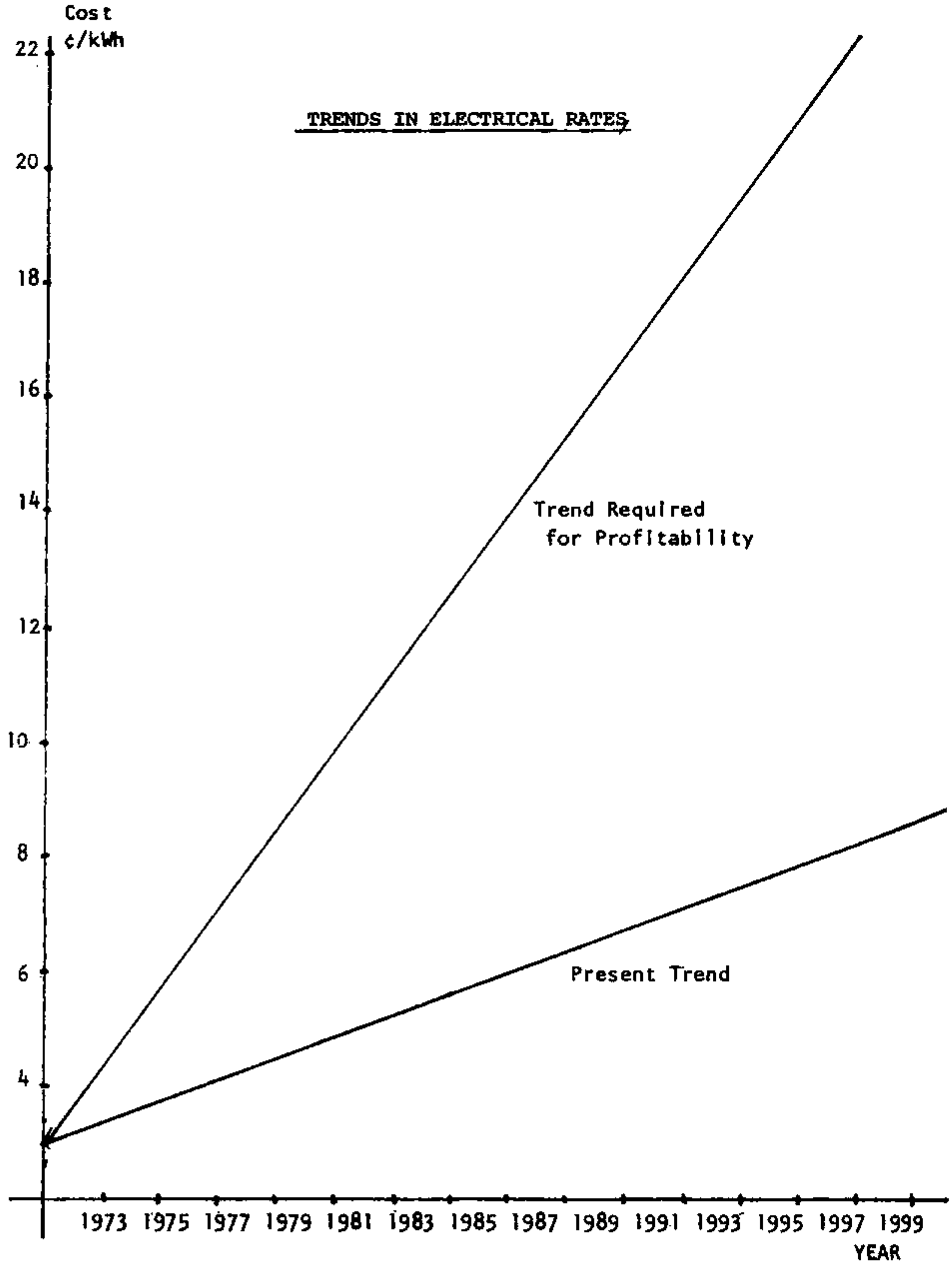

RESOURCE COMPARISONS (LAND, WATER, AND MATERIALS)

William B. Wilson

Teknekron Research, Inc. - 1483 Chain Bridge Road - McLean, VA 22101

This paper compares and evaluates the land, water, and material requirements of eight energy systems: coal w/FGD, coal gasification c/c, light water reactors, liquid metal fast breeder reactors, centralized and decentralized photovoltaic solar power systems, and satellite power systems (SPS). The assessment involves both a side-by-side comparison of the eight energy systems -- normalized to 1250 MWe of capacity -- and an alternative future analysis in which the resource requirements of the technologies are evaluated across time.

Normalized to 1250 MWe, the coal and SPS fuel cycles require the most land: 13,600 and 15,000 acres respectively. Terrestrial photovoltaic solar systems also require large quantities of land. Except for fusion, the nuclear fuel cycles need large contiguous land areas for the disposal of high-level radioactive wastes (some 2,000-18,000 acres) but when this requirement is normalized 1250 MWe, the land impact is small. The decentralized photovoltaic solar system (i.e., the roof-top system) requires almost no land because it makes use of land already in use.

The alternative futures analysis revealed that development of the coal and SPS technologies will considerably increase the amount of land that must be allocated to the production of electrical power (see Figure 1). For example, a 300 gigawatt SPS system would require some 3.6 million acres of land; this would be approximately a third less if SPS was used to replace coal power plants rather than nuclear. In addition, it may be possible to offset this impact by utilizing lower quality lands for rectenna sites, offshore siting, and multiple uses of the sites.

The coal and nuclear fuel cycles require several orders of magnitude more water than any of the photovoltaic technologies (see Figure 2). Water pollution is a relatively insignificant problem with the steam technologies but evaporation losses are critical and limit the siting of coal and nuclear power plants in water short areas -- mainly the West.

Under the alternative futures analysis, water requirements for all the steam fuel cycles more than doubled. However, the development of SPS considerably reduces the estimated quantity of water required to produce electrical energy -- by more than that currently used today to produce electrical power. Hence, SPS offers large potential benefits to water short areas; the same areas for which it is also advantageous for other reasons (i.e., high insolation, the presence of large contiguous land areas, and the relative availability of lower quality land).

The side-by-side assessment of material requirements showed that all fuel cycles must rely -- to varying degrees -- on imported materials. However, in the near term, materials are not a significant issue since U.S. reserves are adequate to meet the demand. In addition, the alternative futures analysis concluded that all the fuel cycles under consideration may encounter future material problems, especially with respect to aluminum, chromium, gallium, nickel, silver, and tungsten. The major constraint is production (i.e., competition from competing users) rather than availability; the effect of import reliance is uncertain.

Figure 1

Summary of Total Land Requirements by Scenario

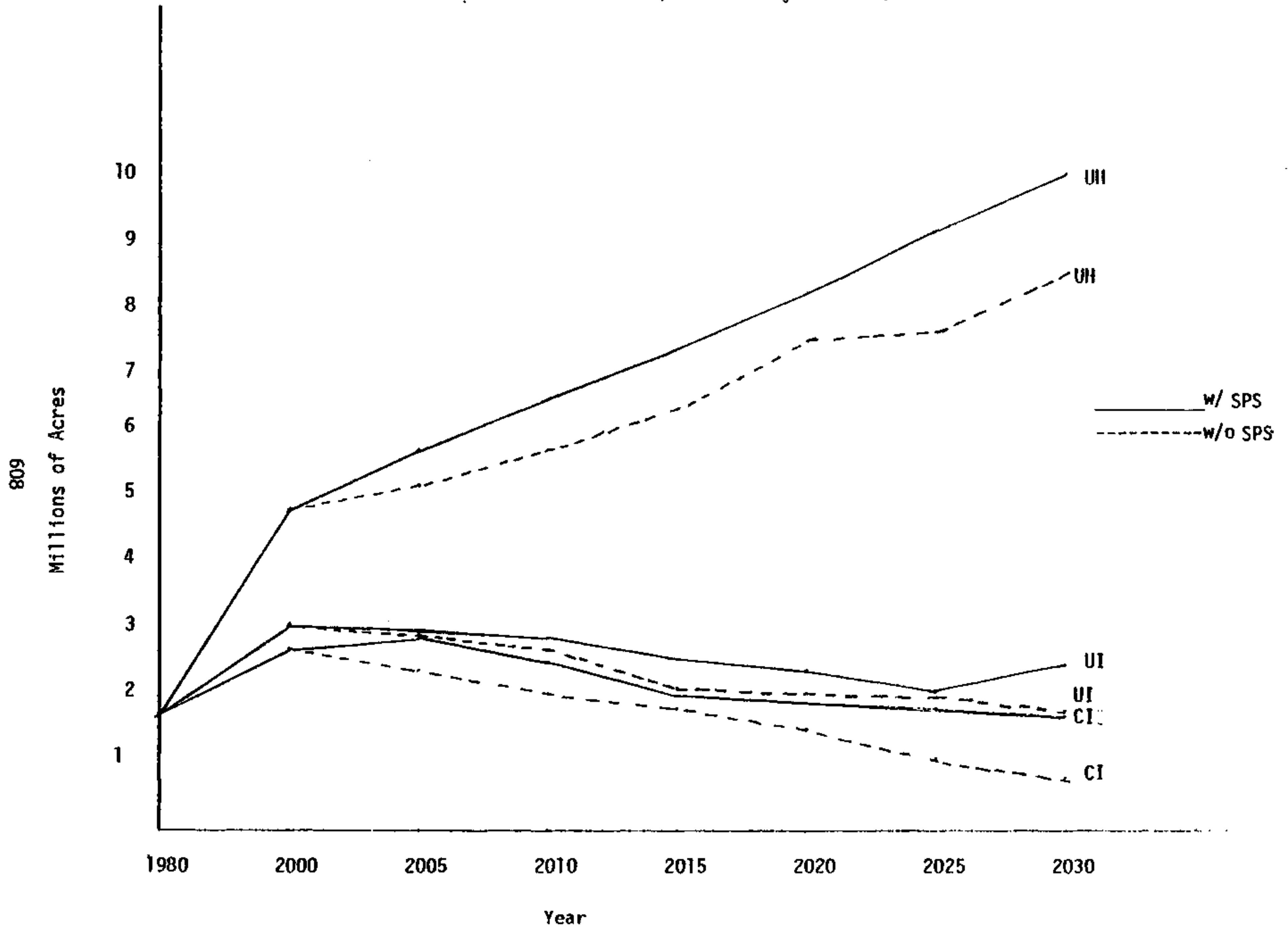
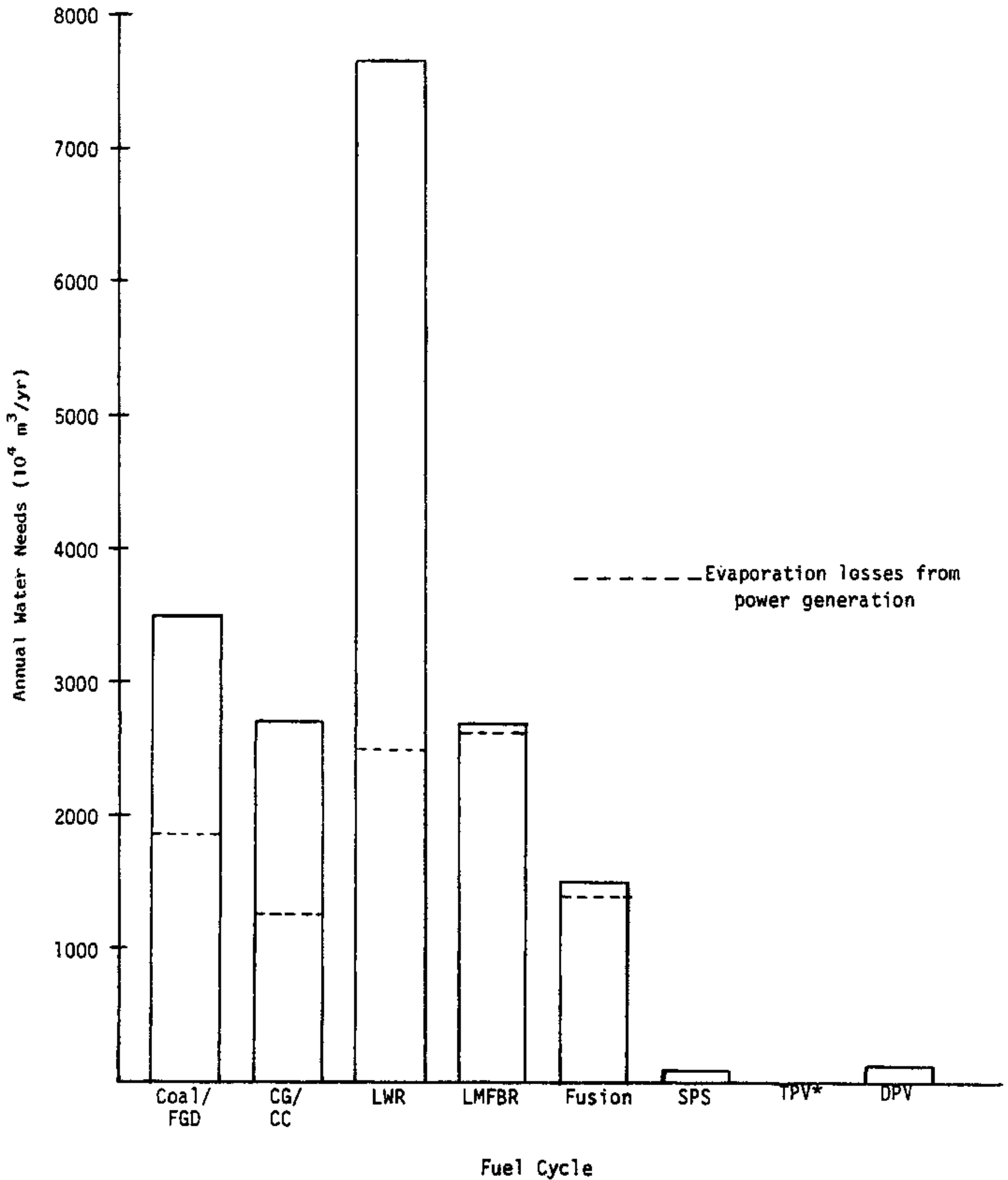

Figure 2
SUMMARY OF ANNUAL WATER REQUIREMENTS



*TPV uses $1.5 \times 10^4 \text{ m}^3/\text{yr}$

MACROECONOMIC/SOCIOECONOMIC COMPARISONS OF SPS
AND ALTERNATIVE ENERGY TECHNOLOGIES

R. U. Ayres
Carnegie-Mellon University

Macroeconomic impacts are measured by changes in GNP and its major components, unemployment rates, and inflation rates, attributable to alternative technologies, indirect system dollar costs include infrastructure, residual pollution, resource, and monetary welfare costs that could affect the economy. Certain economic effects (e.g., employment) are likely to be more pronounced at the regional than at the aggregate national level.

The principal macroeconomic issue is: What effects will deployment of SPS or its alternatives have on the national economy of the 21st century? The impact of SPS clearly depends on the prevailing economic environment in which it is superimposed. In particular, the key questions are: What is the overall demand for energy? What is the pattern of demand (i.e., central electricity vs. other forms)? What will electricity cost if produced by conventional technologies? What impact would SPS have on the projected cost of electricity?

Overall, demand for energy at any given time is acknowledged to be related to the level of economic activity (GNP). Of course, the changing "mix" of services and heavy industry in the economy has altered this relationship over time. Moreover, rising energy prices can be expected to alter the relationship further in the direction of encouraging conservation by substituting capital or labor for energy as a factor of production.

A related issue is the likely effect of rising energy prices on productivity and GNP growth. Qualitatively it is clear that higher energy prices must have some drag effect on productivity, because capital that would otherwise go to increase output per unit of labor (i.e., to increase labor productivity) will be diverted to reducing energy inputs or developing substitutes to replace high-cost imports.

The consensus of most economists today is that the historical, 3.3% p.a. U.S. growth rate of the 1950-1975 period will drop to less than 3% for the next several decades. Economic projections assuming a 2.8% p.a. growth rate between 1989 and 2000 and 2.3% p.a. after the year 2000 imply rates of capital formation and savings significantly higher than the U.S. has experienced in the past 20 years. If these higher implied rates of capital formation are not achievable, a growth rate even slower than that postulated above will be the result. Thus, the suggested 2.8%-2.3% GNP growth pattern for the period 1980-2030 is, in all probability, an upper limit of what can be achieved.

Unfortunately, international petroleum supplies are politically determined and the prevailing climate suggests that the level of imports cannot be expected to rise much, if at all, over present levels. Thus new or replacement sources of energy for the U.S. must be found domestically. The four scenarios discussed hereafter are predicted on variations of this basic theme. The four scenarios are as follows:

- UI Unconstrained, Intermediate energy intensity
- CI Constrained, Intermediate energy intensity

- CI(d) Constrained. Intermediate energy intensity (decentralized)
UH Unconstrained, High energy intensity.

Because of differing assumptions about production constraints and long-run costs, the scenarios yield significant different long-run price trajectories for all primary fuels, as well as electricity.

It can be shown that the assumed rate of deployment of SPS after 2000 would make SPS the dominant source of central station electricity by 2030 for all of the scenarios except UH. One consequence of this would be to eliminate the impact of assumed production constraints for coal and nuclear power. Thus the cost of coal and non-SPS electricity in scenarios CI, CI(d) would presumably drop back to the levels of UH and UI. A lower price of coal would, in turn, reduce the cost of syngas and, consequently, the price of natural gas would also drop back toward the unconstrained level. Thus, though SPS is a more expensive means of generating electricity, it would relieve shortages of other fuels in the most probable (constrained) scenario and reduce their prices correspondingly. SPS will increase direct costs to electricity users. The impact might be concentrated on a specific area (such as New England) where other sources of electric power are scarce. Or it might be spread over all electricity users by various mechanisms --especially if a "national grid" exists by that time. Only if the extra cost is spread over all regions is large-scale deployment of SPS likely to occur, since the major benefits are indirect, and beneficiaries (e.g. syngas consumers) might be in different regions.

The second major macroeconomic problem associated with SPS arises from its large appetite for scarce capital. The "extra" investment required to build 10 GWe of SPS per year after the year 2000 --as compared to the cheapest alternative (coal)-- would be in the range of \$20-\$50 billion, or 10-25% of the investment increment dedicated to economic growth. It could apparently cut potential GNP growth rates below the target level of 2.3% by 0.2% p.a. to 0.5% p.a.

It must be acknowledged that numerical calculation of this kind are predicated on so many uncertain factors that very limited weight should be placed upon them. It is probably enough to say that the capital demands of SPS would probably hold back real economic growth to some degree, relative to the "cheapest" alternative sources of electric power.

Not much more can be said at this stage about local or regional impacts, or effects on specific social groups or classes.

ENVIRONMENTAL WELFARE EFFECTS EVALUATION

William B. Wilson

Teknekron Research, Inc. - 1483 Chain Bridge Road - McLean, Virginia 22101

Broadly defined, welfare effects are adverse environmental impacts (excluding health and safety related impacts) on the well-being of individuals, society, and the environment. Welfare effects result from environmental residuals released by the processes and activities involved in the production of electrical energy and from various fuel cycle operations and activities themselves. This paper presents a comparative assessment of the welfare effects associated with the satellite power system (SPS) and seven alternative energy technologies.

Six categories of welfare effects are examined: (1) economic losses (i.e., property and material damage, reduced crop yields, and lowered property values); (2) climate and ecosystem changes (i.e., CO₂ buildup, degradation of terrestrial and aquatic habitats, and interference with wildlife migratory patterns); (3) nuisance impacts (i.e., noise, fugitive dust, localized misting/fogging/icing conditions, and the lowering of area water tables); (4) aesthetic losses (i.e., reduced visibility and adverse visual impacts); (5) electromagnetic disturbance (i.e., interference with communication signals, computer operations and/or medical devices); and (6) other social costs (i.e., reduced water quality, reduced commercial/recreational use of public water bodies, pre-emptive land uses, aquifer interference, degradation of roads/highways, and congestion of transportation systems).

An exhaustive literature search and an extensive number of contacts with outside experts revealed that the welfare effects associated with conventional fuel cycles (e.g., coal and LWRs) are better understood and documented than those associated with the more advanced fuel cycles (e.g., SPS and fusion). Furthermore, the welfare effects of the advanced fuel cycles are characterized by a larger degree of uncertainty, although uncertainty is a characteristic of most research on this topic.

Based on available data, the most serious welfare effects identified were associated with coal (i.e., acid rain and CO₂ buildup) and nuclear power (i.e., radioactive wastes). The welfare effects thought to be produced by SPS include electromagnetic interference, pre-emptive land uses, and aesthetic impacts; however, considerable research is needed to document the extent and significance of these problems. Moreover, most of the welfare effects produced by the SPS fuel cycle are ones that are generally acceptable when produced by other fuel cycles (e.g., aesthetic losses) or of unknown acceptability (e.g., electromagnetic interferences).

Projections of welfare effects across time are made difficult by the large degree of uncertainty associated with their cause-effect relationship and inadequate data. Nevertheless, it did appear that SPS would have a positive effect on some of the more serious contemporary welfare effects associated with the production of electrical power, namely acid rain, CO₂ buildup, and the production of radioactive wastes. SPS's overall impact on such problems however is impossible to estimate without a great deal of further research, because the scope of these issues transcend both the production of energy and national boundaries.

CLIMATE AND ENERGY: A COMPARATIVE ASSESSMENT OF
SPS AND ALTERNATIVE ENERGY TECHNOLOGIES
David Kellermeyer
HDR Ecosciences
Santa Barbara, CA 93101

The potential effects of five energy technologies on global, regional, and local climate were assessed. The energy technologies examined were coal combustion, light water nuclear reactors, satellite power systems, terrestrial photovoltaics, and fusion. The assessment focused on waste heat rejection, production of particulate aerosols, and emissions of carbon dioxide. The current state of climate modeling and long-range climate prediction introduces considerable uncertainty into the assessment, but it may be concluded that waste heat will not produce detectable changes in global climate until world energy use increases 100-fold, although minor effects on local weather may occur now; that primary particulate emissions from coal combustion constitute a small percentage of total atmospheric particulates; that carbon dioxide from coal combustion in the U.S. alone accounts for about 30% of the current increase in global atmospheric CO₂, which may, by about 2050, increase world temperature 2-3°C, with pronounced effects on world climate; that rocket exhaust from numerous launches during construction of an SPS may affect the upper atmosphere with uncertain consequences; and that much research in climatology is needed before potential effects can be quantitatively predicted with any confidence. Although climatic impact is an appropriate concern in formulating long-term energy policy, the level of uncertainty about it suggests that it is not currently useful as a decision criterion.

[Extended Abstract Not Received]

RESEARCH ON THE USE OF SOLAR ENERGY IN THE DEPARTMENT OF ENGINEERING
THERMOPHYSICS, CHINA UNIVERSITY OF SCIENCE AND TECHNOLOGY
Kuan Liang Guo, Exchange Visiting Scientist
University of Alabama in Huntsville - China University of Science & Technology
Xin Shi Ge
China University of Science and Technology

In the recent years, research on some topics in the field of the utilization of solar energy which relates to the thermophysics is being made in the Department of Engineering Thermophysics of the China University of Science and Technology, a university established by the Academy of Science of China.

The consideration of satellites for power is only in the preliminary stage in China but may be expanded in the future. My paper will describe the current research in utilizing solar energy, so that participants may better understand the present technology in China and how it may be affected by a Satellite Power System. Also, an objective is to exchange views as to how the proposed solar power satellite system and related technology may affect China.

Current research includes solar water heaters, timber kilns, focusing collectors, low cost solar radiation measuring instruments and many others.

1. Research on the operation fashion of the solar water heater system. (1)

In China, there are more and more flat plate solar water heater systems coming into use. So far in Beijing, the total area of collectors amounts to 70,000 m². Most of them are installed on the roofs of buildings operating in thermosiphon mode and supplying hot water for domestic use (bathrooms). A main shortcoming of this kind of water heater is that the water storage tank has to be fixed above the collector, causing the increase of heat loss of the storage tank and of the weight load on the roof and enabling hot water to be obtained only in the afternoon. So, we have proposed a "One-Pass" solar water heater system which water will pass the collector by a small water tank above the collector. The storage tank of the "One-Pass" system thus can be placed indoors, and the heat loss will be reduced. Moreover, by this system hot water can be obtained earlier than by the "Thermosiphon" system. A preliminary calculation shows that the daily efficiency of the "One-Pass" system is almost the same as that of the "Thermosiphon" system. We believe that the "One-Pass" system is easier to adopt and popularize in China. To justify the theoretical analysis, the experimental study is being carried on now.

2. Design of solar timber seasoning kiln. (2)

Using solar energy to dry timber is being actively investigated in the U.S.A., Canada and Australia. In China, in the small furniture factories, there is no normal timber seasoning kiln. We have designed an experimental solar seasoning kiln for a small furniture factory which is located in the neighborhood of our university. The solar system designed is an air-based concept. Solar collectors are in two banks. Each bank has a nominal area of 30 m². The solar air heater consists of two glass covers and a ten-layer porous matrix absorber. The hot air from the collector is directed by a blower to the kiln and a pebble bed storage. The kiln designed has a capacity to dry timber of 4.5 m³, and the period of the drying process is about four days. The solar timber seasoning kiln has already been installed, and the performance experiment is being carried on.

3. Thermodynamic analysis of the vapour-pressurizing solar pump.⁽³⁾

The use of solar energy for the operation of irrigation pump is attractive in China. We have carried out the thermodynamic analysis of the vapour-pressurizing solar pump which has been studied by investigators in India, the Soviet Union and other countries. Vapour-pressurizing solar pump is driven by the vapour of working substances. Only the flow work of the vapour is utilized. So, the construction of the pump is rather simple because it does not have a rotating part. Thermodynamic analysis and calculation show that when the temperature of a heat source is lower, the cycle efficiency of the vapour-pressurizing pump is close to that of the Carnot cycle. Therefore, it is worthwhile performing research of the vapour-pressurizing pump in a small capacity. A comparison among five kinds of working substances shows that the F11 and F13 are more suitable for the vapour-pressurizing pump.

4. An analysis of steady state heat transfer for a conical focusing solar energy collector⁽⁴⁾

A detailed analysis of steady state heat transfer is made for a conical focusing solar energy collector with a cylindrical glass cover around the absorber. The equilibrium temperatures under various conditions have been calculated using a computer. The influences of the diameter of the absorber, the wind speed, and the emissivity of the absorber surface on the equilibrium surface have been discussed. The calculation shows that using the selective coating and the cylindrical glass cover both are effective means to improve the thermal performance of the collector. The cylindrical glass cover can also make the collector steadier. A solar autoclave designed on the basis of this analysis has been made. The thermal performance obtained from experiment has proved that our theoretical analysis is correct.

5. Prediction of the thermal performance of the natural circulation water heater.⁽⁵⁾

With the increasing interest in using solar water heaters, it is important for the design engineers to present a method which can predict the thermal performance of the solar water heater to be designed. In China, the more widely used solar water heaters are those operating by natural circulation, so the mathematical modeling and simulation methods are used to show the influences of the factors on the thermal performance of such water heaters. The factors we have studied are: the distance between the collector and storage tank, the wind speed, the insulations, etc. The results of calculation are in fair agreement with those obtained by the experiment. Thus, it is believed that the modeling and simulation method is suitable for designing solar water heaters.

6. Investigation on the low-cost solar radiation measuring instruments.⁽⁶⁾

In research on the use of solar energy and solar radiation resources accurate insulation measurements are essential. A new technique for measuring the intensity of direct solar radiation at normal incidence and solar radiation from the whole hemisphere is being developed. The pyrheliometer and the pyranometer constructed by using the suggested technique will be inexpensive in comparison with the commonly used instruments produced now in China. Unlike the usual method of measuring solar radiation, the new technique consists of measur-

ing the heating and cooling rate of the receiving surface of the instruments with and without radiation incidence respectively. A comparison of data obtained through our preliminary experiment with those of the local meteorological stations shows that the difference is within 15%.

7. Study of the radiation heat transfer in a coverglass-absorber system.⁽⁷⁾

The problem of radiation heat transfer in a coverglass-absorber is of great importance in the use of solar energy and in the thermal design of building engineering. This study presents a method for calculating the solar energy absorbed by the absorber and transparent covers in the systems with absorber and multilayer covers. We have made an analysis of the determination of the radiation heat loss of the absorber in the system consisting of an absorber and such a cover as has a significant transmittance in the infrared spectrum. The obtained formula for the calculation of radiation heat loss is easy to use. The physical meaning of the formula is also obvious.

8. Research on the measurements of the thermal radiation properties of the metals and coatings. (8,9,10)

In cooperation with the Shanghai Institute of Ceramics Academia Sinica, we have studied the measurement of the thermal properties of the solids. Several apparatus are designed and constructed, among which are: an integrating sphere for measuring the directional-hemispherical spectral reflectance for various incidences, two simple apparatus for measuring the normal thermal emissivity of the metals and coatings, and an apparatus for measuring the hemispherical total emissivity. Now some new apparatus are going to be installed.

The following investigations are being carried on now:

- 1) The measurement of the thermophysical properties of the phase change materials.
- 2) A study of the transient behavior of the latent thermal storage.
- 3) A design of the low plastic solar collector.

References

1. Wang Yifang and Li Zhilan, "A Comparison Between the 'One-Pass' and 'Thermosiphon' Solar Water Heater System and the Calculation of Their Thermal Efficiencies," presented at the First National Conference on Application of Solar Energy, September 1979, Xian, China.
2. Zhang Keli, "Design of Solar Timber Seasoning Kiln," Ibid.
3. Wang Yifang and Ge Xin Shi, "Thermodynamic Analysis for the Vapour-Pressurizing Solar Pump and Selection of the Working Substances," Ibid.
4. Wang Yifang and Li Zhilan, "An Analysis of Steady State Heat Transfer for a Conical Focusing Solar Energy Collector," Ibid.
5. Lu Weide, Sun Xiaolan, and Guo Huifen, "Design Study of the Natural Circulation Solar Water Heater System," Ibid.
6. Cheng Shuxia and Ge Xin Shi, "Preliminary Research in the Measurement of the Solar Radiation by a Transient Method," Ibid.
7. Ge Xin Shi and Sun Xiaolan, "Radiation Heat Transfer in a Coverglass-Absorber System," to be published.
8. Ge Xin Shi, Cheng Suxia, et al., "On the Measuring and Checking of the Normal Thermal Emissivity of the Metals and Coatings," presented at the First National Conference on Applications of Solar Energy, September 1979, Xian, China.
9. Ge Xin Shi and Peng Yun, et al., "Research in Measurement of Solar Absorbance," presented at the Second National Conference on Engineering Thermophysics, October 1978, Hangzhou, China.
10. Cheng Shuxia, "An Investigation of the Methods for Measuring Hemispherical Total Emittance," Ibid.

SATELLITE POWER SYSTEM COST REVIEW
R. E. Allen - P. E. Brown - E. J. Ziegler
United Engineers and Constructors, Inc.

The probable implementation cost of the SPS technology is an important element of information necessary to make a rational decision regarding future research and/or development. Although projected costs are estimated as part of the systems definition activity, better definition and resolution can be obtained through an independent engineering evaluation or "audit" of some major cost components in current SPS design concepts. Thus, selected system definition assumptions and cost estimating relationships for each of the three SPS concept designs were independently reviewed. The review focused on definition and cost compatibility with current research, development, engineering and construction practices. The systems within the SPS designs chosen for review are several of the major cost elements and include:

1. Rectenna construction,
2. Graphite fiber reinforced thermoplastic structures,
3. Solar cells,
4. Satellite electrical slip rings,
5. Satellite electrical systems, and
6. Ground rectenna electrical systems.

Where sufficient data or information was available in the SPS concept descriptions and correspondingly in the technical literature and/or current construction and manufacturing practices, multipliers were developed to quantify the possible range of cost above or below current estimates. Where cost multipliers could not be developed, potentially important cost impacts were identified and evaluated qualitatively.

ESTIMATED RANGE OF COST MULTIPLIERS

Estimated cost multipliers for the systems and cost estimating relationships reviewed are shown in Table 1. The table values are multipliers to the current estimated costs of the indicated system components. In most cases it is not possible to estimate the variation in dollar costs associated with the multipliers. Two factors contribute to this dilemma. First, not all of the components making up each of the six systems were reviewed; programmatic limitations enabled only selected components for each system to be reviewed. Second, although descriptive information is generally available for the individual system components, these are not defined to the point of specification because additional research and development is needed to demonstrate the functional capability required. Thus, it is generally not possible to estimate the cost variations associated with the components that were reviewed.

These multipliers may increase or decrease as additional research, development, and engineering are completed for the various systems.

- The rectenna construction includes the basic civil engineering activities (i.e., site clearing and leveling, footing excavation, concrete installation, support and logistical activities).
- The graphite reinforced thermoplastic structures include a discussion of the wide variety of graphite fiber materials, problems associated with obtaining desired characteristics and questions regarding the intercompatibility of the fibers and the thermoplastic. Excluded from these cost assessments is any discussion of the production methods for the basic materials or for the

structures made from them.

- The solar cell cost review includes basic materials, refined materials, solar cell assembly and interconnection. Excluded is any discussion of the aggregation of cells into solar panels/blankets.
- The slip rings cost review includes the materials and the potential environmental problems of assembly and long term behavior. Excluded is any discussion of mechanical assembly or the electrical capability of the slip ring design.
- The satellite and ground electrical systems cost review concludes that insufficient technical specifications are available to permit cost comparison with existing analogous electrical systems and components.

The estimated cost multipliers are summarized in Table 1.

CONCLUSIONS

This review of estimated costs for the SPS has led to a number of conclusions. These conclusions are preliminary to the degree that they are based on consideration of preliminary data:

- Conceptual designs of systems and equipments,
- Projections of current research and development efforts to future levels of performance and production,
- Uncertainties in specific functional requirements,
- Areas where existing technology currently provides no obvious solutions.

Moreover, the conclusions are limited primarily to the six systems/equipments/components previously discussed. Although the items selected for review constitute somewhat greater than 50 percent of the capital costs as estimated in the studies reviewed, there are major areas of technology and costs which were not appraised in this present evaluation. Among these major areas are:

- Space construction,
- Earth - LEO - LEO - GEO transport vehicles, support, and operations,
- In-orbit, GEO, operation and maintenance and spares,
- Operation and maintenance costs for the rectenna.

In the absence of a critical appraisal of these areas, the cost multipliers in Table 1 should be used only as a numerical guide to determine where further R&D and engineering should be expended.

Two general conclusions appear warranted by the reviews presented here.

1. The costs projected are based on optimistic assessments of future technological and manufacturing capabilities when compared with cost generated on the basis of the current status of research and development, engineering demonstration, and production practices.

2. All systems/equipments/components require substantial further definition to provide the engineering specifications required for cost projections. In many instances, current technology does not allow for dramatic cost reductions and does not guarantee the anticipated step-function improvements -- technology breakthroughs -- needed to reach the desired goals.

The specific conclusions pertaining to the six areas assessed may be summarized as follows:

1. Costs for the rectenna construction (explicitly excluding the receiving diodes and rectifiers (which were not reviewed in this study) and the electrical distribution and conversion system noted in Conclusion 5 do not represent current construction technology, methods and site management. The optimisms characterizing the costs are not supported by current construction experience and overall are low by a factor of three to five times.
2. The GF RTP structures proposed are not defined sufficiently to identify the retired graphite fiber constituents and the methods of fabrication. Current costs for graphite fibers range from relatively modest \$25/lb to very high -- \$1,000/lb. Structural cost uncertainties are consequently high and the potential cost range very large.
3. Costs for GaAs photovoltaics are extremely optimistic measured against existing technology. Breakthroughs are assumed to occur to achieve the conceptual design goals for weight, performance, and costs.
4. Costs estimated for Si photovoltaic systems are less optimistic than those projected for GaAs, but still require cost reductions of 20 times to meet the DOE goals for 1986, performance improvements of 40 percent, and production capability increases of 100 times, to achieve the SPS objectives. The costs using the DOE goal of \$0.50/Wp gives SPS solar cell costs three times higher than those estimated.
5. Current definition status of the slip ring design and number required does not permit a confident appraisal of materials, construction methods and operational capability.
6. Review of the satellite electrical system is limited to identification of necessary design features which may significantly alter the cost relationships estimated in the system definition and reference design studies. Insufficient detail is given in the studies reported to make a direct determination of the credibility of costs presented or whether all needed items are costed and included.

TABLE 1

ESTIMATED RANGE OF COST MULTIPLIERS

	<u>Rockwell/MSFC</u>	<u>Boeing/JSC</u>	<u>Reference</u>
Rectenna Construction	2x	3x	3x
Graphite Reinforced Structures	(a)	(a)	100x
Solar Cells	30x	3x	(c)
Slip Rings	20x	10x	10x
Electrical Systems - Satellite	(b)	(b)	(b)
Electrical System - Ground	(b)	(b)	(b)

(a) See sections 1.3.2 and 3.2 for details, Satellite Power System Cost Review Study.

(b) Insufficient technical and cost detail is currently available to develop this information. A wide range of uncertainty is identified, relative to comparison of overall SPS electrical estimates with current electric plant costs, given the orders of magnitude of quantities of SPS components.

(c) Not applicable.

CRITICAL REVIEW OF SATELLITE POWER SYSTEMS (SPS) SPACE TRANSPORTATION
COST ESTIMATES

R. W. Earhart, C. W. Hamilton, K. Maher, R. R. Teeter
Battelle Columbus Laboratories, 505 King Avenue, Columbus, Ohio 43201

Satellite power systems must be economically competitive with alternative terrestrial methods to achieve broad success. As part of a comparative assessment of power generation costs in the SPS time frame, investigations of the SPS cost estimates have been undertaken. The results reported here cover the SPS space transportation requirements and costs for the current Reference Design.

(1) The vehicle design and theoretical first unit costs estimated by the contractors are reasonable. The learning assumptions made are also reasonable, but the use of the average unit costs for the initial vehicles is questioned. The chemical propulsion vehicles have uncertainties, inherent in the methodology of cost estimating relationships, of ten to twenty percent in the stated costs. This low uncertainty is predicated upon successful completion of the Space Shuttle and an active NASA space program pursuing vehicle technology.

(2) The SPS program costs for transportation are based on an ambitious scenario which assumes 100 percent reliability for the vehicles. An increase in recurring transportation costs of about ten percent, to allow for additional vehicles and related efforts to insure the ability to maintain the proposed SPS platform construction rate of two per year is recommended. The exact level of the reserve vehicles depends upon determining acceptable program risks. Until this is accomplished, a reserve of 10 percent, in analogy to airlines, should be used.

(3) The special development of the Personnel Launch Vehicle (PLV) Booster for use in the SPS is questioned. The use of a personnel module aboard the Heavy Lift Launch Vehicle (HLLV), if acceptable for safety, would avoid the booster development expense and have a lower recurring cost than the PLV. The appropriate use of the Shuttle or its derivatives is, however, still an open question.

(4) The Electric Orbit Transfer Vehicle (EOTV) has the highest cost uncertainty of the vehicles in the Reference System because experience in the technologies needed, especially space structures, is not as advanced as experience in other vehicle technologies. The large size of the EOTV indicates a potential problem of a significant collision rate and the need of structural and other redundancies to permit survival with only slightly degraded capabilities. Achieving the EOTV cost estimates is predicated both on demonstrating successfully the vehicle technology through applications such as a Solar Electric Propulsion Stage and also on the successful development of the SPS platform design itself. The EOTV is viewed as a section of the SPS platform with the power directed to ion engines rather than a microwave antenna. The uncertainty of the EOTV cost can therefore only be rated as "very high" for which the value -15 percent to +100 percent is assigned to compute the potential quantitative impact on overall transportation costs.

Detailed findings are summarized in the Table.

SPS TRANSPORTATION COST ESTIMATES, ADJUSTMENTS AND UNCERTAINTIES

(\$, Millions, 1977)

Vehicle	JSC Cost Estimate(1)	Battelle Uncertainty	Battelle Recommendation	Battelle Uncertainty
<u>HLLV</u>				
DDT & E Initial Invest.	11,202(2) 6,893 (6 Vehicles)	+15% -15%; +50%	Same 9,303(3) (7 Vehicle)	Same +15%
Avg. Per Flight	10.1	+15%	Same	Same
Avg. Per SPS	1,954	-15%; +25%	2,150(4)	+15%
<u>EOTV</u>				
DDT & E Initial Invest.	2,247 8,649 (23 Vehicles)	Very High (100%) -15%; +100%	Same 10,000(5) (28 Vehicles)	+15%; +100% Same
Avg. Per Flight	40.7	-15%; +100%	44.7(6)	Same
Avg. Per SPS	575	-15%; +100%	633(6)	Same
<u>PLV</u>				
DDT & E Initial Invest.	2,616(7) 1,463(9)	+15% +15%	~100(8) 1,100(10)	Plans Required Same
Per Flight	10.7	+15%	2.2(11)	Same
Per SPS	260	+15%	54(11)	Same
<u>POTV</u>				
DDT & E Initial Invest.	1,012 144 (2 Vehicles)	+15% -15%; 30%	Same 373(12) (5 Vehicles)	Same +15%
Per Flight	1.3	+15%	13.5(13)	Same
Per SPS	12.7	+15%	13.1/132(14)	Same

SPS TRANSPORTATION COST ESTIMATES, ADJUSTMENTS AND UNCERTAINTIES (CONTINUED)

(\$, Millions, 1977)				
Vehicle	JSC Cost Estimate ⁽¹⁾	Battelle Uncertainty	Battelle Recommendation	Battelle Uncertainty
<u>IOTV</u>				
	Not in Space Transport Estimates		Transport Impacts of Space Ops. Needed for Full Picture	
Ground Support				
<u>Per Year</u>	513 ⁽¹⁵⁾	High	Same	Same
<u>Per SPS</u>	263	(+25%)	Same	Same
<u>SPS Transport</u>				
DDT & E	17,077	-15%; +25%	Same	Same ⁽¹⁶⁾
Initial Invest.	17,149	-15%; +70%	20,776 ⁽¹⁷⁾	Same ⁽¹⁶⁾
Per SPS	2,802	-15%; +35%	3,113 ⁽¹⁸⁾	Same ⁽¹⁶⁾

- (1) SPS Transportation System Cost Estimates, Johnson Space Center, November 14, 1979.
- (2) Excludes Research; strong tech. pgm assumed.
- (3) Addition of one reserve HLLV and strict application of 85 percent learning curve.
- (4) 10 percent payload reserve for growth in SPS and Miscellaneous requirements.
- (5) Addition of five reserve vehicles; mature industry assumption. 70 percent learning applied to TFU results in \$19 billion.
- (6) 10 percent cost reserve for orbital maintenance facilities allocated to vehicles.
- (7) PLV booster co-developed with HLLV.
- (8) Battelle estimate for HLLV personnel module.
- (9) Purchase of 2 PLVs without personnel module.

- (10) Purchase of 1 HLLV in addition to reserve vehicle.
- (11) 22 percent of HLLV cost per flight.
- (12) Purchase of 5 POTVs with strict application of 85 percent learning curve.
- (13) Adjustment reflects direct charge of 1 HLLV flight plus 5 percent of EOTV flight costs to haul propellant plus \$50K in downtrip propellants to POTV. Personnel Module costs excluded.
- (14) JSC Transportation Cost Estimates correctly account for POTV costs in overall transport scenario.
- (15) 6425 man-years at KSC at \$40 per hour.
- (16) Dollar weighted average of uncertainties.
- (17) Includes reserve vehicles and uses mature industry assumption for EOTV.
- (18) Includes Ground Support at KSC.

UTILITIES VIEW OF SPS
J. Patmore and J. Bohn
Systems Control, Inc. - Palo Alto, California

BACKGROUND: The U. S. Department of Energy (DOE) and National Aeronautics and Space Administration (NASA) are currently conducting an evaluation of a solar satellite power system (SPS). The SPS would convert solar energy to microwaves and beam the energy to collecting antennas on the ground for conversion to electricity. The overall system, envisioned as being initiated about 2000 and completed about 2030, would consist of 60 geosynchronous satellites each delivering 5 GW of power to conventional utility networks. The cost of the overall system is estimated to be between 0.6 and 1.2 trillion dollars.* To date, about \$20 million have been spent analyzing and refining the designs of major subsystems. A limited effort has been expended on studying the SPS/utility interface. This note summarizes the results of a study commissioned by the Electric Power Research Institute, of the problems to be encountered in utility integration of a single 5 GW SPS.

This study had two primary objectives:

- to identify for the electric utility industry those characteristics of the SPS that will be most significant in implementing the interface with a conventional utility power system.
- to indicate to the SPS community the technical and economic concerns of the electric utility industry regarding the development of the SPS concept.

SPS could be an important means of tapping solar energy, however, there are many technical, economic, social, and political problems that must be solved before the SPS could be built. If the SPS is implemented, its unique features will pose unique problems for the conventional utility network into which it feeds its power.

ECLIPSE AND LOAD FOLLOWING: The spring and fall eclipse periods which the SPS undergoes create some unique problems for the utility system. The onset and retreat of the eclipse periods is very rapid — it takes the SPS a few minutes (2-4) to go from full sunlight to full shadow and the same to emerge. But it takes additional time to shut down and restart the SPS — about 5 minutes to shut the SPS down and 16 to 60 minutes to restart, depending on the length of the down period. However, the load following capability of the utility system may well impose a more serious constraint. The maximum response capability of conventional units range from 1-5%/minute, whereas the SPS can be shut down at the rate of 20%/minute and restarted at the rate of 2-7%/minute. Thus, it is likely that the capability of conventional units will be the limiting factor, not the SPS system. A large number of gas turbines designed for fast start-up may be desirable or even required in a system utilizing the SPS. One negative impact of SPS eclipses would be the increased cycling duty of conventional units which would cause increased O&M costs and forced outage rate for these units.

*All costs cited in the text are in constant 1977 dollars.

The reference system design provides no mechanism for frequency or power level regulation by means of the SPS; it is assumed that the SPS will normally be operated at its maximum available power. As a consequence, the regulation burden will have to be carried by the conventional units in the system. This may be a limiting factor on SPS penetration.

RELIABILITY: The use of an SPS in a utility system might either increase or decrease the reserve margin required to maintain a given reliability standard, depending on how reliable the SPS is. A much more careful and complete failure analysis of the SPS must be conducted before a confident determination of its effect on reserve margin can be made. Modes leading to complete or substantial loss of the SPS output are particularly important since they will have the greatest impact on reliability. Should it prove to have high reliability compared to conventional units, the SPS will impose a correspondingly high reliability requirement on its associated transmission network. This presumably will be accomplished by a greater than usual degree of transmission line redundancy.

MAINTENANCE: Maintenance will surely be one of the major problems of the SPS. For example, there are about seven billion diodes in a rectenna and their mean time to failure is estimated to be 30 years. Assuming an exponential failure law, the expected number of failures per year is approximately 200,000. This would lead to a corresponding degradation in performance of about 3%/year unless failed diodes are regularly replaced. Locating and replacing 200,000 diodes per year would appear to be a Herculean task.

RISK: There are several kinds of risk associated with SPS. A very significant risk involves the opportunity cost of the SPS. If financial and other resources are committed to the SPS, then some other opportunities must be foregone since resources are limited. Since the resources needed to develop the SPS are quite substantial, the associated risk may be significant, and should be carefully evaluated. A utility (or utilities) expecting to incorporate the SPS into its system must plan and start constructing the appropriate transmission lines and complementary generation plants several years in advance of the anticipated SPS completion date. If, for any reason, the SPS cannot be completed on time, does not operate as designed, or is cancelled, then the utility will not only face a substantial economic loss, but will also find it difficult to make up for the lost capacity. Thus, utilities will be wary of SPS until it has been demonstrated to be constructable on schedule and reliable in operation.

ALTERNATIVE ADVANCED POWER GENERATION TECHNOLOGY CHARACTERIZATIONS

M. E. Samsa

Argonne National Laboratory - Argonne, Illinois 60439

The role of the Satellite Power System (SPS) as a means of producing electrical energy early in the twenty-first century will depend, to a major extent, on how well it compares with other available alternatives during that time period. The basis for comparison will include all aspects of electrical power production such as fuel and non-fuel resource use, conversion of efficiency, environmental residuals, construction and operational labor requirements, costs, and other effects such as socioeconomic and macroeconomic impacts. The starting point for the comparative assessment of these and other issues is the description of the SPS Reference Design Concept and corresponding descriptions of a range of alternative terrestrial technologies for electric power production in the post-2000 time period. NASA and NASA contractors have defined the SPS reference design concept, and thus the purpose of the alternative technology characterizations is to provide a detailed and consistent description of terrestrial alternatives for electric power generation in the time period of interest.

Seven alternative technologies that have been selected for comparison with the SPS and whose major characteristics are displayed in Tables 1 and 2 include the following:

Improved Conventional Technologies

- Conventional Coal Combustion with Wellman-Lord Flue Gas Desulfurization
- Light Water Reactor with Improved Fuel Utilization

Near-Term Technologies

- Gas Turbine Combined Cycle with Integral Low Btu Gasifier
- Liquid Metal Fast Breeder Reactor

Advanced Technologies

- Central Station Photovoltaic without Storage
- Residential Rooftop Photovoltaic with Advanced Lead-Acid Battery Storage
- Magnetic Confinement Fusion

An important consideration was to assure consistency in terms of the level of technological development assumed to occur between now and the year 2000, and in terms of the fuel characteristics and cost estimating relationships used in the characterization of these systems. A high level of consistency is necessary to provide standardized technological benchmarks for further analysis and comparison with the SPS reference system.

The general approach was to review a broad segment of the recent technical literature concerned with the characteristics of the individual technologies and their accompanying fuel cycles. This data base of information was then synthesized into the alternative technology reference characterizations by adapting the data into internally consistent energy and materials balances for each of the systems. Where appropriate, a nominal generating capacity of 1250 MWe was selected for the reference technologies. Only the central

station photovoltaic, residential rooftop photovoltaic, and magnetic confinement fusion systems differ from this nominal capacity due to special considerations unique to each system.

An integral part of the energy and materials balances was the determination of natural resource requirements such as land, water, fuels, and other raw materials, and the determination of environmental residuals including air emissions, liquid effluents, solid and radioactive wastes. These parameters have been estimated for the main plant site and for major elements of the respective fuel cycles.

The final step in the characterization procedure was to estimate the capital construction costs, labor requirements, and annual non-fuel operation and maintenance (O&M) costs for each alternative reference system. Detailed equipment, materials and site labor requirement lists from the Energy Economic Data Base (EEDB) and other major references were used as the basis for estimating the direct and indirect capital construction costs and construction labor requirements for many of the systems. For technologies not included in the EEDB, similar data from other major references was used. All costs are presented in 1978 dollars.

Direct capital costs include the costs of all materials, components, structures and direct labor necessary to construction of the reference facility at the plant site. Indirect costs include site temporary construction facilities, payroll insurance and taxes, and other construction services. Excluded are items sensitive to the particular policies of individual utilities including owner's costs, fees and permits, interest on construction funds, and price escalation during construction and contingency funds.

Non-fuel O&M costs were derived based on labor requirements, disposal and materials handling costs, and other factors applicable to the respective technologies. Non-fuel O&M costs for each system except the residential rooftop photovoltaic system include a sinking fund accrual of thirty percent of the plant's total direct and indirect capital costs over the lifetime of the facility for interim replacements. Decommissioning costs for each of the nuclear systems are also included.

Fuel costs for each of the systems are scenario-dependent and will be estimated as part of the subsequent cost and performance analysis.

Table 1 Major Characteristics of Alternative Central Station Technologies

Technology	Conventional Coal w/Advanced FGD	Light Water Reactor w/Improved Fuel Use	Coal Gasification Combined Cycle	Liquid Metal Fast Breeder Reactor	Central Station Photovoltaic	Magnetic Confinement Fusion
Major Feature	Wellman-Lord SO ₂ Removal	Fuel Burnup 50 MWd/KgU	32 Fixed Bed Gasifiers	Uranium/Thorium Fuel Cycle	SPS Photovoltaic Cell Efficiency	NUWAK Concept
Nominal Capacity (MWe)	1,250	1,250	2 @ 625	1,250	200	2 @ 660
Heat Rate (Btu/kWh)	9,546	10,224	8,865	9,330	NA	10,835
Conversion Efficiency(%)	35.8	33.4	38.5	36.6	14.2	31.5
Air Emissions						
Plant Site						
SO ₂ (T/yr)	21,200	-	11,090	-	-	-
NO _x (T/yr)	22,000	-	2,320	-	-	-
Particulates	250	-	200	-	-	-
Radionuclides (Ci/yr)	-	4,100	-	155	NA	730
Fuel Cycle						
SO ₂ (T/yr)	290	6,040 ^(a)	270	6	NA	-
NO _x (T/yr)	220	1,600 ^(a)	205	23	NA	-
Particulates (T/yr)	1,300	1,550	1,200	1	NA	-
Radionuclides (Ci/yr)	-	95	-	409,500	NA	-
Solids and Sludges						
Plant Site						
Dry Sulfur (T/yr)	95,565	-	91,725	-	NA	-
Ash Sludge (T/yr)	426,490	-	317,060	-	NA	-
Other (T/yr)	18,400	(b)	18,600	(b)	(c)	(b) ^(d)
Radionuclides (Ci/yr)	-	11,000	-	33,000	NA	9,000 ^(d)
Fuel Cycle Solids (T/yr)	113,600	215	105,650	1	NA	-
Liquid Effluents						
Plant Site						
Total Solids (T/yr)	16,000	1,330	16,000	1,330	-	(c)
Radionuclides (Ci/yr)	-	405	-	482	NA	(c)
Fuel Cycle						
Total Solids (T/yr)	5,220	-	4,850	-	NA	-
Radionuclides (Ci/yr)	-	1,500	-	(c)	NA	-
Water Use (10 ⁶ gal/day)	70	33	13	29	-	37
Land Use						
Plant Site (acres)	500	500	500	500	1,000	500
Fuel Cycle (acres/yr)	250	22	235	1	NA	-
Labor Requirements						
Plant Construction (10 ⁶ mh)	9.3	15.5	13.4	12.7	1.7	17.4
Plant Operation (persons)	259	215	336	225	26	(c)
Fuel Cycle (persons)	650	225	605	(c)	NA	-
Costs (1978 dollars)						
Direct (10 ⁶ \$)	452.1	486.0	537.4	702.9	117.5	1,533.2
Indirect (10 ⁶ \$)	90.7	197.1	132.7	262.6	20.0	628.6
Total (10 ⁶ \$)	542.8	683.1	670.1	965.5	137.5	2,161.8
Total (\$/kWh)	434.2	546.5	536.1	772.4	687.5	1,637.7
O&M Cost (mills/kWh)	3.1	2.2	2.7	2.9	3.4/4.6 ^(e)	7.3
Operating Factor (%)	70	70	70	70	25.8/19.1 ^(e)	70

NA - Not Applicable
 - - Small or Negligible
 (a) - 98% due to supporting power production
 (b) - quantified in terms of Ci/yr

(c) - not estimated
 (d) - After 10 yrs of on-site storage
 (e) - values for Phoenix/Cleveland

Table 2 Residential Roof-Top Photovoltaic System Characteristics

	Phoenix			Cleveland		
	Cases*			Cases*		
	1	2	3	1	2	3
Annual Demand (kWh)	7,220	12,330	20,650	7,220	12,330	25,030
Solar Photovoltaic System Output Used (kWh)	6,430	9,600	14,508	4,160	6,550	9,845
Demand Supplied by System (%)	89	78	70	58	53	39
Physical Characteristics						
Array Area (ft ²)	480	720	1,080	480	800	1,130
Inverter: Capacity (KVA)	6	8	10	6	8	10
Size (ft ³)	10.3	13.6	7.0	10.3	13.6	7.0
Weight (lbs)	289	328	368	289	328	368
Battery: Capacity (kWh)	20	30	30	20	30	40
Size (ft ³)	6.4	9.5	9.5	6.4	9.5	13.0
Weight (lbs)	816	1,226	1,226	816	1,226	1,634
Costs (1978 dollars)						
Array (FOB)	1,924	2,886	4,328	1,924	3,207	4,531
Field Materials (FOB)	5,118	6,028	6,291	5,118	6,015	6,912
Installation	699	796	942	699	828	963
Wholesale Margin, Transport and Taxes	1,171	1,460	1,694	1,171	1,500	1,934
Contractor Overhead and Profits	<u>1,278</u>	<u>1,610</u>	<u>1,940</u>	<u>1,278</u>	<u>1,675</u>	<u>2,095</u>
Total	10,190	12,780	15,195	10,190	13,225	16,435
Annual O & M Cost	327	436	572	327	465	608

* Case 1 - Normal 115 volt circuitry, stove/range and clothes dryer
 Case 2 - Case 1 plus domestic hot water heater
 Case 3 - Case 2 plus space heating and cooling with heat pump.

ALTERNATIVE FUTURE ENERGY PRICE/DEMAND SCENARIOS
R. U. Ayres
Carnegie-Mellon University

One of the notable characteristics of SPS is its enormous intrinsic scale, dictated by the massive pre-requisite research and space-hardware development commitment. Large costs must be borne before any benefits appear, and the pay-out period is inherently long. Thus, a 50-year period (1980-2030) has been selected for analysis purposes. Over a period of half a century many socio-economic relationships that can be safely regarded as "quasi-static" from a short-range standpoint must be regarded as inherently dynamic. Hence, long-range forecasting is an especially difficult and demanding art.

Among the factors that may change significantly over such a long period are population and productivity growth, demand or utility preferences, interindustry relationships (I-O coefficients) --reflecting technological change-- and factor prices. With regard to most of these long-range travels --which do not vary independently-- we have elected to borrow heavily from a comprehensive 5-year effort recently completed by Ridker and Watson at Resources for the Future, Inc. The bulk of the effort that was undertaken specifically for the SPS evaluation has therefore been focussed on factor prices --particularly primary energy fuels (coal, gas, petroleum and uranium) and electricity.

The factors that will control future energy prices in a market environment are as follows:

- The level of economic activity (GNP)
- The intrinsic "energy-intensity" of the economy (i.e. the elasticity of substitution)
- The physical and other constraints on future supply from existing sources including regulatory limitations.
- The costs of obtaining future supplies from alternative sources, including tar sands, oil shale, coal liquids or syngas and various decentralized technologies such as windmills small-scale hydropower, passive solar collectors, biomass, etc.

Obviously the future growth of the GNP is, itself, affected by energy prices. A complete general equilibrium analysis at the required level of detail would be impracticable. Hence, we carry out the analysis for a single "target" GNP growth rate --somewhat below historical levels-- that appears to be an upper limit of the range of plausible possibilities due to constraints on capital availability. It is understood that actual energy demands (hence prices) are likely to fall below this upper limit.

The intrinsic energy-intensity of the economy --or, equivalently, the elasticity of substitution of capital for energy-- is not known with high confidence. Therefore, we have taken this as one of several scenario parameters, and we have constructed scenarios assuming three different values of the elasticity. The central or "intermediate" case is the most likely. Similarly, the rightness of future supply constraints is uncertain. To deal with this, we have postulated a schedule of maximum supply availabilities for each primary fuel, that might correspond to a "tight" set of constraints. Scenarios in which

these availabilities cannot be exceeded are called "Constrained". Scenarios in which the postulated schedule of future availabilities can be exceeded are called "Unconstrained".

We have also considered two cases as regards to the cost of alternative forms of energy. There now appears to be a reasonable consensus on the future cost of well-studied options such as shale oil and coal liquids or syngas. There is less agreement on the future cost of unconventional "decentralized" sources of energy such as windmills, passive solar, biomass, etc. Much depends on the rapidity of technological progress, the size of the market and the applicability of mass production techniques. To reflect these uncertainties, we included two additional constrained scenarios in which "decentralized" energy sources turn out to be much less costly than present day estimates. Supply-demand balances and energy prices are forecast for eight scenarios altogether. Of these, 6 scenarios are "centralized" cases. That is, they assume "high priced" solar energy (\$9/million Btu). They can be classified as follows:

	High E/GNP (H) Low Elasticity ($\eta = -0.25$)	Intermediate E/GNP (I) Intermediate Elasticity ($\eta = 0.7, -0.4$)	Low E/GNP (L) High Elasticity ($\eta = -0.75$)
Unconstrained (U)	UH	UI	UL
Constrained (C)	CH	CI	CL

The remaining two decentralized scenarios assume (low priced) solar energy (\$4.50/million Btu) as follows:

	High E/GNP (H) Low Elasticity ($\eta = -0.25$)	Intermediate E/GNP (I) Intermediate Elasticity ($\eta = -0.7, -0.4$)	
Constrained (C)	CH(d)	CI(d)	decentralized

So far nothing has been said about probabilities. At this point, it is appropriate to note that while no single scenario can necessarily be regarded as likely --there are far too many possibilities-- there are different degrees of unlikelihood. The least improbable scenario, as we see it, is the intermediate constrained (CI) case, followed roughly in order of probability by UI and CI(d). The other cases are primarily included to bound the range of reasonable possibility.

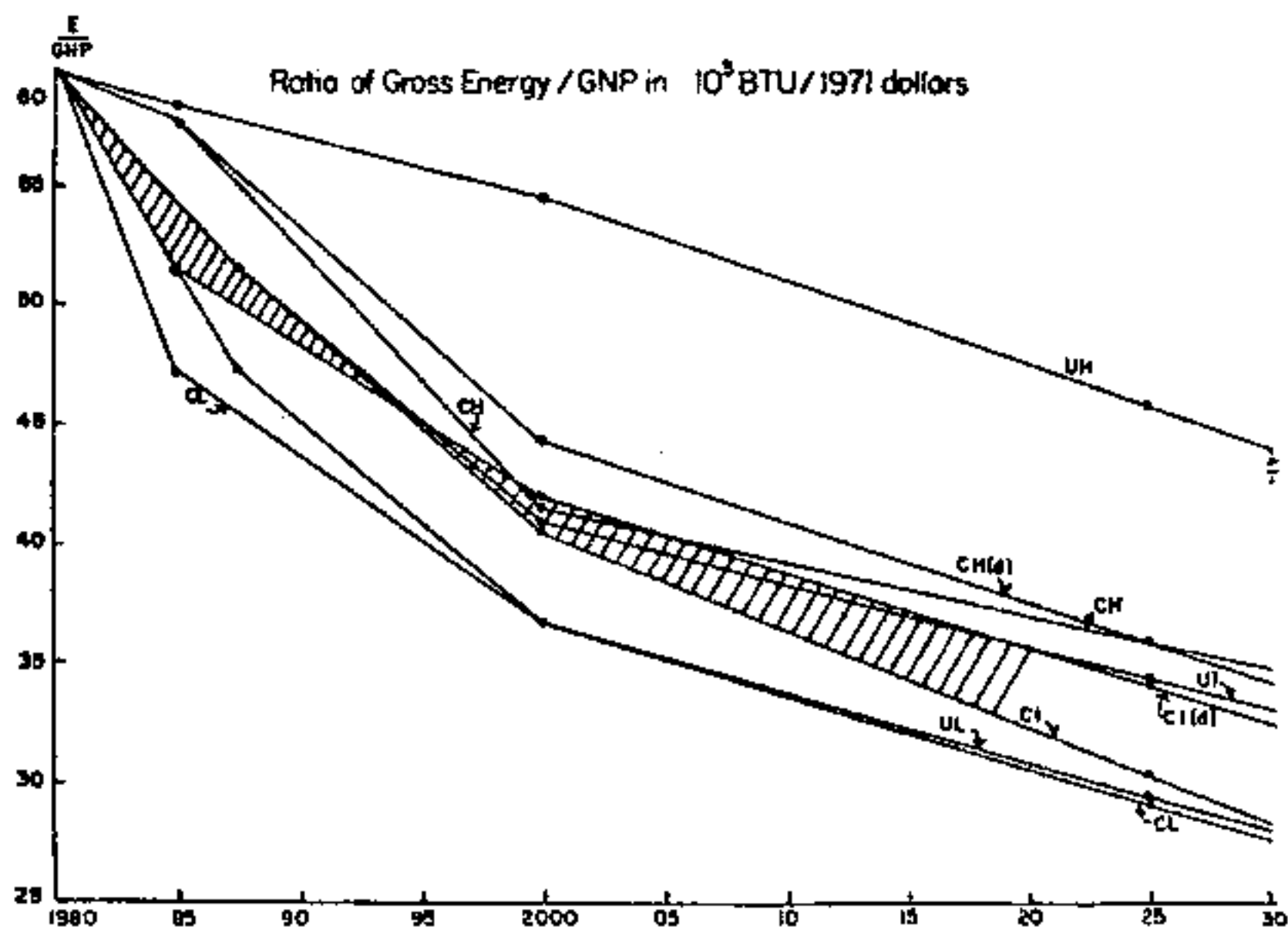

Supply-Demand Patterns for Various Scenarios in the Year 2000

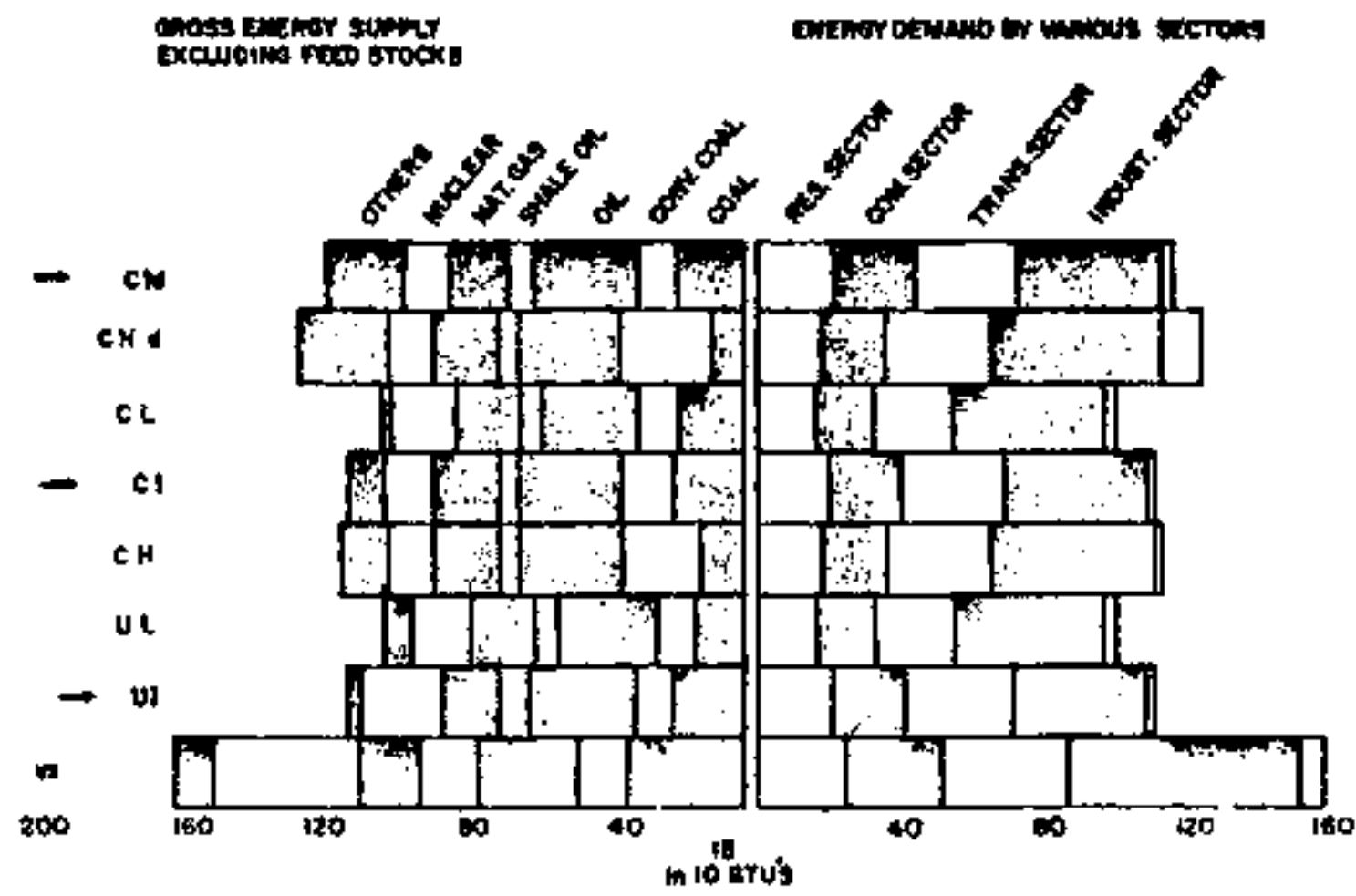

Supply-Demand Patterns for Various Scenarios in the year 2025

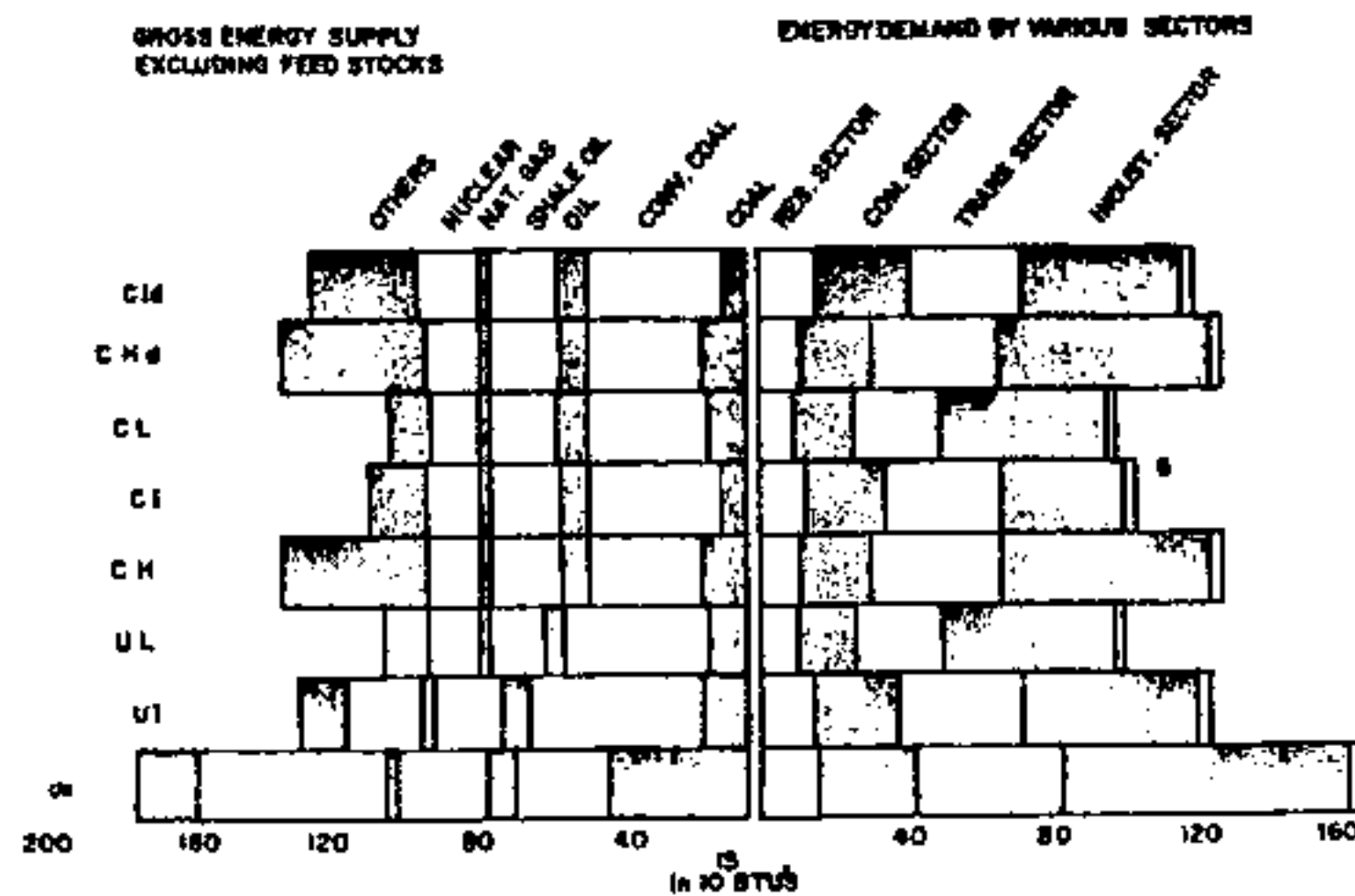

Delivered Oil Prices

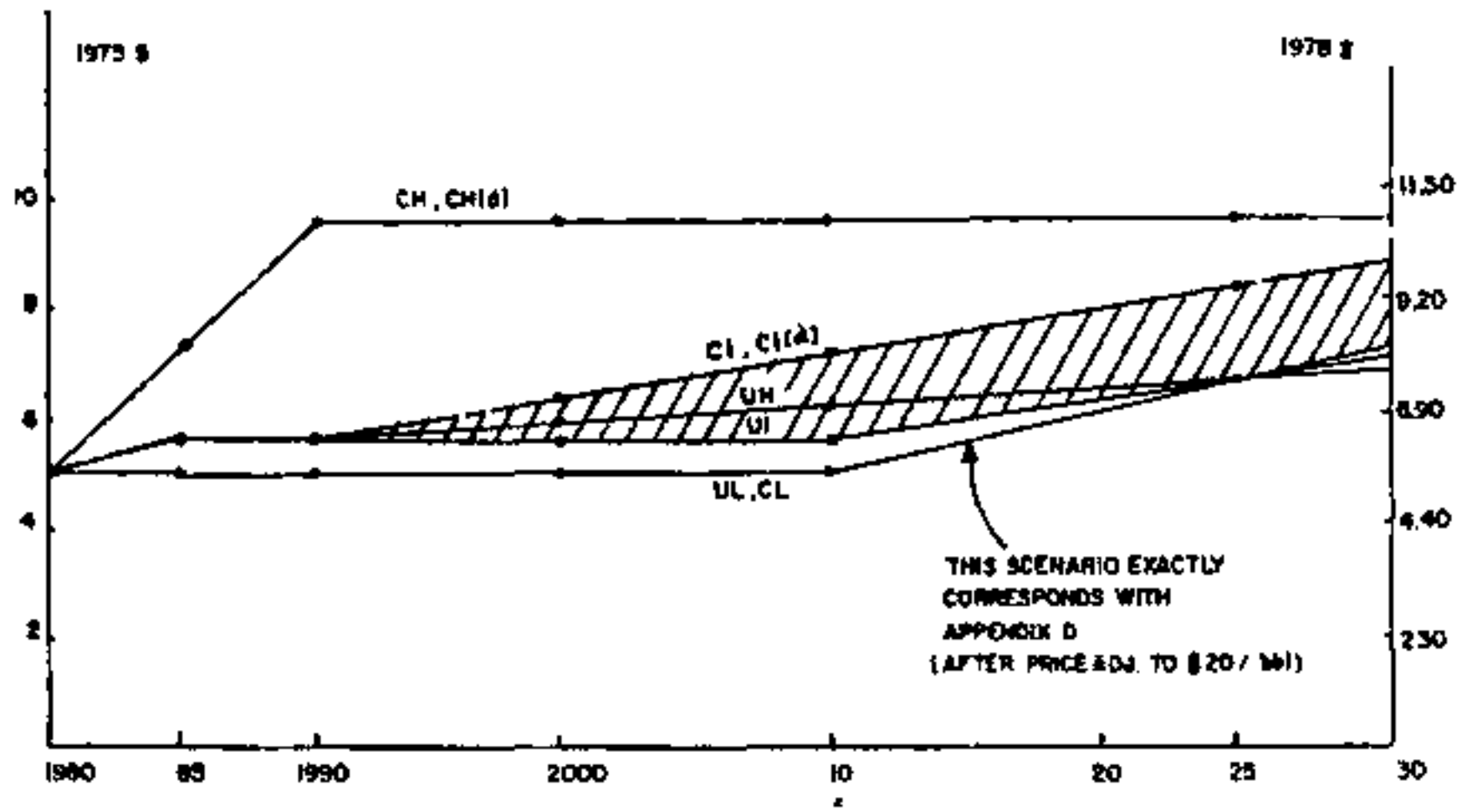

Delivered Natural Gas Prices, \$/million BTU

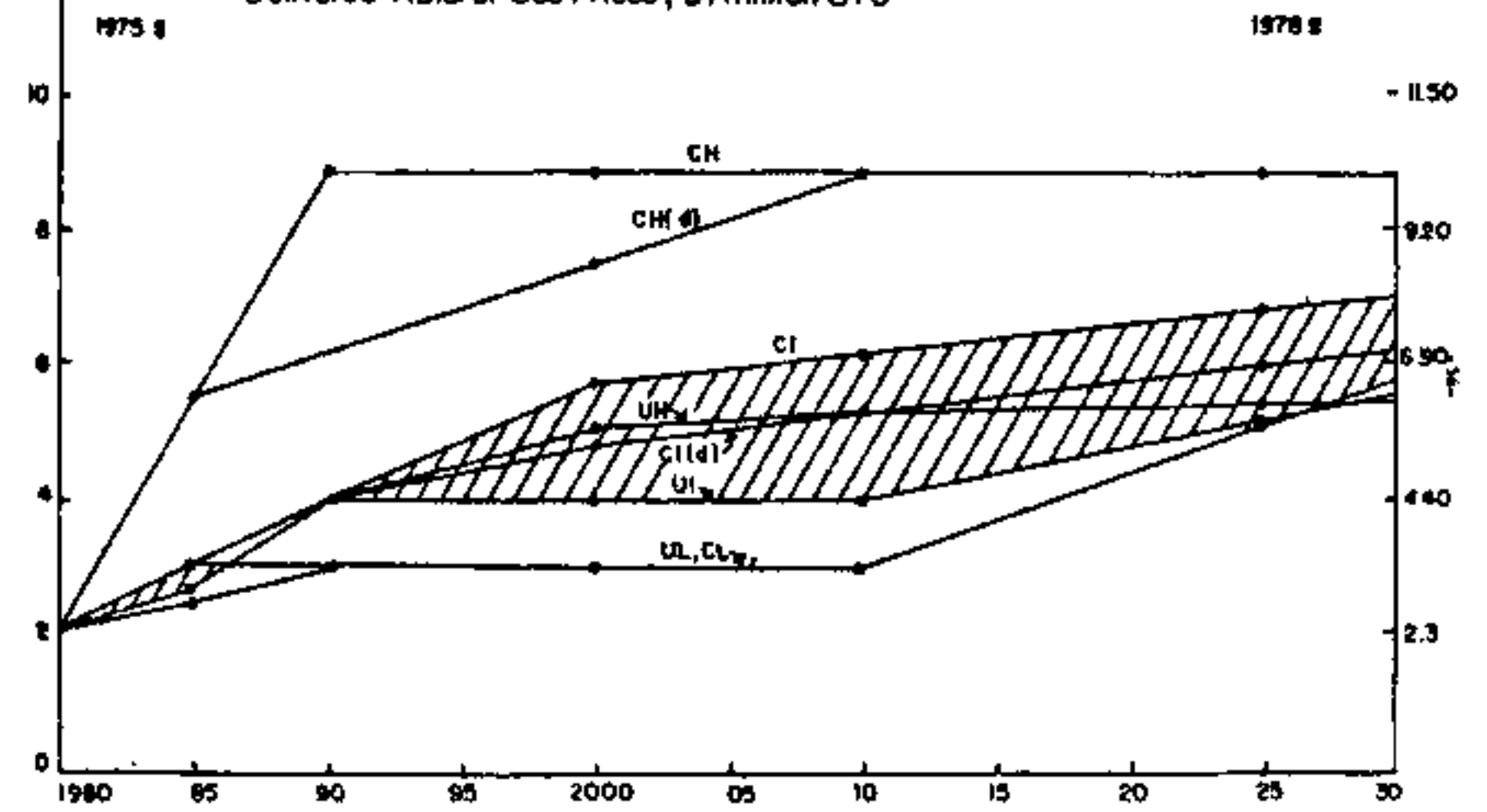

634

Delivered Coal Prices, \$/million BTU

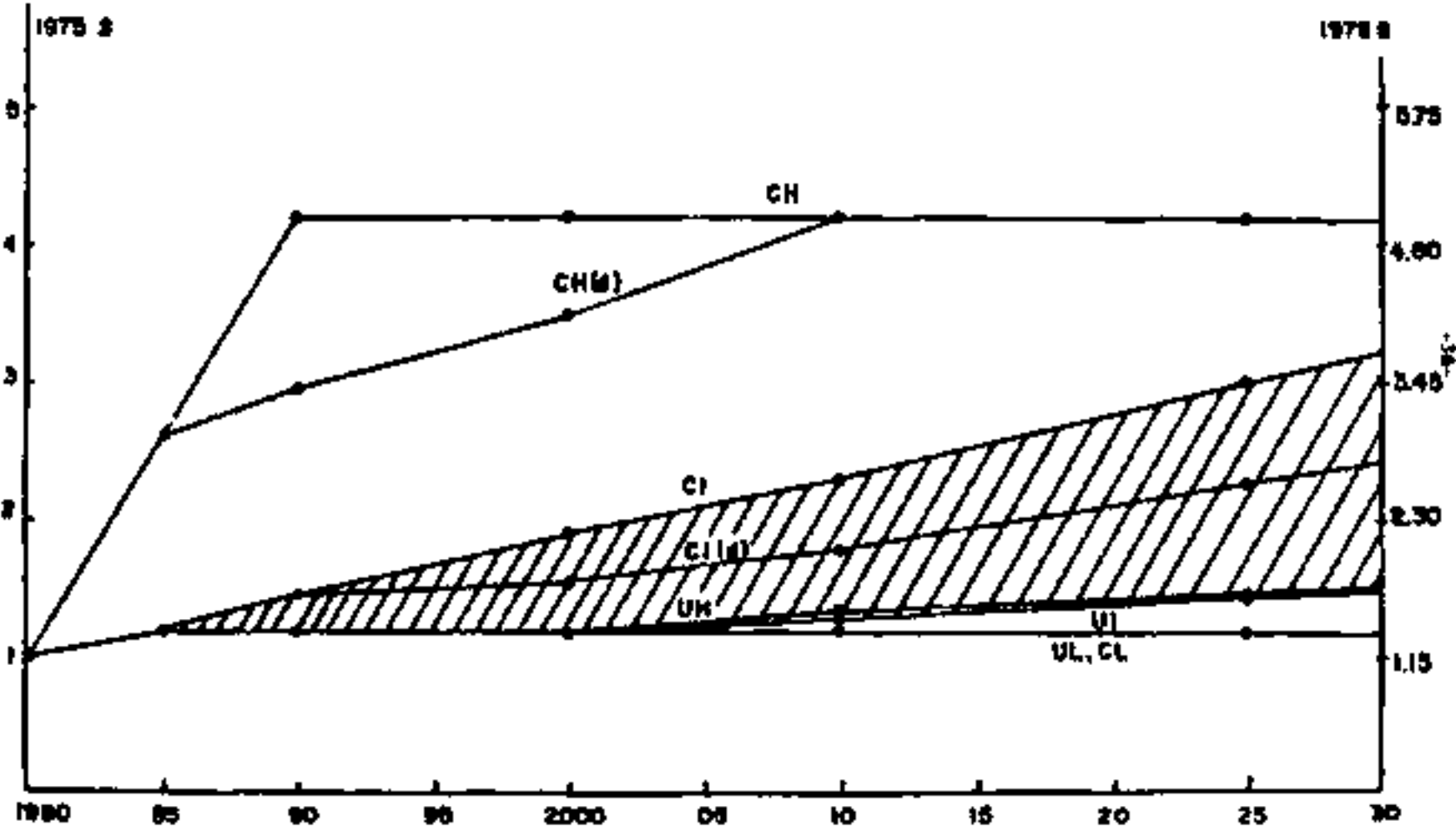

Electricity Prices, \$/million BTU

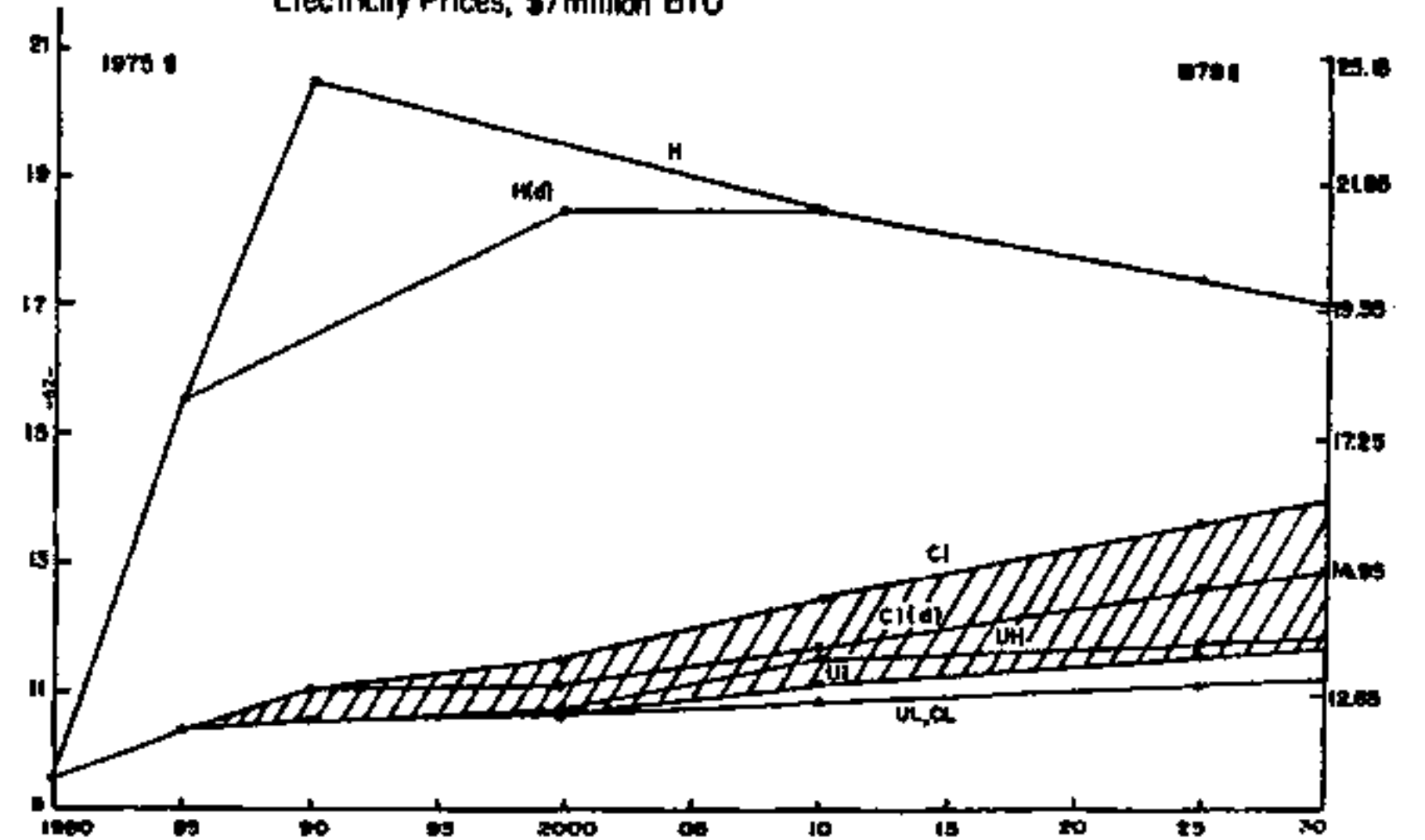

UNCERTAINTY IN ENERGY COST COMPARISONS
 John K. Bragg
 Consultant to Argonne National Laboratory
 100 West 57th Street, New York, New York 10019

The uncertainty in projecting energy system costs into the future is so great that a single number comparison of the life-cycle cost of different systems may be misleading as a basis for decision. However, it is also difficult to put comparisons on a probabilistic basis, particularly when the major cost elements of two competing systems are different in character. The present work illustrates some of the problems in a comparison of SPS and coal technologies for the generation of electricity.

The major uncertainties in this comparison are the levelized cost of coal over the remote 2000-2030 A.D. time span, and the capital cost of the SPS system. The cause in the first case is primarily economic, in the second case technological. The methodology reported in this work primarily addresses the first question.

Economic Uncertainty

Projecting an economic quantity far into the future produces results that depend on hypothesis - "if the following things happen, then the result will be. . ." - without knowing the likelihood of the hypothesized set of circumstances. This problem is inescapable.

The present work is not an attempt to resolve the basic problem. It does provide a framework for illustration of problems of uncertainty in energy comparison, in which the structure of the remote future is not arrived at by a conjectural leap, but rather by a year-to-year "random walk" whose parameters are easily recognized in the past. Specifically, the value of an economic quantity in the year n , Q_n , is related to Q_{n-1} by a factor f_n which is assumed to be a random variable with an appropriate mean $1 + \mu$ and standard deviation σ , both independent of n . Here μ is the appropriate compound growth rate and σ expresses year-to-year fluctuations about the mean.

Historical values of such quantities may be determined from least-squares logarithmic fits of historical economic series; for example:

	mean real growth rate % per year	standard deviation of
real coal prices, 1950-1968	-1.2%	3.5%
real coal prices, 1968-1977	11	14
real electric equipment prices 1964-1977	-1.5	1.7
real construction prices, 1964-1977	1.9	2.6
transport & utility labor cost 1964-1977	1.6	3.0

The mean real growth rates might be called "scenario variables" and it cannot be assumed that they will be the same in the future. However the observed fluctuations may give some guidance to random behaviour in the future.

It is possible to formulate the life-cycle cost, or equivalently the levelized cost, of the major elements of electric utility system costs (fixed costs, fuel

costs, O&M) in terms of such quantities. A typical relation is:

$$\text{Levelized Cost} \propto \sum_{i=k+1}^n (1 - \alpha)^i \prod_{j=1}^i (1 + \mu + \eta_j),$$

where the η_j are random variables with mean zero and standard deviation σ . An exact solution for the mean and variance (although not the entire distribution) of the levelized costs, regarded as random variables, can be obtained.

Another problem in such comparisons is to take correlations into account. If, for example, the cost of electric equipment for one system is high it will probably be high for an alternative. This is dealt with by formulating the difference between levelized costs as the random variable. The result is to indicate a wider difference between two technologies than if correlations were ignored.*

Technical Uncertainty

The major uncertainty regarding the capital cost of SPS is with the nature and performance of the ultimate configuration. The solar cells and the space transportation and construction are the main uncertain elements. There is little basis in experience for these costs other than the observation that early estimates of such costs are consistently low. This suggests the use of a skewed probability distribution of SPS costs.

An estimate of the most probable cost of SPS installations in production has been provided by M. Samsa of Argonne National Laboratory; namely \$3,650 per kilowatt (1978 \$), together with a lower limit of \$3,150. In lieu of an upper limit, which is much more conjectural, I have used a parameter f , which is the probability that the SPS capital cost lies below the most probable value. In accordance with the above the value of f is assumed to be less than 0.5. The shape of the distribution is only of significance to these calculations below the most probable value, and I have assumed a straight line.

To illustrate the kind of comparison that is possible the input numbers for an example are assumed to be:

	Mills/ Kwhr. today	μ	σ
Coal Plant O&M	3.1	0	.030
SPS Plant O&M	5.2	0	.030
Fuel Cost	10.0	.024	.030
Most probable cost, coal plant	8.0	.015	.022
Most probable cost, SPS plant	41.0**	0	.022

* Another problem with correlations, whose correct treatment will generally have the opposite influence, arises if the capital cost of a single system is treated as the sum of independently costed subsystems. This effect is not studied here.

** This estimate of today's cost is based on the assumed solution of all technical problems leading to full production. All initial numbers were furnished by M. Samsa of Argonne National Laboratory.

Figure 1 shows, as a function of the initial year of a typical satellite's life, curves of constant probability that the difference between levelized cost of electricity from SPS and from coal is less than the indicated values.

This figure is calculated for a fixed value of the standard deviation of year-to-year fuel cost change, $\sigma_f = 0.03$. Another calculation, Figure 2, shows this parameter as abscissa and varies f as well.

In the complete report of this work a number of parameter combinations are explored and comparisons made. Correlations taken approximately into account are: net energy content of SPS plant correlated with fuel prices; O&M costs of the two technologies correlated; costs of plant (excluding net energy content) correlated. Monte Carlo calculations were made to support the validity of the normal approximation to the actual distribution of levelized cost differences.

FIGURE 1

SPS-COAL COMPARISON

Silicon solar cells
Scenario CI (2.4%/yr.
increase in coal prices)
 $f = 0.2, \sigma_f = .03$

638

Δ = levelized
cost difference
(mills/kwhr.)

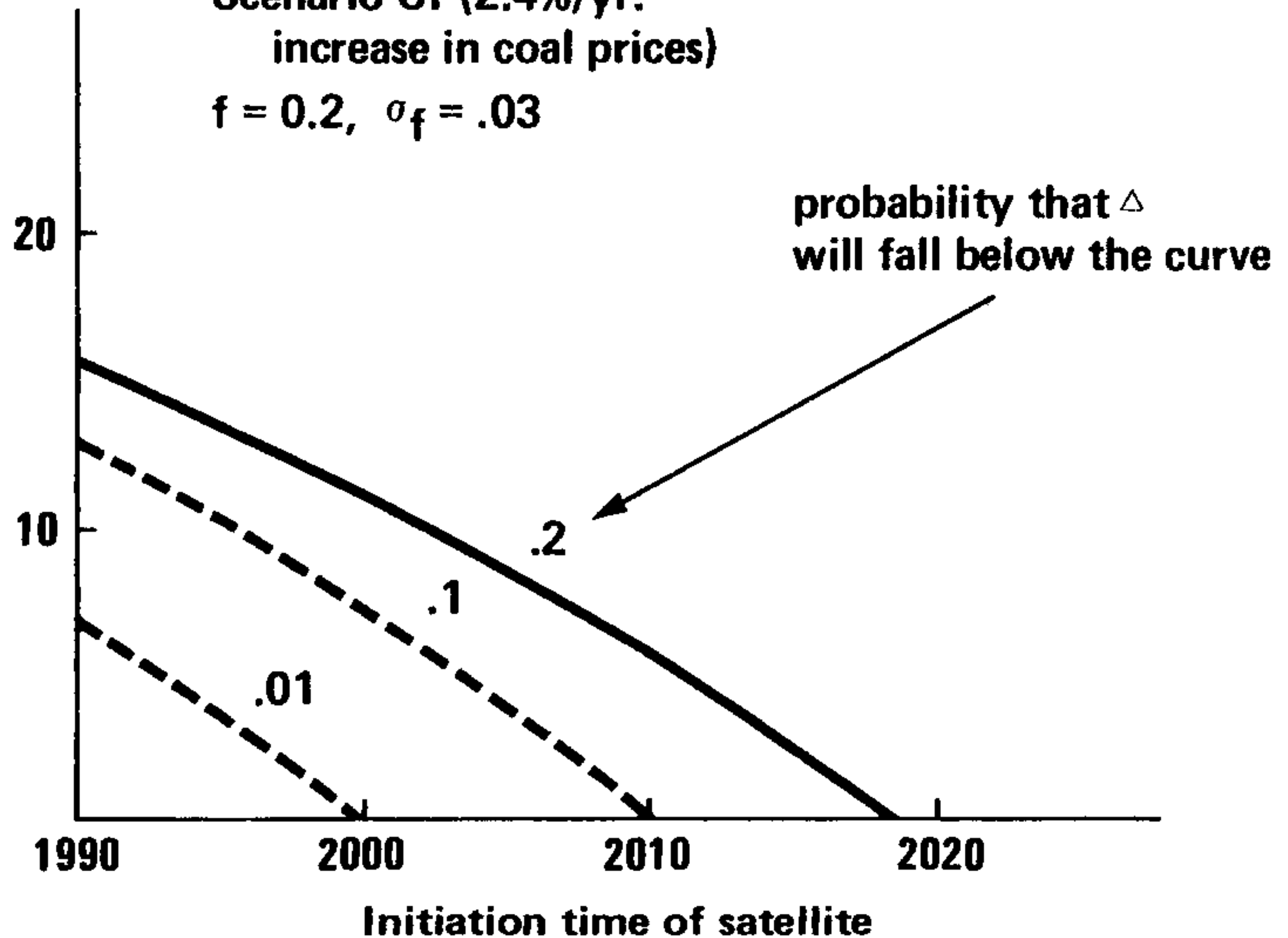

SPS-COAL COMPARISON

silicon solar cells
scenario CI (2.4%/yr.
increase in coal prices)

P of success
for SPS

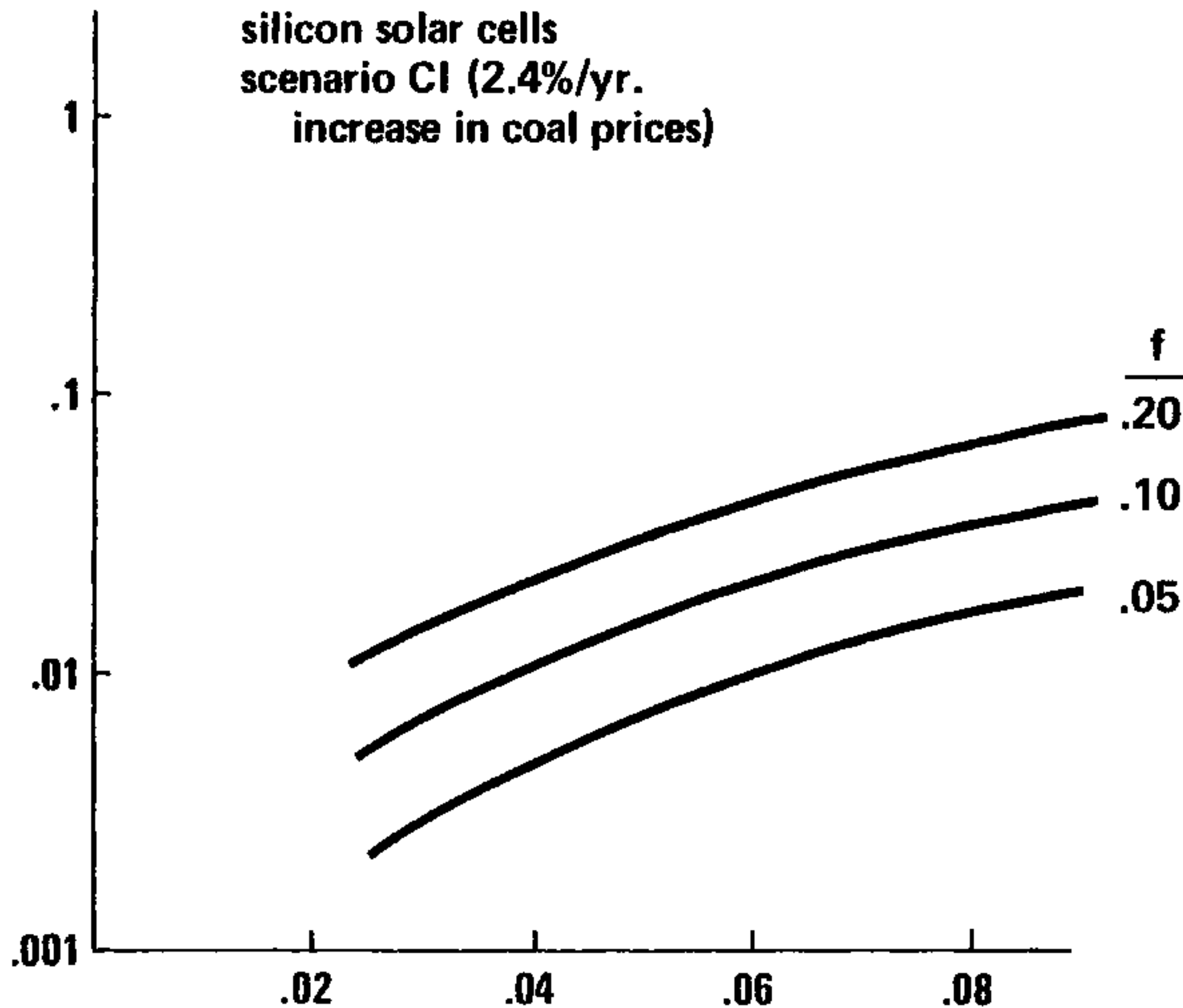

standard deviation of year-to year
fluctuations in fuel prices

f = probability that SPS plant cost
falls below the modal value \$3650/kw.

AUTHORS INDEX

<u>NAME & ORGANIZATION</u>	<u>PAPER TITLE</u>	<u>PAGE</u>
AASEN, M. D. ITT Research Institute	The EMC of Satellite Power Systems and DoD C-E Systems	424
AINSWORTH, E. J. Lawrence Berkeley Labs.	Late Biological Effects of Heavy Charged Particles: Cataracts, Vascular Injury and Life Shortening in Mice	477
ALLEN, R. E. United Engineers & Constructors	Satellite Power System Cost Review	618
ALMGREN, D. W. Arthur D. Little, Inc.	Evaluation of Solar Cell Materials for a Solar Power Satellite ¹	263
ALPEN, E. L. Lawrence Berkeley Labs.	Late Biological Effects of Heavy Charged Particles: Cataracts, Vascular Injury and Life Shortening in Mice	477
ANDLAUER, G. Consultant - France	The Infrared Alternative	237
ANDRYCZYK, R. W. General Electric	Integration of SPS with Utility System Networks	99
	SPS Rectenna System	323
ANKERBRANDT, S. D. Planning Research Corp.	An Evaluation of the Land and Material Requirements for the Satellite Power System	125
ARIMURA, I. Boeing Aerospace Company	Proton Damage Annealing Kinetics in Silicon Solar Cells	254
ARNDT, G. D. NASA/JSC	Microwave System Performance Summary	277
	Smaller SPS System Sizing Tradeoffs	297
ATKINSON, J. H. DOD/ECAC	The EMC of Satellite Power Systems and DoD C-E Systems	424
AYRES, R. U. Carnegie-Mellon University	Macroeconomic/Socioeconomic Comparisons of SPS and Alternative Energy Technologies	610
	Alternative Future Energy Price/Demand Scenarios	631

	Page
BACHRACH, A. Environmental Resources Group	525
BAILEY, D. G. IBI Group	511
BARKER, M. E. Lawrence Berkeley Labs.	477
BATTISTA, S. P. Arthur D. Little, Inc.	383
BAVINGER, W. A. Rice University	517
BEATTIE, DONALD NASA/HQ	10
BEHNKE, R. Arecibo Observatory	489
BENNETT, J. C. L-5 Society	542
BENSON, H. E. NASA/JSC	301
BERGERON, R. P. Rockwell International	204
BERMAN, E. Environmental Research Ctr., EPA	387
BERNHARDT, P. A. Stanford University	487
BLACKBURN, J. B., JR. Rice University	517
BLOCK, R. S. University of Pennsylvania	603
BLOOMQUIST, C. E. Planning Research Corp.	54
BOHN, J. G. Systems Control, Inc.	625

	Page
BORUCKI, W. J. NASA/ARC	Environmental Effects of SPS; The Middle Atmosphere 458
BOSSONG, K. Citizens' Energy Project	Concerns of the Citizens' Energy Project About the SPS 540
BRAGG, J. K. Consultant	Uncertainty in Energy Cost Comparisons 635
BRANTLEY, L. W., JR. NASA/MSFC	Power Conversion Perspective 243
BROWN, C. D. Argonne National Lab.	Comparative Health and Safety Assessment of the SPS and Alternative Electrical Generation Systems 150
BROWN, P. E. United Engineers and Con- structors	Satellite Power System Cost Review 618
BROWN, W. C. Raytheon Company	Rectenna System Design 328 Power Amplifiers (Tube) 336
BROWNELL, J. R., JR. KAPPA Systems, Inc.	Alternative International Political Re- actions to SPS 512
BRUBAKER, K. L. Argonne National Lab.	Ground Cloud Air Quality Effects 445 Overview of HLLV Effluents in Strato- sphere and Above 450
BYMAN, D. Boston University	SPS Microwave Effects on Airborne Biota Status Report 383
CAHILL, D. F. Environmental Research Ctr., EPA	SPS Microwave Health and Ecological Effects- Program Area Overview 124 Microwave Health and Ecological Effects Overview 378
CAMBEL, A. B. George Washington University	Energy Implications of an Aging Popula- tion 536
CAPONE, L. A. San Jose State University	Environmental Effects of SPS: The Middle Atmosphere 458
CASSADY, P. Mathematical Sciences North- west, Inc.	Solar Driven Lasers for Power Satellite Applications 267

		Page
CHACKO, C. C. Boston University	Ionospheric Observations: Archived Data and the HEAO-C Launch	480
CHAPMAN, P. K. Arthur D. Little, Inc.	Encounters Between SPS Power Beams and Satellites in Lower Orbit	428
	The Industrial Infrastructure for the Solar Power Satellite	575
	Technology Alternatives for the SPS	216
CHIU, Y. T. The Aerospace Corporation	Plasmaspheric and Magnetospheric Effects of POTV and COTV Effluents	493
COCO, D. S. Rice University	SPS Heating in the Lower Ionosphere, An Experimental View	408
COLLINS, P. Q. Imperial College of Science and Technology	Potential for Reception of SPS Microwave Energy at Offshore Rectennas in Western Europe	529
COOK, E. J. Arthur D. Little, Inc.	SPS Microwave Effects on Airborne Biota Status Report	383
CRIST, M. S. Consultant	Institutional Considerations of SPS/ Utility Integration	581
CRISWELL, D. R. University of California, San Diego	Recent Work on Use of Lunar Materials for SPS Construction	223
CSIGI, K. I. Arthur D. Little, Inc.	Evaluation of Solar Cell Materials for a Solar Power Satellite ¹	263
CURTIS, S. A. NASA/GSFC	Effects of Argon Ion Injections in the Plasmasphere	501
DALY, J. C. University of Rhode Island	Passive Solar Reflector Satellite Re- visited	231
DAURIO, A. P. Planning Research Corp.	Societal Assessment - International Issues	133
DAVID, L. W. PRC Energy Analysis Co.	A Study of Federal Microwave Standards	552
DAVIS, K. C. Battelle-PNL	Electromagnetic Compatibility Overview	120
	Summary of the Electromagnetic Compati- bility Evaluation of the Proposed Satellite Power System	414

	Page
	431
	254
DAY, A. C. Boeing Aerospace Company	536
DeVITA, C. J. Georgetown University	328
DICKINSON, R. M. NASA/JPL	273
DIETZ, R. H. NASA/JSC	408
DJUTH, F. T. Rice University	574
DOOLING, D. The Huntsville Times	219
DREXLER, K. E. MIT Space Systems Lab.	352
	234
DRUMMOND, J. E. Power Conversion Technology, Inc.	410
	489
DUNCAN, L. M. Los Alamos Scientific Lab.	407
	88
DYBDAL, K. K. St. Olaf College	622
EARHART, R. W. Battelle Columbus Labs.	

	Page
ENTRES, S. L. General Technology Systems, Ltd.	Some Judicial and Regulatory Factors 562
FLEISCH, D. A. Rice University	SPS Heating in the Lower Ionosphere, An Experimental View 408
FORBES, J. M. Boston College	Mesospheric Cloud Formations 452 D- and E-Region Effects 454
FRANKLIN, H. A. Bechtel National, Inc.	The Design of Low-Cost Structures for Extensive Ground Arrays 185
FRANKLIN, I. V. British Aerospace	Some Aspects of SPS Acceptability in Europe 508
FREEMAN, J. W. Rice University	Microwave Power Transmission Workshop Summary 345 Offshore Rectenna Feasibility 348
GANGULY, S. Rice University	SPS Heating in the Lower Ionosphere, An Experimental View 408
GARY, N. E. University of California	Study of the Biological and Ecological Effects of SPS Microwave Power on the Honey Bee 379
GASPER, J. R. Argonne National Lab.	Comparative Health and Safety Assessment of the SPS and Alternative Electrical Generation Systems 150
GE, X. S. China University of Science and Technology	Research on the Use of Solar Energy in the Department of Engineering Thermo- physics, China University of Science and Technology 614
GIUDICI, R. J. NASA/MSFC	Electric Power Processing, Distribution, Management and Energy Storage 359
GLASER, P. E. Arthur D. Little, Inc.	Evaluation of Solar Cell Materials for a Solar Power Satellite ¹ 263 Technology Alternatives for the SPS 216 Offshore Rectenna Feasibility 348 The Industrial Infrastructure for the Solar Power Satellite 575 An Historical Perspective on the Solar Power Satellite Concept 1

		Page
GOODMAN, F. R., JR. Electric Power Research Institute	Utility System Impacts of the Satellite Power System	579
GORDON, A. I. Rockwell International	Satellite Power System Operations	368
GORDON, W. E. Rice University	Ionosphere/Microwave Beam Interactions: Arecibo Experimental Results	407
GOROVE, S. University of Mississippi Law Center	Internationalization of the SPS: U. S. Policy Issues, Options and Strategies	514
GRAN, R. Grumman Aerospace Corp.	A Modern Control Approach to the Design of the SPS Control System	180
GRANT, W. B. DOC/NTIA/ITS	The EMC Impact of SPS Operations on Low Earth Orbit Satellites	431
	Summary of the Electromagnetic Compati- bility Evaluation of the Proposed Satellite Power System	414
GREBOWSKY, J. M. NASA/GSFC	Effects of Argon Ion Injections in the Plasmasphere	501
GREENBERG, H. S. Rockwell International	Satellite Power Systems Structures - A 1980 Technology Status Review	172
GUO, K. L. China University of Science and Technology	Research on the Use of Solar Energy in the Department of Engineering Thermo- physics, China University of Science and Technology	614
GUTTMAN, C. H. NASA/MSFC	SPS Technical Issues	107
HABEGGER, L. J. Argonne National Lab.	Comparative Health and Safety Assessment of the SPS and Alternative Electrical Generation Systems	150
HAMILTON, C. W. Battelle Columbus Lab.	Preliminary Planning for Future SPS Microwave Health and Ecology Research and Assessment	396
	Critical Review of Satellite Power Sys- tems (SPS) Space Transportation Cost Estimates	622
HANLEY, G. M. Rockwell International	Emerging SPS Concepts	95

	Page
	200
Earth-to-Orbit Transportation for Solar Power Satellites	
HARLAN, A. L-5 Society	542
HAZELRIGG, G. A., JR. ECON, Inc.	598
HEFFERNAN, G. A. George Washington University	536
HENDERSON, R. A. British Aerospace	356
HENSON, C. M. L-5 Society	542
HEPPENHEIMER, T. A. Center for Space Science	227
	590
	208
HERVEY, D. G. Brown & Root Development, Inc.	348
HILL, J. A. Environmental Resources Group	469
	583
HOLZE, D. H. Boeing Aerospace Company	496
	464
HOMATAS, G. E. Polytechnic Institute of New York	556
HOPKINS, M. M. Rand Corporation	600

		Page
HORAK, H. G. Los Alamos Scientific Lab.	The Lagopedo Experiments	483
HORNE, W. E. Boeing Aerospace Company	Proton Damage Annealing Kinetics in Silicon Solar Cells	254
HOYT, D. Harvard University	SPS Microwave Effects on Airborne Biota Status Report	383
HULL, W. E. NASA/JSC	Effects of the Space Environment on the Health and Safety of Space Workers	473
HYSON, M. T. California Institute of Technology	Sunlight Reflections from a Solar Power Satellite or Solares Mirror Should Not Harm the Eyes	460
IRWIN, N. A. IBI Group	Strategies for Marshalling International Support for Solar Power Systems	511
JAMIESON, W. M. Battelle Columbus Labs.	Preliminary SPS Materials Assessment	531
JOHNSON, O. E. Boeing Aerospace Company	Economic Potential of SPS	594
JONES, R. M. Jet Propulsion Lab.	The Applicability of MPD Thrusters to Satellite Power Systems	210
JOSE, J. G. Lawrence Berkeley Labs.	Late Biological Effects of Heavy Charged Particles: Cataracts, Vascular Injury and Life Shortening in Mice	477
JUANG, J. N. Jet Propulsion Lab.	Dynamics and Control of the Satellite Power System	176
JUROSHEK, J. R. DOC/NTIA	The SPS Interference Problem - Electronic System Effects and Mitigation Techniques	435
KAPLAN, J. N. SRI International	Biological Effects of Chronic Pre- and Post-natal Exposure of Squirrel Monkeys to SPS Frequency Microwaves	392
KAPLAN, M. S. U.S. General Accounting Office	Satellite Power System (SPS): The Need for Detailed Assessment to Develop Feasible Management Schemes	558
KASSING, D. ESTEC	Critical Technology Areas of an SPS Development and the Applicability of European Technology	109
KAUPANG, B. M. General Electric	Integration of SPS with Utility System Networks	99
	SPS Rectenna System	323

		Page
KELLERMEYER, D. A. HDR Ecosciences	Climate and Energy: A Comparative Assessment of SPS and Alternative Energy Technologies	613
KLINEBERG, S. L. Rice University	Social Acceptability of Satellite Power Systems: A Preliminary Exploration	534
KLOSTERMAN, E. Mathematical Sciences Northwest, Inc.	Solar Driven Lasers for Power Satellite Applications	267
KOELLE, D. E. Messeerschmitt-Bolkow-Blohm GmbH Space Division	Minimum Cost Criteria for SPS Transportation to GEO	196
KOOMANOFF, F. A. U.S. Department of Energy	Satellite Power System Concept Development and Evaluation Program: The Assessment Process	15
	Summary: SPS Program Review	162
KOTIN, A. D. Kotin & Regan, Inc.	Relationship of Eligible Areas to Projected Electrical Demand	521
KUBITZ, K. R. Pacific Gas & Electric Co.	Electric Utility Requirements Affecting Solar Power Satellite Development and Deployment	587
KUNZ, T. H. Boston University	SPS Microwave Effects on Airborne Biota Status Report	383
LADWIG, A. D. FASST	Concerns of FASST About the Solar Power Satellite	544
LAYTON, J. P. Consultant	Satellite Power Systems (SPS) Space Transportation Workshop Summary	214
LEAVITT, J. A. Epstein & Sons, Inc.	Active Control of Deflections in Space Structures	184
LEBEDA, C. F. EG&G, Inc.	Ice Formation During Lagopedo Uno	485
LE-CONG, P. Power Conversion Technology, Inc.	Laboratory and Proposed Ionospheric Experiments on SPS Microwave Instability	410
LEE, J. Argonne National Lab.	Ground-Cloud-Related Weather Modification Effects	446
	Rectenna-Related Atmospheric Effects	440

		Page
LEONARD, R. S. Consultant	The Design of Low-Cost Structures for Ex- tensive Ground Arrays	185
	Automated Construction of Lightweight, Simple, Field-Erected Structures	324
	A Different Race	564
LIEMOHN, H. B. Boeing Aerospace Company	Characterization of Reflected Light From the Space Power System	464
	Disposition of SPS Electric Thruster Ex- haust	496
LINDSEY, W. C. LinCom Corporation	Phase Control System Concepts and Simu- lations	285
LIVINGSTON, L. E. NASA/JSC	SPS Overview: Requirements, Alternatives, and Reference System	91
LLOYD, W. Marsh & McLennon, Inc.	Satellite Power System: Initial Insur- ance Evaluation	555
LOVBERG, R. Power Conversion Tech., Inc.	Laboratory and Proposed Ionospheric Ex- periments on SPS Microwave Instability	410
LYMAN, J. T. Lawrence Berkeley Lab.	Hazards to Space Workers from Ionizing Radiation in the SPS Environment	475
MacDANIEL, W. E. Niagara University	Sources and Nature of Resistance to Satel- lite Power System (SPS) Development	570
MAHER, K. Battelle Columbus Lab.	Critical Review of Satellite Power Systems (SPS) Space Transportation Cost Estimates	622
McCAFFREY, R. W. Grumman Aerospace Corporation	Specific SPS Construction Studies: Con- struction Tasks-Construction Base	310
McCOY, J. E. NASA/JSC	High Voltage Space Plasma Interactions	372
McHUGH, D. Polytechnic Institute of New York	Problems and Prospects for an SPS Role in New York State's Energy Future: A Major Case Study of Concept Viability	556
McNEAL, S. R. Planning Research Corp.	Public Concerns	135
McRAE, W. V., JR. Rockwell International	Satellite Power System Total Proof-of- Concept Program	240
	Specific Construction Tasks	307

		Page
MELTZ, G. United Technology Research Center	Microwave Heating of the Lower Ionosphere	403
MENDILLO, M. Boston University	Ionospheric Observations: Archived Data and the HEAO-C Launch	480
MILLER, K. H. Boeing Aerospace Company	Specific SPS Construction Studies: Operations and Maintenance	319
MINGORI, D. L. UCLA	SPS Structural Dynamics and Control Workshop: Findings and Recommendations	189
MONFORD, L. NASA/JSC	Smaller SPS System Sizing Tradeoffs	297
MORRISON, E. L., JR. DOC/NTIA/ITS	Summary of Electromagnetic Compatibility Evaluation of the Proposed Satellite Power Systems	414
	The EMC Impact of SPS Operations on Low Earth Orbit Satellites	431
MOSS, R. H. Pacific Gas & Electric Co.	Electric Utility Requirements Affecting Solar Power Satellite Development and Deployment	587
NALOS, E. J. Boeing Aerospace Company	Rectenna System Design	328
	Microwave System Performance Summary	277
NIGHAN, W. L. United Technology Research Center	Microwave Heating of the Lower Iono- sphere	403
NUSSBERGER, A. A. Rockwell International	Gallium Arsenide (GaAs) Power Conversion Concept	246
	High Voltage Systems (Tube-Type Micro- wave)/Low Voltage Systems (Solid-State Microwave) Power Distribution	364
OGLEVIE, R. E. Rockwell International	SPS Attitude Control and Stationkeeping - Requirements and Tradeoffs	168
O'NEIL, G. K. Princeton University	Recent Work on Use of Lunar Materials for SPS Construction	223
OTT, J. H. Novar Electronics Corp.	An Interferometer-Based Phase Control System	289
	A Power Satellite Sonic Simulator	293

	Page
	328
	332
PARK, C. NASA/ARC	458
PASSERINI, E. University of Alabama	568
PATE, D. S. Solar Energy Coalition	572
PATMORE, J. W. Systems Control, Inc.	625
PEWITT, N. D. U.S. Department of Energy	9
PHELPS, D. Power Conversion Technology, Inc.	410
PILAND, R. O. NASA/JSC	142
	103
POLK, C. University of Rhode Island	231
PONGRATZ, M. B. Los Alamos Scientific Lab.	483
	485
PRASAD, S. S. Jet Propulsion Lab.	458
PUGH, F. L. IBM	368
RABE, J. Environmental Resources Group	583
REINHARTZ, K. K. European Space Agency	78

		Page
RICE, J. S. Novar Electronics, Inc.	An Interferometer-Based Phase Control System	289
	A Power Satellite Sonic Simulator	293
	A Theoretical Study of Microwave Beam Absorption by a Rectenna	332
RICHARDSON, J. NAS	Involvement in SPS: NAS	12
RICHES, M. R. U.S. Department of Energy	A Comparative Assessment of the Reference Satellite Power System with Selected Current, Near-Term and Advanced Energy Technologies	66
RIED, R. C. NASA/JSC	SPS Structures and Control: A Perspective	164
	SPS Structural Dynamics and Control Workshop: Findings and Recommendations	189
RIEGEL, C. A. San Jose State University	Environmental Effects of SPS: The Middle Atmosphere	458
RODRIGUEZ, G. Jet Propulsion Lab.	Dynamics and Control of the Satellite Power System	176
ROSI, F. D. University of Virginia	A Survey of the Market, Supply and Availability of Gallium	258
ROTE, D. M. Argonne National Labs.	Atmospheric Effects Overview	439
	Overview of Atmospheric Effects	113
RUDOLPH, L. K. Jet Propulsion Lab.	The Applicability of MPD Thrusters to Satellite Power Systems	210
RUSH, C. M. DOC/NTIA/ITS	Ionospheric Disturbance Overview	116
RUTH, J. ESTEC	Critical Technology Areas of an SPS Development and the Applicability of European Technology	109
SAMSA, M. E. Argonne National Lab.	Alternative Advanced Power Generation Technology Characterizations	627
	SPS and Alternative Technologies Cost and Performance Evaluations	146

		Page
SCHROEDER, K. G. Rockwell International	Solid-State Configurations	340
SCHWENK, F. C. NASA/HQ	Overview of Systems Definition Activities for Satellite Power System	21
SCHUSTER, G. J. Battelle-PNL	SPS Effects on Optical Astronomy	423
SEYL, J. W. NASA/JSC	Satellite Power System Concept Development and Evaluation Program Critical Supporting Investigations "Summary"	281
SHELTON, R. M. British Aerospace	Some Aspects of SPS Acceptability in Europe	508
SHOTLAND, S. I. Planning Research Corp.	Societal Assessment - Institutional Issues	129
SHOWEN, R. L. SRI International	Simulated D-and E-Region Effects of the SPS Power Beam	400
SIMONS, D. J. Los Alamos Scientific Lab.	The Lagopedo Experiments	483
SMITH, G. M. Los Alamos Scientific Lab.	The Lagopedo Experiments	483
SPERBER, B. R. Boeing Aerospace Company	High-Power Microwave Optics for Flexible Power Transmission Systems	352
	Prototype Solar Power Satellite Options	219
	Characterization of Reflected Light from the Space Power System	464
STARK, J. P. British Aerospace	SPS Power Transmission - Are Multiple Beams a Better Option for Europe?	356
STEIN, B. NSF	Involvement in SPS: NSF	11
STOIL, M. J. KAPPA Systems, Inc.	Alternative International Political Reactions to SPS	512
STONE, S. N. Los Alamos Scientific Lab.	Effects of Rocket Exhaust Products in the Thermosphere and Ionosphere	489
SUTHERLAND, C. D. Los Alamos Scientific Lab.	Effects of Rocket Exhaust Products in the Thermosphere and Ionosphere	489
	The Lagopedo Experiments	483

		Page
SVIEDRYS, R. Polytechnic Institute of New York	Problems and Prospects for an SPS Role in New York State's Energy Future: A Major Case Study of Concept Viability	556
TAYLOR, T. C. Taylor and Associates	Construction of the SPS Primary Structure by Another Method	316
TAUSSIG, R. T. Mathematical Sciences Northwest, Inc.	Solar Driven Lasers for Power Satellite Applications	267
TEETER, R. R. Battelle Columbus Lab.	Critical Review of Satellite Power Sys- tems (SPS) Space Transportation Cost Estimates	622
	Preliminary SPS Materials Assessment	531
THOMPSON, A. R. National Radio Astronomy Observatory	The Effect of a Satellite Power System on Ground-Based Astronomy	419
THOMPSON, W. Power Conversion Tech- nology	Laboratory and Proposed Ionospheric Ex- periments on SPS Microwave Instability	410
THORN, D. C. Novar Electronics, Inc.	A Theoretical Study of Microwave Beam Absorption by a Rectenna	332
TINGEY, D. L. Boeing Aerospace Company	Characterization of Reflected Light from the Space Power System	464
TURCO, R. P. R&D Associates	Environmental Effects of SPS: The Middle Atmosphere	458
VAJK, J. P. Science Applications, Inc.	Military Implications of Satellite Power Systems	506
VALENTINO, A. R. Argonne National Lab.	Environmental Assessment Overview	36
WALES, W. W., JR. NASA/MSFC	SPS Program Review Transportation Per- spectives	193
WANG, S. J. Jet Propulsion Lab.	Dynamics and Control of the Satellite Power System	176
WASSERMAN, F. A. Boston University	SPS Microwave Effects on Airborne Biota Status Report	383
WEIR, D. G. RCA Laboratories	Solid State Technology	344

		Page
WESTERDAHL, B. B. University of California	Study of the Biological and Ecological Effects of SPS Microwave Power on the Honey Bee	379
WHITE, M. R. Lawrence Berkeley Labs.	Non-Microwave Health and Ecological Effects: Overview	122
WHITFIELD, R. G. Argonne National Lab.	Environmental Welfare Comparison	154
	Resources/Macroeconomic/Institutional Comparative Assessment	158
WHITTEN, R. C. NASA/ARC	Environmental Effects of SPS: The Middle Atmosphere	458
WILLIAMS, J. R. Georgia Institute of Technology	Conclusions of the Huntsville SPS Power Conversion Workshop	271
	SPS Power Management Workshop Summary	376
WILLIAMSON, R. A. OTA	SPS and the Office of Technology Assessment	8
WILSON, W. B. Teknekron Research, Inc.	Environmental Welfare Effects Evaluation	612
	Resource Comparisons (Land, Water and Materials)	607
WOLCOTT, J. H. Los Alamos Scientific Lab.	The Lagopedo Experiments	483
WOLSKO, T. C. Argonne National Lab.	A Methodology for the Comparative Assessment of the SPS and Alternative Technologies	138
WOOD, R. D. Central Washington University	A Societal Assessment of Student Participation in the Evaluation of the Satellite Power System Concept	548
WOODCOCK, G. R. Boeing Aerospace Company	Emerging SPS Concepts	95
	Earth-to-Orbit Transportation for Solar Power Satellites	200
	SPS Silicon Reference System	250
	Integrated Space Operations Overview	303
	High Voltage Systems (Tube-Type Microwave)/Low Voltage Systems (Solid-State Microwave) Power Distribution	364

		Page
WOODWARD, H. T. NASA/ARC	Environmental Effects: The Middle Atmosphere	458
YOUNGSTROM, K. A. Manoment Bird Observatory	SPS Microwave Effects on Airborne Biota Status Report	383
ZIEGLER, E. J. United Engineers and Con- structors	Satellite Power System Cost Review	618
ZINN, J. Los Alamos Scientific Lab.	Effects of Rocket Exhaust Products in the Thermosphere and Ionosphere	489
	The Lagopedo Experiments	483

SOLAR POWER SATELLITE PROGRAM REVIEW

GLOSSARY

Absorption	The process in which incident radiant energy is retained by a substance.
Angle of incidence	The angle at which a ray of energy or an object impinges upon a surface. It is measured between the direction of propagation of the energy or object and a perpendicular to the surface at the point of impingement or incidence.
Angstrom	A unit of measure equalling 10^{-10} meter.
Automated beam builder	A device that continuously produces structural beams, from coils of metal, to build structures in space.
Blanket	A sheet of photovoltaic cells.
British thermal unit (Btu)	A unit of energy defined as the heat required to raise the temperature of one pound of water one degree Fahrenheit; it is equal to 252.1 calories or 1055 joules.
Beam width	The angular width of a beam of radiation, measured between the directions in which the power intensity is a specified fraction, usually one-half, of the maximum.
Closed Brayton cycle	A solar-thermal power-conversion process in which helium is compressed and then heated by solar energy causing the gas to expand. The expanding gas turns turbines which generate electricity. The heated helium then goes through a radiator, which rejects the heat into space and the cycle begins again.
Comparative assessment	A DOE comparison of the benefits and problems of SPS, and other circa-2000 potential energy options. SPS assessment subjects include cost and performance, environmental impacts, health and safety effects, resource utilization, economic and social factors, and institutional considerations.

Concentrating collector	A solar collector that contains reflectors, lenses or other optical elements to concentrate the energy falling onto the aperture onto a heat exchanger of surface area smaller than the aperture.
Concentration ratio	The amount that light is magnified or intensified by a focusing system.
Concentrator cell	A solar cell designed to accommodate light power densities much greater than the normal power density of sunlight at the surface of the earth. It can be used with focusing arrangements that increase the power of sunlight hundreds of times.
Cost effective	Denotes that an expenditure produces a benefit that is proportional or more than proportional to the cost, when compared to a norm or conventional arrangement.
Cost payback period	Denotes the time required to pay back an initial investment, through profits or cost reductions.
Cryogenics	The science that deals with the production of very low temperatures and their effects on the properties of matter. Normally refers to liquified gases such as hydrogen, oxygen and helium.
Efficiency, solar cell	The ratio of the electrical power output of a solar cell to the solar power that it intercepts.
Energy conversion	Denotes the changing of any form of energy into another form (i.e., converting sunlight to electricity by using photovoltaic cells).
Energy payback period	The time required for an energy-producing system to produce the same amount of energy that was consumed in designing and building the system.

Environmental assessment	A series of studies being conducted by DOE to determine the effects of SPS on the environment. Subjects include biological effects of microwaves, the effects of high energy atomic particles in geostationary space on space workers, the effects of reflected light from satellites, the impacts on optical astronomy and on ecology, the effects of SPS microwave beams on radio astronomy, the effects on telecommunication systems, etc.
Exclusion area	The area surrounding a receiving antenna (rectenna) from which people and possibly other creatures will be excluded in order to prevent any microwave-induced damage.
Faceted	Denotes a solar concentrator that uses a series of reflective, plane surfaces to intensify solar radiation.
Full sun	The amount of power density received at the surface of earth at noon on a clear day -- about 100mW cm^2 . Lower levels of sunlight are often expressed as a 0.5 sun or 0.1 sun. A figure of 0.5 sun indicates half the power density of a full sun.
Gallium arsenide	A chemical compound including the elements gallium, arsenic, and another element or a radical. Solar cells are often coated with this to improve efficiencies.
Gallium aluminum arsenide	A chemical compound including the elements gallium, arsenic and aluminum.
Geodesic dome	A hemispherically shaped structure made of plane surfaces. Pioneered by R. Buckminster Fuller.

Geostationary orbit	Denotes a point in space at which it takes an object 24 hours to circle the earth. Approximately 35,860 km (22,270 miles) above the earth's surface. A satellite at this point appears not to move when viewed from earth.
Geosynchronous	Geostationary.
Gigawatt	A billion watts.
Heat	A form of energy (sometimes called thermal energy) transferred between systems because of a difference in temperature and existing only in the process of energy transformation.
Heat capacity	The ratio of the heat absorbed or lost by a system to the corresponding temperature rise and fall.
Heat transfer	The transfer or exchange of heat by radiation, conduction, or convection within a fluid, and/or between a fluid and its surroundings.
Heat-transfer fluid	Either a liquid or a gas that absorbs heat and transfers it from the point of collection to storage or use. In this sense is used in solar-thermal systems to turn turbines.
Hertz	A frequency of one cycle per second.
Hypersonic	Equal or greater than five times the speed of sound.
Incident light	Light that directly strikes something.
Inflated	In this sense denotes a type of solar concentrator that is filled with air, and one of the inside surfaces, covered with some reflective material, focuses sunlight.

Insolation	The rate of solar radiation received by a unit surface area in unit time (W/m ² , Btu/hr. ft. ²).
Klystron	A valve in which the electron stream is modulated in velocity and the electrodes of the output circuit (and also possibly of the input circuit) are combined to form a resonant circuit of a special type known as a rhumbatron.
Langley	A unit of energy per unit area commonly employed in radiation theory; equal to 1 gram calorie per square centimeter.
Latent heat	The heat released or absorbed per unit mass by a system in a reversible change of phase at constant pressure and constant temperature
Mach	Denotes of or pertaining to the speed of sound (738 mph) and multiples thereof (i.e., Mach 2 is twice the speed of sound, etc.).
Magnetron	A thermionic valve, the electron path of which is controlled by a magnetic field.
Mass drive reaction engine	A device that uses electromagnetic forces to accelerate something to high velocities.
Megawatt	A million watts
Micron	One thousandth of a millimeter.
Microwave heating	The warming of something due to the action of microwaves.
Nanometer	One-billionth of a meter.

Parabolic	Of or like a parabola.
Parallel burn	Denotes simultaneous firing of rocket engines or motors.
Peak power density	Denotes the point within a beam of electromagnetic waves where the power is most intense per unit of area.
Photon	In the quantum theory of light, light consists of tiny bundles of energy. One of these bundles is a photon.
Photovoltaic	Photoelectric; denotes the power conversion process in which sunlight is directly transformed into electricity.
Photovoltaic cell	A cell that generates electrical energy when light falls on it.
Pilot beam	Denotes the beam of energy which will emanate from a receiving antenna to its power satellite and will be used as a point of reference to aim a microwave or laser beam.
Planar	Denotes a flat, level or even surface.
Power density	Refers to the amount of power contained within a given area of a beam of electromagnetic waves.
Power relay satellite	One conceptual satellite power system in which power is generated on earth and beamed to a geostationary satellite for relay to another point on earth.

Proof of principle	Testing that demonstrates that a particular principle or process works.
Pyranometer	An instrument for measuring total hemispherical solar (beam plus diffuse) radiation, usually on a horizontal surface.
Pyrheliometer	An instrument using a collimated detector for measuring solar radiation from a small portion of the sky including the sun (i.e., beam radiation at normal incidence).
Radiation, beam	That solar radiation received from the sun without change of direction.
Radiation damage	Damage produced by high energy particles that exist outside of the earth's atmosphere. Refers particularly to damage to photovoltaic cells or reflective surfaces.
Radiation, diffuse	That solar radiation received from the sun after its direction has been changed by reflection and scattering by the atmosphere.
Ramjet	A jet engine in which the air is continually compressed by being rammed into the open front end.
Rectenna	A coined term for a receiving antenna.
Reference system	The theoretical, projected satellite power system that has been devised for study purposes and is used as a yardstick for all calculations in the concept development and evaluation program.
Reflectivity	The ratio of radiant energy reflected by a body to that falling upon it.

Silicon	A non-metallic chemical element found always in combination and more abundant in nature than any other element except oxygen.
Societal assessment	A series of studies within the CDEP assessing the impacts of SPS on resources (land, material, and energy), institutions (government, utility, and financial), international aspects (agreements, organizations and military implications), and society (public acceptance and centralization issues) and vice versa.
Solar cell	Photovoltaic cell.
Solar cell array	A group of solar cells complete with supporting structure and wire interconnections.
Solar concentrator	Anything that focuses or intensifies sunlight by either refraction or reflection.
Solar constant	The rate at which solar radiation is received outside the earth's atmosphere, on a surface normal to the incident radiation, and at the earth's mean distance from the sun. The currently accepted value is 1373 W/m ² .
Solar radiation	The total electromagnetic radiation emitted by the sun.
Solar thermal	A solar conversion process that uses sunlight to warm a heat-transfer material which then is used directly for heating or for other purposes. In SPS refers to using sunlight to heat a material which then turns turbines, producing electricity, which is beamed to earth.
Sortie	A mission.
Space Shuttle	The first reusable space craft. First test flights are expected in late 1980 or early 1981.

Specific heat	(Also specific heat capacity). The heat capacity of a system per unit mass.
Speed of sound	738 miles per hour.
Staged combustion	Denotes something that burns sequentially. In SPS refers to rocket stages that burn one after another.
Subsonic	Slower than the speed of sound.
Substrate	A part, substance, or element which lies beneath and supports another.
Supersonic	Faster than the speed of sound.
Systems definition	A portion of the CDEP which progressively refines the SPS reference system in the context of new concepts and technologies.
Temperature	A measure of the degree of hotness or coldness of a substance.
Temperature coefficient, solar cell	The amount by which the voltage, current or power from a solar cell will vary with changes in the temperature of the cell.
Terrestrial	Of, consisting, or representing the earth.
Thermal-nuclear SPS	One SPS concept which calls for orbiting heat-generating nuclear power plants and converting the derived electricity for transmission to earth.
Thermometer	An instrument for measuring temperature, generally the temperature of the air in meteorology.

Thrust-to-weight ratio

A ratio of a propulsive device's thrust compared to its weight, and in the same terms

Turbojet

A jet engine in which the energy of the jet operates the air compressor.

Van Allen radiation belts

Two broad zones of intense, natural radiation encircling the earth at varying levels in the upper atmosphere.

Working fluid

A fluid, either liquid or gaseous, which transfers heat in a thermal-energy system. Also known as a heat-transfer-fluid.

Zenith

The point, on any given observer's celestial sphere, which lies directly over his head.

ATTENDEES LIST

MARVIN D. AASEN, Scientific Advisor
IIT Research Institute
Annapolis, Maryland 21404

MARTIN ABROMAVAGE
Argonne National Laboratory
400 North Capital Street, Suite 185
Washington, D. C. 20001

DR. E. J. AINSWORTH
74-25 Lawrence Berkeley Laboratory
Berkeley, California 94720

DR. JOHN W. ALLIS
EBD, Cellular Biophysics Branch (MD-74)
U. S. Environmental Protection Agency
Research Triangle Park, N. C. 27711

SAMUEL ALTMAN
Department of Communications
Communications Research Center
P. O. Box 11490, Station H
Ottawa, Ontario, Canada K2H852

ROMAN W. ANDRYCZYK
General Electric Company
P. O. Box 8555
Philadelphia, Pennsylvania 19101

SAM ANKERBRANDT
PRC Systems Services Company
Suite 2340
10960 Wilshire Boulevard
Los Angeles, California 90024

G. D. (DICKEY) ARNDT
NASA - Johnson Space Center
Mail Code EH2
Houston, Texas 77058

J. H. ATKINSON
DoD/ECAC
Annapolis, Maryland 21404

ROBERT U. AYRES
Carnegie-Mellon University
Pittsburgh, Pennsylvania 15213

ARRIE BACHRACH
Environmental Resources Group
6380 Wilshire Boulevard, Suite 804
Los Angeles, California 90048

SHLOMO BACHRACH
Environmental Resources Group
6380 Wilshire Boulevard, Suite 804
Los Angeles, California 90048

S. P. BATTISTA
Arthur D. Little, Inc.
25 Acorn Park
Cambridge, Massachusetts 02140

HAROLD BENSON
NASA - Johnson Space Center
Houston, Texas 70058

DR. EZRA BERMAN
EBD, Developmental Biology Branch (MD-72)
U. S. Environmental Protection Agency
Environmental Research Center
Research Triangle Park, N. C. 27711

P. A. BERNHARDT
Stanford University
Durand Building, Room 306
Stanford, California 94305

DR. JAN BEYEA
National Audubon Society
950 Third Avenue
New York, New York 10022

MARIONETTE BISHOP
The University of Alabama in Huntsville
Johnson Environmental and Energy Center
P. O. Box 1247
Huntsville, Alabama 35899

J. B. BLACKBURN
Rice University
3417 Montrose - #104
Houston, Texas 77006

ROBERT S. BLOCK
[University of Pennsylvania]
51 Johnson Street
Trumbull, Connecticut 06611

CHARLES BLOOMQUIST
PRC Systems Services Company
10960 Wilshire Boulevard, Suite 2340
Los Angeles, California 90024

KEN BOSSONG
Citizens' Energy Project
1110 Sixth Street, N.W. #300
Washington, D. C. 20001

PETER B. BOYCE
1816 Jefferson Place
Washington, D. C. 20036

ROBERT BRAMSCHER
6044 Eighth Avenue
Kenosha, Wisconsin 53140

L. WHITT BRANTLEY, JR.
NASA/MSFC - PD 14
Marshall Space Flight Ctr., AL 35812

PAUL BROWN
United Engineers and Constructors
30 South Seventeenth Street
Philadelphia, Pennsylvania 19101

WILLIAM C. BROWN
New Products Center, Building 12
Raytheon Company
Foundry Avenue
Waltham, Massachusetts 12154

JAMES R. BROWNELL, JR.
KAPPA Systems Incorporated
1501 North Wilson Boulevard
Arlington, Virginia 22209

RONALD BROWNSTEIN
Center for Study of Responsive Law
Box 19367
Washington, D. C. 20036

KENNETH L. BRUBAKER
Argonne National Laboratory
9700 South Cass Avenue, EES-12
Argonne, Illinois 69439

DAVID B. CAGLE
The University of Alabama in Huntsville
Johnson Environmental and Energy Center
P. O. Box 1247
Huntsville, Alabama 35899

DR. DANIEL F. CAHILL
Experimental Biology Division (MD-71)
U.S. Environmental Protection Agency
Environmental Research Center
Research Triangle Park, N. C. 27711

H. DONALD CALAHAN
Program Manager, SPS
NASA Headquarters
Code RES-1
Washington, D. C. 20546

DR. ALI B. CAMBEL, Director
Office of Energy Programs
George Washington University
725 23rd Street, N. W. - Room 210
Washington, D. C. 20052

HUGH CARMICHAEL
Aerospace Corporation
P. O. Box 92957, Bldg. D5, Room 2113
Los Angeles, California 90009

EUGENE A. CARTER
The University of Alabama in Huntsville
Johnson Environmental and Energy Center
P. O. Box 1247
Huntsville, Alabama 35899

C. H. CHAN
Physics Department
The University of Alabama in Huntsville
P. O. Box 1247
Huntsville, Alabama 35899

PHILIP K. CHAPMAN
Arthur D. Little, Inc.
Acorn Park
Cambridge, Massachusetts 02140

DR. Y. T. CHIU
Aerospace Corporation
P. O. Box 92957
Los Angeles, California 90009

DAVID L. CHRISTENSEN
The University of Alabama in Huntsville
Johnson Environmental and Energy Center
P. O. Box 1247
Huntsville, Alabama 35899

RANDALL CLAMONS
1620 North Park Avenue
Tucson, Arizona 85719

P. Q. COLLINS
Imperial College of Science and Technology
Department of Management Science
London SW 7 2 BX England

DAVID J. COOGAN
400 North Eighth Street West
Riverton, Wyoming 82501

DALE R. CORSON
615 Clark Hall
Cornell University
Ithaca, New York 14853

CLARKE COVINGTON
426 Bayou View
Seabrook, Texas 77586

DR. DAVID R. CRISWELL
University of California, San Diego
Code A-030
LaJolla, California 92093

STEVEN A. CURTIS
NASA/GSFC
Code 961
Greenbelt, Maryland 20771

ALAN P. DAURIO
PRC Systems Services Company
10960 Wilshire Boulevard, Suite 2340
Los Angeles, California 90024

LEONARD W. DAVID
PRC Energy Analysis Company
7600 Old Springhouse Road
McLean, Virginia 22102

HUBERT P. DAVIS
Eagle Engineering, Inc.
17629 El Camino Real, Suite 125
Houston, Texas 77058

DR. KARL C. DAVIS
Battelle-Pacific Northwest Laboratory
P. O. Box 999
Richland, Washington 99352

RICHARD DeBLASIO
1617 Cole Boulevard
Golden, Colorado 80401

R. H. DIETZ
NASA - Johnson Space Center
EE4
Houston, Texas 77058

F. J. DJUTH
Rice University
Houston, Texas 77006

JAMES S. DONNELLA II
Marsh & McLennan, Inc.
1100 Milam Building, Suite 4500
Houston, Texas 77002

JOHN J. DOUGHERTY
3412 Hillview Avenue
Palo Alto, California 94304

K. E. DREXLER, Consultant
518 Putnam Avenue - #9
Cambridge, Massachusetts 02139

DR. JAMES E. DRUMMOND
Power Conversion Technology, Inc.
11588 Sorrento Valley Road, Suite 18
San Diego, California 92121

ART DULA
3102 Beauchamp Street
Houston, Texas 77009

LEWIS DUNCAN
Los Alamos National Scientific Lab
MS 664
Los Alamos, New Mexico 87545

ALLEN DUPAS
CNRS
Paris, France

KEVIN K. DYBDAL
P. O. Box 303
St. Olaf College
Northfield, Minnesota 55057

RICHARD W. EARHART
Battelle Columbus Laboratory
505 King Avenue
Columbus, Ohio 43201

DR. JOHN EDDY
National Center for Atmospheric Research
P. O. Box 3000
Boulder, Colorado 80307

CHARLES H. ELDRED
NASA - Langley Research Center
MS 365
Hampton, Virginia 23665

JOHN J. ENGLISH
Argonne National Laboratory
9700 South Cass Avenue - EES-12
Argonne, Illinois 60439

CLARE FARLEY
1800 Century Park East
Los Angeles, California 90067

EDWARD R. FINCH, JR.
36 West 44th Street
New York, New York 10036

WOOLSEY FINNELL III
NASA/MSFC - PD 14
Marshall Space Flight Ctr., AL 35812

JOE FOREMAN
113 East Taylor Run Parkway
Alexandria, Virginia 22314

I. V. FRANKLIN
British Aerospace Dynamics Group
Bristol Division (FPC 78)
Bristol BS12 7Q UK

ROBERT FRAYSSE
European Space Agency
8-10 Rue Mano Nikis
F5015 Paris, France

DICK H. FREDERICKSEN
T. J. Watson Research Center
IBM
Yorktown Heights, New York 10598

DR. JOHN W. FREEMAN
Rice University
Houston, Texas 77001

DR. NORMAN E. GARY
Department of Entomology
University of California
Davis, California 95616

ROBERT GIUDICI
NASA/MSFC - PD 14
Marshall Space Flight Ctr., AL 35812

DR. PETER E. GLASER
Arthur D. Little, Inc.
20 Acorn Park
Cambridge, Massachusetts 02140

DR. ING. FRIEDRICH J. GLATZEL
c/o RWE AG ABT.AT
Postfach 27
4300 ESSEN 1/Germany

DR. RICHARD GRAN
Research Department, A08-35
Grumman Aerospace Corporation
Bethpage, New York 11714

WILLIAM B. GRANT
U. S. Department of Commerce, NTIA/ITS
325 Broadway
Boulder, Colorado 80303

H. STANLEY GREENBERG
Rockwell International
12214 Lakewood Boulevard
Downey, California 90241

H. BARBARA GUILLET
The University of Alabama in Huntsville
Johnson Environmental and Energy Center
P. O. Box 1247
Huntsville, Alabama 35899

KUAN-LIANG GUO
The University of Alabama in Huntsville
P. O. Box 1247
Huntsville, Alabama 35899

C. WILLIAM HAMILTON
Battelle Memorial Institute
2030 M Street, N. W.
Washington, D. C. 20036

G. M. HANLEY
Rockwell International
12214 Lakewood Boulevard
Downey, California 90241

ZIAUL HASAN
55 Gill Lane - Apt. 69
Iselin, New Jersey 08830

GEORGE A. HAZELRIGG, JR.
ECON, Inc.
900 State Road
Princeton, New Jersey 08540

DR. ROSS ALAN HENDERSON
Bristol Division
British Aerospace Dynamics Group
FPC 64 P. O. Box 5
Filton, Bristol, BS12 FQW

C. M. HENSON
L-5 News
1620 North Park Avenue
Tucson, Arizona 85719

H. K. HENSON
1620 North Park Avenue
Tucson, Arizona 85719

T. A. HEPPENHEIMER
11040 Blue Allium Avenue
Fountain Valley, California 92708

D. G. HERVEY
Brown & Root Development, Inc.
P. O. Box 2002
Houston, Texas 77001

DAVID HIGGINS
Calculon Corporation
P. O. Box 290
Germantown, Maryland 20767

ALAN R. HILDEBRAND
c/o RR #7
Fredericton, New Brunswick E3 B4X8

JOHN HILL
Environmental Resources Group
6380 Wilshire Boulevard, Suite 804
Los Angeles, California 90048

TAKAYUKI HIRANO
Japan Trade Center
1221 Avenue of the Americas
New York, New York 10020

RICHARD H. HOLZE
Boeing Aerospace Company
Box 3999
Seattle, Washington 98124

MARK M. HOPKINS
Rand Corporation
1700 Main Street
Santa Monica, California 90406

WILLIAM HOWARD
8720 Craig
Overland Park, Kansas 66212

W. M. JAMIESON
Battelle Columbus Laboratories
505 King Avenue
Columbus, Ohio 43201

ORLANDO E. JOHNSON
Boeing Aerospace Company
Mail Stop 84-83, P. O. Box 3999
Seattle, Washington 98124

ROSS M. JONES
Jet Propulsion Laboratory
4800 Oak Grove Drive
M.S. 277-102
Pasadena, California 91103

JER NAN JUANG
Jet Propulsion Laboratory
4800 Oak Grove Drive
Pasadena, California 91103

JOHN R. JUROSHEK
U. S. Department of Commerce, NTIA/ITS
325 Broadway
Boulder, Colorado 80303

JOSEPH KAPLAN
SRI International
33 Ravenswood Avenue
Menlo Park, California 94025

DIETER KASSING
European Space Research and Technology
Center
Postbus 299
2200 AG Noordwijk 2h
The Netherlands

BJORN KAUPANG
General Electric Company
1 River Road
Schenectady, New York 12345

PAUL KAVANAGH
13 Balsam Road
Toronto, Ontario, Canada

STEPHEN L. KLINEBERG
Department of Sociology
Rice University
Houston, Texas 77001

DR. DIETRICH E. KOELLE
Space Division
Messerschmitt-Bolkow-Blohm
Gesellschaft Mit Beschränkter Haftung
Unternehmensbereich Raumfahrt
POSTFACH 80 11 69 8000 Munchen 80

FREDERICK A. KOOMANOFF
SPS Project Office
U. S. Department of Energy
MS J-309
Washington, D. C. 20545

ALLAN D. KOTIN
Kotin & Regan, Inc.
10850 Wilshire Boulevard, Suite 560
Los Angeles, California 90024

K. R. KUBITZ
Pacific Gas & Electric Company
77 Beale Street
San Francisco, California 94106

ALAN LADWIG
FASST
1500 Massachusetts Avenue, N.W. #22
Washington, D. C. 20005

B. D. LaMAR
Argonne National Laboratory
9700 South Cass Avenue, EES-12
Argonne, Illinois 60439

CARL M. LANGDON
Advanced Solar Energy Technology
1609 West Windrose Drive
Phoenix, Arizona 85029

J. P. LAYTON
Consultant
60 Penn-Lyle Road
Princeton Junction, New Jersey 08550

JAMES LAZAR
Argonne National Laboratory
400 North Capital St., NW, Suite 185
Washington, D. C. 20001

CHARLES F. LEBEDA
EG & G, Inc.
P. O. Box 809
Los Alamos, New Mexico 87544

J. LEE
Argonne National Laboratory
9700 South Cass Avenue, EES-12
Argonne, Illinois 60439

MICHAEL LEONARD
L-5 Society of Lincoln
3344 T Street
Lincoln, Nebraska 68503

RAYMOND S. LEONARD
P.O. Box 931 - 1232 Date Street
Montara, California 94037

ROBERT H. LEWIS
6625 Clayton Avenue, Apt. 223
St. Louis, Missouri 63139

WILLIAM B. LEWIS
The Boeing Company
P. O. Box 58747
Houston, Texas 77058

HAROLD LIEMOHN
The Boeing Company
P. O. Box 3999
Seattle, Washington 98124

DOUGLAS S. LILLY, Program Manager
NASA Headquarters
Code RES-1
Washington, D. C. 20546

LOU LIVINGSTON
NASA - Johnson Space Center
Houston, Texas 70058

W. LLOYD
Marsh & McLennon, Inc.
1221 Avenue of the Americas
New York, New York 10020

JOHN M. LOGSDON
Graduate Program in Science Technology
and Public Policy
George Washington University
Washington, D. C. 20052

RALPH LOVBERG
Power Conversion Technology, Inc.
11588 Sorrento Valley Road, Suite 18
San Diego, California 92121

RICHARD H. LOVELY
Biology Department
Battelle-Pacific Northwest Laboratory
Richland, Washington 99352

AREL LUCAS
L-5 News
1620 North Park Avenue
Tucson, Arizona 85719

WALTER W. LUND, JR.
Senior Specialist Engineer
Boeing Aerospace Company
P. O. Box 3999
Seattle, Washington 98124

JOHN T. LYMAN
Lawrence Berkeley Laboratory
Berkeley, California 94720

WILLIAM E. MacDANIEL
Sociology Department
Niagara University
Niagara University, New York 14109

JOSEPH MacGREENE
3386 Oakman Boulevard
Detroit, Michigan 08238

ADELE KING MALONE
National Academy of Sciences
2101 Constitution Avenue
Washington, D. C. 20418

SIMON V. MANSON
SPS Program Manager
NASA Headquarters
Code RES-1
Washington, D. C. 20546

RONALD McCAFFREY
Grumman Aerospace Corporation
A09-25
Bethpage, New York 11714

DR. JAMES E. McCOY
NASA - Johnson Space Center
Code SN3
Houston, Texas 77058

ROSE McCULLOUGH
715 South Fourteenth Street
Lincoln, Nebraska 68508

SHERRY McNEAL
PRC Systems Service Company
10960 Wilshire Boulevard, Suite 2340
Los Angeles, California 90024

WILLIAM V. McRAE, JR.
Rockwell International
3322 South Memorial Parkway
Huntsville, Alabama 35804

GERALD MELTZ
United Technology Research Center
Silver Lane
East Hartford, Connecticut 06118

KEITH H. MILLER
Boeing Aerospace Company
P. O. Box 3999, Mail Stop 8R-72
Seattle, Washington 98124

WAYNE F. MILLER
Project Manager, Large Space Systems
Lockheed Space Systems Division
1111 Lockheed Way - Building 104
Sunnyvale, California 94088

ERNEST L. MORRISON
U. S. Department of Commerce
325 Broadway
Boulder, Colorado 80303

DAVID MURPHY
Technical Writer, DOE; L-5 Society
Route 2, Box 35-A
Carterville, Illinois 62918

D. S. NACHTWEY
NASA-Johnson Space Center
Houston, Texas 70058

ERVIN J. NALOS
Boeing Aerospace Company
P.O. Box 3999, Mail Stop 8C-62
Seattle, Washington 98124

RALPH H. NANSEN
Boeing Aerospace Company
P. O. Box 3999, Mail Stop 84-83
Seattle, Washington 98124

JAMES P. NAUGHTON
National Research Council
Commission on Natural Resources
Environmental Studies Board
2101 Constitution Avenue
Washington, D. C. 30418

MARKUS NOWOGRODZKI, Manager
Subsystems and Special Projects
RCA Laboratories
David Sarnoff Research Center
Princeton, New Jersey 08540

A. A. NUSSBERGER
Rockwell International
12214 Lakewood Boulevard
Downey, California 90241

KIRSTEN OLDENBURG
875 Broadway #4
San Francisco, California 94133

JOHN OLDSO
2808 Grant, #A
Berkeley, California 94703

RICHARD L. OLSON
Boeing Aerospace Company
P. O. Box 3999, Mail Stop 8R-72
Seattle, Washington 98124

FREDERICK H. OSBORN, JR.
Executive Secretary
SUNSAT Energy Council
P. O. Box 201
Cold Spring, New York 10516

JAMES OTT
Novar Electronics Corporation
24 Brown Street
Barberton, Ohio 44203

DR. VERNON PANKONIN
Division of Astronomical Sciences
National Science Foundation
1800 G Street, N.W.
Washington, D. C. 20550

E. PASSERINI
University of Alabama
Box CD
University, Alabama 35486

N. DOUGLAS PEWITT
U. S. Department of Energy
Washington, D. C. 20013

DR. DAVID PHELPS
Power Conversion Technology, Inc.
11588 Sorrento Valley Road, Suite 18
San Diego, California 92121

ROBERT O. PILAND
NASA - Johnson Space Center
Mail Code SA
Houston, Texas 77058

CHARLES POLK
21 Spring Hill Road
Kingston, Rhode Island 02881

MORRIS B. PONGRATZ
Group P-4, MS 664
Los Alamos Scientific Laboratory
P. O. Box 1663
Los Alamos, New Mexico 87545

JERRY E. POURNELLE
12051 Laurel Terrace
Studio City, California 91604

JAMES RABE
Environmental Resources Group
6380 Wilshire Boulevard, Suite 804
Los Angeles, California 90048

W. F. RECTOR
201 John Street
Manhattan Beach, California 90266

TONY REDDING
NASA - Johnson Space Center
Houston, Texas 70048

K. K. REINHARTZ
European Space Agency
Postbus 299
2200 AF Noorwijk 2h
The Netherlands

DR. JAMES S. RICE
Novar Electronics Corporation
24 Brown Street
Barberton, Ohio 44203

DON RICHARDS
Novar Electronics Corporation
24 Brown Street
Barberton, Ohio 44203

JOHN M. RICHARDSON
National Academy of Sciences
2101 Constitution Avenue, N.W. - JH 804
Washington, D. C. 20418

MICHAEL R. RICHES
SPS Project Office
U. S. Department of Energy
MS J-309
Washington, D. C. 20545

ROBERT C. RIED
800 Murphy Lane
Friendswood, Texas 77546

GUILLERMO RODRIGUEZ
Jet Propulsion Laboratory
4800 Oak Grove Drive
Pasadena, California 91103

LEE E. ROGERS
Ecological Sciences Department
Battelle - Pacific Northwest Laboratory
6652 I Building
Richland, Washington 99352

FRED ROSI
8903 Tolman Road
Richmond, Virginia 23229

DONALD M. ROTE
Argonne National Laboratory
9700 South Cass Avenue, EES-12
Argonne, Illinois 60439

DR. CHARLES M. RUSH
NTIA/ITS
Boulder, Colorado 80303

MICHAEL E. SAMSA
Argonne National Laboratory
9700 South Cass Avenue, EES-23
Argonne, Illinois 60439

CARL A. SANDAHL
Argonne National Laboratory
400 North Capital St., N.W., Suite 185
Washington, D. C. 20001

DR. STEPHEN SCHMELLING
Sierra Club
222 South Country Club Road
Ada, Oklahoma 64820

KLAUS SCHROEDER
2901 South Sepulveda Boulevard, #259
West Los Angeles, California 90064

MILTON A. SCHULTZ
P. O. Box 321
Marion, Iowa 52302

GEORGE SCHUSTER
Battelle-Pacific Northwest Laboratory
P. O. Box 999
Richland, Washington 99352

F. CARL SCHWENK, Manager
Space Utilization Systems
NASA Headquarters
Code RES-1
Washington, D. C. 20546

VALERIE SEAQUIST
The University of Alabama in Huntsville
Johnson Environmental and Energy Center
P. O. Box 1247
Huntsville, Alabama 35899

JACK W. SEYL
18219 Nassau Bay Drive
Houston, Texas 77058

RAEFE MICHAEL SHELTON
SPS Project Manager
British Aerospace Dynamics Group
Bristol Division
FPC78, PO Box 5 Filton
Bristol, BS 127QW UK

STEPHEN I. SHOTLAND
PRC Systems Services Company
10960 Wilshire Boulevard, Suite 2340
Los Angeles, California 90024

ROBERT SHOWEN
SRI International
333 Ravenswood Avenue
Menlo Park, California 94025

RAND SIMBERG
Aerospace Corporation
Building A-2, Room 2293
El Segundo, California 90245

DAVID SMITH
Massachusetts Institute of Technology
77 Massachusetts Avenue
Cambridge, Massachusetts 02139

MARCIA SMITH
SPRD, Congressional Research Service
10 First Street, S. E.
Washington, D. C. 20540

STEVE SMITH
Novar Electronics Corporation
24 Brown Street
Barberton, Ohio 44203

B. R. SPERBER
Boeing Aerospace Company
P. O. Box 3999, Mail Stop 8R-72
Seattle, Washington 98124

BERNARD STEIN
6727 Rosewood Street
Annandale, Virginia 22003

DONALD L. STEVENSON
Senior Marketing Representative
DuPont Company
18121 NE 196th Street
Woodinville, Washington 98072

HEINZ STOEWER
European Space Agency
Postbus 299
2200 AG Noordwijk 2h
The Netherlands

MICHAEL JON STOIL
KAPPA Systems, Incorporated
1501 Wilson Boulevard
Arlington, Virginia 22209

KENNETH C. SUN
1050 Crestview Drive
Mountain View, California 94040

PROFESSOR ROMUALDAS SVIEDRYS
Polytechnic Institute of New York
333 Jay Street
Brooklyn, New York 11201

ROBERT TAUSSIG
Mathematical Sciences Northwest Inc.
P. O. Box 1887
Bellevue, Washington 98009

THOMAS C. TAYLOR
15440 Sherman Way #4230
Van Nuys, California 91406

RONALD R. TEETER
Battelle - Columbus Laboratory
505 King Avenue
Columbus, Ohio 43201

PAUL TETU
Paul Tetu Products
200 Park Avenue, Suite 303E
New York, New York 10017

A. R. THOMPSON
National Radio Astronomy Observatory
P. O. Box 0
Socorro, New Mexico 87801

LEE TORREY
Scorton Press
East Sandwich, Massachusetts 02537

J. P. VAJK
Science Applications, Inc.
1811 Santa Rita Road - Suite 104
Pleasanton, California 94566

A. R. VALENTINO
Argonne National Laboratory
9700 South Cass Avenue, EES-12
Argonne, Illinois 60439

JANICE VOSS
Massachusetts Institute of Technology
77 Massachusetts Avenue
Cambridge, Massachusetts 02139

WILLIAM W. WALES
3156 Winchester Road
New Market, Alabama 35761

S. J. WANG
Jet Propulsion Laboratory
4800 Oak Grove Drive
Pasadena, California 91103

DAVID G. WEIR
RCA Laboratories
Princeton, New Jersey 08540

SUE B. WEIR
The University of Alabama in Huntsville
Johnson Environmental and Energy Center
P. O. Box 1247
Huntsville, Alabama 35899

STEFI WEISBURD
Assistant Project Director
Office of Technology Assessment
U. S. Congress
Washington, D. C. 20510

DR. BECKY BROWN WESTERDAHL
Department of Entomology
University of California
Davis, California 95616

MARGARET R. WHITE
Lawrence Berkeley Laboratory
Building 29
University of California
Davis, California 94720

RONALD G. WHITFIELD
Argonne National Laboratory
9700 South Cass Avenue, EES-12
Argonne, Illinois 60439

R. C. WHITTEN
NASA - Ames Research Center
Mail Stop 245-3
Moffett Field, California 94035

J. R. WILLIAMS
Associate Dean of Engineering
Georgia Institute of Technology
Atlanta, Georgia 30360

DR. RAY A. WILLIAMSON
Office of Technology Assessment
U. S. Congress
Washington, D. C. 20510

WILLIAM WILSON
Teknekron Research, Inc.
1483 Chain Bridge Road
McLean, Virginia 22101

SIMA MILUSCHEWA WINKLER
Grumman Aerospace Corporation
Bethpage, New York 11743

JOST WISCHEROPP
Stellbrinkstr 22155
2400 Lubeck
Germany - West

THOMAS D. WOLSKO
Argonne National Laboratory
9700 South Cass Avenue, EES-12
Argonne, Illinois 60439

DR. RICHARD WOOD
Department of Aeronautics
Central Washington University
204 Peterson
Ellensburg, Washington 98926

DANIEL WOODARD
420 Market Street
Galveston, Texas 77550

GORDON R. WOODCOCK
Boeing Aerospace Company
P. O. Box 3999, Mail Stop 8R-72
Seattle, Washington 98124

ROBERT YOUNGBERG
2955 Stratford
Lincoln, Nebraska 68502

EDWARD ZIEGLER
United Engineers
30 South Seventeenth Street
Philadelphia, Pennsylvania 19101

JOHN ZINN
Los Alamos Scientific Laboratory
P. O. Box 1663, MS664
Los Alamos, New Mexico 87545