



NRL/FR/7650--09-10,179

Space-based Solar Power: Possible Defense Applications and Opportunities for NRL Contributions

W. NEIL JOHNSON

*High-energy Space Environment Branch
Space Science Division*

KEITH AKINS, JAMES ARMSTRONG, KWOK CHEUNG, GLEN HENSHAW, STEVEN HUYNH, PAUL JAFFE, GEORGE KIRBY, MATTHEW LONG, MICHAEL MOOK, MICHAEL NURNBERGER, MICHAEL OSBORN, ROBERT SKALITZKY, AND FREDERICK TASKER

Spacecraft Engineering Department

JILL DAHLBURG AND MICHAEL N. LOVELETTE

Space Science Division

ROBERT BARTOLO AND KEITH WILLIAMS

Optical Sciences Division

MARK DORSEY

Radar Division

DONALD GUBSER

Materials Science and Technology Division

PHILIP JENKINS, FRITZ KUB, BARUCH LEVUSH, SCOTT MESSENGER, JOHN PASOUR, AND ROBERT WALTERS

Electronics Science and Technology Division

NATHAN SMITH

Information Technology Division

WAYNE BONCYK

Design Net Engineering LLC, Golden, Colorado

MICHAEL BROWN

Praxis Inc., Alexandria, Virginia

DAVID HUBER

Research Support Instruments, Monmouth Junction, New Jersey

October 23, 2009

REPORT DOCUMENTATION PAGE

Form Approved
OMB No. 0704-0188

Public reporting burden for this collection of information is estimated to average 1 hour per response, including the time for reviewing instructions, searching existing data sources, gathering and maintaining the data needed, and completing and reviewing this collection of information. Send comments regarding this burden estimate or any other aspect of this collection of information, including suggestions for reducing this burden to Department of Defense, Washington Headquarters Services, Directorate for Information Operations and Reports (0704-0188), 1215 Jefferson Davis Highway, Suite 1204, Arlington, VA 22202-4302. Respondents should be aware that notwithstanding any other provision of law, no person shall be subject to any penalty for failing to comply with a collection of information if it does not display a currently valid OMB control number. **PLEASE DO NOT RETURN YOUR FORM TO THE ABOVE ADDRESS.**

1. REPORT DATE (DD-MM-YYYY) 23-10-2009		2. REPORT TYPE Formal Report		3. DATES COVERED (From - To)	
4. TITLE AND SUBTITLE Space-based Solar Power: Possible Defense Applications and Opportunities for NRL Contribution				5a. CONTRACT NUMBER	
				5b. GRANT NUMBER	
				5c. PROGRAM ELEMENT NUMBER	
6. AUTHOR(S) W. N. Johnson, K. Akins, J. Armstrong, K. Cheung, G. Henshaw, S. Huynh, P. Jaffe, G. Kirby, F. Kub, B. Levush, M. Long, M. Mook, M. Nurnberger, M. Osborn, R. Skalitzky, F. Tasker, J. Dahlburg, M.N. Lovelette, R. Bartolo, K. Williams, M. Dorsey, D. Gubser, P. Jenkins, S. Messenger, J. Pasour, R. Walters, N. Smith, W. Boncyk,* M. Brown,** and D. Huber***				5d. PROJECT NUMBER	
				5e. TASK NUMBER	
				5f. WORK UNIT NUMBER 76-8762-09-5	
7. PERFORMING ORGANIZATION NAME(S) AND ADDRESS(ES) Naval Research Laboratory 4555 Overlook Ave., SW Washington, DC 20375-5320				8. PERFORMING ORGANIZATION REPORT NUMBER NRL/FR/7650--09-10,179	
9. SPONSORING / MONITORING AGENCY NAME(S) AND ADDRESS(ES) Office of Naval Research One Liberty Center 875 North Randolph Street Arlington, VA 22203-1995				10. SPONSOR / MONITOR'S ACRONYM(S) ONR	
				11. SPONSOR / MONITOR'S REPORT NUMBER(S)	
12. DISTRIBUTION / AVAILABILITY STATEMENT Approved for public release; distribution is unlimited.					
13. SUPPLEMENTARY NOTES * Design Net Engineering LLC, Golden, CO ** Praxis Inc., Alexandria, VA ***Research Support Instruments, Monmouth Junction, NJ					
14. ABSTRACT The principal objective of this Naval Research Laboratory (NRL) SBSP study was to determine if NRL can offer a unique, cost-effective, and efficient approach to supplying significant power on demand for Navy, Marine Corps, or other Department of Defense applications by employing a space-based solar power system. This study was initiated by and prepared for top NRL management in part as result of the publication of the National Security Space Office's (NSSO) report "Space-Based Solar Power as an Opportunity for Strategic Security." This report reviews some of the critical technology issues for SBSP and highlights relevant research areas, particularly those that NRL is technically qualified to address. It must be noted that the principal objective of this study differs significantly from the multitude of previous studies performed in reference to SBSP in that it focuses on defense rather than utility grid applications. A secondary objective was to determine possible funding agencies that would entertain a broad NRL proposal to perform research and development for elements of such a system.					
15. SUBJECT TERMS Space-based solar power Photovoltaic power collection Wireless energy transmission Space structures Space solar power Solar power satellites Wireless power Military applications Satellite technology					
16. SECURITY CLASSIFICATION OF:			17. LIMITATION OF ABSTRACT SAR	18. NUMBER OF PAGES 103	19a. NAME OF RESPONSIBLE PERSON W.N. Johnson
a. REPORT Unclassified	b. ABSTRACT Unclassified	c. THIS PAGE Unclassified			19b. TELEPHONE NUMBER (include area code) (202) 767-6817

CONTENTS

1. INTRODUCTION.....	1
1.1 Summary Findings.....	1
2. MILITARY OPERATIONS SCENARIOS.....	2
2.1 Forward Operating Base Power.....	4
2.2 Power to Individual End Users.....	5
2.3 Power for Distributed Sensor Networks.....	6
2.4 Bistatic Radar Illuminator.....	7
2.5 Provide Power to a Remote Location for Synthfuel Production.....	7
2.6 Provide Power to a Ship or Large Seaborne Platform.....	8
2.7 Space Solar Power to Non-Terrestrial Targets.....	8
2.8 Terrestrial Wireless Power Beaming Applications Apart from SBSP.....	9
3. CONCEPT TECHNICAL FEASIBILITY ASSESSMENT.....	10
3.1 Some Proposed System Architectures.....	11
3.2 Power Collection.....	15
3.3 Wireless Power Transfer.....	17
3.4 Collection, Conversion, and Reception Technologies.....	22
4. RELEVANT RESEARCH AREAS.....	45
4.1 DC-to-RF Conversion.....	45
4.2 Microwave Power Beaming.....	45
4.3 Satellite Propulsion.....	48
4.4 Advanced Thermal Management Architecture.....	58
4.5 Thermal Analysis.....	60
4.6 Space Structure Technologies.....	66
4.7 Space Robotics Technologies.....	68
4.8 Structural Analysis of Transmit Array, Solar Collection, and Concentration Structures.....	69
4.9 Attitude Control.....	70
4.10 Orbital Dynamics: Atmospheric Drag.....	70
4.11 Distributed Energy Collection and Management for Space Elements.....	70
4.12 Other Areas of Research.....	71

5. DEMONSTRATION CONCEPTS	72
5.1 Microwave Power Beaming from the International Space Station	72
5.2 Earth to LEO Wireless Power Beaming	72
5.3 An International Collaboration LEO Free-Flyer Demonstrator Hosting One or More SBSP Technology Demonstrations and Experiments	72
5.4 Demonstrations Employing High Altitude Vehicles	74
5.5 Ground-Based Demonstration of Robotic Assembly of Space Structures.....	74
5.6 A Very Large Structure Robotic Construction Demonstration in Space	75
5.7 Laser or Microwave Terrestrial Power Beaming Demonstrations.....	75
 6. POSSIBLE FUNDING AGENCIES	 76
 7. RECOMMENDED NEXT STEPS.....	 77
 REFERENCES	 78
 APPENDIX A – Selected Study Activities	 87
 APPENDIX B – Contributors.....	 89
 APPENDIX C – Notes on Microwave Transmission Efficiencies	 91
 APPENDIX D – NRL Space History	 101

SPACE-BASED SOLAR POWER: POSSIBLE DEFENSE APPLICATIONS AND OPPORTUNITIES FOR NRL CONTRIBUTION – FINAL REPORT

1. INTRODUCTION

Space-based solar power (SBSP) is generally considered to be the collection in space of energy from the Sun and its wireless transmission from space for use on Earth. It has been observed that the implementation of such a system could offer energy security, environmental, and technological advantages to those who would undertake its development.

The principal objective of this Naval Research Laboratory (NRL) SBSP study was to determine if the NRL can offer a unique, cost-effective, and efficient approach to supplying significant power on demand for Navy, Marine Corps, or other Department of Defense (DoD) applications by employing a space-based solar power system. This study was initiated by and prepared for top NRL management in part as a result of the publication of the National Security Space Office's (NSSO) report "Space-Based Solar Power as an Opportunity for Strategic Security."

The NSSO report's recommendations included statements calling for the U.S. Government to conduct analyses, retire technical risk, and become an early demonstrator for SBSP. As the corporate research laboratory for the Navy and Marine Corps with a proven record of technology transition, NRL is ideally suited to assist in this effort. NRL's in-house capabilities include an integrated spacecraft design, fabrication, and qualification facility, and a ground station network.

This report reviews some of the critical technology issues for SBSP and highlights relevant research areas, particularly those that NRL is technically qualified to address. It must be noted that the principal objective of this study differs significantly from that of the multitude of previous studies performed in reference to SBSP in that it focuses on defense rather than utility grid applications.

A secondary objective was to determine possible funding agencies that would entertain a broad NRL proposal to perform research and development for elements of such a system.

1.1 Summary Findings

1.1.1 Concept Feasibility

- The NRL SBSP Study Group concurs with the conclusions of the numerous previous studies of preceding decades that the SBSP concept is technically feasible but that there remain significant system risks in many areas.
- The Group concurs that SBSP offers one of several possible solutions to the energy independence and dominance of our country and our military; and that those alternative solutions (including terrestrial solar, nuclear, and wind) must be an integral part of the solution.
- Safe power densities for wireless energy transmission generally restrict applications to large, relatively immobile receiver sites.
- Capital, launch, and maintenance costs remain significant concerns in the economics of fielding a practical SBSP system, an analysis of which was beyond the scope of this study.

1.1.2 Military Operations Scenarios

- SBSP systems employing microwave power transmission at frequencies below 10 GHz are most suited for a limited number of bases and installations where the large area required for efficient power reception would be available.
- For applications requiring smaller apertures, either millimeter wave or laser power transmission may be preferable, although tradeoffs among safety, increased atmospheric attenuation, and received power density must be addressed carefully.
- Direct power transmission to individual end users, vehicles, or very small, widely scattered nodes does not currently appear practical, primarily because of the large inefficiencies and the possible risks of providing what amounts to a “natural resource.”
- Backup alternatives should be considered for installations in the event of failure, compromise, or military action, as an SBSP system may present the problem of a single point of failure.

1.1.3 Relevant Research Areas

- NRL has world class competencies in many of the engineering core areas necessary for SBSP risk reduction: thermal management, space structures, space robotic assembly, photovoltaics, RF amplifier technology, energy storage and management, propulsion, and spacecraft and system engineering.
- Research applied to the areas in which NRL has core competencies would yield substantial technological dividends for SBSP as well as other space and terrestrial applications.
- NRL’s Naval Center for Space Technology (NCST) offers a unique and credible facility for developing and deploying spaceborne SBSP demonstrators. NCST has previously flown many experimental integrated systems and technology demonstration missions, including many cutting-edge solar power generation experiments.

1.1.4 Recommended Course Forward

- Members of the NRL SBSP Study Group, in collaboration with all NRL interested scientists, should:
 - Proceed to maintain meaningful and continuing engagement with the wider SBSP community and its efforts, both nationally and internationally.
 - Pursue sponsors to mount compelling demonstrations related to space-based solar power, with continued attention to military-specific opportunities.
- NRL leadership should consider continuing and expanding funding for energy technologies (such as generation, transmission, and storage) including, as appropriate, funding for SBSP component technologies and experimentation.

This study concludes that SBSP concepts and technologies are inherently viable, require further development, and are integral to many national security applications for energy independence and military superiority. Compelling research and collaboration opportunities exists for qualified organizations like NRL. Leadership needs to focus these efforts to construct a SBSP capability with true benefit and value.

2. MILITARY OPERATIONS SCENARIOS

These scenarios take as a basic premise that energy from solar flux will be collected in space and beamed wirelessly for use in a defense context. Many of the scenarios addressed have been posited in

previous SBSP discussions and literature. Some were discussed during the Air Force Research Laboratory (AFRL) sponsored Military Power Requirements Symposium that was held on the July 1 and 2, 2008. Table 1 is a summary of the results of the SBSP investigation.

In nearly all military scenarios (Table 1), space-based solar power must not become a source of “single point failure.” It has been observed that in the event that satellite communications become unavailable from some reason, there typically exists a backup means, such as HF communications.

Table 1 – Investigation Summary

Military Operations Scenario	Rationale for SBSP	Feasibility		Notes	Earliest operational capability	Rough magnitude cost
		Technical	Economic			
Forward Operating Base Power	Reduce fuel convoys	Possible	Possible	Probably best SBSP defense app	>5 years	\$10B+
Provide power to a ship or other large seaborne platform	Refuel from space	Possible	Possible	Almost certainly requires lasers and high power densities	>5 years	\$10B+
Bistatic radar illuminator	Improve imaging	Possible	Possible	Feasible but expensive	>5 years	\$10B+
Provide power to a remote location for synthfuel production	Reduce infrastructure	Possible	Possible	Requires transportation architecture that consumes synthfuel	>5 years	\$10B+
Power to Individual End Users	Reduce battery mass	Unlikely	Unlikely	Power inefficient, severe beam control, and safety challenges	>10 years	?
Power for Distributed Sensor Networks	Cover large area	Possible	Unlikely	Power inefficient	>5 years	\$10B+
Space solar power to non-terrestrial targets						
Satellite to satellite power transmission	Fractionate spacecraft	Possible	Possible	Significant technical issues, questionable utility	>2 years	\$50M+
Space to UAV for dwell extension	Prolong dwell times	Possible	Possible*	*if used in conjunction with FOB power	>5 years	\$10B+
Terrestrial Wireless Power Beaming Applications Apart from SBSP						
Ship to shore power beaming	Increase flexibility	Possible	Possible	Attractive defense application, requires more study	>1 year	\$10M+
Ground to UAV for dwell extension	Prolong dwell times	Demonstrated	Possible	May be unnecessary in light of recent UAV tech advances	>1 year	\$10M+

2.1 Forward Operating Base Power

A Forward Operating Base (FOB) exists to support a small number of reconnaissance and surveillance teams as well as for military power projection ahead of primary forces. As such, the FOB can be anywhere from 50 to 5000 personnel because it is task-organized and scales to meet the size of the assigned task(s).

Provision of electrical energy to the FOB must be viewed as a necessary commodity. The FOBs tend to be in remote, relatively inaccessible areas, due to both terrain and location of opposing forces (OPFOR). Resupply missions are tradeoffs between the risk of sending in an armed convoy and the risk, and substantial additional costs, of air resupply.

With basic assumptions of 1 to 3 kW/person at the FOB, generator usage can grow rapidly. An appropriate example is the mobile Command and Control center known as the Unit Operations Center (UOC) – the generator provided is 20 kW and consumes approximately half of a small trailer (the other half is occupied by an 8-ton environmental control unit and tent). The UOC is appropriately sized for use in an FOB and yet provides power only for itself. One innovative option is to have battlefield vehicles provide power for temporary operations – a concept demonstrated by the Reconnaissance, Surveillance, and Targeting Vehicle (RST-V) – which was capable of providing 30 kW of prime power to external systems. While 30 kW may be adequate for temporarily powering the UOC, as was suggested by the prime vendor, it is inadequate for any larger installation.

Currently, we use sets of semipermanent generators, set some distance away from the Command Operations Center (COC) in order to provide both thermal and noise abatement. Fuel and ammunition (designated the Forward Ammunition and Refueling Point or FARP) are likewise separated from the COC and living spaces for safety reasons.

Could SBSP credibly provide power to the FOB? Any replacement for the generators would have to meet similar safety and density provisions to those currently in operation. One of the advantages of using liquid fuel is that it is relatively dense for the energy provided. The generators are relatively small and portable (towable) and usage is well understood. Many SBSP proposals limit power density to the equivalency of one Sun at ground level. This implies that for a FOB of 500 persons (medium task size, no air strip) we need 500 m² of antenna, energy conversion, and short-term storage equipment, and support systems to provide ~200 kW of power. Support would include the necessary security perimeter. Efficient microwave power transfer to such a small area would be challenging. Instead, much of the surrounding countryside would likely also benefit from the power transfer, OPFOR included.

The size of the base in question is a critical factor. For microwave power reception from an SBSP satellite in space for sizable power provision while maintaining safe power densities, a contiguous elliptical area on the order of square kilometers will likely be required. This may limit applicability to infrastructure supporting tactical operations. Depending on the area and resources available for setting up a receiving array, forward bases, larger command posts, and supply depots may or may not be supportable with SBSP.

A point that needs to be clarified is the ultimate purpose of the power delivery. Will it provide utility grid service for an installation or is it for another purpose? Is it necessary to charge an energy storage device such as a battery or might it be stored as generated fuel? If energy cannot be directly delivered to its final application, either the application must be changed or it must be stored for later delivery by another method. Some possible contexts:

- Stationary facilities with large amounts of available real-estate – provide large amounts of continuous power to larger facilities. This scenario starts to look and feel like the power grid-type application that is typically posed for SBSP.

- Direct delivery to a power storage/conversion facility – charge batteries or convert into other energy-storage paradigms (e.g., fuels and stored mechanical potential energy).

Either contextual application is more suitable for a fairly secure area, relatively far away from any action. While potentially extremely useful to the personnel in action, the implementation is very different, and would seem to stretch the definition of “tactical.”

Millimeter-wave or laser delivery systems offer possible advantages, as the decrease in wavelength allows either (or both) apertures (transmit and receive) to be made smaller. Disadvantages include that power generation is less efficient, perhaps by as much as half, and propagation effects become important. Atmospheric absorption cuts delivered power perhaps by half again, and weather effects such as rain can introduce many dB of attenuation.

The forward base application of SBSP becomes more credible when it is applied to larger facilities, where it begins to approximate a special case of the utility grid application. Army fuel consumption data (Table 2) show that during field activity, electrical generators consume the largest fraction of delivered fuel, nearly 35% [1]. However, without a major shift in DoD transportation architecture to synthetic fuels, it may be of little help in fuel convoy reduction because of the large amount of aircraft and vehicle fuel required by such installations.

Table 2 – Army Fuel Consumption in Peacetime and Wartime (Million Gallons per Year) [1]

Category	Peacetime OPTEMPO*	Wartime OPTEMPO
Combat vehicles	30	162
Combat aircraft	140	307
Tactical vehicles	44	173
Generators	26	357
Non-tactical	51	51
TOTAL	291	1050

*Operations tempo – rate of usage

2.2 Power to Individual End Users

The prospect of reducing the need for soldiers and other users to carry numerous and heavy batteries is very attractive. Batteries are logistically challenging for their mass and for the need to protect them from moisture, extreme temperatures, and other hazards. It is estimated that 15% to 20% of a soldier’s 30 to 40 kg pack consists of batteries [1]. Obtaining replacement batteries adds to the fuel consumed by resupply lines, and the task of recharging batteries adds to the load on generators at forward bases. Because of this, SBSP has been posed as a means to recharge such batteries or to displace the need for them by providing power directly to the soldier.

Direct SBSP power delivery to daily patrols, either individuals or vehicles, seems problematic at best. In considering this, note that at microwave frequencies of 1.5 to 15 GHz, safe power densities for continuous exposure are between 1 and 10 mW /cm², or about 1 to 10 W per sq ft., respectively (IEEE C95.1-1999). The FCC (Bulletin 65) limits this exposure more, to a constant 1 mW /cm² (about 1 W per sq ft) above 1.5 GHz.

Examples of end-user consumption include the following:

- Radio transmitters: Considerable power needs to be available, for example, to operate a radio – tens to hundreds of Watts while transmitting.
- Vehicle operation: A typical car only requires tens of horsepower to travel at reasonable speeds on a highway (much more when accelerating or traversing rough terrain). 1 HP is approximately 750 W, so even a 10 or 20 HP requirement becomes a requirement for 7.5 to 15 kW of power, even before considering the conversion efficiency between electrical and mechanical energy.

The preferred application of power to these problems would require the ability to directly beam energy to each recipient rather than blanketing the area for several reasons:

- Only the people/vehicles need the power – a tremendous fraction of power is wasted if it is transmitted everywhere.
- Transmitting power everywhere is like providing a natural resource – one’s enemies can also use it (for free!), greatly reducing the advantage one gains by developing and implementing the system (at great cost).

At radio frequency (RF) frequencies, it is (probably impossible, but optimistically speaking) extraordinarily difficult to directly point beams small enough to solve the efficiency problem from space. Extraordinarily large antenna apertures would likely be required at microwave frequencies. Perhaps even more difficult would be how to tell the power source exactly where to point the beams (potentially several thousand of them, all to a delivered accuracy of 1 m or less). To further compound the problem, if the beam pointing challenges were solved, power density issues would need to be resolved – that is, if there was enough power in the beam to do any good, it would likely pose a safety hazard to the people in or near the beam.

Based on these statements, direct delivery of energy using microwave power to a final application to small, mobile units is not practically feasible with near-term foreseeable technology.

2.3 Power for Distributed Sensor Networks

Wireless Distributed Sensor Networks (WDSN) can be used to perform a variety of surveillance functions with both military and civilian applicability. One of the single largest limitations to their application is the availability of reliable power sources in remote locations. Traditionally, WDSN systems deployed in remote areas have used battery power, with the associated limited system lifetime, or have derived power from local sources (solar power via local arrays) that are not predictably reliable. Typical total energy requirements for WDSN networks are low, on the order of tens of Watt-hours per day or less, and the delivery of that level of power to small, field deployable rectennas with cross-sectional areas on the order of a square meter is well within the capability of even the smallest envisioned SBSP operating within the unrestricted safe power density of 10 W/m². The ability to charge buried or otherwise concealed sensors in this way is attractive. Additionally, the coherent RF downlinked to a sensor node in the network might be used to facilitate autolocation of nodes that are field relocatable.

A practical challenge for powering a distributed sensor network is that it is not currently possible to direct power solely to the sensors. In all likelihood for SBSP, a large area would need to be illuminated, resulting in only a tiny sliver of the downlinked power being used. It might be possible to periodically charge the sensors in a given area, but even in this case, the downlinked energy would essentially be a “natural resource” exploitable by anyone with suitable receiving equipment who was aware of its presence. Alternately, such sensors might be periodically recharged by UAVs or other more proximate providers of microwave energy to be rectified by the sensor.

2.4 Bistatic Radar Illuminator

Bistatic radar systems are generally well-suited to several specific applications where they outperform conventional monostatic radars, especially in real-world tactical scenarios. Notably, bistatic radars are of particular value in countering anti-radiation missile (ARM) threats, retro-directive radar jammers, and stealth radar technologies. They are inherently capable of implementing some processes, notably clutter-tuning, that are impossible for monostatic radars [2]. Any SBSP satellite delivering RF energy to the surface can be used in a “hitchhiker” configuration, where the same RF downlink used to provide power to ground users can also be used as a coherent source of that RF energy for bistatic radar implementations.

SBSP satellites used as RF sources for bistatic radar applications possess advantages over and above those afforded by more traditional satellites (e.g., GEO communication satellites, and GPS). Initially, SBSP bistatic systems will be able to operate at much higher effective isotropic radiated power (EIRP) than other spaceborne sources, providing orders of magnitude higher illumination of the surface, resulting in much higher signal to noise ratio (SNR), which allows detection of targets with much lower radar cross sections and minimizes an already lower threat from surface jammers. Instead of relying on coincidental illumination from more traditional spaceborne sources, SBSP RF illumination can be directed to specific tactical areas of interest, providing an “on-demand” capability as an adjunct to the SBSP’s primary power transmission mission.

2.5 Provide Power to a Remote Location for Synthfuel Production

One proposed innovation is to leverage power produced by an SBSP system to produce the fuel for a FOB or a larger installation via a cracking or synthesis process. As can be seen in Fig. 1, liquid fuels comprise a massive share of the DoD’s total energy consumption.

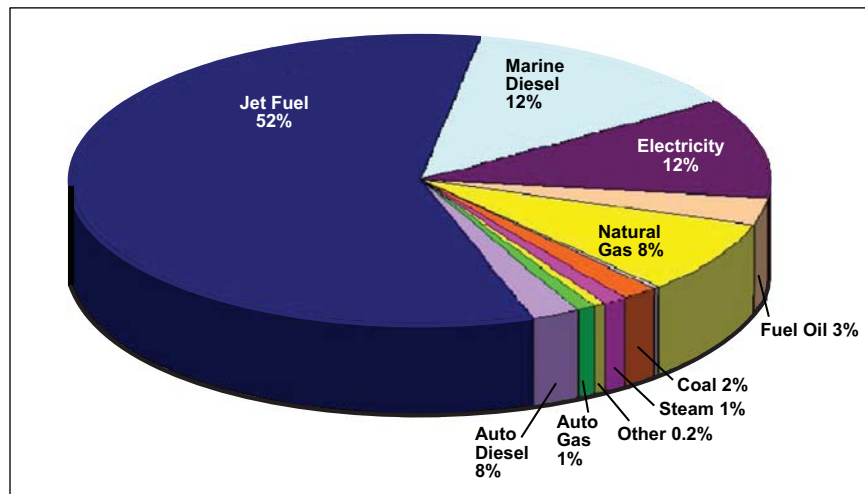

Fig. 1 – DoD energy consumption by type of fuel [1]

Two distinct classes of synthetic fuels exist today. The first, molecular hydrogen, can be produced directly from water via electrolysis. That electrolysis may result directly in hydrogen fuel, or it may be the first step in the synthesis of more complex hydrocarbon fuels. While molecular hydrogen can be used directly as a fuel, storage and transportation of hydrogen is still non-trivial and engines designed for use with traditional hydrocarbon (petroleum-based) fuels require extensive modifications to be usable with molecular hydrogen. Hydrocarbon-based, compatible synthfuels can be synthesized from sources of molecular hydrogen and carbon monoxide in the presence of a catalyst at environmental temperatures

between 150° and 300 °C. Recently NRL researchers Dennis Hardy and Timothy Coffey were awarded a patent for this concept (Process and System for Producing Synthetic Liquid Hydrocarbon Fuels, U.S. 7,420,004B2). In theory, any source of energy sufficient to support the electrolysis of water and subsequent conversion reactions to larger hydrocarbon molecules may be used for synthfuel production. Unfortunately, the amounts of energy required to synthesize significant quantities of synthfuel are themselves significant. This suggests that any production facility using SBSP for synthfuel manufacturing would need to employ large rectenna arrays – comparable in scope to those envisioned for terrestrial utility-grid applications of SBSP, i.e., in the 100 MW and up class. This likely limits the applicability of SBSP for synthfuel production to fixed-base facilities.

Mobile production of synthfuels may be possible for an oceangoing vessel, but the power required is considerable. As a point of comparison, a Nimitz-class aircraft carrier’s nuclear reactors produce about 100 MW. To use SBSP, once again, a large rectenna array would be required.

2.6 Provide Power to a Ship or Large Seaborne Platform

This application offers the possibility of allowing ships to stay at sea as long as their provisions hold out, much as is the case with nuclear submarines. A scheme to send SBSP power to a ship would almost certainly need to employ laser power beaming and would likely require power densities above current safety levels.

2.7 Space Solar Power to Non-Terrestrial Targets

SBSP, transmitted as RF energy from a solar power satellite in GEO, can be used to supplement or even supplant the more traditional sources of electric power on other satellites or unmanned aerial vehicles (UAVs). Restrictions on the downlink power density driven by bio-exposure constraints at the Earth’s surface would not necessarily apply to power beamed to other spacecraft, allowing smaller rectenna arrays to substitute for much larger and more massive solar array assemblies on the receiving vehicles. Power could be nearly continuous from a constellation of GEO SBSP satellites, which could minimize the disruption in operations of LEO vehicles or UAVs from lack of insolation during local night.

Alternatively, power from SBSP could instead be converted to light and beamed directly onto solar array assemblies on existing spacecraft, augmenting the amount of energy that they harvest from Sun exposure alone, providing potentially significant augmentation of the capabilities of those existing systems.

A further possibility is for laser or greater-than 10 GHz wireless power beaming to be sent to a very high altitude relay craft for conversion to less than 10 GHz for transmission through the atmosphere. The apertures for the atmospheric leg could be smaller than for a GEO system because of the greatly reduced range, but there would be additional inefficiencies in passing through the relay.

2.7.1 Satellite-to-Satellite Power Transmission

It has been suggested that there may be an advantage to developing space systems that are a group of individual free-flying modules broken down by function. This work has been promoted by DARPA through the System F6 program for fractionated spacecraft [3].

Possible benefits of satellite-to-satellite power transmission include that the solar power collection resource could be launched once, and it could support multiple payloads during the course of its lifetime. Greater flexibility is afforded, as clusters of satellites could be reconfigured while sharing power. Analysis by Sievenpiper [4] suggests that microwave satellite to satellite power transmission is not appropriate when distances are greater than 20 km or when used as a means to save weight with a single-

use system. A system implementer would be better off simply using more solar cells on one satellite, due to RF inefficiencies and increased complexity.

Lasers have been proposed for power transmission as well, but many of the same limitations still apply. One particular concern is how subsatellites would deal with “safe-hold” mode, the fallback position a satellite defaults to if a problem is detected, in which the satellite typically points to the Sun to charge its batteries with its solar arrays. This becomes problematic if the subsatellite has neither batteries nor solar arrays, and no easy way to find its power transmission satellite.

A strong counter argument to satellite to satellite power transmission is that in space, with an unobstructed view of the Sun at Earth distance, energy abounds. The 1350 W/m^2 that serves as the compelling motivation for SBSP is available everywhere for the taking, without the need for a complicated power relay system. However, for enhanced operations, a solar concentrator could prove effective (cf. Section 3.2.1).

2.7.2 Space to UAV for Dwell Extension

Current long-duration solar-powered UAV systems, while demonstrated to be feasible, are payload limited because a significant fraction of total vehicle mass must be dedicated to energy storage, usually in the form of batteries. Those batteries are essential to provide power during nighttime flight as well as to augment available solar power when the aircraft flies in attitudes or circumstances not favorable to solar energy collection. While significant advances in lightweight battery technology have been made in recent years, energy storage still comprises anywhere from 20% to 50% of total vehicle mass in flight-proven UAVs. Significant augmentation of overall UAV system capabilities is possible if a large fraction of that battery mass can be made available to the payload.

SBSP, provided in concert with local insolation at the UAV, can result in far less battery mass being required on the aircraft. In addition to providing additional power during daylight operations, a network of SBSP satellites can provide nearly continuous power to the UAV during local night. In fact, at typical UAV cruise power requirements of 75 to 100 W and typical wing areas of 1.2 to 2 m^2 , all the flight power for the bird could conceivably be provided by RF or light transmission from SBSP without exceeding the 100 W/m^2 controlled area limit of exposure currently accepted as human-safe.

Significant challenges include wireless power beam control to a comparatively small, moving target. This application is more plausible when taken in conjunction with a forward base SBSP scenario, where the UAV could fly through the wireless power beam already being sent to the base, rather than the UAV being a sole consumer.

The need for this application may have lessened in light of recent advances with multi-day flights of solar-powered UAVs that store enough energy to stay aloft through the night. An example of this from the summer of 2008 is the QinetiQ Zephyr, which flew continuously for 3-1/2 days at the U.S. Army’s Yuma Proving Ground [5]. Additionally, DARPA’s Vulture program [6] aims to develop UAVs capable of staying aloft for upwards of 5 years. Perhaps surplus power from such a craft could be wirelessly beamed to Earth much as SBSP would, albeit at a much shorter range.

2.8 Terrestrial Wireless Power Beaming Applications Apart from SBSP

In principle, any device or receiver system designed to accept SBSP might also function using RF or light energy beamed from terrestrial sources. This suggests that a network of SBSP and ground-based power transmission can be used to provide significant, near-continuous energy to remote locations anywhere on Earth.

Wireless power transfer also has utility in circumstances where it is impractical to set up conventional transmission lines or power mains for very short-term duty or across inhospitable territory. While not

technically SBSP, these applications have military utility, employ related technologies, and were deemed worthy of at least a cursory treatment in this report.

2.8.1 Ground-to-UAV for Dwell Extension

As one particular example, in addition to the potential power augmentation afforded by SBSP to UAVs in flight, it is also possible to wirelessly transfer RF energy to the aircraft from appropriately equipped ground stations. This capability can be considered as an adjunct or a redundant backup to SBSP power, and might be accomplished without significant modifications to UAVs designed to accept SBSP RF power.

The capability of beaming power from the ground to small- and medium-sized airborne UAVs using microwaves or laser light has already been demonstrated in a research context on several occasions in both the U.S. and Japan for many years [7,8].

UAVs often consume a large portion of their power during ascent. It is during this time or shortly thereafter that wirelessly beamed power may be of greatest utility.

The recent developments and demonstrations with long-dwell solar-powered UAVs described in Section 2.7.2 are applicable for use in this case as well, and may render it less relevant.

2.8.2 Ship-to-Shore Power Beaming

Representatives from the Navy and U.S. Marine Corps have expressed interest in attaining the capability of beaming power from a ship or other floating platform to a SEAL team or other seaborne or shore landing party. In such a situation, wired means of power transmission are likely to be impractical, and there is a limit on the resources a landing team could bring with it and preserve a high level of mobility. Similar situations between large forward bases and smaller bases in nearby hostile territory could employ wireless power beaming in lieu of expensive or dangerous fuel transfers, and would be less mass-constrained compared to the ship-to-shore case. These are examples where technology for SBSP overlaps with other desired military capabilities.

3. CONCEPT TECHNICAL FEASIBILITY ASSESSMENT

The idea of collecting energy from solar flux in space and transmitting it wirelessly to the ground dates back to the 1960s and is consistent with the laws of physics. In this regard, the concept is feasible. From a standpoint of providing power to the utility grid, the economics of deploying such a system have played a prominent role. It has been suggested that military applications may not be as tightly bound by economics, where a critical need may justify the likely added expense of power provided from an initial SBSP system.

SBSP cost models and estimates vary with implementation assumptions. A detailed cost analysis was beyond the scope of this study, but could be undertaken for a military SBSP application scenario following the establishment of a baseline concept of operations. One of the multitude of existing SBSP cost models could likely be tailored to examine defense application costs [9]. Even without a comprehensive cost analysis, component technologies and approaches can be assessed for feasibility by reviewing rough metrics such as the following:

- Lifetime power delivered per cost (kWh/\$ - higher is better)
- Conversion capacity mass per power (kg/W - lower is better)
- System specific power (W/kg - higher is better)
- Generation cost efficiency (W/\$ - higher is better)

- Launch volume stowed power density (W/m^3 - higher is better)
- Fuel needed per space segment mass ($\Delta v/\text{kg}$ - lower is better)

3.1 Some Proposed System Architectures

In the intervening decades since Peter Glaser proposed the idea of a solar power satellite [10], many architectures have been proposed. Presented here are summaries of a few concepts that may be relevant to an SBSP system for military applications. Those employing microwave power transmission employ a ground station equipped with rectennas to rectify the power to DC. The area required for the rectennas is generally on the order of kilometers and decreases with increasing frequency. Common targeted frequencies are 2.45 and 5.8 GHz. Each of these architectures avoids the use of slip rings for transferring massive amounts of power from the Sun-pointing collection array to the Earth-pointing transmission antenna, which had been common in previous architectures. Slip rings are generally deemed to pose a service life risk due to their mechanical nature, especially when used in conjunction with large currents and voltages.

3.1.1 SPS 2000

The SPS 2000 concept (Fig. 2) uses a triangular prism approximately 300 m on each side orbiting equatorially at an altitude of 1100 km. It uses retrodirectively controlled microwave power transmission and photovoltaics. It was designed with the intent of providing carbon-free power to tropical developing nations. A subscale functional ground model was demonstrated in 1995 by Japan's Institute of Space and Astronautical Science [11,12].

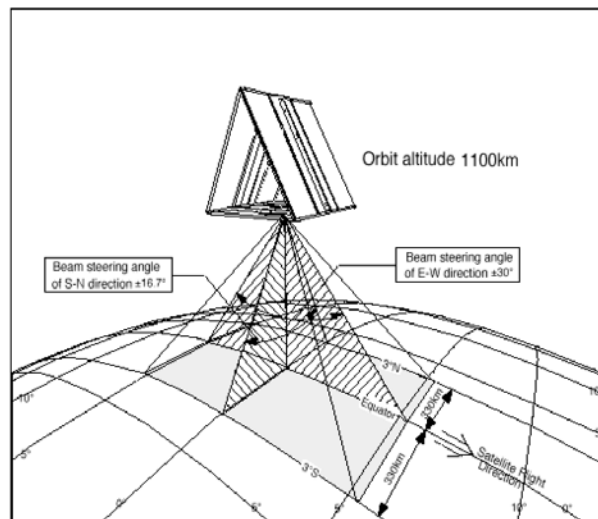

Fig. 2 – SPS 2000 [12]

The low Earth orbit (LEO) inherent in this design means that the time spent in view of any given ground location is limited on the order of 15 minutes. Antenna and spacecraft slewing and pointing further limit the time that could be spent downlinking power without implementing a constellation of multiple spacecraft. No power is provided when the spacecraft is eclipsed by the Earth, as happens during local night.

3.1.2 Sun Tower

The Sun Tower concept (Fig. 3) evolved from the 1995 NASA “Fresh Look” study. It consists of a gravity gradient stabilized string of modular units with Sun tracking inflatable Fresnel lenses to focus solar flux onto photovoltaics in GEO. A separate microwave antenna provides wireless power transmission. Some versions included multiple collection strings [13]. A known problem is that the reflectors will shadow each other during noon and midnight, possibly necessitating multiple satellites [13].

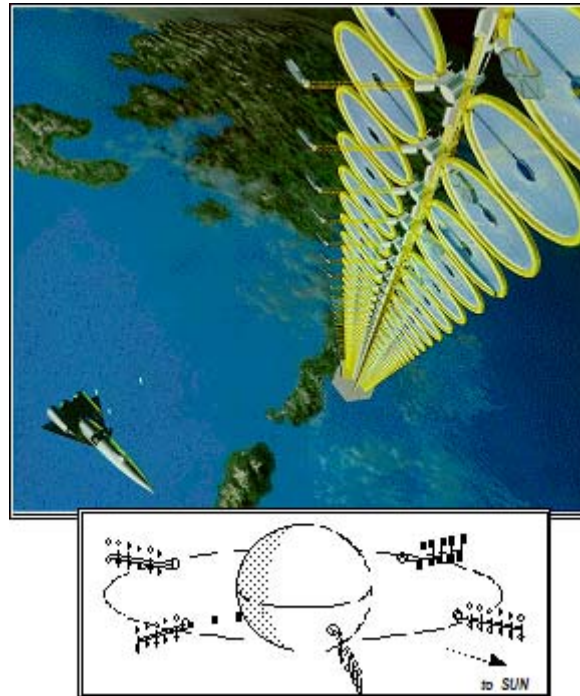

Fig. 3 – Sun Tower [14]

3.1.3 Modular Laser Constellation

Arising from NASA’s Space-based Solar Power Exploratory Research and Technology (SERT) program, the Aerospace Corporation formulated a laser Space Solar Power (SSP) system (Fig. 4) consisting of on the order of 200 individually launched Laser SSP satellites. Each would beam several MW of energy to a single 1-km diameter ground-based receiving photovoltaic (PV) array. The photovoltaic bandgap would be tuned to the laser downlink wavelength. The average beam energy density intercepted by the receiver could be limited to equal the solar flux at the Earth’s surface of approximately 1 kW/m^2 [15,16]. Weather conditions that affect atmospheric transmission qualities would likely necessitate multiple alternate receiving sites.

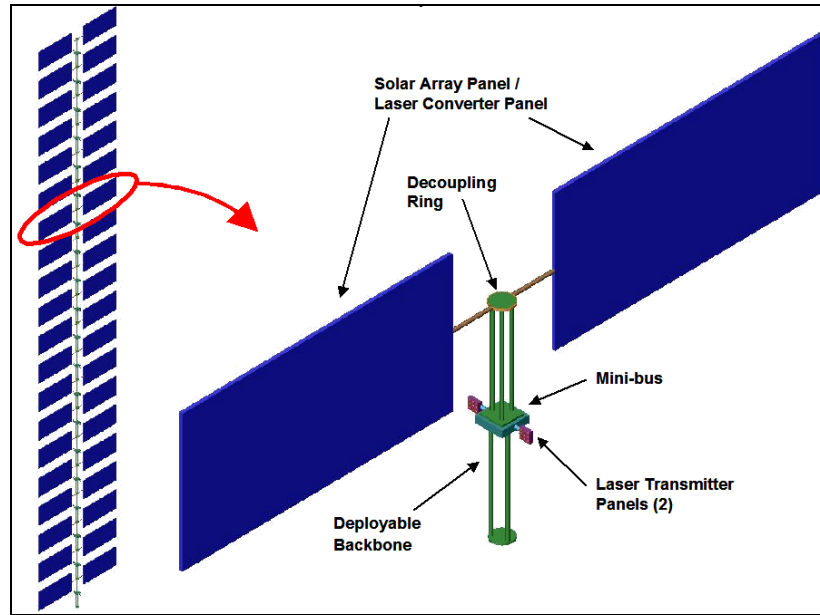

Fig. 4 – Aerospace Laser Concept [15]

3.1.4 Modular Symmetrical Concentrator

The Modular Symmetrical Concentrator (Fig. 5) is among the most popular concepts in 2008, and has support from international SBSP authority and former NASA research and development manager John Mankins. This GEO-based system uses modularity widely and avoids the concentration of large currents or voltages in the system by using reflectors to distribute solar flux power density so as to match the desired RF beam pattern on an array of solar-to-RF-conversion “sandwich” modules. Each sandwich module integrates a layer of photovoltaics, DC-to-RF conversion, and phased array antenna elements [17]. The thermal challenges and other aspects of the sandwich module require more study.

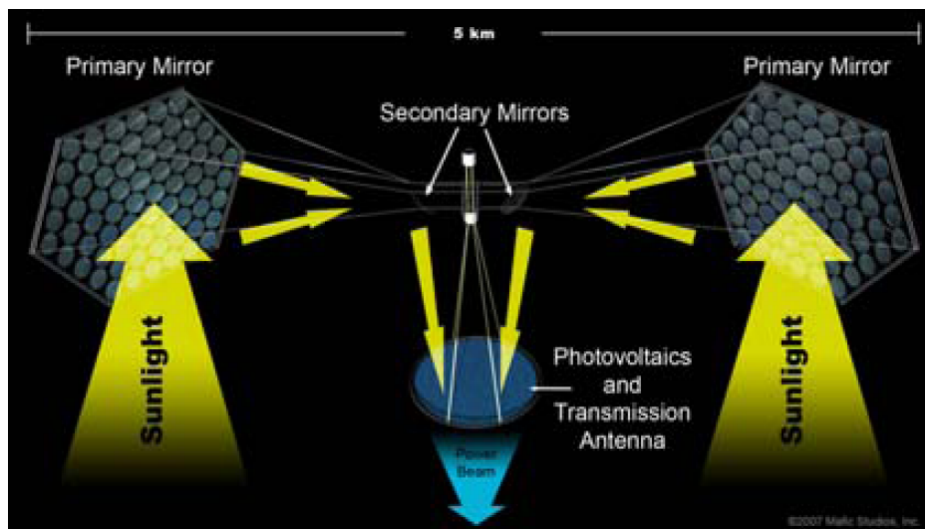

Fig. 5 – Modular symmetrical concentrator [18]

3.1.5 Perpendicular to Orbital Plane (POP)

This class of architectures includes a variety of GEO concepts that do not use gravity gradient stability. Generally, a microwave transmitting antenna of 500 to 1000 m in diameter is fed by photovoltaic arrays on either side along an axis perpendicular to the orbital plane. Concentrators may or may not be used. Attitude control and power management and distribution pose some of the challenges of this design.

Figure 6 shows one notional NRL concept of a space-based solar power system designed to deliver 5 MW electric power to Earth from GEO; this concept is original to this study. This design limits the solar array area to support the desired power while retaining the microwave antenna that must have a 1-km diameter. Assuming overall efficiency of 10% between intercepted sunlight and electric power delivered on Earth, the area of each of the two solar arrays is 18,300 m² or 152 m diameter. The two arrays are fixed to the primary truss structure on the back of the transmit antenna facing the north-south axis. The arrangement of components minimizes the mass of electrical power cables. Flat solar reflectors in elliptical 165-m × 240-m rims rotate about this axis to track the Sun. The Mantech SRS reflectors are of space-qualified polyimide with 94% reflectivity and an NRL-patented edge treatment that prevents distortions in the large areas of material. (NRL has worked with SRS on projects involving polyimide reflectors.) The solar arrays' position allows them to radiate waste heat from both faces, as in conventional spacecraft practice. Both the antenna structure and the reflector rims are NRL large-structures technology described in this report.

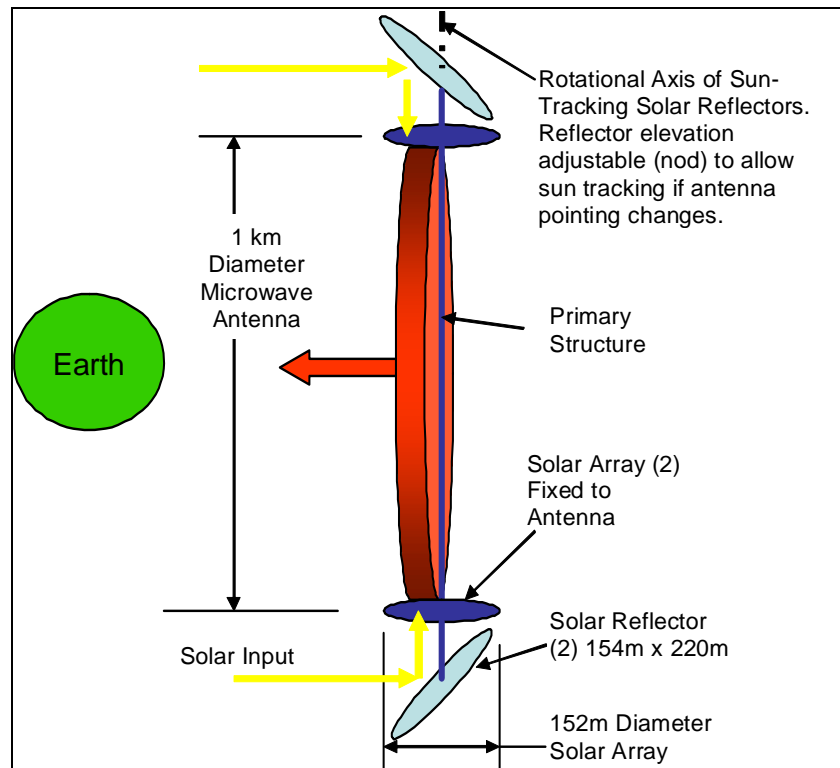

Fig. 6 – 5-MW solar power system

3.2 Power Collection

The power density from solar flux at Earth's average distance from the Sun is approximately 1350 W/m². A 5-MW (delivered power) SBSP system similar to that recommended by the NSSO report as a large-scale GEO demonstrator would likely require at least 30,000 m² of solar collection after accounting for collection, transmission, and reception inefficiencies. Some proposed means of solar flux collection are detailed below.

3.2.1 Solar Dynamic

Solar dynamic power (SDP) systems use an engine to generate power. An example of this is a Brayton cycle engine heated by a point-focus solar concentrator. NRL worked with NASA Glenn Research Center in developing means to integrate their systems for unmanned space vehicles, but the maximum efficiency SDP attained with this technique is generally considered not currently competitive with photovoltaics [19]. For good Carnot efficiency, the SDP requires a low temperature sink, easy to obtain with cooling towers on Earth but requiring a radiator of enormous size in space. NASA is working only with Stirling cycles powered by radioisotopes for deep space applications and fission-powered Brayton cycle systems for lunar applications [20].

In recent years, significant advances in thermoelectric conversion engines other than the traditional thermal-mechanical-electric (i.e., other than Stirling or Brayton piston generators) have occurred, and use of these technologies may prove cost-effective in non-photovoltaic SBSP systems. Both solid-state (junction thermionic) and thermal-ion-electric generators (e.g., the Ericsson cycle Johnson Thermo-Electrochemical Converter) now claim significantly higher conversion efficiencies than those achievable with comparable mechanical systems. This may at least partially obviate the need for radiators as large as are required for the mechanical systems. It is beyond the scope of this study to analyze any of these alternate specific implementations' suitability for SBSP electric power generation, but it is important to note that these emerging technologies should be assessed for applicability before all non-PV architectures are dismissed [21].

3.2.2 Photovoltaics

Photovoltaics are most often considered for SBSP. There are several approaches to using photovoltaics:

- a. Conventional high-efficiency spacecraft solar cells on flat panels (no concentration): Today's spacecraft use flat PV arrays almost exclusively, but they may not be suitable for SBSP. Deficiencies include:
 - Current (CY 2008) solar cell costs of roughly \$200k/m².
 - PV cell array integrated systems cost approximately \$1M/kW.
 - Low specific power: about 60 W/kg of array [22].
 - Low packing density of the rigid array panels, about 10kW/m³ [22].
 - Low operating voltage, about 100 V at most, likely resulting in a very large mass of conductors in the very large arrays proposed for SBSP unless PV cells are closely integrated with DC-to-RF converters (as in the sandwich scheme) [22].
- b. Photovoltaic point-focus solar concentrators: A typical system as proposed for SBSP might have large diameter parabolic reflectors of hundreds of square meters, each focusing sunlight on small receivers of PV cells, with a concentration ratio (reflector to cell area ratio) of perhaps 500:1. An advantage is that the area of expensive PV cells is minimized and concentrated sunlight increases cell efficiency, but solar energy not converted to electricity must be dissipated. Terrestrial applications cool the PV cells with water, but space applications must have a means of thermal radiation to

dissipate the heat. Its projected area may approach the reflector area, and a two-phase fluid loop or other thermal management system could be required to spread the heat over the radiator surface. Dichroic reflectors, such as those used in studio lighting, might alleviate the thermal problem to some degree by only reflecting a range of optical frequencies that are within the photovoltaic bandgap. Nonetheless, the probable complexity of this system poses challenges.

The Defense Advanced Research Projects Agency (DARPA) as part of its Fast Access Spacecraft Testbed (FAST) is promoting the development of increased performance solar power systems. Employing deployable concentrators to achieve 40:1 to 100:1 concentration, it is envisioned that specific powers for the power subsystem of 130 W/kg or higher may be attainable. This work is being performed under the High Power Generation Subsystem (HPGS) technology development program [23].

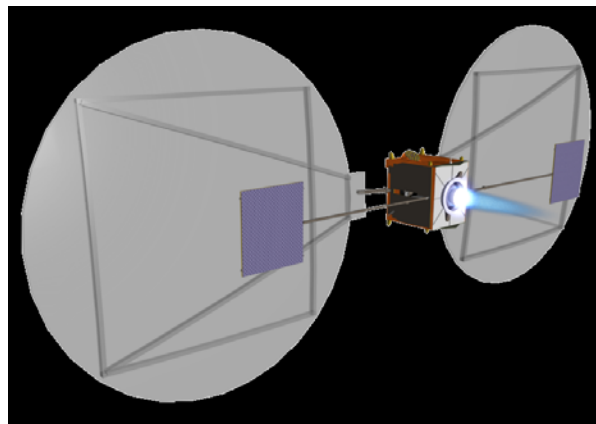

Fig. 7 – DARPA FAST Concept Vehicle showing concentrators [23]

- c. Small-area solar concentrators: In this approach, the heated area is small enough and the concentration ratio low enough that the heat can be dissipated by conduction into a radiator surrounding the PV cell. A commercial PV system with this design is the “Stretched Lens Array” (SLA) by Entech Corporation. The concept uses a thin-film, linear Fresnel lens that focuses sunlight on a narrow strip of PV cells that rest on a radiator [22]. This design has a concentration ratio of 8.5:1, so it uses only 1/8 the cells of a flat PV array, and the concentrated sunlight increases cell efficiency. Stowed power density is about 100 kW/m^3 , specific power is 300 to 500 W/kg, and SLA has four times the W/dollar of a flat PV array. Of particular importance to this present design work is that the SLA integrates easily with NRL’s large deployable structure technology (described below). However, the most important predicted advantage of the SLA, something that could make it a breakthrough technology for SBSP, is an operating voltage of 1,000 V. This could eliminate tons of copper wiring from a 5-MW SBSP, a great savings in the cost of transporting mass to GEO, and could allow the use of slip rings between an Earth-facing microwave antenna and a Sun-tracking PV array.
- d. Sandwich cells (see Section 3.1.4): These devices have a photovoltaic cell on one face, a DC-to-RF converter in the middle, and a microwave emitter on the opposite face. This allows for the elimination of electrical conductors and slip rings between a PV array and a microwave antenna as seen in many conventional SBSP systems. This device is used in the Modular Symmetrical Concentrator SBSP system shown on the cover of the NSSO report “Space-Based Solar Power, an Opportunity for Strategic Security.” The sandwich module appears to have formidable thermal challenges. It is

intended to operate in a solar concentrator system, but conversion inefficiencies and the resultant high temperatures may exceed the operating temperature limits for microwave devices.

3.2.3 Passive Solar Reflector

An entirely passive system could be implemented by merely deploying a massive reflector to divert solar flux for ground-based collection. The approach is probably suitable for a large structures demonstration, but is likely is too inefficient for practical application.

3.2.4 Solar Pumped Laser

Solar pumped lasers are an intriguing collection means. They are addressed in this report in the DC-Optical conversion section (3.4.4) because they encompass aspects of SBSP beyond simple collection.

3.3 Wireless Power Transfer

There are two primary options for transferring power from the spacecraft to a receiver: microwave and laser. The key system tradeoffs that must be considered to select the optimum technology are a) conversion efficiency (solar to microwave or laser, and microwave or laser to prime electrical power at the receiver), b) transmitter size and mass, c) receiver size and mass, d) transmission losses due to attenuation, diffraction, scattering, etc., and e) safety and environmental issues.

For transmission to a receiver on the ground, atmospheric attenuation is a critical factor that severely impacts all-weather effectiveness at frequencies above ~5 to 10 GHz. A representative plot of space-to-Earth microwave attenuation under several atmospheric conditions is shown in Fig. 8 (for normal incidence). In the infrared (IR) and optical regime of laser transmission, typical attenuation levels are 2 to 10 dB due to varying cloud cover conditions, even for a receiver at an altitude of 2300 m, as illustrated in Fig. 9 [24]. At sea level, the attenuation is a minimum of 0.5 dB higher for viewing at zenith under clear sky conditions (visibility of 23.5 km), 2.0 dB higher for viewing at zenith under hazy conditions (visibility of 5 km), and at least 5.0 dB higher for viewing at an angle of 70 degrees from zenith under hazy conditions (visibility of 5 km) [25]. Atmospheric attenuation is very dependent on weather, dust particle contamination, ground site altitude, and the observation angle from the zenith. If the observation path travels at an angle through the highest density region of the atmosphere, absorption and scattering by air molecules can be dominated by absorption and scattering by solid or liquid particles suspended in the air.

These conditions relating to weather, dust, wind speed, and humidity contribute a significant and highly variable factor. An atmospheric modeling tool such as MODTRAN, which is a computer program developed by the Air Force, can be used to accurately estimate the transmittance and sky radiance for a variety of atmospheric and site-specific conditions [26]. The magnitude and variability of atmospheric attenuation at short microwave, millimeter wave, and optical wavelengths are a major reason that the large majority of space-based solar power concepts for ground-based receivers have used either 2.4 or 5.8 GHz microwave transmission (corresponding to ISM bands). Of course, if the power is being beamed to a platform above the bulk of the Earth's atmosphere, the attenuation is not a factor and there are strong arguments for operating at higher frequencies, cf. Fig. 8 and Fig. 9.

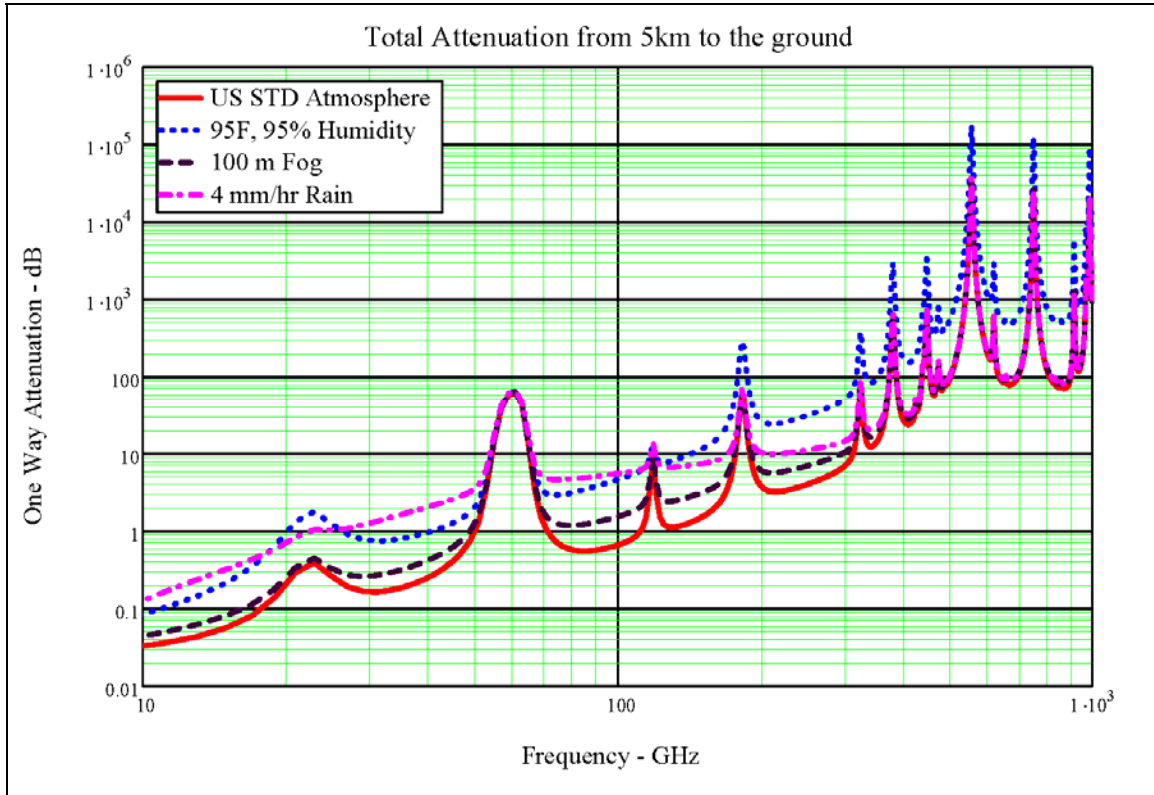

Fig. 8 – Atmospheric attenuation vs microwave frequency (from Bruce Wallace, MMW Concepts LLC)

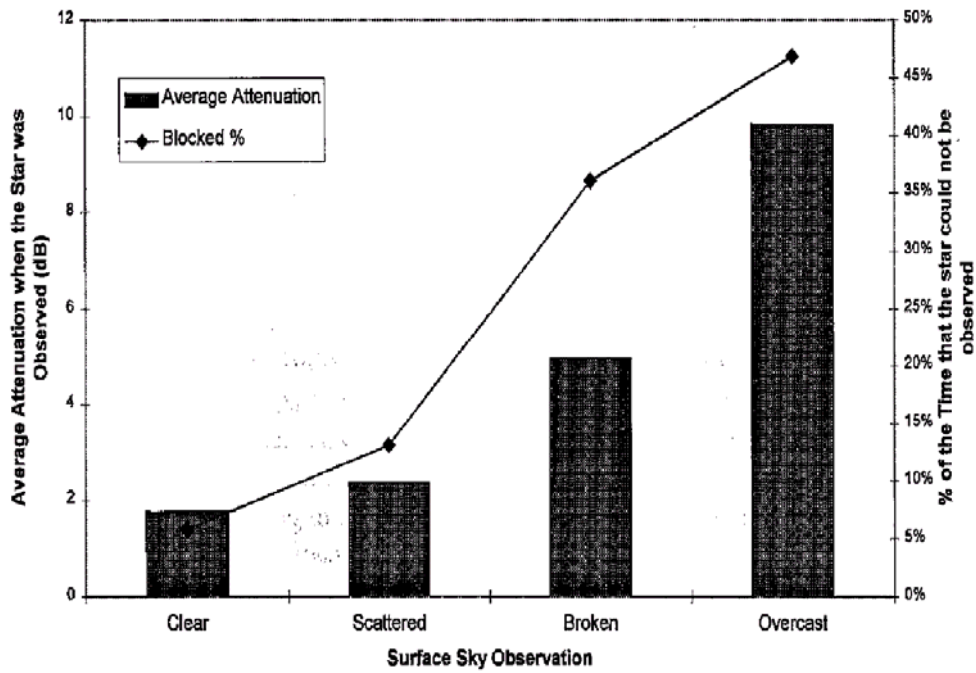

Fig. 9 – Average optical attenuation at Table Mountain, CA (elev. = 2.3 km) for different sky conditions [27]

A strong motivation for transmission at high microwave frequencies or at optical wavelengths is the much smaller transmitter and receiver apertures required. While it is possible to design very efficient antennas for this application, the apertures required at 2.4 or 5.8 GHz are extremely large (>1 km) for GEO designs. This is clearly illustrated by the reference designs that have been generated over the last decade or so, primarily by NASA and JAXA (Japan Aerospace Exploration Agency), as summarized in Table 3. Of particular interest for our purposes are the relatively modest power densities at the receiver given the extremely high total power levels and antenna sizes. These concepts generally assume that both the transmitter and receiver antennas are optimally designed, with a Gaussian amplitude profile across the apertures. As shown in Fig. 10, the diffraction-limited transmission efficiency can approach 100% if the parameter $\tau \sim 2$, where $\tau = \sqrt{A_T A_R} / (\lambda D)$ relates the antenna areas A_T and A_R to the wavelength λ and transmission distance D .

Table 3 – Typical Parameters of Various GEO-Based SBSP Concepts [28]

Model	Old JAXA model	JAXA1 model	JAXA2 Model	NASA-DOE model
Frequency	5.8 GHz	5.8 GHz	5.8 GHz	2.45 GHz
Diameter of transmitting antenna	2.6 km ϕ	1 km ϕ	1.93 km ϕ	1 km ϕ
Amplitude taper	10 dB Gaussian	10 dB Gaussian	10 dB Gaussian	10 dB Gaussian
Output power (beamed to earth)	1.3 GW	1.3 GW	1.3 GW	6.72 GW
Maximum power density at center	63 mW/cm ²	420 mW/cm ²	114 mW/cm ²	2.2 W/cm ²
Minimum power density at edge	6.3 mW/cm ²	42 mW/cm ²	11.4 mW/cm ²	0.22 W/cm ²
Antenna spacing	0.75 λ	0.75 λ	0.75 λ	0.75 λ
Power per one antenna (Number of elements)	Max. 0.95 W (3.54 billion)	Max. 6.1 W (540 million)	Max. 1.7 W (1,950 million)	Max. 185 W (97 million)
Rectenna Diameter	2.0 km ϕ	3.4 km ϕ	2.45 km ϕ	10 km ϕ
Maximum Power Density	180 mW/cm ²	26 mW/cm ²	100 mW/cm ²	23 mW/cm ²
Collection Efficiency	96.5 %	86 %	87 %	89 %

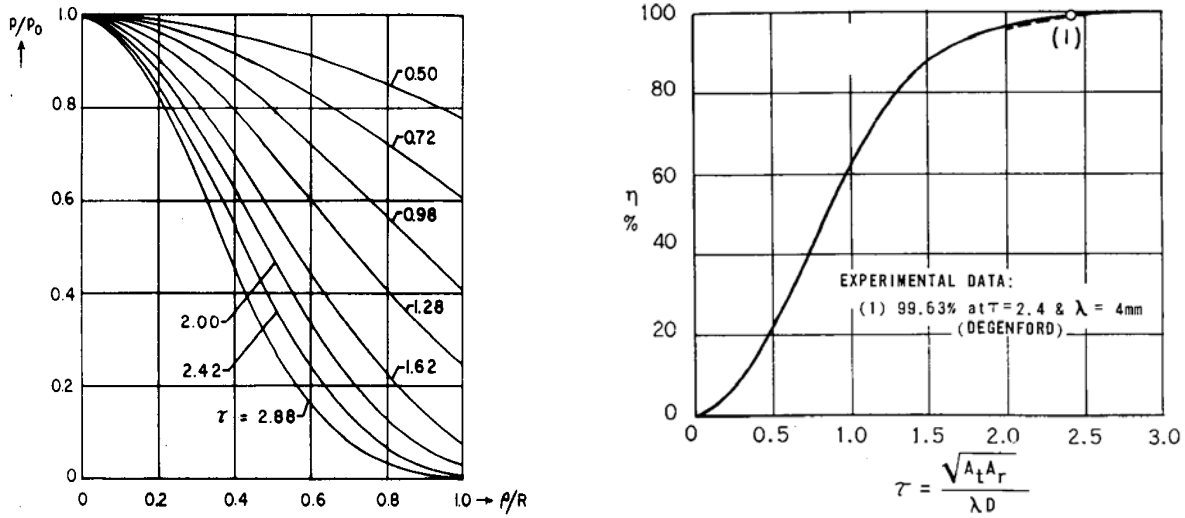

Fig. 10 – Optimal power distribution across antenna (left) and transmission efficiency (right) for various values of τ [29]

Note from Fig. 10 that for $\tau = 1.62$, the power density at the edge of the antenna is about 10% of the power density at the center, while the average power density over the full aperture is 38% of the central power density. The transmission efficiency for this case is 90%. This information can be used to calculate the relationships between transmitter antenna size, transmitted power, power density at the receiver, and microwave frequency.

Results are shown in Fig. 11 and Fig. 12. These results assume an optimal Gaussian profile across the transmitter aperture with $\tau = 1.62$. The computed transmitter power levels also assume 1 dB of atmospheric attenuation at 94 GHz and 0.4 dB attenuation at 35 GHz.

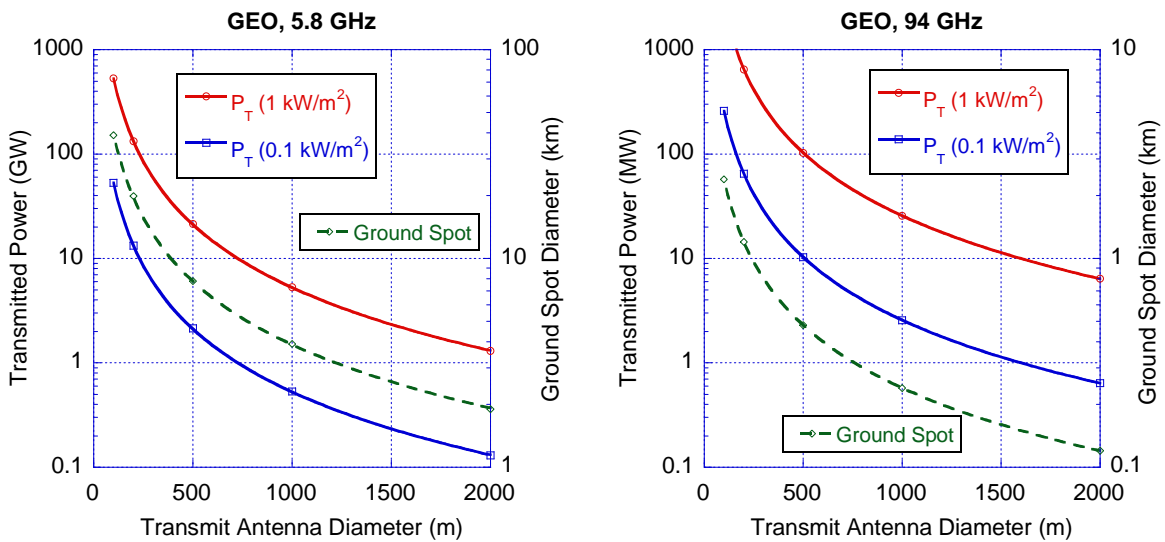

Fig. 11 – Transmitted power required to generate a peak power density of 0.1 or 1 kW/m² at the ground, and diameter of ground spot containing 90% of power vs transmitter aperture, assuming GEO-based transmitter at 5.8 or 94 GHz.

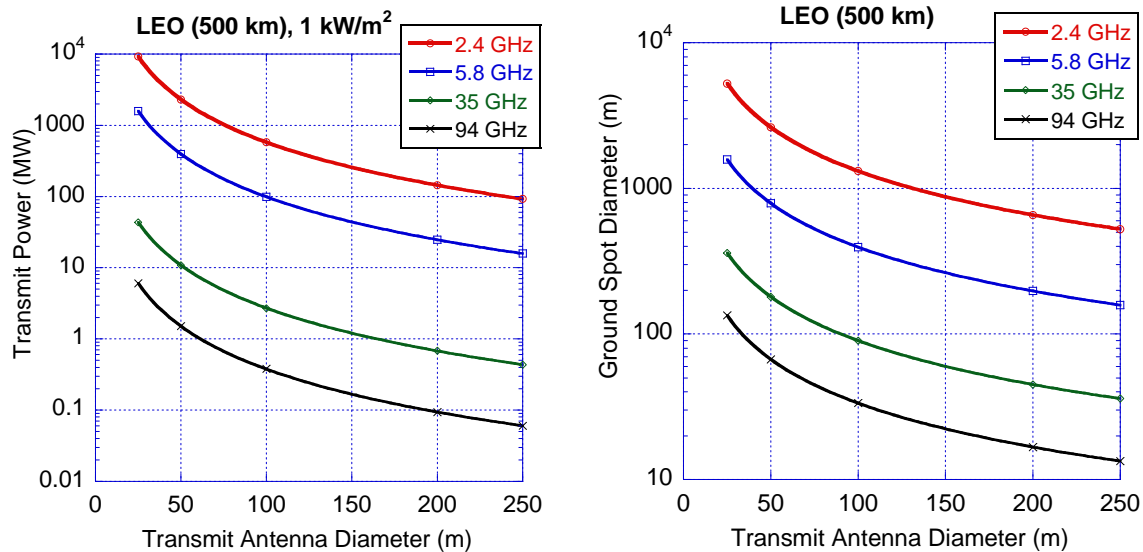

Fig. 12 – Transmitter power required to generate peak power density of 1 kW/m^2 at the receiver (left) and diameter of ground spot containing 90% of power (right) vs transmitter aperture, assuming LEO-based transmitter.

The curves show that to achieve tactically useful power densities on Earth, some combination of very high transmitter power and very large transmitting antenna will be required. These requirements lead to fundamental technical challenges for fielding a tactical space-based power transmission system, especially at GEO. For the “all-weather” wavelength of 5.8 GHz and assuming a transmitter aperture ≤ 2 km, it will be necessary to generate gigawatts of RF power to produce 1 kW/m^2 of radiation on the ground, which is approximately the same as the solar fluence reaching the ground on a clear day.

In general, there is also likely to be a large degree of spillage of the transmitted power around the receiver, even in the LEO configuration, because the beamwidths are quite large. This raises safety issues, because the maximum permitted exposure level (PEL) at these frequencies in a restricted area is 10 mW/cm^2 (100 W/m^2), and in an unrestricted area 1 mW/cm^2 (10 W/m^2 (IEEE C95.1-1999)). For the cases plotted above, the power density at the edge of the specified ground spot is 10% of the maximum field, so to obtain 1 kW/m^2 at the center of the beam, the restricted area PEL will be exceeded by a factor 2 at the spot diameter indicated, and the unrestricted area PEL will be exceeded by a factor of 10. For high-altitude receiver applications, operation at higher frequencies can be advantageous from a safety standpoint as well as from beamwidth considerations, because relatively high power density can be delivered to the receiver while the spillover will be further attenuated before reaching the ground.

Efficient laser transport can of course be achieved with significantly smaller apertures than those illustrated above for microwave transmission. The maximum power density that can be safely implemented then becomes a more critical issue, and one that involves policy issues as well as technical ones.

Although the microwave transmission situation is much better at higher frequencies, at least for a clear atmosphere, the power conversion efficiencies are lower, as is discussed below. Also, in a humid atmosphere or in rain, the attenuation at 35 and 94 GHz can be larger by a factor of 5 or more than assumed above, so the transmitted power would have to be increased accordingly to achieve the specified receiver power density. Any system design will have to carefully account for these complications. Additional technical details are found in Appendix C.

3.4 Collection, Conversion, and Reception Technologies

3.4.1 Solar Cell Efficiencies

Many different solar cell technologies are currently under development and efficiencies are continuously increasing. This section is intended to summarize recent information on the efficiencies and radiation hardness of currently or soon to be available solar cell technologies. Table 4 summarizes the solar cell efficiencies.

Reference 30 provides a recent, comprehensive summary of the highest published efficiencies for a wide variety of different technologies under standard, terrestrial test conditions, i.e., air mass 1.5 spectrum (AM1.5).

These efficiencies will be reduced under an air mass 0 (AM0) spectrum because the AM0 spectrum has more ultraviolet and infrared light, which is converted less efficiently. For the triple junction cells, the reduction is about 2 absolute percentage points.

The highest efficiencies are achieved by triple junction (3J) solar cells. The latest generation of triple junction cells (GaInP/GaAs/Ge) have beginning of life (BOL) AM0 efficiencies of almost 30% [31,32]. These cells currently dominate the satellite market due to their high power output per system mass [33]. The next generation of 3J cells (GaInP/GaAs/InGaAs) have demonstrated AM0 efficiencies of 32%, and 33% is believed to be achievable in production [34]. In addition to their enhanced efficiency, they are thinner and more flexible than current 3J cells because the growth substrate is removed. This should allow lighter arrays to be designed.

Cells based on 3J technology optimized for concentrated light have demonstrated efficiencies of up to 40%, although this does not take into account any losses in the concentrating optics. At least one manufacturer is producing 37% efficient cells in volume. Si cells have demonstrated a maximum 27.6% efficiency at 500 suns and 26% in production [35]. System efficiencies are 5% to 10% lower than the solar cell efficiencies due to losses in the optics [36]. For example, in outdoor tests, 3J concentrator systems have demonstrated efficiencies above 22% with 31% efficient cells [37]. A system efficiency of 27% AM0 has been reported for a solar concentrator system designed for space applications [38,39]. The system has a relatively low concentration factor of 8, making the problem of keeping the cell cool in vacuum more manageable. The tradeoff is that cell efficiencies are reduced compared to terrestrial concentration systems since cell efficiency typically peaks at concentrations above 100.

Table 4 – Summary of Solar Cell Efficiencies

Cell Type	Demonstrated Efficiency of Laboratory Devices	Efficiency of Production Devices
Triple junction concentrator cells (GaInP/GaInAs/Ge)	40.7% @ 240 suns	37% @ 1000 suns, 25 °C, 1 cm ² aperture (Emcore)
Triple junction 1 sun (GaInP/InGaAs/Ge)	33.8%	28.6% AM0 (Emcore) 28% AM0 (Spectrolab)
Thin Film Crystalline TJ GaInP/InGaAs/InGaAs (IMM)	32% AM0	
Single crystal GaAs	25.1%	
Single crystal Si	24.7%	22%, 5" (Sunpower)
Single crystal InP	21.9%	
Multicrystalline Si	20.3%	16%, 6" (Solarfun) 18.5% (Kyocera)
thin film CuIn _x Ga _{1-x} Se ₂ on glass	14.5% (Nanosolar, Daystar)	
thin film CuIn _x Ga _{1-x} Se ₂ on flex subst		10% (Global Solar Energy, Nanosolar)
Thin film CdTe on glass	16.5%	10.5%, 2' × 4' (First Solar)
Amorphous Si, nanocrystalline Si, dye sensitized, organic polymer	<12%	Ovonics Solar

Thin film CuIn_xGa_{1-x}Se₂ (CIGS) cells and amorphous Si (a-Si) cells have also been proposed for space applications despite their lower efficiencies. These cells can be grown on lightweight, metallic substrates reducing the power per unit weight advantage of triple junction cells [40]. Also, both of these types of cells are relatively resistant to radiation damage and anneal at temperatures below 150 °C [41,42]. However, a-Si cell efficiencies have not been demonstrated much above 10%. The efficiencies of commercially available CIGS cells are presently ~10% to 13%, well below the maximum values demonstrated for smaller test cells and similar to a-Si cell efficiencies.

Organic solar cells and dye-sensitized cells are still under development. Efficiencies are generally low (less than 10%), radiation hardness is unknown, and commercial production has not yet begun. In space, solar cells degrade due to radiation damage. Electrons and protons from the Sun displace atoms in the cells, causing excess recombination and eventually carrier depletion/type conversion. The rate of degradation depends on the type of cell, the radiation spectrum of the orbit and any shielding due to a coverglass or other coatings. Fig. 13 shows the effect of displacement damage (Dd) on bare solar cells of several different types [43]. Dd is a measure of the displacement damage that can be computed for any orbit given its radiation spectrum and the timeframe required. For example, after 15 years in a geostationary orbit with a 3 mil coverglass, Dd ~5 × 10⁹ (MeV/g). At this damage level, a 3J cell's efficiency is degraded by about 10% to 15% [44].

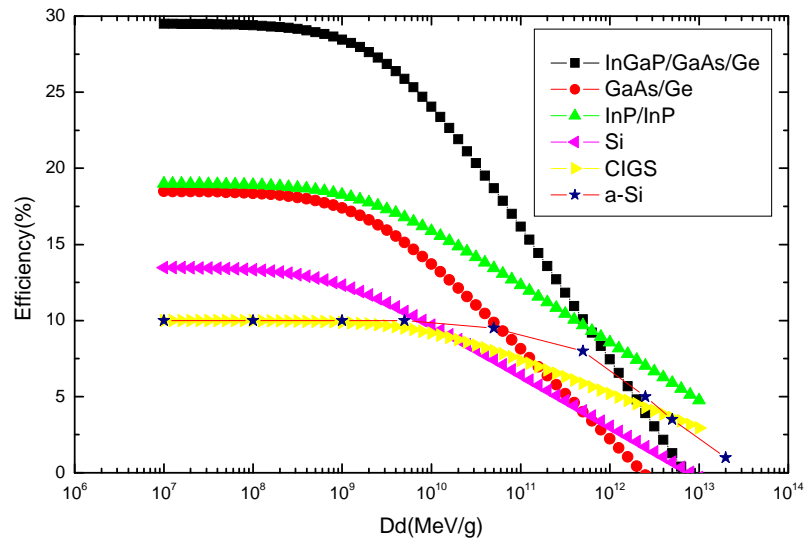

Fig. 13 – Solar cell efficiency as a function of displacement damage (Dd)

InP, CIGS, and a-Si cells are the most radiation-hard solar cell materials. The fluence where their efficiency is reduced by 50% power is an order of magnitude higher than it is for 3J, GaAs, or Si cells. Nevertheless, in the absence of annealing and taking into account their lower BOL efficiencies, the value of Dd where they become more efficient than a 3J cell is between 5×10^{11} (MeV/g) and 1×10^{12} (MeV/g), corresponding to more than 750 years in geostationary orbit.

Concentration systems may also be radiation tolerant because the cells do not have to be exposed directly [45]. However, each system will be different, and little experimental work on radiation damage has been done for concentration systems, so direct comparisons with other systems are not possible at this time [46].

3.4.2 Spaceborne Power Conversion and Control

The largest spacecraft electrical power subsystem (EPS) in orbit is the Space Station. It has solar arrays operating nominally at 160 V, but the station controls the bus voltage to 120V. This system was nominally designed to deliver 84 kW of usable power to station loads in a ~90 minute LEO orbit with 35 minute eclipses. This means that the arrays pull in more power than 84 kW, but this power is used to recharge the batteries. The power system is very large and complicated, but it does work. The station is the only place where we can get a real world look at the sizing that begins to approach a precursor of that needed for space-based solar power. A relatively small 5-MW space-based solar power satellite, running at the same bus voltage, would require an EPS roughly 60 times more capable than the station's present power system [47].

The solution approach for this capability increase would need to be twofold: raise the voltage on the solar arrays to 500 to 1000 V range (or higher), and develop electronics that could operate directly from those voltages. Entech has solar concentrators that can run at 600 V, so there is at least the capability to build the solar array that produces power at those voltages. Entech is working on these arrays for a lunar space tug concept using electric propulsion, which, ideally would run directly off the high voltage of the solar array rather than being up-converted. Here, the same would be needed – have high voltage/high power DC to energy conversion electronics designed such that the array directly drives those boxes. If the array has the voltage and current, the energy would be flowing to the ground site. There would likely also

be a low voltage, lower power bus using a dedicated array and batteries that would allow the vehicle to survive LEO orbits, LEO-to-GEO transfer, and, finally, GEO cycles. A bus voltage that could also power a solar electric propulsion system directly at the same time is recommended.

A limiting factor to the EPS is conduction efficiency. The currents, even at 1000 V, will be massive even for modest systems. Small amounts of distribution resistance will result in appreciable power lost as waste heat in the spacecraft. This is in addition to the solar efficiency and DC-to-energy transfer efficiency losses.

Another limiting factor to the EPS is storage. The spacecraft would need to have a massive battery system and battery charge control if storage was required to maintain energy flow during eclipse periods. The complexity of a large storage system with hundreds of batteries is significant.

This is definitely an area where extensive developments are required.

3.4.3 DC-RF Conversion

A number of technology options are available for conversion of DC power to RF power. Important factors that influence the selection of the optimum converter are a) conversion efficiency, b) operating voltage, c) mean time between failures (MTBF), d) form factor (size, weight, and power per module), and e) cost per watt. Table 5 lists the most appropriate technologies at the primary RF frequencies of interest (2.4 to 6 GHz) and summarizes some of these factors.

Table 5 – Source Technology for 2.4 to 6 GHz SBSP RF Transmission

RF Source	Power/ module (kW)	Efficiency (%)	Comments
Klystron	10-100s	70 – 75	High voltage, heavy, moderately expensive
MBK	10-100s	70 - 75	Moderately high voltage, expensive
TWT	0.1-0.3	65 - 75	Space qualified, relatively compact, moderately expensive
Magnetron	0.5-5	75 - 85	Inexpensive, compact, phase controllable
GaN SSPA	0.01 – 0.1	50 - 70	Compact, expensive, thermal issues
(MBK: multiple beam klystron, TWT: traveling wave tube, SSPA: solid-state power amplifier)			

The RF source technology selected must be matched to the transmitting antenna, probably either a large dish or a phased array. A dish antenna favors higher source power per module, thereby reducing the number of power combiners required. A phased array is more compatible with lower source power per module, because the higher power sources will require large numbers of power splitters and phase shifters, adding weight, complexity, and additional power loss to the system. The high power klystrons also operate at much higher DC voltages (10s of kV), presenting a breakdown problem in space, and the higher power per module tends to create a more concentrated thermal loading, presenting a serious cooling design challenge. A larger number of lower power sources are also more forgiving of isolated component failures.

Several particular devices are particularly relevant for this application and can be used to illustrate what is possible. They are as follows:

- COMET Magnetron transmitter (Japan): 300 W, 5.8 GHz, 7.5 kg integrated module including DC-DC converter, phase controller, antenna, and heat radiator. This transmitter was developed specifically for the SBSP application [48].
- TWT-based microwave power module (MPM): Example from L3 Communications: 220 W, 2.45 GHz, 2.7 kg (including DC-DC converter, solid state driver, and TWT power amplifier). Widely deployed in military systems and space qualified.
- GaN HEMT: 80 W, 60% efficiency – representative state-of-the-art high-power, high-efficiency SSPA (e.g., Aethercomm Inc.). These devices are still in the developmental stage and have operational limitations, but the DoD is investing heavily in this technology.

At millimeter wave frequencies, which may be of interest for some specialized applications because of the much smaller transmitter and receiver apertures required, there are fewer available sources and they are generally less efficient. Gyrotrons are available for very high power (up to 100s of kW at 94 GHz) at efficiencies up to ~50% to 60%. Extended interaction klystrons (EIKs) can operate at average power levels of 100s of W at somewhat lower efficiencies (~30% to 40% with multistage depressed collectors). (A 200-W average, 2-kW peak power W-band EIK was recently used in NASA's CloudSat satellite). Maximum efficiency of these W-band devices can never be as high as in the lower frequency devices because of ohmic losses in the cavities or slow-wave structures (which are ~30% of the power generated). Gyrotrons also have some serious disadvantages for space applications, including the requirement of very large magnetic fields (usually produced via superconducting magnets), high thermal loading requiring active cooling, and high operating voltages (50 to 100 kV). W-band operation also presents a number of other operational difficulties due to a lack of some high-power components (phase-shifters and power splitters) and additional ohmic losses in such components.

There are many system design trades related to SBSP implementations based on present electron tube amplifier technology. Thin, multilayered active integrated antenna elements containing solid-state amplifier devices have been developed [49], but due to the relatively low-power output level of each panel, require configuration in an array-based system composed of a very large number of modules. Antenna array driver elements based on solid-state devices are an area of active research and development where advances in operating temperature upper limit, efficiency, and power handling capability could increase solid-state power amplifier output to above a few hundred W and efficiency above the current range. Whether the RF power generating unit drives a single feed location, such as waveguide horn driving a reflector that can be arranged as part of a cluster of radiating units, or a highly distributed flow through a power divider feed network that excites a large number of distributed array elements, antenna design has a significant impact on the optimization of the DC-to-RF conversion architecture.

The concept for space-based RF power transmission proposed by Kawasaki [49], based on the diagram of Fig. 14, uses a low-power signal source driving a relative small number of array elements per module through amplifiers, where the modules are then combined into a larger structure. Other system concepts, studied in papers from JPL and URSI, use higher power microwave tube sources in combination with tens or hundreds of thousands of waveguide slots or other radiating structures interconnected by a corporate feed network [50,51].

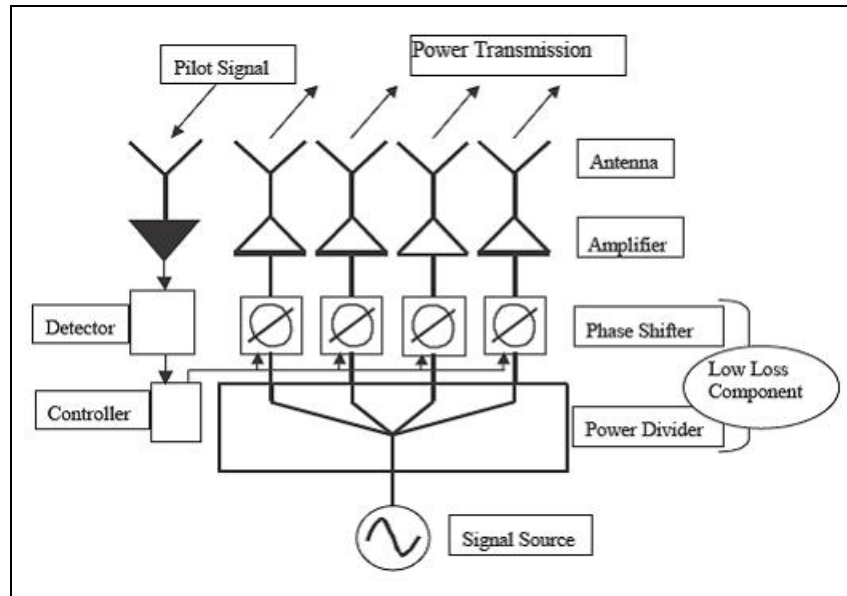

Fig. 14 – Block diagram of a feasible power transmission system [49]

Klystron electron tubes convert electron beam energy into radio frequency waves at very high power levels and can be configured to operate either as self-exciting oscillators or as power amplifiers. A pulse generating multiple-beam klystron (MBK) can reach a peak power level in the tens of MWs. These units are used to drive cavities in linear atomic particle accelerators where the RF energy provides the accelerating field gradient. Such units are very large and heavy, use very substantial permanent magnets, and have a DC-to-RF conversion efficiency close to 70% [52]. Present technology supports commercial production of continuous wave (CW) output klystrons providing from 30 kW RF up to 180 kW RF power with a weight on the order of 60 kg to 340 kg [53]. Cooling system requirements will increase the power amplifier system weight. Lightweight Klystron tubes intended for spacecraft communication systems have been developed with NASA funding (see Fig. 15), and these prototypes use electrostatic lenses instead of magnets for beam focusing to save weight [54]. Production devices can be anticipated to weigh less than 5 to 10 kg and produce output power levels at least in the 2 to 10 kW range.



Fig. 15 – A 2 kW 5.8 GHz klystron tube developed by Ebeam for NASA

Medium RF power output spaceborne systems such as telecommunication relay satellites and direct broadcast TV platforms have relied for many years upon travelling wave tube (TWT) power amplifier systems using multiple tubes typically providing 100 to 500 W of radiated power [55]. Higher power tubes in the 1 to 30 kW range are commercially available for terrestrial microwave communication systems where power and weight constraints imposed on the typical satellite do not preclude their use. Units built for operation in the 8.5 GHz to 9.5 GHz portion of X-band typically weigh 12.0 kg (without a power supply and cooling system) and can provide 12.5 to 30 kW from a cylindrical package volume approximately 53 cm \times 12 cm \times 19 cm [53]. Versions built using cathode ray tube technology where permanent magnets are eliminated are less expensive and much lower in mass with a 1 kW coupled-cavity device shown in Fig. 16.

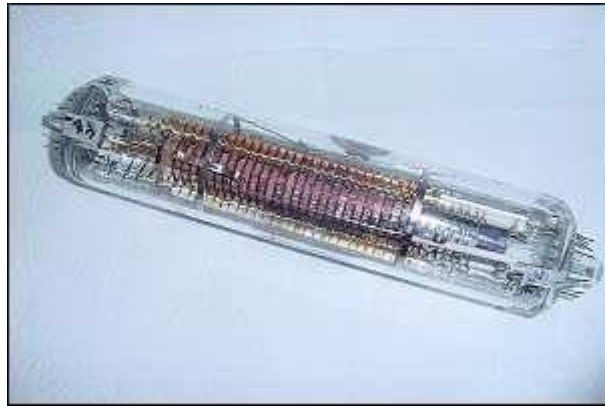

Fig. 16 – A 1 kW electrostatically focused TWT developed by Ebeam [54]

Originally developed by the British and applied to Allied airborne radar systems during the Second World War, magnetrons are the exclusive RF power source employed in microwave ovens. This is due to capability for self-oscillation without an exciter, the straightforward quality control requirements imposed by the simple structure, ease of volume manufacture at low unit cost, relatively high reliability, and long operating lifetime at near beginning of life output power. Because of these characteristics, these devices have also received attention from designers working on proof of concept prototypes for conceptual SBSP systems, but in contrast to the self-exciting units of the original airborne radar and present day oven design, the magnetron tube under development for SBPS application must employ phase-lock technology and amplitude stabilization via feedback. An example of a pulse emitting, high-peak-power ground-based air traffic control radar magnetron is shown in Fig. 17.

Simple phased array pattern measurements with the COMET magnetron system have highlighted the need for very accurate RF power source closed-loop phase and amplitude control to suppress grating lobes to required levels and provide useful beam control [56]. Based on the COMET magnetron-based power conversion module, the Space Power Radio Transmission System (SPORTS) amplifier and antenna array prototype tested by Shinohara and Matsumoto requires that the RF power source provide a frequency stability of 10^{-6} , a phase error of 1 degree, and an amplitude stability of 1% [57]. Depending on both the orbit and power transmitting array structure of the SBSP platform, the requirements for amplitude and phase control of the DC-to-RF power conversion devices are likely to be stricter than in the SPORTS demonstration.

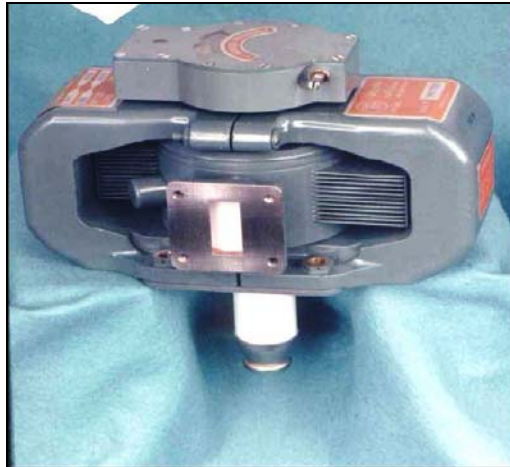

Fig. 17 – The VMX-1090 9.0 to 9.6 GHz 200 kW (peak) magnetron manufactured by CPI [58]

To summarize the key requirements, the RF power source and distribution system must provide a cost-effective amount of launch mass per unit Watt of power generation capacity and the control capacity to satisfy the strict radiation pattern pointing error requirement. To meet this pair of constraints, in the context of a DC-to-RF conversion architecture based on a phase- and amplitude-controlled tube amplifier followed by a power divider and a phase shifter preceding each antenna element in the array, the concept of a “sub-phase shifter” has been proposed to provide fine adjustments required to perform the precision beamforming necessary to maintain optimum power transfer efficiency. This device changes phase over a very limited range spanning of a fraction of a full wavelength, but operates using digital control to adjust the antenna input with much lower power loss than a full 360-degree phase shifter [59].

Power distribution using a high source power per module will encounter design and implementation challenges due to RF power losses in the distribution media, power losses in the phase shifters preceding the antenna elements, and the need for removal and dissipation of RF power converted to thermal energy by ohmic losses. While use of very low power modules (< 500 W) driving small antenna elements can reduce the power amplifier module design difficulty and reduces the concentrated magnitude of power loss in the RF distribution system, it results in a highly distributed, complex system, which is more difficult and expensive to build and a challenge to control. All of the modules must be phase-synchronized and amplitude-leveled as a cohesive group from the standpoint of maintaining the quality of the radiated RF power beam. In summary, there is a trade space between system complexity penalties imposed by a large number of lower power elements and a comparatively smaller number of higher power elements.

An enabling technology within this trade space is the development of interlocking modules with antenna array support plates incorporating the power distribution, power division, “sub-phase” final RF phase adjustment to the antenna element, as well as feed connections to or possibly the antenna elements themselves. The researchers at the University of Kyoto have used this architecture to demonstrate power transfer at 2.45 GHz and 5.8 GHz. The SPORTS system they have under development is an array of “RF power transfer” panels providing DC-to-RF conversion, distribution, control, and radiation functions that serve as an efficient power transmission portal for medium power magnetron tubes with minimum system complexity [60], as shown in Fig. 18.

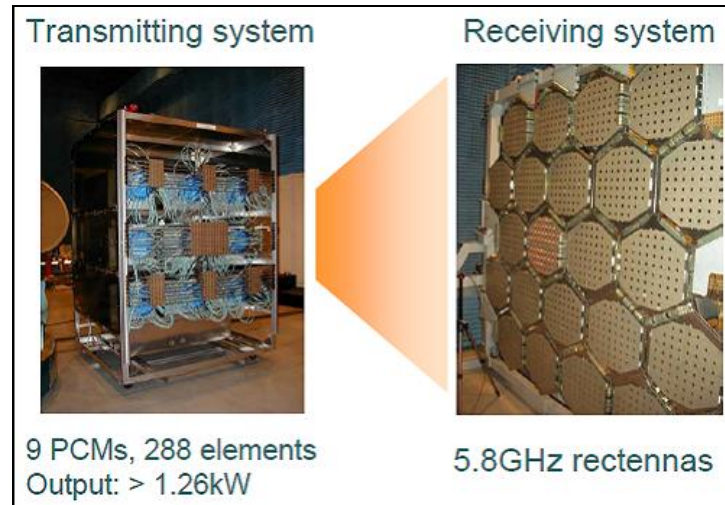

Fig. 18 – The SPORTS 5.8 GHz magnetron DC-to-RF converter and rectenna arrays

Use of high power amplifiers ($>15,000$ W) and antenna elements will face greater design challenges due to the necessity of power transmission using metal waveguide structures. The waveguides and other power components connected to the amplifier output path, such as power dividers and phase shifters, must be carefully designed and tested in order to overcome failure due to multipactor, which “is a parasitic resonant electron avalanche process that occurs in evacuated RF structures” [61]. Multipactor is distinct from corona which is an avalanche-like growth in the plasma electron density at intermediate range gas pressure. Conventional high-power waveguide cannot be used in a vacuum environment without modifications and validation by extensive simulation and testing to verify that it is multipactor free at the desired operating power level plus margin.

Table 6 shows calculated values for standard waveguide where multipactor can be expected to occur if the threshold power is exceeded. Multipactor power threshold is a function of plate spacing and RF signal wavelength. Since the waveguide dimensions are also a linear function of the wavelength of the signal, the multipactor threshold is typically within the 10 to 22.5 kW range. Smaller size waveguide carrying high power levels can be expected to dissipate a significant heat load due to propagation loss. Waveguide intended for a specific SBPS application will require requirements-based analysis and test evaluation to select appropriate geometry, metallic conductors, dielectric fill materials, conductive and/or radiating element thermal control, and possibly coatings to suppress multipactor [62,63] and provide acceptably low mass and RF power loss.

High-power, fast-response phase shifters have been constructed for nuclear particle accelerators using ferrite-loaded planar transmission line and waveguide structures in the 100 to 3000 MHz frequency range at power levels up to at least 1 MW [64,65]. Unfortunately, these devices are extremely large and heavy and use high-current electromagnets to achieve phase control, so they are not suited to spacecraft application.

Table 6 – Multipactor Threshold for Standard Waveguide Calculated with ESA/ESTEC Multipactor Calculator Version 1.6

Waveguide Designator	Outer Dimensions (Inches)	Frequency (GHz)	Maximum Power Transfer in Air (MW)	Multipactor Threshold (kW)
WR-430	4.460 × 2.310	2.45	11.6	20
WR-187	2.000 × 1.000	5.80	2.1	20
WR-62	0.702 × 0.391	18.0	0.16	22.4
WR-28	0.360 × 0.220	30.0	0.024	10.0
WR-12	0.202 × 0.141	90.0	0.006	22.4

A more promising technology for planar phase shift structures that has entered initial production is based on the change in dielectric constant of a complex dielectric oxide film. The nGimat Company is advertising Barium Strontium Titanate (BST) thin film phase shifters that are voltage-controlled over a 0 to +20 VDC range. These devices are readily compatible with state-of-the-art planar phased array antenna elements operating in S-band. “A complete beamforming network consisting of a power splitter and two phase shifters has been constructed at the Georgia Institute of Technology to test the functionality of the device in the field” [66]. The planar, voltage-controlled phase shifter represents an essential enabling technology for implementation of the RF power transfer panels described above. Further design evaluation leading to possible testing would be highly beneficial to investigate the power handling capability and limit of the BST planar phase shifter and to determine the material compatibility with conditions in the space environment, suitability to address RF power transfer panel design constraints, and capability to meet reliability and functionality goals derived from SBPS RF system requirements.

There are system performance and reliability issues unique to a long-lifetime, very large investment power generating system situated in a remote part of space from the standpoint of zero human maintenance. In the DC-to-RF conversion system, noting the possibly dependency on the SBPS architecture, these issues are:

- Emergency shutdown and/or de-phasing of DC-to-RF conversion system elements in the event of SBPS platform pointing error, frequency misadjustment, or other major system failure.
- Real-time monitoring of antenna element radiated power to support beam quality maintenance adjustments that strictly confine RF power flow to desired target area.
- Accurate and very fine adjustment of antenna element RF drive power phase and amplitude to maintain beam pattern quality, sidelobe suppression, and pointing accuracy.
- Closed-loop control of power amplifier unit phase and amplitude to sustain performance during normal operation and protect against failure scenarios involving short circuits due to electrical failure, mechanical damage, excessive temperature, and multipactor events.
- Level of redundancy required for power amplifier elements to assure system operating lifetime requirements are met with desired probability of survival.

Suggestions for research areas needing investigation within the DC-to-RF conversion technology area:

- Evaluation of state-of-the-art electron tube designs to provide moderate to high RF power levels (2.5 to 25 kW) with reasonable cost, the lowest possible launch weight, and reliability and operating life that satisfies the projected SBPS requirements.

- Wide array area distributed monitoring and control of active element RF power phase and amplitude for beam quality maintenance.
- Investigation of materials and geometry for high-power capacity, very-lightweight, low-loss, multipactor-free waveguide that can sustain reliable operation in vacuum at high power levels higher than 15 kW.
- Development and testing of very low loss, compact, and lightweight antenna element input “sub-phase” control devices, which could possibly be based on complex oxide technology such as BST, where the dielectric constant changes as a function of the applied voltage.
- DC-to-RF power conversion system component development should focus on the 2,000 to 15,000 W power amplifier unit as the most likely design increment useful to development of a SBSP demonstration system from the standpoint of development manageability, utility, and cost-effectiveness.

3.4.4 DC-Optical Conversion

Transmission of laser power from SBSP via lasers is an alternative to the microwave transmission approach. The advantage to this approach is that it presents the possibility of a much smaller system both on-orbit and on the ground. However, reduced aperture sizes necessarily result in higher power densities, which in turn pose eye safety hazards and possible geopolitical concerns. A significant drawback is that cloud cover affects propagation to the ground, and thus reliable transmission for a given site on a given day cannot be guaranteed. Another major drawback is that the tolerances on all the physical dimensions, such as thermal expansion and laser component alignment, are very tight because much smaller wavelengths are employed.

The receiving site on the ground for a laser-based system might only need dimensions on the order of about 100 m as compared to over 1 km. The structures required in space may also have smaller dimensions, however operation of high-powered lasers in space presents its own set of technical issues to overcome. Reducing the size of the receiving site on the ground beyond a certain limit will result in the eye safety issues associated with coherent radiation transmission. Presently, eye safety concerns will limit the optical power density on the ground. The highest power density allowed is in the 1550 nm spectral range, where 100 mW/cm² is considered eye-safe without aided viewing. This level is about the same energy density as the Sun at AM0, however, laser radiation does present a greater eye hazard than solar radiation due to its coherence.

Most feasibility studies for SBSP using optical transmission have suggested using 1060 nm transmission due to the higher efficiency of the lasers in this spectral region. However, the eye-safe transmission level in this region is 100 fold lower at 1 mW/cm². This would prohibit any potential use of 1060 nm for SBSP without waiving current safety requirements. For this discussion, it will be assumed that technology will need to focus around 1550 nm instead of 1060 nm.

The supporting technology for using high-powered lasers is not as mature as microwave transmission, and so microwave-based space power concepts have typically been better developed. However, because of the potential advantages of a laser-based system as well as a general maturation in laser technology over the last several decades, there has been a recent resurgence in the published literature with regard to laser-based system design. Organizations such as the Japan Aerospace Exploration Agency (JAXA) are giving it significant attention [67], as well as a number of papers out of the University of Alabama Huntsville and NASA Marshall [68].

In general, operation of conventional lasers, gas and crystal-based, is very inefficient. Very little of the energy input excites the lasing medium and most of the energy escapes or is converted into heat. Typical efficiencies are on the order of a few percent or less. For this reason, the idea of operating high-power lasers using the electricity from solar cells in space has been seen as impractical, at least in comparison to using microwave power transmission. Despite this, the DARPA SHEDS program [69] is

pushing for diode lasers with 80% wallplug efficiency with operating wavelengths from 880 to 980 nm. The efficiency degrades at longer wavelengths, but 60% is likely obtainable. Due to their limited brightness and beam quality, the biggest challenge with this technology is in power scaling or array techniques. The ability to scale efficiency to above 50% is beyond current technology. An alternative to extremely high power would be to use the highest efficiency diode laser to pump a solid state laser design.

It seems logical that higher efficiencies might be realized if the lasers are pumped directly, where concentrated sunlight is used to excite the laser gain material. Several very simple demonstrations of direct solar-pumped lasers have been performed. Saiki et al. [70] used a quasi-solar lamp and achieved optical-optical efficiencies around 33%. Yabe et al. [71] used simple Fresnel lenses and achieved up to 14% efficiency with a Cr-doped Nd:YAG ceramic. Fig. 19 shows the Yabe et al. experiment.



Fig. 19 – Example of simple demonstrations of direct solar pumped lasers [71]

Fundamentally, direct solar pumping can not exceed the efficiencies of single junction solar cells without taking advantage of multi-electron/photon per photon processes. Similar to the process within a single junction solar cell, an absorbed photon decays (via a phonon process leading to heat) to the lasing state where it can be emitted. The energy output is fixed per photon (one photon in gives one photon out at best). This makes efficiency in emission at 1550 nm challenging as most of the solar spectrum is below 1000 nm, resulting in a high quantum defect. A potential solution to this issue involves processes that emit more than one photon per photon absorbed, such as cross relaxation (typically very narrowband spectral absorption) or quantum cascade laser designs.

3.4.4.1 Technology Focus Areas

Phillips et al. [71] lay out areas where major technical advances need to be made to significantly further laser-based SBSP. Paraphrasing a bit, these can be grouped as: (1) solar concentrator design; (2) laser design including thermal management; and (3) laser power beaming receiver design. Items (1) and (2) are discussed in this section. Their paper addresses the Earth—Moon system, such as providing power to remote lunar bases, but these are also the key areas to address for beaming power to the surface of the

Earth. These topics are also technology areas where NRL has the expertise and facilities to make fundamental contributions.

It should be noted that in almost all of these areas, a good deal of the published work is based on modeling and design. Some are new concepts that are modeled very thoroughly [72], while others are based on more conventional systems but are scaled up in size and energy [73]. In many cases, significant technological advancement can be made at relatively modest investment by moving some of the designs into experiments to encourage progress as well as test design assumptions.

3.4.4.1.1 Solar Concentrator Design

Regardless of the SBSP approach used, solar concentrators will be needed, whether they are for solar-pumped lasers or solar array panels. Figure 20 shows two concepts for light concentration onto lasing materials.

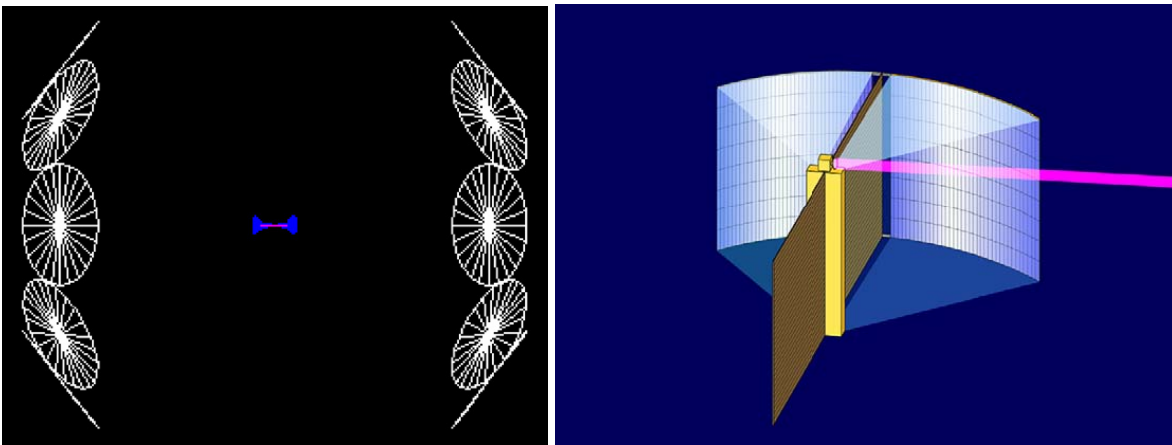

Fig. 20 – Two ideas proposed for solar collectors to concentrate light onto a lasing medium. The left image, from Phillips et al. [60] uses separate mirrors (shown in white) to concentrate light into the two non-imaging collectors (shown in blue), which further concentrate the light onto a laser crystal (magenta). The right image, from Mori et al. [67] shows a 10 MW system made up of two 100-m \times 100-m mirror arrays concentrating light onto a Nd:YAG crystal.

Solar concentrators will require potentially large structures holding thin membrane reflective materials. NRL has specific expertise in this area, which is described more fully in the Space Structures Technologies section of this report. To help prevent the generation of unnecessary waste heat, the reflective surfaces should selectively reflect wavelengths of interest, i.e., reflect only the wavelengths needed to pump the laser crystal.

3.4.4.1.2 Laser Design

Efficient beam propagation occurs with high quality laser beams, which are beams with low-order Gaussian modes. These modes are achieved with stable, well-designed resonator cavities. The dimensions of the resonator are related to the output power of the laser. Ultimately, the laser design, and hence the system efficiency, drives the design of the whole system. The laser design and infrastructure for a single 1 MW laser will be much different than a 1 MW system built out of 100 10 kW lasers.

Laser-based systems share many thermal control issues with microwave-based systems with the generation of a lot of heat in concentrated areas that needs to be radiated into space. Heat removal is of particular importance to the laser approach because not only can accumulated heat cause component or structural failure, but also excessive heat in the laser crystal will cause the crystal to change performance

or fail outright. Excess heat can cause thermal lensing, or it can stress the crystal resulting in the creation of birefringence or fracture. Thermal management for this section is defined narrowly to refer only to removal of heat from the laser gain material.

The thermal management approach ultimately depends upon the design of the laser itself. Conventional laser design generates coherent light using a confocal resonator. To generate the best beam quality, which is obtained from the lowest order Gaussian mode, the laser gain material usually takes the form of a long, slender tube. This geometry does not scale up well because the tube becomes very long, and removal of heat becomes very difficult as the laser power is likewise scaled. As heat is removed out the side of the tube, radial thermal gradients are established that can change the optical properties of the material and reduce beam quality. An example of a concept to avoid this is taken from Fork et al. [75] and is shown in Fig. 21.

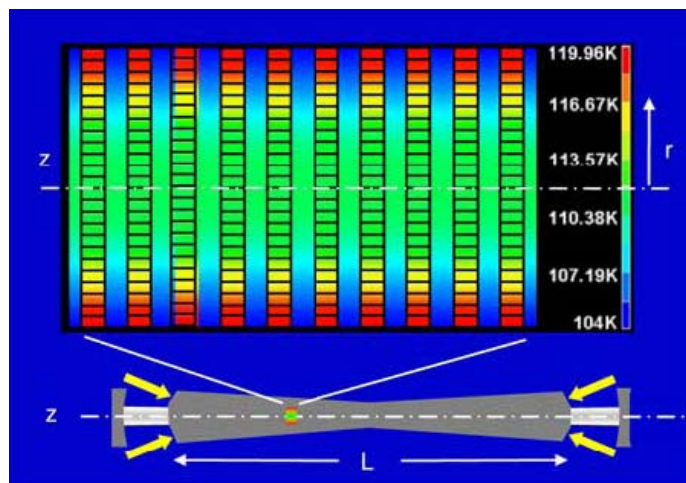

Fig. 21 – An example of a laser gain medium designed to remove large amounts of heat without affecting the laser performance [75]

A design for a high power laser in space will necessarily be unique or innovative. NRL, either on its own or partnering with the groups active in this area, has excellent resources for working with and designing high power lasers and would be capable of contributing to innovative laser design or construction.

3.4.4.1.3 Laser Pointing

As a strawman for determining SBSP laser pointing requirements, a 5 MW class design may be assumed. Assuming that 60% band edge efficiency conversion cell on the ground is achievable in the 1550 nm window, this requires 8300 kW of optical power on the ground. At 100 mW/cm² maximum power density, the minimum beam diameter is 100 m. To focus a spot this small on the ground from GEO (35,000 km) requires a pointing accuracy of 1.4 μrad in the diffraction limit. This would require a diffraction limited optic of $2.44\lambda/1.4 \mu\text{rad} = 2.7 \text{ m}$ in diameter. As a point of reference, the Hubble Space Telescope has a 2.4 m optic with a 40 nrad short term pointing accuracy, however, that optic does not need to handle significant power. The optic for this application would be required to handle 10 MW and maintain the diffraction limit. This is a difficult challenge given the heating and beam distortion issues in high power optics.

3.4.4.2 Potential Areas for NRL Participation

- High-power quasi-CW laser demonstration
- Large solar collectors, preferably made out of materials that reflect only the wavelengths needed to pump the solar lasers
- Demonstration of operation of separate but cooperative solar collectors from free-fliers or boom structures

3.4.4.3 Potential BAA or SBIR/STTR Topics

Much of the work done for laser-based SBSP has been design development and modeling, or small-scale experiments, and there is work that can continue to be done at this level of investment. Some areas that may be good topics for internal research or Broad Agency Agreements (BAA) or Small Business Innovative Research (SBIR)/Small Business Technology Transfer (STTR) topics include the following:

- Development of innovative lasing materials (such as using Cr³⁺ doping) for direct solar pumping
- Development or implementation of laser gain material thermal control
- Solar collector optical design
- Solar collector wavelength-specific reflective membrane material development

3.4.5 Power Transmitting Antenna Systems

The transmit array for an SBSP microwave system will operate with a Gaussian beam profile to allow for efficient wireless power transmission. In addition to generating a tapered beam, the transmitting array will be required to maintain accurate beam alignment with the rectenna located on Earth for reasons of safety and efficiency [73]. Presumably, the beam alignment will be maintained by implementing retrodirective beam control. Retrodirective beam control requires the transmitting array to receive a pilot signal originating at the receiving antenna. This pilot signal is then conjugated – either using an active or passive network – with a reference signal to determine the necessary phasing to maintain precise beam pointing accuracy. To maintain control over the element amplitude and phase distribution across the extremely large array, an in situ calibration technique will need to be integrated to the array structure.

As described in the discussion on wireless power transfer found in Appendix C, the radiating aperture will be extremely large at the commonly discussed ISM band frequencies of 2.45 and 5.8 GHz. It is critical to maintain extremely tight surface tolerances over the entire surface of the array. As a result, it may be advantageous to divide the large transmitting array into smaller subarray structures that can be phased properly to form narrow beams individually [74]. Mechanical control of subarray alignment may be required to maintain necessary beam accuracy.

Circular polarization (CP) is ideal for long range wireless power transmission because it eliminates the need to maintain polarization alignment between the transmitting and receiving arrays. Microstrip patch antennas with perturbed opposing corners have been shown to be efficient, low cost radiating elements for providing CP operation with a single feed point [75-77]. This type of element would be an ideal radiator for the extremely large transmitting aperture by limiting the cost and weight of the overall structure.

3.4.6 Rectenna Systems

The receive aperture in space-based solar power systems using microwave power transfer will be an extremely large array of rectifying antennas (rectennas). Figure 22 is a schematic view of a rectenna. The

incident wave is received by the antenna and coupled to the rectifying circuit. In this case, the rectifying circuit is indicated as a single diode. Other rectifying circuits such as 16-diode bridge rectifiers [78], Schottky diodes [79], dual-diode circuitry [80] have been shown in the literature. The selection of the proper rectifying circuit is usually based on the incident power density and operational frequency range. The output of the rectifying circuit passes through a low pass filter (LPF). The LPF is present to restrict any RF energy from flowing into the power management circuit. The controller circuitry enables the energy storage and the delivery of the output DC energy [81].

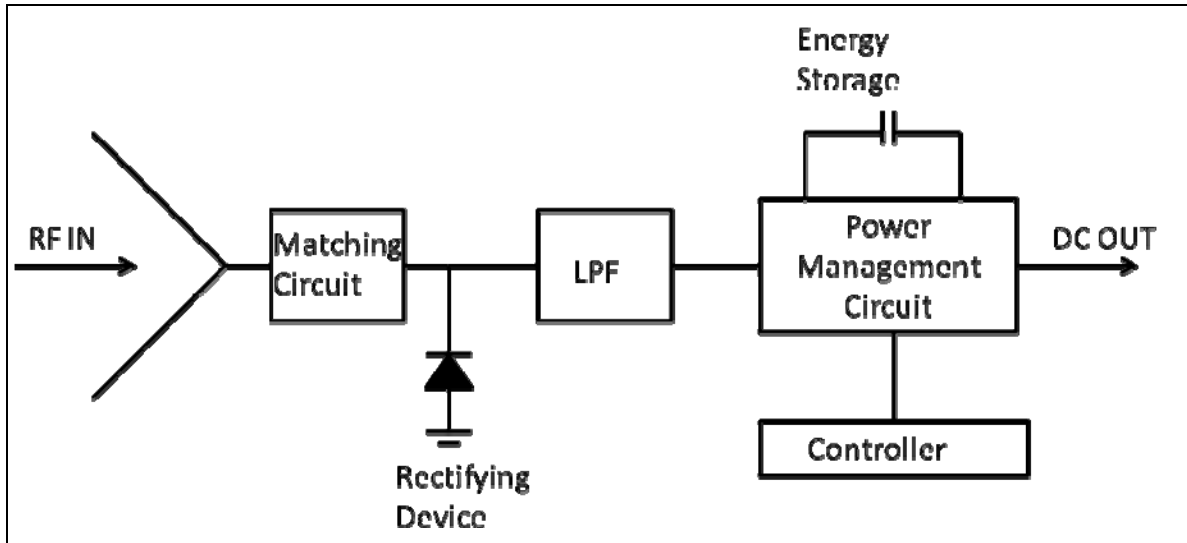

Fig. 22 – Schematic of rectenna and associated power management circuit
(figure taken from Ref. 81)

The average RF power over the operational frequency range of the rectenna at a given instant in time is given by (1). The RF power received by the antenna is a function of the incident power density (S), effective area of the antenna (A_{eff}), incidence angle, and frequency. The DC power can be calculated from (2), and it is seen to be a function of the RF power, conversion efficiency (η), and the DC load impedance (Z_{DC}). The conversion efficiency is known to be a function of the input RF power. Therefore, fluctuations in the incident power density will alter the conversion efficiency – and subsequently the output DC power – of the rectenna [81].

$$P_{RF}(t) = \frac{1}{f_{high} - f_{low}} \int_{f_{low}}^{f_{high}} \int_0^{4\pi} S(\theta, \varphi, f, t) A_{eff}(\theta, \varphi, f) d\Omega df \quad (1)$$

$$P_{DC} = P_{RF}(f_i, t) \eta(P_{RF}(f_i, t), \rho, Z_{DC}) \quad (2)$$

The elements in this rectenna should support circular polarization (CP) to eliminate the need to maintain alignment with the electric field polarization of the transmitting antenna [80]. Circularly polarized rectenna arrays have been discussed in the literature, and they have been shown to provide high conversion efficiencies in small arrays [82,83,80,84]. Antenna elements such as microstrip patches, rings, and slots with perturbations can be utilized in rectenna arrays to provide CP operation with a single feed

point. The microstrip design provides a cheap, low profile, and lightweight design that allows convenient integration of the necessary rectifying circuitry.

For SBSP applications, the transmitting antenna will operate with a Gaussian beam profile in order to achieve high power transfer efficiency (see Appendix C). This will require the rectenna to maintain high conversion efficiency with non-uniform power densities across the elements in the array. It has been shown that modifying the diode string at each element can optimize the rectification efficiency at each element [81]. However, this optimization increases the number of unique elements within the array, thus increasing cost and complexity.

Rectenna elements can be placed in a non-uniformly spaced array to generate a flattened, broad beam that can mitigate the importance of precise, accurate beam pointing [85]. However, this beam flattening introduces decreased overall gain and increased complexity. The reduction in gain is undesirable in SBSP since maximizing the system efficiency is critical. Therefore, a retrodirective beam control approach should be implemented to maintain precise beam alignment between the transmitting array and the rectenna array. This approach requires the rectenna to have a radiating aperture and accompanying electronics necessary for generating a pilot signal that will be received and processed at the transmitting antenna.

3.4.7 Optical Receivers

The obvious approach to an optical receiver design for SBSP is to use solar cell technology to convert the optical beam photons directly into energy. Since the transmitting beam is a laser, the receiver cells can have their band gaps tuned for the laser and thus increase the conversion efficiency. According to JAXA, a solar cell with a band gap tuned for a 1.06- μm laser has a theoretical 70% conversion efficiency. Long wavelength (1550 nm) devices would also need to be demonstrated to allow for eye safe operation. Recent measurements of high concentration photocells in NRL Code 5650 suggest that greater than 60% is achievable in this spectral regime.

Another approach to optical receiver conversion that is under study by the Japanese is instead of converting photons to electricity via solar cell, the photons can be used directly to create hydrogen by water disassociation, or to store the energy in a reservoir. It is not clear whether these innovative approaches are in the interest of the Navy, because this would require a conversion in at least some vehicles or infrastructure to use hydrogen.

3.4.8 Terrestrial Power Conversion and Control

The energy that is brought down and then converted from RF to AC needs to go either into the grid for immediate consumption or into storage for use later or for use in other areas. A LEO application would not be considered “reliable” power since the power is only delivered to the grid sporadically without constellation coverage. A GEO application has problems because it would need to have a way to throttle the power coming in if there wasn’t demand for that energy. The spacecraft would not be able to throttle either due to complexity of making moves of large structures or thermal overload problems due to the extra power dissipated in the spacecraft. The grid works off of a “just in time” approach, where users and generators are balanced. Major problems exist when one side is out of tune with the other.

The likely use for this energy, in either LEO or GEO, would probably wind up being used for load leveling applications – maybe in conjunction with a terrestrial solar or wind farm, both of which are also considered to be “not reliable” due to peaks and valleys of the energy source. In many respects, this approach makes a lot of sense as no one approach alone is reliable, but in combination with each other or additional technologies, they might augment each other. For example, significant efforts have been made pursuing terrestrial and space-based electrolyzers, fuel cell technologies, and anhydrous ammonia production for load leveling. In this scenario, extra peak capacity is stored as chemical energy, and removed as needed by way of a second chemical conversion process. NRL led an integrated product team

for a DARPA technology program for space-based hydrogen/oxygen systems using water as the working fluid [85].

A second approach would be to store the extra unused energy for use either later (peak power load leveler) or in a different location (distributed power). The peak load leveler would need a large scale storage system that could accept all the energy and then distribute high power for short time periods (middle day hours in summertime, early morning/evening hours in winter, pre-/post-rush hour if plug-in electric cars become standard). The distributed power would be using multiple versions of a portable storage system, such as an energy storage device the size of an 18-wheeler truck trailer that could charge and then disconnect from the rectifier distribution system. The trailer would then be transported to where it was needed to act essentially as a localized power source – most likely in a back-up mode or special application. These two approaches could also be combined together to work in tandem.

3.4.9 Energy Storage

Large-scale energy storage is an area of intense research these days due to the increasing interest in non-traditional sources of energy (e.g., wind and solar). These sources are intermittent in their ability to supply energy, and hence, energy storage provides the ability to accumulate energy during the collection times to provide a uniform energy delivery over long time periods [86].

Some SBSP schemes for defense applications, particularly those in LEO, might require storage capabilities. In any situation where the power is not consumed immediately, storage in some form must be employed.

Many of the charts included in Figs. 23 through 31 are taken from the “Technology Comparisons” section of the website of the Energy Storage Association, and can be found at http://electricitystorage.org/tech/technologies_comparisons.htm [86-89]. They are reproduced here for completeness.

Storage Technologies	Main Advantages (relative)	Disadvantages (Relative)	Power Application	Energy Application
Pumped Storage	High Capacity, Low Cost	Special Site Requirement		●
CAES	High Capacity, Low Cost	Special Site Requirement, Need Gas Fuel		●
Flow Batteries: PSB VRB ZnBr	High Capacity, Independent Power and Energy Ratings	Low Energy Density	◐	●
Metal-Air	Very High Energy Density	Electric Charging is Difficult		●
NaS	High Power & Energy Densities, High Efficiency	Production Cost, Safety Concerns (addressed in design)	●	●
Li-ion	High Power & Energy Densities, High Efficiency	High Production Cost, Requires Special Charging Circuit	●	○
Ni-Cd	High Power & Energy Densities, Efficiency		●	◐
Other Advanced Batteries	High Power & Energy Densities, High Efficiency	High Production Cost	●	○
Lead-Acid	Low Capital Cost	Limited Cycle Life when Deeply Discharged	●	○
Flywheels	High Power	Low Energy density	●	○
SMES, DSMES	High Power	Low Energy Density, High Production Cost	●	
E.C. Capacitors	Long Cycle Life, High Efficiency	Low Energy Density	●	◐

- Fully capable and reasonable
- ◐ Reasonable for this application
- Feasible but not quite practical or economical
- None Not feasible or economical

CAES = Compressed Air Energy Storage, using large underground caverns

SMES = Superconducting Magnetic Energy Storage

DSMES = Downsized SMES

NOTE: NRL has previously flown a sodium sulfur (NaS) battery in space as part of the NaSBE project.

Reference: http://electricitystorage.org/tech/technologies_comparisons.htm

Fig. 23 – Capabilities of various energy storage technologies. *Power Applications* refer to short-term energy supply for “demand leveling”; *Energy Applications* refer to long-term energy supply at lower power levels.

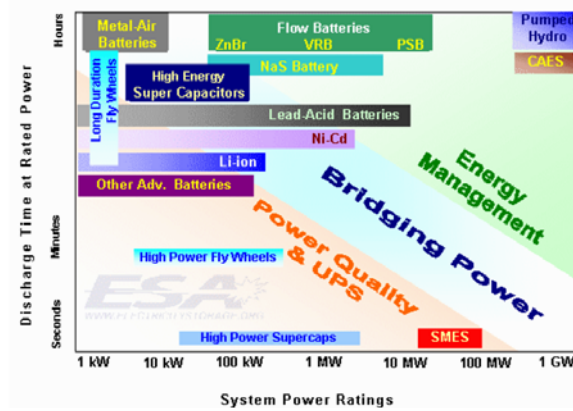

Fig. 24 – Various energy storage technologies optimally supply electrical energy at a range of discharge rates. *Power Quality & UPS* refers to energy storage sources that can deliver low-to-high power for use in load-leveling over short time periods. *Bridging Power* refers to energy storage sources that can deliver low-to-medium power levels for use in covering demand during the switch from one to another power source. *Energy Management* refers to energy storage sources that can deliver low-to-high power levels for use in covering demand over long time periods.

Reference: http://electricitystorage.org/tech/technologies_comparisons_ratings.htm

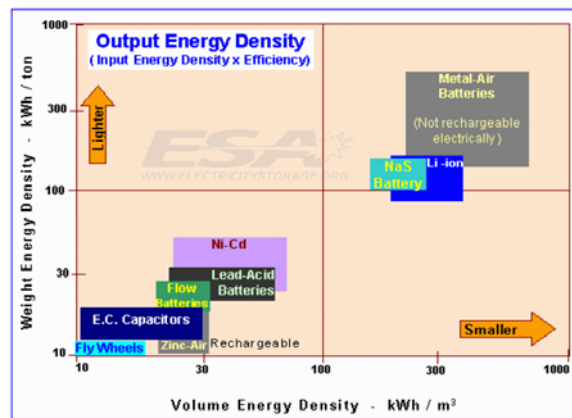

Fig. 25 – Energy storage capacity of batteries, capacitors, and flywheels normalized by mass and volume. The metal-air primary cells (non-rechargeable) show the best performance for batteries.

Reference: http://electricitystorage.org/tech/technologies_comparisons_sizeweight.htm

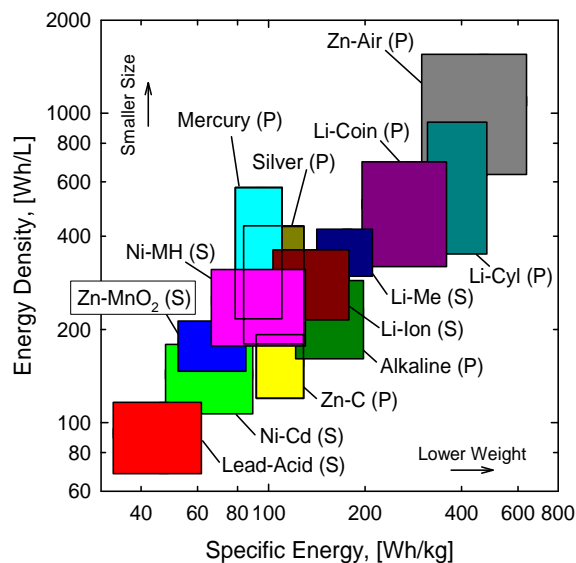

Fig. 26 – Energy storage capacity of various primary (non-rechargeable) and secondary (rechargeable) batteries normalized by volume and mass [90]

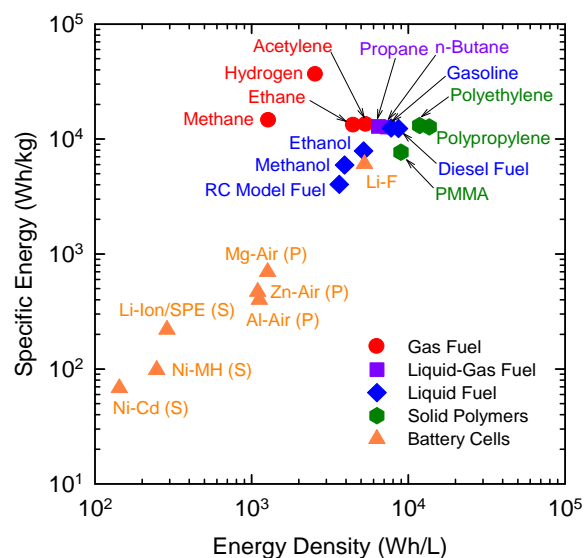

Fig. 27 – Energy storage capacity for a wide variety of energy storage materials normalized by volume and mass. The hydrocarbon materials and polymers have much larger energy storage capacity relative to that of battery technologies. Hydrogen has the highest energy/mass and polypropylene the highest energy/volume. The LiF electrochemical couple has the theoretical maximum battery energy [90].

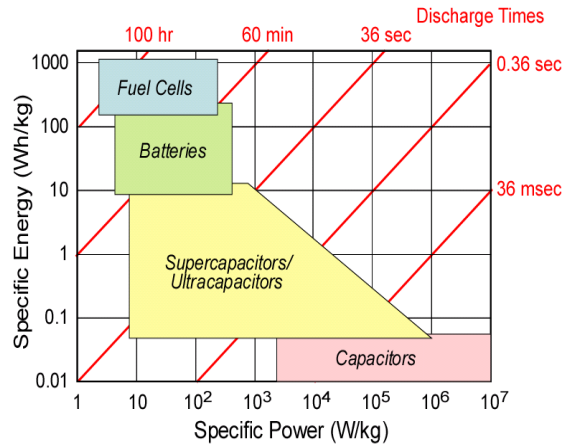

Fig. 28 – Ragone plot showing specific energy storage capacity vs specific discharge power for various electrical energy storage devices [90]

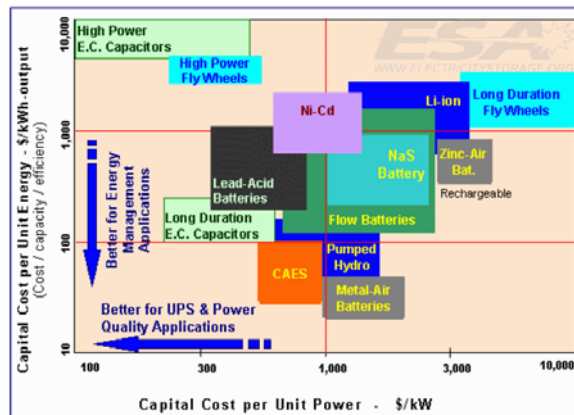

Fig. 29 – Capital cost/energy vs cost/power (without including power conversion costs) showing how the various energy storage technologies compare (based on prices in 2002).

Reference: http://electricitystorage.org/tech/technologies_comparisons_capitalcost.htm

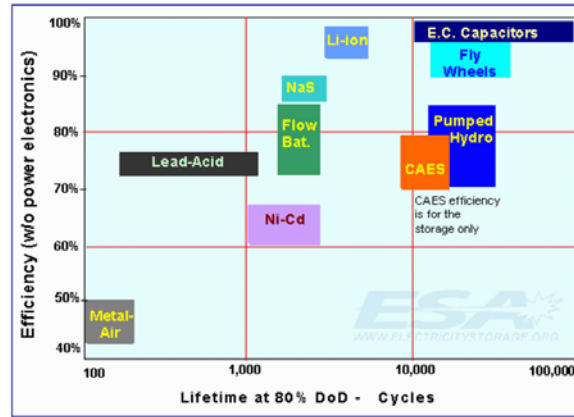

Fig. 30 – Energy delivery efficiency vs lifetime for 80% “Depth-of-Discharge.” Battery technologies exhibit lower lifetimes (100s to 1000s of discharge cycles) compared to capacitors and the other “mechanical” energy storage technologies. Reference: http://electricitystorage.org/tech/technologies_comparisons_lifeefficiency.htm

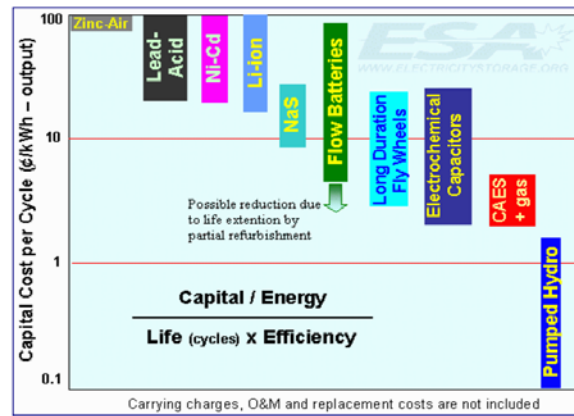

Fig. 31 – Cost per discharge cycle at a given power level, accounting for efficiencies and lifetimes, for energy storage technologies. This data is primarily applicable to load-leveling applications. Again, capacitors and mechanical energy storage technologies perform well under this metric.

Reference: http://www.electricitystorage.org/tech/photo_percyclecost.htm

4. RELEVANT RESEARCH AREAS

4.1 DC-to-RF Conversion

A key enabling technology for SBSP is the conversion of DC power from photovoltaic cells to a form that can be beamed to Earth. As discussed above, the most relevant frequencies for this wireless transmission are microwaves below 10 GHz, millimeter waves at ~94 GHz, and laser wavelengths in the IR. Although each potential operating frequency has its own advantages and disadvantages, any selected technology must be designed for high conversion efficiency, light weight, and long life in the space environment. Thermal management is very important and must be incorporated in the design. Although converters exist in each of these frequency ranges, some of them even space qualified, significant performance enhancements are required to tailor them to this application.

NRL's Electronics Science and Technology Division (Code 6800) is a world leader in the development of microwave and millimeter wave amplifiers that can be optimized for the SBSP mission, with a long history of development and application of both vacuum electronic and solid state devices. The Division has developed powerful physics-based modeling and design tools and has used these tools, often in close collaboration with U.S. industry, to develop new classes of amplifiers carefully tailored for specific applications. For example, NRL researchers have been instrumental in the development of compact, high-power, high-efficiency TWTs, gyrotrons, and multiple-beam klystrons (MBKs) for applications such as electronic warfare, radar, and high-data-rate communications. Vacuum electronic devices have spanned the frequency range from 2.5 to 94 GHz with power levels from ~1 kW to hundreds of kW. With internal 6.1 and 6.2 funding and with outside funding from ONR and DARPA, NRL is continuing to advance the state-of-the-art in these technologies. Ongoing development projects include a 3-GHz MBK, coupled-cavity and helix TWTs in the 18 to 40 GHz range, a permanent-magnet-based harmonic gyrotron at 94 GHz, and new sheet-beam technology that will enable higher power, more compact devices throughout the millimeter wavelength range. Thus, NRL is well-positioned to apply its expertise for the development of highly optimized DC-to-RF converters for SBSP applications.

4.2 Microwave Power Beaming

4.2.1 Retrodirective Beam Control

Many concepts will need to manage the calibration system for an electronically steered power transmission array and handle the retrodirective beam steering system. The system will need to be able to adjust the amplitude and phase of all modular panels. The calibration is necessary to generate and maintain the proper beam shape and pointing accuracy.

The rectifying antenna, or rectenna, is a critical component of any wireless power transmission network. The rectenna array will receive the microwave energy and convert it into DC power. It consists of an antenna array, input filter network, rectifying circuit, and an output filter [78]. In order to maintain the maximum transmission efficiency, retrodirective rectennas are desirable due to their ability to maintain main-beam alignment between transmit and receive antennas [91]. Maintaining precise beam pointing accuracy is extremely important in establishing high transmission efficiency in the transmission of wireless power transmission from space. There are multiple techniques used for implementing a retrodirective array. These techniques involve a pilot signal being sent from the receive array (in this case the rectenna array) back to the transmitter.

In the Van Atta approach, pairs of elements that are equidistant from the center of the array are connected with transmission lines. The signals received by the array are then re-transmitted but with the elements in the array flipped. This technique performs retrodirectivity over a wide bandwidth, and it does not require any active components. However, this approach is limited to receiving plane waves only [92]. Since the SBSP wireless power transmission would require a Gaussian-type beam, the Van Atta approach would not be applicable. An illustration of this approach is shown in Fig. 32(a) [92]. Another approach uses phase-conjugating mixers as shown in Fig. 32(b) [92]. In this approach, the received signal is

conjugated and a signal is reradiated towards the source. This type of approach typically requires a mixer circuit with a large frequency difference between the RF and LO frequencies and the RF leakage must be minimized [79].

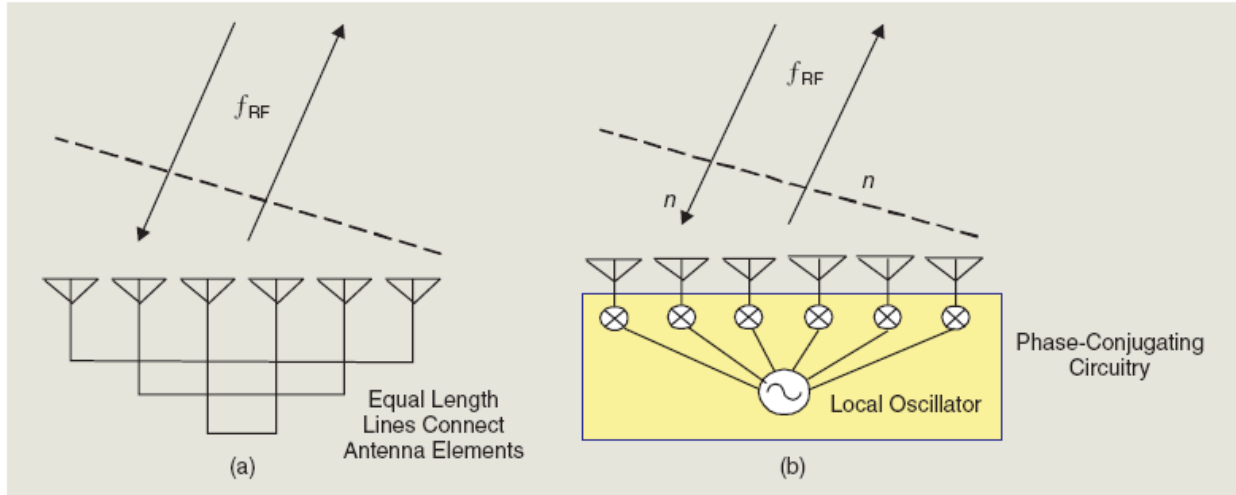

Fig. 32 – Retrodirective approaches (a) Van Atta approach (b) phase-conjugating approach (figure taken from [81])

In order to maintain beam pointing precision with a large rectenna, significant research would need to be performed in this area. The feasibility of implementing each retrodirective technique into an extremely large rectenna array will need to be investigated. In addition, the frequency, polarization, and power level for the pilot signal will need to be determined as well. If the technique involving active components is selected, the generation of intermodulation frequencies will need to be studied, and a frequency selective surface (FSS) may need to be integrated into the arrays to filter out the generated harmonics [79].

4.2.2 Transmit Amplitude Weighting

Establishing the appropriate amplitude and phase taper in the large transmitting array required for space-based solar power (SBSP) is a challenging task. Many array applications achieve an amplitude taper by placing attenuators behind each element in the array; this type of amplitude weighting technique essentially absorbs energy via attenuation at each element. In SBSP, using attenuators for the application of amplitude taper would further decrease an already-low overall system efficiency. Other techniques need to be investigated for shaping the transmit beam. One interesting technique is the use of shaped solar reflectors to provide a taper in the amplitude of the incident solar energy which would then correspond to a taper in the RF energy. This has been proposed in the Modular Symmetrical Concentrator architecture.

More efficient power transmission can be realized if the antennas are operated in the Fresnel region. This allows the transmit antenna to be focused on the receive aperture instead of being focused at infinity. This is accomplished by introducing a quadratic phase profile across the array, resulting in the distribution shown in Eq. (3). The amplitude distribution in Eq. (4) is left as $f(r)$. There have been studies on optimizing the amplitude taper to maximize the power captured at the receive antenna by minimizing the sidelobes of the transmit antenna [93,94]. Many of the studies on the amplitude tapers have shown that the optimized amplitude tapers are essentially Gaussian [95,96].

$$E_t(r) = f(r)e^{j\frac{k}{2d}r^2}, 0 < r \leq r_t \quad (3)$$

The Gaussian amplitude taper is defined by the σ value of the distribution. This value determines the illumination at the edge of the array (assuming a circular aperture). Previous work has shown that a -10 dB Gaussian taper can provide efficient energy transmission between geostationary orbit and Earth [97]. After the σ value is selected, the transmission efficiency can be calculated from Eq. (4), where c is the Fresnel number defined in Eq. (5) [98].

$$\eta = \frac{16\sigma_t\sigma_r c^2}{(1-e^{-2\sigma_t})(1-e^{-2\sigma_r})(4\sigma_t\sigma_r + c^2)^2} \left[1 - e^{-(\sigma_r + \sigma_t)} \left\{ \sum_{i=1}^2 \sum_{q=0}^{\infty} \left(\frac{2\sigma_i}{c} \right)^q J_q(c) - J_0(c) \right\} \right]^2 \quad (4)$$

$$c = \frac{kr_r r_t}{d} \quad (5)$$

4.2.3 Modularity Studies

Among many things identified as requirements in the National Security Space Office Interim Assessment Report on SBSP (2007), were that “construction simplicity must be maximized” and “hyper-modular space systems, in-space assembly, maintenance and service are required.”

For these same reasons, NRL’s Spacecraft Engineering Department conducted the seminal study of spacecraft modular design [99] that eventually led to DARPA’s current “Orbital Express” program. The purposes of modularity include minimization of parts count and ease of on-orbit repair and upgrade (see Section 4.6 below).

A unique NRL contribution to modularity is provided by its large-space structure system, which is described in Section 4.6.1. All structural support systems can be made either of a deployable truss beam or an isogrid tube, so there are only two attachment systems needed. Both structural systems are deployed by mechanisms that can, after deployment, walk along the structures to transport and integrate hardware and make repairs.

The transmit and receive arrays will both require amplitude and phase weighting to operate in the Fresnel region necessary for high efficiency wireless power transfer. Depending on how the weighting is to be achieved, it may become necessary to have different modules in different locations of each array. The greater the number of module designs, the greater the complexity – and cost – of the array becomes. However, increasing the number of different module designs can also offer greater flexibility in the overall array design. This presents a tradeoff between the cost of the array and the flexibility in the performance.

A modular design greatly simplifies the construction of the arrays, but it also presents other challenges. The decision on the number of elements present in each module presents another tradeoff. The greater the number of elements in each module, the simpler the assembly will be. However, when a component needs to be replaced, the entire module will also be replaced. Consequently, a larger module size results in a greater replacement cost. The size of the module should be investigated to find the optimal module design. Questions that require further study include:

- Is it better to have all panels in the array be identical?
- Or, is it better to use different modular panels for different sections of the array?
- For microwave power transmission, the array likely needs to have an amplitude and phase taper to maintain a high transmit efficiency. Is that easier to accomplish using multiple modular panels?
- What challenges would thermal control pose to modularity?

4.2.4 Rectenna Design

There is not much evidence of research on large rectenna arrays in the literature. The efficiency of a rectenna seems to be tied to the power density at which it is driven. Since the “near-field” operation makes use of an amplitude and phase taper, it seems like rectenna elements in different portions of the huge array will see different power densities. This is just one issue that makes the huge rectenna an area that needs to be addressed. The development of a huge rectenna that can receive a tapered beam while providing a retrodirective signal is a technology gap that should be addressed.

In the discussion on wireless power transmission, 2.45 GHz was studied because of its location in the ISM band, among other advantages. However, much of the work done on rectenna elements and arrays focuses on a higher ISM-band frequency, 5.8 GHz. The main advantage of the higher frequency is that it requires smaller aperture sizes [83]. A 1000-element rectenna array is proposed in Ref. 83 that exhibited a RF-DC efficiency nearing 80%. The key to obtaining a high efficiency for a large rectenna array appears to be driving all elements within the array near their optimum power density. In the case of a uniformly illuminated array, as discussed in Ref. 83, the rectenna element can be optimized for the anticipated power density. However, in the case of a tapered amplitude distribution (i.e., Gaussian), each element within the rectenna will be subjected to a different power density. Each element in the array will see a different power density, and thus a different voltage will be present at the output of each rectenna element. When these element outputs are summed (series or parallel), the total output has been shown to be lower than anticipated due to a reduced conversion efficiency [79]. Minimizing this problem adds another degree of complexity to the design of such a large rectenna structure.

Various element types have been used in the design of rectennas and rectenna arrays. Circularly polarized (CP) elements are often ideal to eliminate the need to maintain alignment between the transmit and receive polarizations. For CP designs, a truncated microstrip patch element is commonly used [80,84]. The spacing of the array is optimized to reduce the overall number of elements without introducing void areas where the energy will not be collected [84]. To accomplish this, the elements are spaced as widely apart as possible while still maintaining regions where their effective areas overlap. The potentially large spacing is not a problem for grating lobes since only minimal scanning angles are required for maintaining main beam alignment with the transmitting antenna.

4.2.5 Rectenna Power Management and Distribution (PMAD)

The power distribution from the huge rectenna system will be a challenge as well.

The rectenna produces a DC output power that has to be converted to AC to go into the grid. Terrestrial solar arrays already have to handle this problem, so it is likely that the capability exists to handle this interface.

If power is directed into storage, it might be better to not invert the DC power to AC and simply operate at the DC bus voltage for charging. The storage would need to handle the average and peak energy caused by solar events. The storage would also need to be able to provide the power missing when the solar arrays are in eclipse. There would be considerable challenges in implementing such a storage system.

4.3 Satellite Propulsion

Any of the SBSP operational concepts set forward in the NSSO Assessment will require advanced propulsion supporting the launch vehicle, upper stage, and on-board satellite systems in order to provide significant space based power generation and transmission capability. The NSSO Assessment has several findings suggesting the need for improved access to space in the form of low cost, heavy lift, and reusable launch vehicles. This author suggests that much can be accomplished at the demonstration level and early operational levels with the existing fleet of Atlas and Delta EELVs and the emerging NASA Constellation Program Ares I and V Rockets. These vehicles could be coupled with the Orion crew capsule if necessary

for manned on-orbit assembly with an initial capability in approximately 2020. The Ares V has a planned 188 metric ton payload capability to LEO and 71 ton capability to lunar orbit [100] which directly supports a 5 MW class SBSP mission as shown in Table 7. For direct GEO insertion by the launch vehicle, on-board propulsion provides only North-South and East-West station keeping for a 10 year life. For comparison, Table 8 shows a LEO orbit insertion case using the same payload mass, but includes the required propulsion and infrastructure to provide a ΔV 6,000 m/s for the orbit transfer from LEO to GEO and station keeping. As can be seen in Table 9, the Atlas 552 can put 20 metric tons in LEO or 4 tons directly in GEO, and is currently operational [101]. A heavy lift vehicle (HLV) is under development that can improve this capability by an additional 50%.

Table 7 – Allocations 5-MW SBSP System, Direct GEO Insertion by Launch Vehicle

Allocation	Total Mass (kg)	Comments/Basis
Attitude Control	50	Based on Upper Stage
Command & Data Handling	50	Based on Upper Stage
Communications	100	Based on Upper Stage
Mechanisms	500	
Energy Collection	20,000	250 W/Kg
Transmission Payload	10,000	Estimate
Power Distribution & Wire Harness	704	Al Wire 1.4 kg/100m ² for 36000 m ²
Thermal	300	3 large pump loop systems
Misc. Mass/ Margin	100	Estimate
Total Minus Propulsion and Structure	31804	Total of Non-Scaleable Subsystems
Propellant	1150.0	10 Yrs NS-EW GEO Station Keeping, 470 m/s
Propulsion	300.0	Propulsion Dry Mass
Structure	1663	Assume 5% structure
Total Space Vehicle	34917	

Table 8 – Mass Allocations, 5-MW SBSP System, LEO to GEO Transfer

Allocation	Total Mass (kg)	Comments/Basis
Attitude Control	50	Based on Upper Stage
Command & Data Handling	50	Based on Upper Stage
Communications	100	Based on Upper Stage
Mechanisms	500	
Energy Collection	20,000	250 W/Kg
Transmission Payload	10,000	TBD
Power Distribution & Wire Harness	704	AI Wire 1.4 kg/100m ² for 36000 m ²
Thermal	300	3 large pump loop systems
Misc. Mass/ Margin	100	Estimate
Total Minus Propulsion and Structure	31804	Total of Non-Scaleable Subsystems
Propellant	20,000	LEO to GEO Transfer Plus 10 Yrs NS-EW GEO Station Keeping, 6000 m/s
Propulsion	2,200	Propulsion Dry Mass
Structure	5,400	Assume 10% structure
Total Space Vehicle	59404	

Table 9 – Atlas V 400/500 Series and HLV Performance Capabilities Summary

Orbit Type (DV to GSO)	400 Series				500 Series						HLV
	Number of Solid Rocket Boosters										
	0	1	2	3	0	1	2	3	4	5	N/A
	Payload Systems Weight (PSW), kg (lb)										
GTO (1804 m/s)	4,950 (10,913)	6,075 (13,393)	7,000 (15,432)	7,800 (17,196)	3,970 (8,752)	5,370 (11,839)	6,485 (14,297)	7,425 (16,389)	8,240 (18,166)	8,700 (19,180)	13,000 (28,860)
GTO (1500 m/s)	3,765 (8,300)	4,535 (9,998)	5,255 (11,585)	5,885 (12,974)	3,000 (6,614)	4,040 (8,907)	4,930 (10,869)	5,645 (12,445)	6,280 (13,845)	6,695 (14,760)	--
GSO	--	--	--	--	--	--	2,760 (6,085)	3,255 (7,178)	3,730 (8,223)	3,960 (8,730)	6,454 (14,229)
LEO I=28.5 deg	12,500* (27,558)*	--	--	--	10,300 (22,707)	12,590 (27,758)	15,080 (33,245)	17,250 (38,029)	18,955 (41,788)	20,520* (45,238)*	29,400* (64,816)*
LEO Sun-sync	7,095 (15,642)	8,783 (19,320)	10,168 * (22,416)	11,547 * (25,458)	6,319 (13,931)	8,310 (18,320)	10,161 (22,401)	11,803 (26,021)	13,049 (28,768)	14,096 (31,076)	--
Atlas V 400 Series:					Atlas V 500 Series and HLV:						
<ul style="list-style-type: none"> GTO and Sun-sync Performance is SEC LEO 28.5 deg Performance is DEC (402 Only) Quoted Performance is with 4-m EPF 					<ul style="list-style-type: none"> GTO, GSO and Sun-sync Performance is SEC 500 Series LEO 28.5 deg Performance is DEC 500 Series Quoted Performance is with 5-m Short PLF HLV LEO Performance is DEC HLV Quoted Performance is with 5-m Long PLF 						
* For 400 series, PSW above 9,072 kg (20,000 lb) may require mission-unique accommodations. For 500 series and HLV, PSW above 19,051 kg (42,000 lb) may require mission-unique accommodations.											
Note:											
<ul style="list-style-type: none"> GTO (1804 m/s): ≥ 185 x 35,786 km (≥ 100 x 19,323 nmi), Inclination = 27.0 deg, Argument of Perigee = 180 deg, CCAFS GTO (1500 m/s): Apogee Height = 35,786 km (19,323 nmi), Argument of Perigee = 180 deg, CCAFS GSO: 35,786 km Circular (19,323 nmi Circular), Inclination = 0 deg, CCAFS LEO 28.5 deg: 185 km (100 nmi) Circular, CCAFS LEO Sun-sync: 200 km (108 nmi) Circular, VAFB 											
• GCS: Guidance Commanded Shutdown, 2.33 sigma for CCAFS, 3-sigma for VAFB											

The selection of a concrete demonstration and operational mission requirements for SBSP will flow down specific requirements to the launch and on-orbit segments of the mission that can be implemented via launch vehicle, upper stage, and on-board propulsion technologies in phased spiral developments to provide pathways between concept demonstration and the ultimate operational systems. There exist numerous opportunities for investment and development activities within DoD, civil, and industrial aerospace sectors in the forms of advanced component and integrated system technologies. The first major decisions with significant impact on propulsion are the size (mass and volume) of the SBSP system, the operating orbit, and method of fabrication. These basic decisions determine the systematic approach to modularity, and result in a concept of operations and the need for propulsion at each module level. The capabilities can be expanded from a demonstration mission, to an early operational capability, to a fully expandable operational system with long-term capability. When these decisions are coupled with overall cost, timeliness, infrastructure, and capability constraints, then a capability-based demonstration roadmap can be developed showing specific SBPS performance benefits based on technology development metrics.

What is immediately clear is that propulsion technologies will require advancement at the component and system level to support the SBSP mission. Of particular interest are lightweight electric propulsion engines with high thrust to power, high input power, and high propellant throughput capability, and subsystems and integrated systems that support these technologies.

4.3.1 Upper Stages

A direct insertion by the launch vehicle into the mission orbit is always the most cost-effective mission planning solution if the rocket has the performance capability required for the mission. For missions with performance shortfalls, the launch vehicle can be augmented with an upper stage to achieve the desired payload performance. NRL has a rich history of developing upper stages that dispense satellites into mission orbits from launch vehicles [102], with examples being the Multiple Satellite Dispenser, Titan Launch Dispenser, and MiTeX Upper Stage [103] as shown in Fig. 33. Chemical propulsion upper stages could be developed from either the EELV or Ares V that could take a demonstrator class SBSP system directly to GEO for initiation of operations within days of launch.

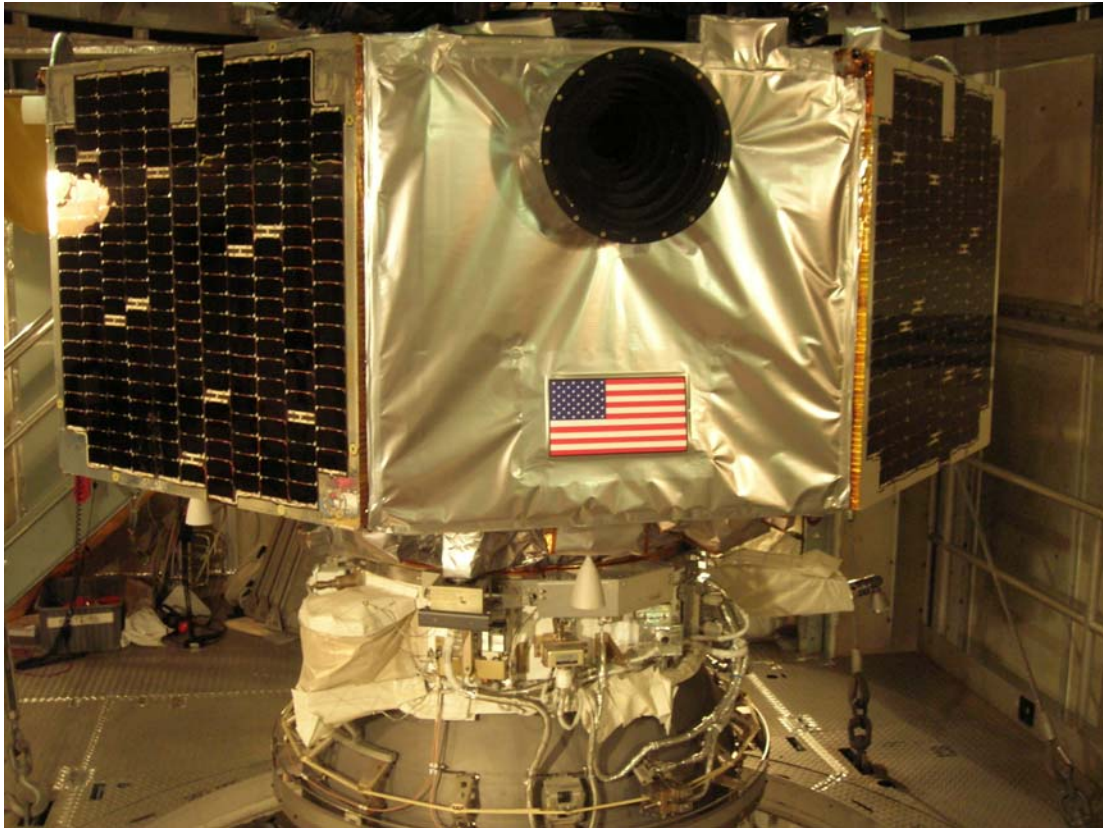

Fig. 33 – MiTex upper stage

The NSSO Assessment findings recommend the need for a Solar Electric Transfer Vehicle (SETV) to deliver large payloads to orbit. NRL has investigated these technologies, and Fig. 34 shows the benefits of such a system for missions with either very high mass or large maneuvering requirements in terms of delta velocity (ΔV). The vertical axis is the percentage of payload delivered to orbit vs the orbital mobility of the system; the higher the payload fraction the better, as it is the payload that performs the mission of interest. The curves show that payload fraction is traded for increased system mobility and the relative performance of different propulsion system types. The difference between the curves is the potential for mass improvement to orbit using an electric propulsion-based thruster system for several mission cases:

- Case 1: LEO-High HEO, LEO-MEO, GEO Station keeping: 15% to 20% Payload Mass Improvement
- Case 2: GTO-GEO: 30% to 35% Payload Mass Improvement
- Case 3: LEO-GEO Missions: 45% to 50% Payload Mass Improvement

Of particular interest is that the payload mass improvement to orbit is not achieved without cost; specifically, there is a significant orbital transfer time associated with electric propulsion.

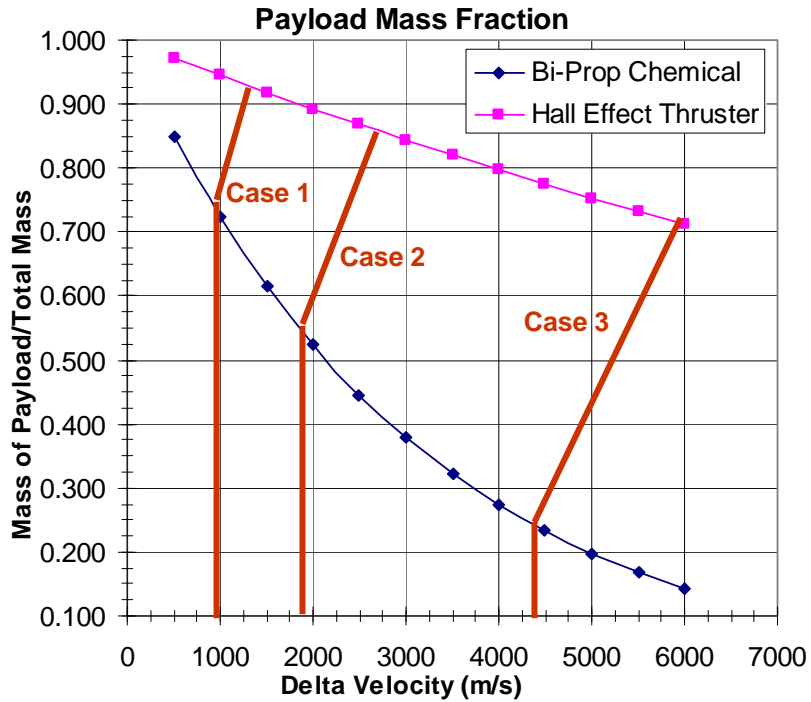

Fig. 34 – Payload mass fraction vs maneuverability

For any Electric Propulsion (EP) based thruster system performing an orbit transfer, the trip time to accomplish the transfer is directly proportional to the power available for the EP thrusters. Some portion of the solar power generation system would need to be deployed and available to support electric propulsion for the orbit transfer from LEO to GEO, but that portion of the power remains to be determined through system optimization. Fig. 35 shows the transfer time based on the power available. It is unclear how much of the total solar power generation capability would be available, or needed, for propulsion due to issues such as partial deployment, off-Sun pointing, and solar eclipse periods. The total transfer time becomes significant for these large payloads if the power available for propulsion is less than 1 MW. For the power available, a minimum number of thrusters is required dependent on the mission redundancy requirements and the maximum power handling capability and throughput of the individual thrusters. As for any system, the minimum number of individual components is desired in order to minimize overall cost, mass, and complexity.

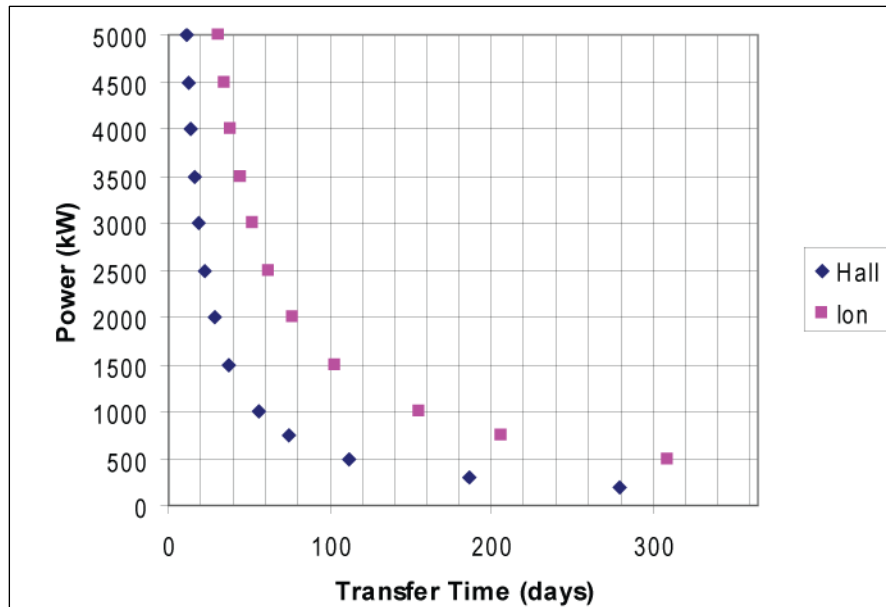

Fig. 35 – Power vs LEO to GEO transfer time

Thrusters capable of handling input power greater than 10 kW have been demonstrated at the prototype level, but would require extensive development to achieve flight status. Near-term capability in the U.S. are arcjet, ion, or plasma thrusters capable of handling up to approximately 50 kW. This is an order of magnitude, and perhaps two, lower than what would be optimal for the orbit transfer between LEO and GEO to minimize the system complexity and resulting payload delivered to orbit. Experimental work with thrusters exceeding 100 kW has been investigated, but never advanced to flight-weight laboratory prototypes. Potential candidate technologies for this type of thruster would be steady state magneto plasma dynamic (MPD) thrusters such as Variable Specific Impulse Magnetoplasma Rocket (VASIMR) [104]. At power levels of the order of 1 MW, MPD thrusters potentially have high enough discharge currents such that self-induced magnetic fields can replace the superconducting magnets required for efficient acceleration.

Photon emission propulsion concepts need to be considered for SBSP for both the potential disturbance effects from the transmission payload and for propulsion for orbit raising or station keeping. The thrust levels due to photon exchange for low power systems are small enough to be negligible for all modern spacecraft, but need to be considered for a high power SBSP payload. The low thrust could not provide orbit transfer with reasonable transfer time, but could require management and control for station keeping purposes. Thrusters of this kind have been conceptualized but not demonstrated operationally [105].

Propulsion technologies supporting an Electric Propulsion Orbital Transfer Vehicle (EPOTV) include advancements in several areas. The engines must be selected and developed for optimal or improved thrust level, efficiency, and specific impulse. Engine operating power and voltage levels (including direct drive technologies) must be determined and these levels need to be throttleable for power and propellant consumption in order to provide maximum utility. Propellants must be evaluated for system performance impact on the thruster, and take into consideration tank storage, pressure management, and flow control requirements. Advancements in any of these areas need to be evaluated on a best value for the SBSP system in terms of payoff/benefit relative to the investment cost.

Traditional EP uses xenon as propellant, but xenon is a trace element in the Earth atmosphere with limited availability and high cost. Alternative propellants would need to be investigated for EP

applications that require metric tons of propellant. Propellant selection is also a thruster performance variable that can be used to tune the performance of the different EP thruster technologies to achieve more optimal thrust, specific impulse, and efficiency. Tests have been performed with alternative gasses such as argon and ammonia, and metals such as bismuth and lithium, but more work would be required in this area.

Once on station, likely at GEO orbit, attitude control and station keeping propulsion will be required to overcome solar pressure and third-body gravitational effects. Traditional non-propulsive attitude control is envisioned for pointing of the satellite, but application of advanced technologies may be beneficial to the system. For station keeping, some portion of the electrical power would be diverted from the solar array to power the thrusters. A potential benefit would be continuous operation of multiple throttleable thrusters that provide both attitude control and station keeping of the system. The thrust from these EP thrusters is anticipated to be less than 1 N which would result in very low acceleration or disturbance of the satellite. At the end of life, satellite removal to a graveyard orbit will be required to assure safety for remaining GEO assets, and use of the EP thruster system is anticipated for this activity as well.

4.3.2 Past Performance

The NCST has performed several studies investigating the required system level technologies supporting an Electric Propulsion Orbital Transfer Vehicle. Such a vehicle acts as an upper stage for a launch vehicle to extend the payload to orbit capability past that achievable by the rocket itself or coupled with a conventional chemical propulsion-based upper stage. This effort identified the following activities that need to be performed to advance the EPOTV system technology:

- Develop a detailed EPOTV performance model allowing NRL to evaluate true expected mission performance
- Identifies a radically new spacecraft system design architecture with viable EPOTV performance
- Develop EPOTV autonomous control methods and algorithms
- Investigate critical enabling technologies
- Identify critical enabling technologies and their relative benefit
- EPOTV technology road map
- Defines the scope and necessary approaches to technology developments
- Performs scale technology demonstrations
- Define EPOTV development road map and the expected performance

NCST performed an LEO to GEO Orbit Transfer Study for the National Reconnaissance Office (NRO) Technology Office that identified an EPOTV using solar electric propulsion as a key enabling technology for delivering large payloads to orbit. The Hall Effect thruster was identified as a key enabling thruster technology and was added to the NRO technology roadmap; it was subsequently demonstrated on orbit in the NRO Space Technology Experiment (STEX) program. This flight in 1998 demonstrated the Electric Propulsion Demonstration Module (EPDM) that the NRL designed and developed to overcome integration and operational issues to successfully perform the first western flight of a gridless Hall Effect thruster. Figure 36 shows the flight system components.

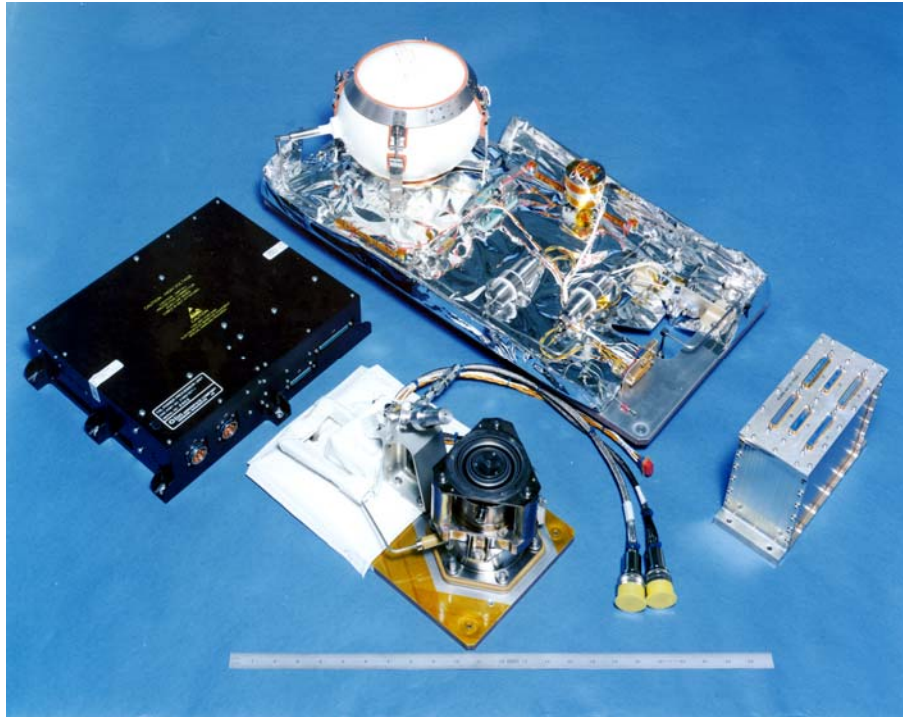

Fig. 36 – Electric Propulsion Demonstration Module flown on the STEX mission

The NRL NCST supports the DARPA Fast Access Spacecraft Testbed (FAST, cf. Section 3.2.2), which is a High Power Generation Subsystem (HPGS) design and demonstration effort with the ultimate goal of achieving 20 kW end-to-end power generation and distribution with specific power of 130 W/kg. The primary focus of this technology is to support rapid payload transport using EP thrusters. Some of the power generation technologies being investigated are applicable for lower power SBSP demonstration systems with power generation requirements under 100 kW.

The DoD-wide technology program is the Integrated High Payoff Rocket Propulsion Technology (IHRPT) program, which advances critical technologies for military applications. IHRPT has developed many thrusters including several high power Hall Engines that can be considered stepping stones to SBSP required power levels.

NRL NCST conducted 6.2 base research in FY05-07 entitled “High Performance Xenon Flow System (XFS) Optimized for Low Mass, Volume, and Cost” [106]. This effort was to design, assemble, and test a prototype of an optimized Xenon Flow System with an order of magnitude reduction in mass and volume over the current state-of-the-art (SOA). The program also collaborated and contributed to a similar NASA In-Space Propulsion activity entitled Advanced Xenon Feed System (AXFS). The results of this effort were the significant advancement of three proportional xenon flow controllers with direct application to throttleable EP thruster systems that would be required for SBSP SETV/EPOTV.

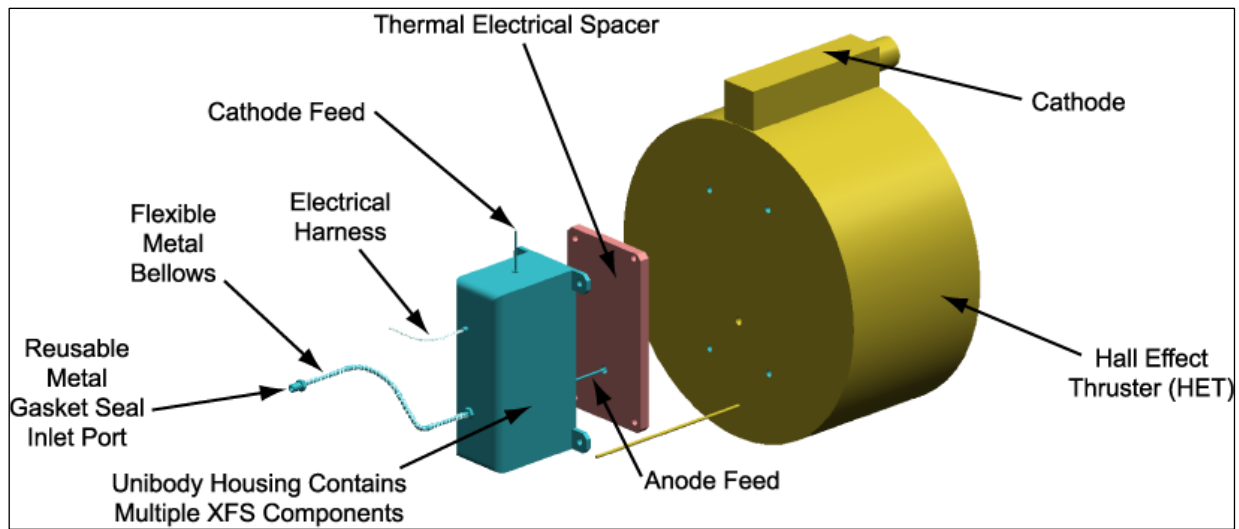

Fig. 37 – NRL 6.2 Research Optimized Xenon Flow System

4.3.3 EP Subsystem Interactions and Issues

High power electric propulsion systems have significant system level interactions and issues that require creative solutions and implementation of advanced technologies. The following paragraphs describe these efforts.

For mission design and planning, the orbital transfer time and trajectories are significant factors that require specialized tools for detailed investigation. These tools have inputs as performance models of the subsystems and environments and compute incremental steps of the orbit transfer. These tools perform optimal trajectory planning required to evaluate steering and throttle profiles for the engine while determining vehicle local acceleration and integrating to get velocity and position. Velocity and position are used for time-based activities such as ground station contacts and radiation dosing of the spacecraft systems based on electron and proton models of the space environment. These conditions are used to predict instantaneous conditions on the vehicle that impact power availability and result in changing EP thruster and vehicle performance. Outputs of these models can be used to determine operational requirements for the components (throttle tables, lifetime, operational cycles, total radiation dose) and to detail the system design. A subset of these algorithms will be used as flight software development tools for an operational system.

Electrical power generation requirements specific to the EP engine and control electronics need special consideration. Current power processing electronics for EP devices are qualified for specific operating power and voltage levels. These levels either need to be accommodated or changed dependent on specific operational characteristics of the solar array and engine systems. If direct drive of the EP engines is selected, solar array strings may require active switching or transformation for continuous voltage optimization of the system.

For the thermal subsystem, heat management systems and techniques must be developed such as advanced heat pipes and heat rejection systems such as advanced radiators for the waste heat from the engines. EP engines have an inherent efficiency that can be improved but is never expected to exceed 70%. This results in 10s of kW of wasted heat at the engine for the smallest suitable engine for SBSP, and could result in up to 1 MW for an optimized high power multi-MW thruster. Such a system would require an elaborate and creative design solution.

For the structures subsystem, the spacecraft subsystems must be packaged with an efficient lightweight design capable of supporting the individual requirements of all the specialized components and systems. Specialized analytical tools and techniques must be developed and utilized to evaluate and assure survival of the loads applied during launch.

For the Guidance, Navigation, and Control subsystem, algorithms and steering laws need to be developed for the autonomous pointing and control for solar arrays, engines, and antennae for optimal system performance. Additionally, autonomous orbit determination and propagation techniques need to be developed for constant thrust operations; this powered flight operational method is significantly different than the short powered flight algorithms used for launch vehicles and the more conventional non-powered flight algorithms currently used for spacecraft. Feedback control systems for each of the systems requiring pointing must be developed. Control system interactions must be evaluated with respect to the other control systems and the extremely large lightweight structures.

For the Command, Telemetry, and Data Handling subsystem, environmental effects such as proton and electron flux, single event upsets, and total radiation dosage must be evaluated, and mitigated with radiation tolerant designs or shielding methods. Power conversion and distribution trades must be performed for the multiple bus voltages taking into account electronic parts capabilities, weight, efficiency, and the power throttling requirements of the engine system.

For the Communications subsystem, the effects of EMI and plume must be evaluated for transmission and self-compatibility effects during thruster operation. EP thrusters with their highly energized plumes are known to be significant sources of emissions. The alternative approach would be to develop low-noise EP thrusters to accommodate the communications subsystems. Techniques must be developed for autonomous antenna transition and switching for signal acquisition when over a ground station.

For the Mechanism subsystem, advanced concepts and hardware need development to address extremely large area deployments, including solar arrays and radiators. Novel hinge and deployment approaches are required to maximize the use of launch vehicle fairing volume. Multi-axis lightweight actuators and controls are required for the actively controlled components. Examples include gimbals for the engine and antenna and the solar array and transmission payload drive motors.

4.3.4 Electrodynamic Tethers

LEO orbit maintenance could be approached by using electrodynamic tethers. Because Earth's magnetic field is very weak at great distances from the Earth, it is not a good candidate for transfer or station-keeping applications involving GEO.

4.4 Advanced Thermal Management Architecture

One of the challenges in many SBSP concepts is to manage the huge amount of waste heat generated during solar power collection, any required power conversion, and wireless power transmission. With the use of solar concentrator and compact electronic packaging in some SBSP concepts, the heat intensity put on the solar cells and transmission electronics is further increased. Traditional thermal management techniques no longer meet the requirements of most SBSP concepts studied. Advanced thermal management technologies are needed to

- transport large amount of waste heat to radiators that point to a favorable thermal environment
- effectively distribute heat over large radiator areas
- manage high heat density in solar cells and conversion and transmission electronics.

Two-phase heat transport systems are identified as a viable technology for SBSP missions. At the spacecraft system level, a two-phase system can be used to transfer heat from a heat source (such as solar collectors and power transmission devices) to a remote radiator, where its location and pointing orientation can be optimized for heat rejection [107-112]. A two-phase system can also provide localized

cooling in a situation where heat density is extremely high. In one concept study, the solar energy is concentrated on the cells with a ratio of 240:1. The solar cell will not survive the heat intensity solely by rejecting heat via its back surface. Alternatively, a two-phase system can be used to absorb heat from the solar cell, distribute it over a larger area, and then reject it to the space.

NRL has contributed significantly in two-phase heat transfer R&D for the past 20+ years [113-120]. We have a state-of-the-art facility to perform tests and qualify flight hardware. Our in-house experts have years of experience and the analytical capabilities to develop two-phase heat transport systems for space missions that have unique and difficult requirements. Our team could provide distinctive benefits for an SBSP program.

4.4.1 Two-Phase Heat Transport Systems

A two-phase heat transport system is a closed-loop system. It contains a two-phase working fluid as the heat transfer media. The working fluid can be either circulated passively by capillary devices such as loop heat pipes, or actively driven by a mechanical pump. The passive devices do not require any external power to drive the system. This simplifies the interfaces with other subsystems. However, the mechanical pump can provide heat transport capability an order of magnitude higher than the passive devices. Figure 38 is a schematic and photograph of a loop heat pipe system. The evaporator contains an internal wick structure, which generates capillary pressure when it is wetted. The working fluid in the evaporator collects heat and vaporizes. Vapor generated in the evaporator travels through a flexible vapor line to the radiator, where it condenses into liquid and rejects the waste heat to space. After condensation, the cold liquid returns to the evaporator through another flexible liquid line.

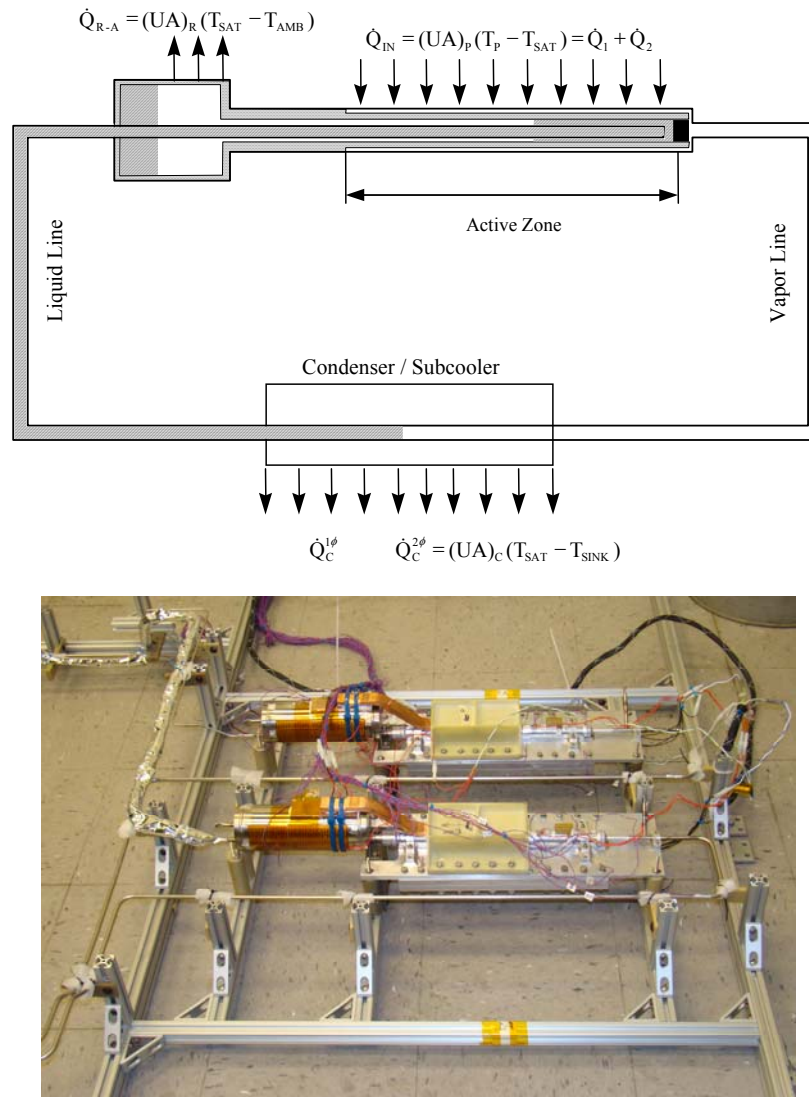

Fig. 38 – Loop Heat Pipe (LHP) schematic and implementation

4.5 Thermal Analysis

A simplified thermal model has been developed to evaluate the thermal effects on the “sandwich” cells concept, where PV cells, DC-RF convertor, and microwave antenna are combined in a same package as shown in Fig. 39. A 1×1 m module is studied in this analysis. It is assumed that the PV cells have a nearly 100% coverage on the $-Z$ surface of the module. The efficiency of the PV cells is assumed to be $\sim 40\%$. The DC-RF convertors and microwave antennas are distributed evenly on the $+Z$ side of the module. The combined efficiency of the convertor and antennas is assumed to be $\sim 80\%$. Overall, the energy transmitted to the Earth is $\sim 32\%$ of the solar energy projected on the PV cells. Around 68% of the energy should be removed from the module. To enhance heat rejection to space, the $+Z$ surface of the module is covered with a high emissivity coating such as Silver Teflon tape. The module travels around the Earth in a geosynchronous orbit with the $+Z$ side pointing at the Earth. In a geosynchronous orbit, the thermal effects of Earth IR radiation and solar albedo are greatly reduced. Solar energy becomes the

primary contributor to the environmental heat load on the spacecraft. Three orbital Sun angles – 0, 45, and 90 deg – as shown in Fig. 40, are considered in this analysis. Figure 41 shows the orbital averaged temperature of the module as a function of Sun concentration and orbital Sun angle. At a Sun concentration ratio of 1, the module reaches ~ 72 °C. Although it is still within the operating temperature of the PV cells, the DC-RF converter and microwave antennas may not survive in this high temperature environment. One alternative design is to thermally decouple the PV cells from the rest of the electronics. In this configuration, the DC-RF converter and microwave antennas can be maintained at a lower temperature. Figures 42 and 43 show the orbital averaged temperature of the PV cells, DC-RF converters, and microwave antennas as a function of Sun concentration and orbital Sun angle. Temperatures of the +Z side electronics are greatly reduced.

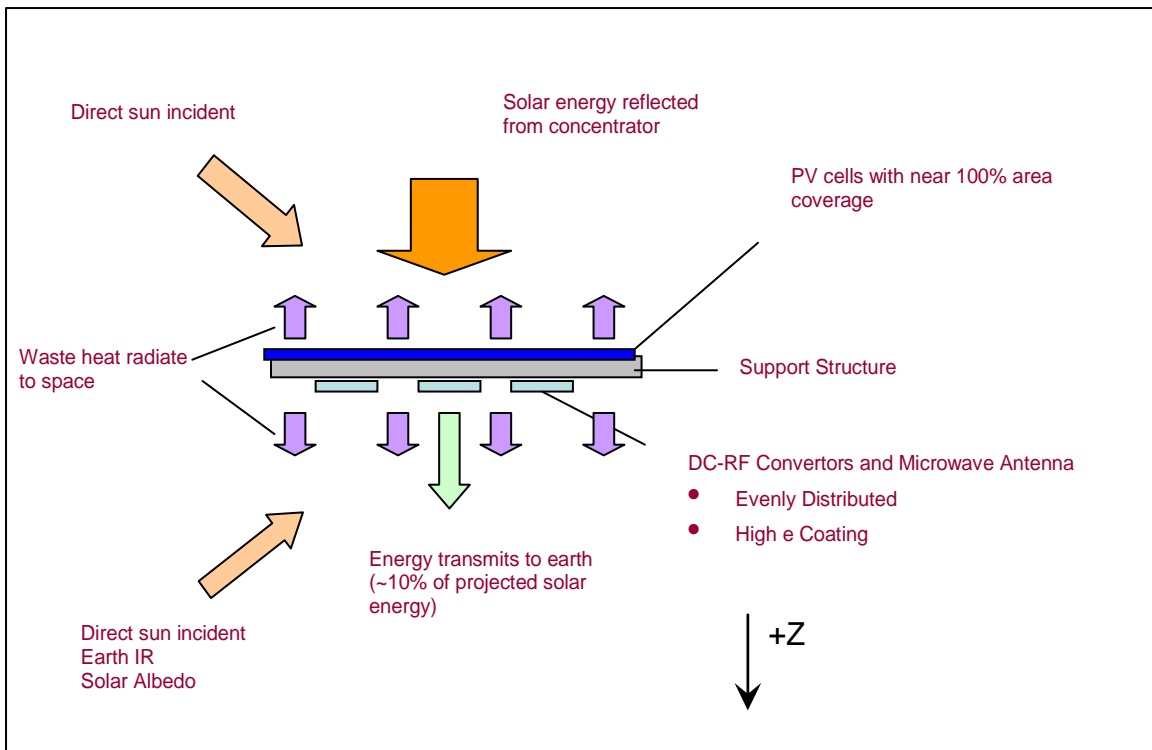

Fig. 39 – “Sandwich” cell concept

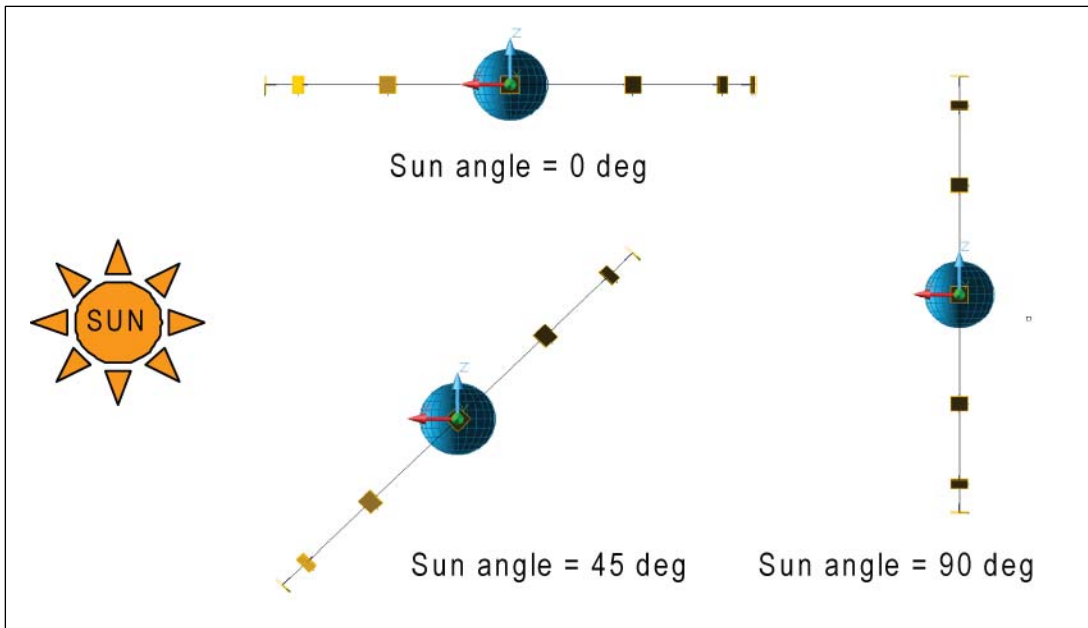

Fig. 40 – Orbital Sun angle definition

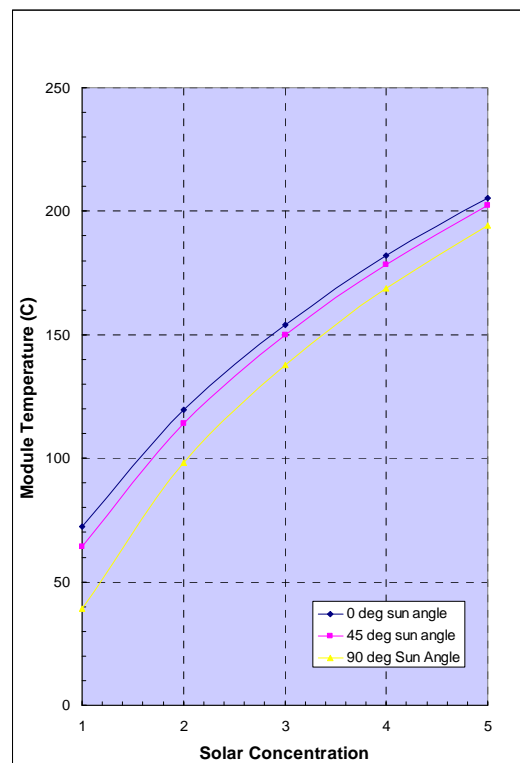

Fig. 41 – “Sandwich” module temperatures

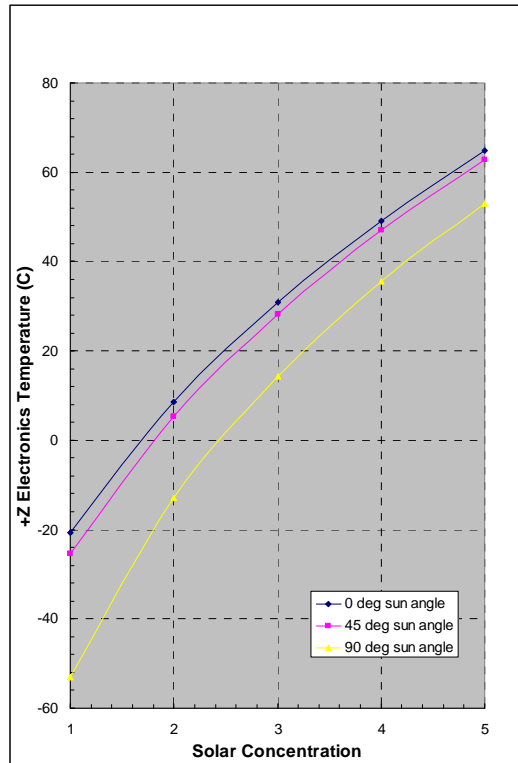

Fig. 42 – +Z electronics temperatures (thermally decoupled from PV cells)

With a Sun concentration ratio of 3, the electronics are able to keep at ~ 40 °C, which is well within their operational temperature limits. However, the PV cells are now operating at much warmer temperatures, as shown in Fig. 42. At Sun concentration ratio of 1, the PV cells are already at 120 °C. Further design optimization can be done to relieve the PV cells temperature by allowing some heat transfer to the +Z side of the module. It is estimated that the module can operate under 1.5 to 2 solar concentration when the heat transfer between the PV cells and +Z side of the module is precisely managed.

It is evident that a two-phase or other heat transport system is necessary in order to operate the “sandwich” cell at a higher Sun concentration ratio. The primary function of a two-phase system is to collect waste heat from the PV cells and the +Z electronics and then transport the heat to remotely located radiators for heat rejection. Shown in Fig. 44 is a “sandwich” structure that is embedded with evaporator channels for actively cooling. Two-phase working fluid is circulated in the closed loop system by pump. Figure 45 shows the amount of radiator area required for a 1 m² “sandwich” module as a function of solar concentration ratio and orbital Sun angle. The corresponding heat load put on the two-phase system is shown in Fig. 46. In this analysis, the PV cells and the +Z electronics are maintained at 100 °C and 40 °C, respectively.

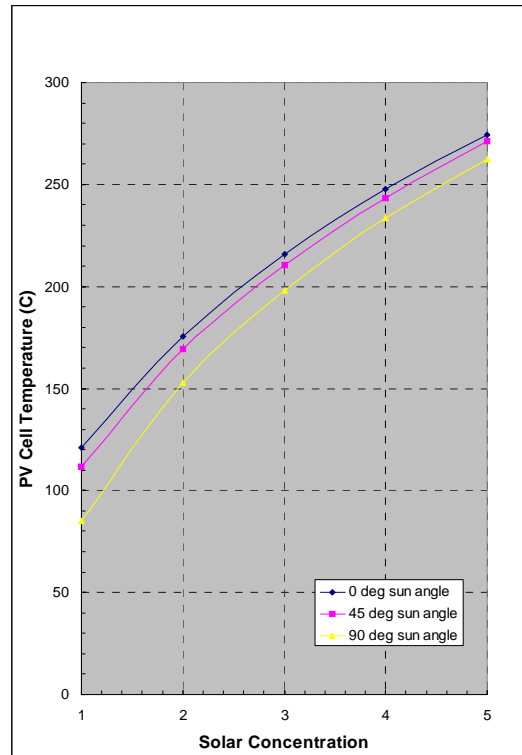

Fig. 43 – PV cell temperature (thermally decoupled from +Z electronics)

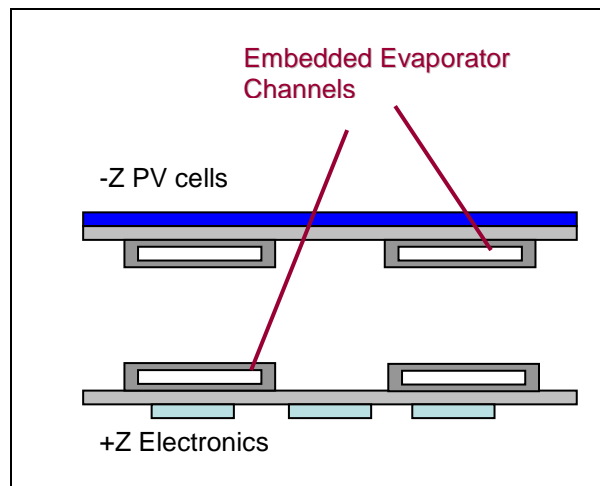

Fig. 44 – “Sandwich module” with embedded evaporators

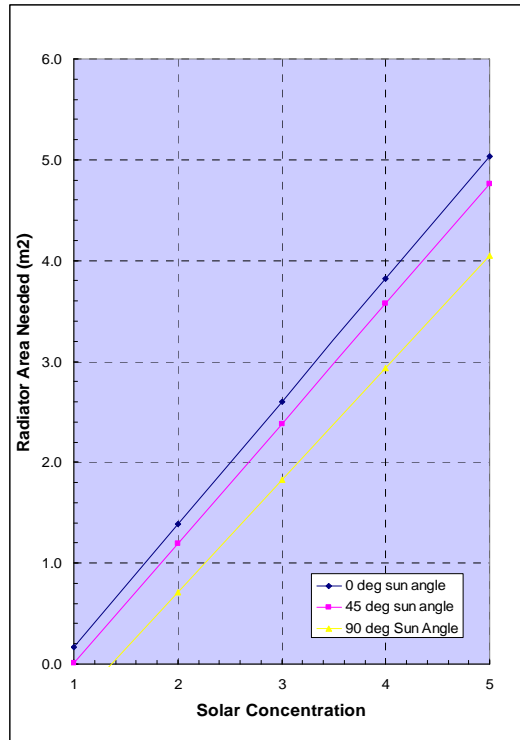

Fig. 45 – Radiator area required for the two-phase system

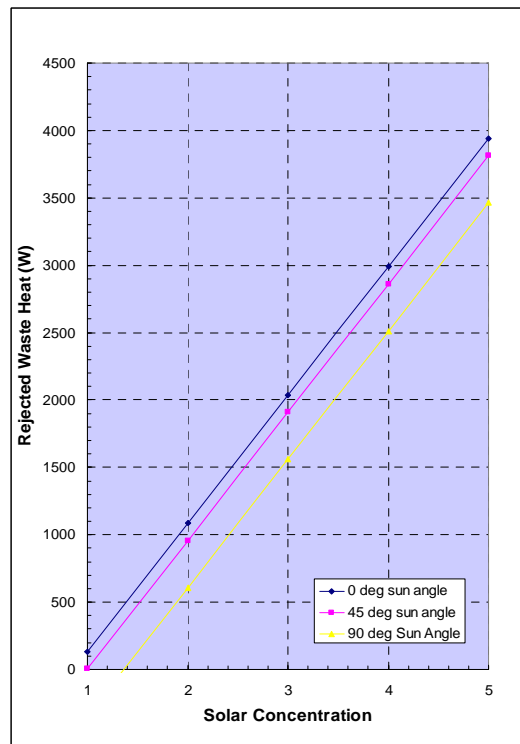

Fig. 46 – Cooling load on the two-phase system

4.6 Space Structure Technologies

4.6.1 Ultralight Structures Descriptions

The SBSP literature shows and describes space structures of multi-kilometer dimensions, but the largest deployable “ultralight” structures commercially available are less than 100 m in length. Furthermore, there are no technologies available for integration of these structures into larger systems.

The principal characteristic of deployable “ultralight” space structures is their continuous axial members (e.g., longerons) as opposed to the use of hinges that add considerable mass. The seminal study defining the efficiency of ultralight graphite composite beams was done in 1978 by Martin Mikulas [121]. However, the problem of stowing the stiff, continuous graphite members was not addressed. The technique for stowage that has been in existence now for several decades is to wind the continuous longerons into a tight spiral inside a canister. This approach couples the beam diameter to the spiral diameter, limiting the elastic modulus of the graphite material, and limiting the beam length as well—state-of-art ultralights are efficient only to lengths of about 70 m. But the very large space structures in SBSP designs require the highest possible stiffness materials to maintain structural shape and increase vibration frequencies to avoid interactions with attitude control.

SBSP systems will require two structural forms: straight beams that can also be integrated into two-dimensional platforms to support higher-mass antennas, and circular or elliptical rims for tensioning thin-film antennas and reflectors.

In a project completed in 2008, NRL has solved this problem with a novel stowage concept (see Fig. 47). The four-longeron truss (or a three-longeron version) called “Superstring” is designed with two longerons on one side slightly closer than the opposite pair. When the beam is compressed by skewing, all longerons lie in the same plane so the beam can be stowed by wrapping around the outside of a drum or the spacecraft itself with no strain between longerons. This decouples truss depth (diameter of longeron circle) from stowage diameter, so that large-diameter stowage allows use of higher modulus graphite materials. External stowage enables construction of beams to multi-kilometer lengths with cross-sections of several meters. Also allowed is stowage and deployment integral with structural monitoring and control devices, power cables, etc., all along the length of the beam. Deployment is done by a single-axis mechanism that pulls the compressed beam off the roll and snaps the nodes together. An interesting feature of this mechanism is that it could, after beam deployment, walk along the beam and if suitably equipped with robotics, integrate the beam into a larger assembly.

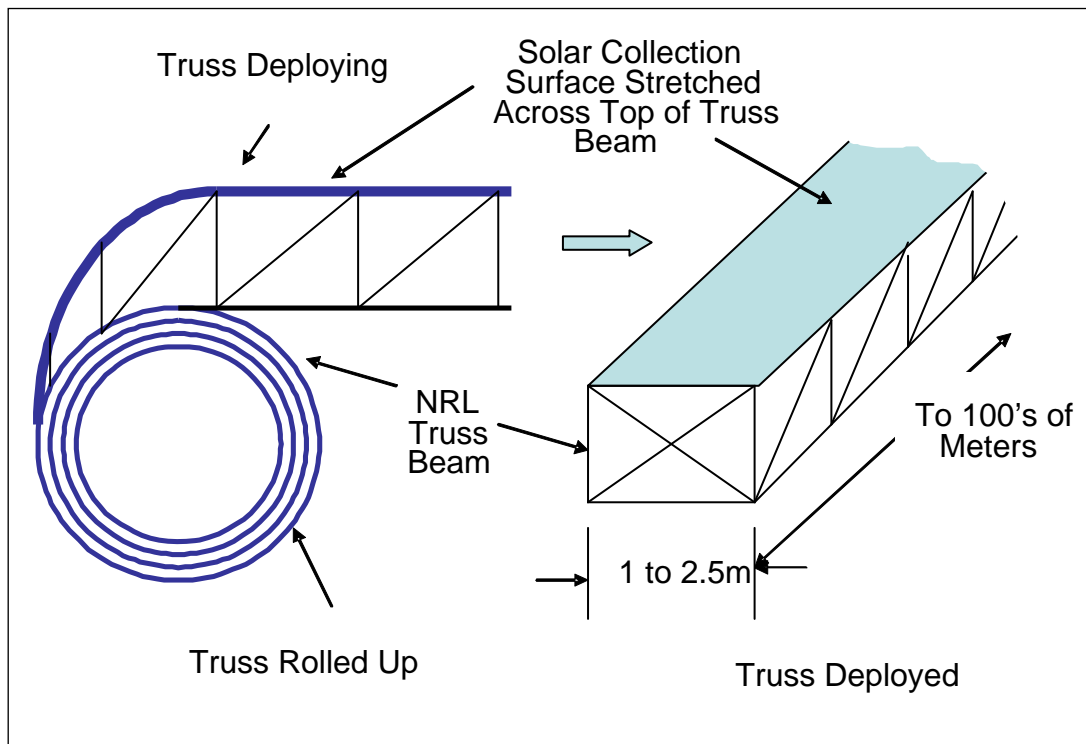

Fig. 47 – NRL deployable ultralight structure concept

A further innovation is a way to replace the solid rod longerons with thin, flat ribbons whose cross-sections curl up after deployment to increase moment of inertia an order of magnitude with no increase in mass per unit length [122]. This allows tighter stowage and use of the highest modulus graphite available. An example of an SBSP application is construction of solar arrays hundreds of meters in diameter. Here an Entech solar concentrator is stretched across one face of the Superstring truss—the truss compresses for stowage to a thickness of about 5 mm, and the solar collector compresses to 0.25 mm, for stowage of over 7 km length in a single roll in a 5-m diameter fairing. A beam width of 2.5 m would be sufficient to assemble the 152-m diameter array described previously. The beams with attached solar collectors are deployed in parallel strips and then structurally cross-linked to provide isotropic bending stiffness.

NRL is also working on the design of a means to stow and deploy antenna rims of kilometer dimensions to support tensioned antennas or reflectors. The structure for this configuration is an isogrid tube. The isogrid is particularly strong in torsion, a necessity for a rim under compressive edge loads. The isogrid tubes would be deployed in straight lengths that would be joined to make a circular or elliptical rim. The thin film antenna material has a catenary edge that is tensioned at the junctions of the rim's tubes. A patented NRL design developed in work with Mantech SRS prevents formation of wrinkles in the antenna material due to edge loads. At each edge load point a device keeps the antenna in proper tension and also maintains planarity.

4.6.1.1 Recommended Research

The next phase in the development of NRL's Superstring beam is development of a "beam walker" deployment mechanism and rolled-up beam deployment to complete mechanical model demonstration.

4.6.1.2 Possible Research Funding

Mantech SRS of Huntsville, Alabama, intends to develop the deployable beam as a marketable product.

4.6.2 Structural Sensing and Control

Because of the unprecedented size of the SBSP structure, it is expected that there will be a need for structural sensing and structural/phase control to correct residual deployment errors, thermal deformations and vibrations. Technologies for shape sensing have been developed and evaluated at NRL [123]. In particular, multiplexed fiber Bragg grating strain sensors [124] have been used to estimate the shapes of various types of structures under operation. Bragg grating sensors having a significant number of sensors on a single fiber and such fibers may also be embedded in the structure. Methods have also been developed for optimal sensor placements and synergy with other sensors [125]. Significant NRL activity has occurred in metrology using lasers, scanning lidars, modulating retroreflectors, and active stereo photogrammetry. These technologies and others would form a repository of methods that would be applied for shape sensing on the SBSP.

Given the extremely low natural frequencies expected for the SBSP structure as well as expected low inherent structural damping there is a high possibility that some form of active structural control would be required to maintain performance. Structural control has been investigated at NRL using actuators that are integrated with truss-like structures known as active struts. These were used to provide active damping to rapidly damp out transients. The control methodologies employed are easily extended to tendon control in which the actuators interact with the structure through tensioned cables. A combination of these methods would form a baseline for structural control of SBSP structures.

The possibility of damage to an extended structure will probably necessitate the incorporation of structural health monitoring which may be combined with robotic inspection and perhaps tele-operated robotic repair. Several techniques for structural health monitoring have been developed and demonstrated at NRL [126]. Some of these approaches were primarily to detect changes in the structures and others were used to diagnose the location of damage. Sensors and actuators already located on the structure for shape sensing and structural control can be used to accomplish this task.

4.7 Space Robotics Technologies

It is generally accepted that the kilometer-class structures required for SBSP would require on-orbit assembly. Autonomous/Tele-operated Robotic assembly is a key technology that significantly reduces or eliminates expensive astronaut extra-vehicular assembly tasks, and is a necessity for operations beyond LEO altitudes. Robotic Assembly on structures of this scale and flexibility has never been attempted and this necessitates careful consideration of robot-structure grappling interactions to avoid large amplitude structural vibrations [127] as well as damage to delicate structural components.

NRL has demonstrated reliable autonomous rendezvous and grapple of free-floating space objects, [128] which requires space-traceable robot arms, algorithms, sensors, and processors capable of implementing machine vision, relative pose estimation, trajectory planning, planning/scheduling, robot-structure contact dynamics, and fault detection through the DARPA-funded SUMO/FREND program (Figs. 48 and 49). In addition to these technologies, NCST has identified further research areas needed to enable orbital robotic construction of large structures. These include multi-arm cooperation, coupled spacecraft/arm control, and advanced proximity and tactile sensing. NCST has ongoing 6.2 research activities in all of these areas. Furthermore, NRL has unique world-class research facilities, including the Proximity Operations Test bed, which enables prototyping, development, and demonstration of individual technologies and systems concepts for orbital construction missions.

Maintaining kilometer-class structures also requires robotic maintenance. Large, complex structures are likely to experience damage from orbital debris as well as lifetime degradation. Robotically servicing

a large space structure requires all of the technologies mentioned above and, additionally, autonomous inspection vehicles, improved end effector mechanisms, tele-operation in the presence of time delay, and the ability to dexterously manipulate damaged parts. NCST has ongoing research activities in autonomous inspection, dexterous manipulation, and tele-operation in the presence of time delay, and has significant in-house expertise in the design of advanced end effectors.

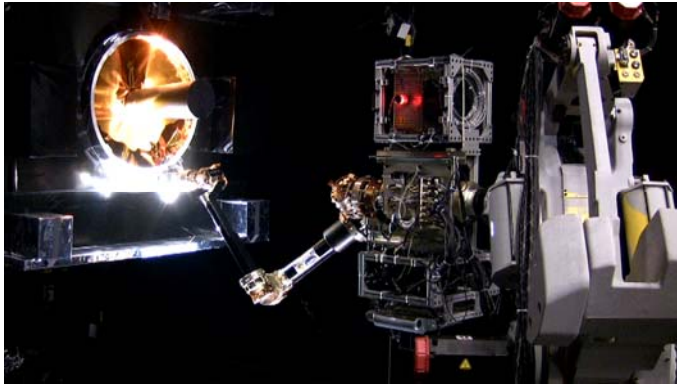

Fig. 48 – SUMO/FREND proximity operations test bed demonstration

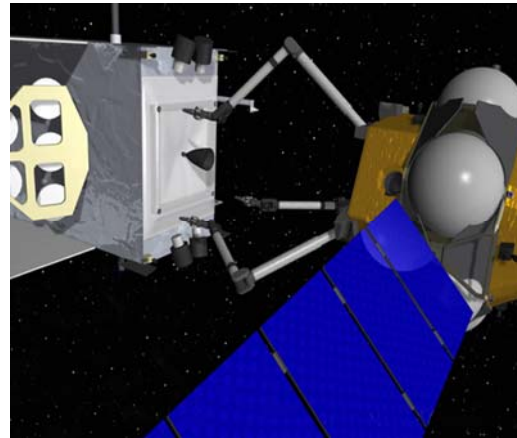

Fig. 49 – SUMO/FREND concept

Other aspects of the SUMO/FREND project that are pertinent include design of robotic end effectors, energy dissipation (through the robot) following grappling, vision algorithms, relative pose estimation and high level robot trajectory planning. NRL work in large truss deployment has produced dual-purpose mechanisms that are able to deploy trusses as well as serve as beam-walkers to convey assembly robots. Relevant NRL 6.2 research projects are ongoing in cooperative robotics, and robotic smart skin technology.

4.8 Structural Analysis of Transmit Array, Solar Collection, and Concentration Structures

Not only do the size and complexity of a space-based solar power architecture rival ground-based civilian structures but the packaging, deployment, and assembly of the space structure impose constraints on the mass, shape, and stiffness of the structure. Moreover, the size of the structure likely precludes any on-ground testing for validation and verification of mathematical models of the structure. A proposed architecture for a 1-km diameter microwave antenna consists of a truss structure supporting thousands of active subarrays. Retrodirective beam control for managing RF energy transmission requires tight tolerances on the flatness of the individual subarrays, which are meters in size, and centimeter tolerances on the shape of the extremely large support structures, which are hundreds of meters in size.

Maintenance of the dimensional tolerance at the locations of the thousands of subarrays that constitute the active elements of the transmit array precludes the use of active control. Instead passive methods are advocated for the restraint of undesirable deformations due to environmental loading such as atmospheric drag, gravity gradients, solar wind pressure, inertial loads attributed to on-orbit maneuvers, assembly configuration changes, and thermal distortions due to moving in and out of eclipse. These passive methods can be obtained through a detailed knowledge of the space environment, accurate mathematical models of the support structure, and manufacturing control of the dimensional tolerances of the subarrays. Thermal distortions can be mitigated through the use of zero coefficient of thermal

expansion (CTE) composite materials. By controlling the layout, composite materials can also be used to tailor structural response to the imposed loads.

The size of the transmit array precludes ground testing of the full scale assembled hardware. However, individual components can be built and tested on ground to verify, validate and update substructure mathematical models. The division of large structures into smaller substructures is a well established methodology in finite element for linear analysis. The internal degrees of freedom of substructure are reduced to a smaller set at the boundaries of the substructure. For a large space structure with repetitive components such an approach is both natural and economical. A natural choice of subdividing the larger structure is in those degrees of freedom controlling the displacement and orientation of the individual subarrays.

4.9 Attitude Control

Attitude control will be a challenging task given the large inertia of the SBSP spacecraft. Disturbances at GEO will be due to solar radiation and gravity gradient. Gravity gradients which are not usually a major consideration at GEO may be important due to the very large inertias, and the spacecraft design may be used to address this by minimizing the differences in principal inertia. It appears that control will most efficiently be done with thrusters (possibly electrical, as described in a previous section) since these are able to take advantage of the significant moment arms afforded by the large dimensions of the SBSP structure. These may also be augmented with Control Moment Gyros. Since the solar pressure will be significant, attitude control methods such as in-plane moving masses and control vanes may also be employed. Another significant issue for attitude control is the changing configuration of the spacecraft during on-orbit assembly and the fact that assembly may have to be done at LEO followed by transfer to GEO. These major changes in the configuration of the spacecraft as well as the disturbance environment may lead to different approaches for the assembly and operational phases.

4.10 Orbital Dynamics: Atmospheric Drag

Aerodynamic drag is an important factor for SBSP notably because it is anticipated that some or all of the assembly of the structure would occur at LEO and the structures in question have large areas and in some cases poor drag coefficients. The primary effect of the aerodynamic drag is in decaying the orbit and potentially de-orbiting the satellite [129]. Disturbance torques are also created that influence the attitude. With proper design, the orbit changing effects are adequately mitigated by firing thrusters and the issue then becomes how to minimize propellant consumption. This simple question admits a wide range of answers and closely couples with decisions on the steps involved in the assembly process as well as their duration. It can easily be seen that it is possible to develop an assembly sequence that is favorable from aerodynamic drag considerations but that such a sequence may incur other costs. The necessary trades would involve choice of assembly/staging orbit, which affects the aerodynamic density and the level/type of LEO vs. GEO assembly. This latter factor comes into play since some components generate significantly more drag than others. Another important issue dictated by aerodynamic drag is the time available at LEO to diagnose propulsion failures before recovery becomes impossible. Worst-case scenarios involving unfavorable solar activity would have to be considered in such cases. Ultimately, aerodynamic drag is a significant variable in determining the sequence of operations necessary to do partial assembly or staging at LEO for GEO concepts. It is even more significant for concepts that operate at LEO and its minimization becomes paramount in the design of such concepts to minimize operational costs.

4.11 Distributed Energy Collection and Management for Space Elements

One issue in energy management is the mass of copper wiring required throughout the entire SBSP system. As an example, the mass of metal wiring was determined for a section of a photovoltaic array one meter wide by 100 meters long (array dimensions that would be typical of large SBSP systems). PV efficiency is 30% and wire maximum temperature is 100 °C. The results given in Table 10 show that for

an operating voltage of 100 V (approximately the highest voltage in space today) a mass of 86.5 kg of copper is required for the 100 m² array. (Note that the 5 MW system described previously has a PV array size of over 36,000 m²!) One solution is to operate at a higher voltage. The Entech solar concentrator described earlier is proposed to operate at voltages in excess of 1,000 V, and the calculations show this would reduce the mass of copper from 85.6 kg to 3.85 kg. If successful, the Entech design would be a truly “enabling technology” for SBSP. Another solution would be to use aluminum wiring instead of copper. Aluminum has resistivity 1.59 times greater than copper, but its mass is about ¼ that of copper. The net result is 63% reduction in wiring mass at any voltage by switching to aluminum. In considering the construction of a SBSP system, the cost of a project to demonstrate aluminum wiring would likely be negligible compared to the cost savings if the project were successful—even with 1 kV. And, if it were successful, it could be applied to other spacecraft.

Table 10 – Electrical Cable Mass vs Design Voltage

Mass of Electrical Cable in Solar Array 1 m × 100 m				
Voltage	Copper		Aluminum	
	kg Mass	% Loss	kg Mass	% Loss
100	85.6	10.3	30.4	11.9
1000	3.85	2.2	1.41	2.51

4.12 Other Areas of Research

Some additional areas of research include:

- Mission and operations modeling for LEO or GEO: Modeling of scenarios for providing power to downlink sites with a demonstrator, constellation, or operational system.
- Modularity studies: antennas, collectors, concentrators, and other SBSP components are subject to trade studies on a wide variety of factors, including launch size and mass, thermal capabilities, suitability for the space environment, and others.

5. DEMONSTRATION CONCEPTS

A number of SBSP demonstration concepts are summarized in Table 11 at the end of this section and are described in the following paragraphs.

5.1 Microwave Power Beaming from the International Space Station

While the actual amount of power received would likely be low, it would be an opportunity to demonstrate and work out some of the intricacies of retrodirective beam control. A group at NASA Glenn is working on this and presented a concept to NASA headquarters in September 2008. Work to move forward with this demonstration was progressing at the time of this writing.

5.2 Earth to LEO Wireless Power Beaming

This technique could be used to provide power to very low orbiting satellites. It could be used in a demonstration fashion for developing beam control techniques, which could then be exploited for a LEO to Earth link or extended to GEO. Transmitting from Earth eases transmit implementation testing and iteration. This demonstration also benefits from the asymmetry of atmospheric effects, as it is easier to “look up.” Very powerful transmission facilities, such as the DSN Goldstone Solar System Radar, already exist and might be employed in such an endeavor.

5.3 An International Collaboration LEO Free-Flyer Demonstrator Hosting One or More SBSP Technology Demonstrations and Experiments

Because of the wide international interest and investment in SBSP, it offers unique possibilities for collaboration. Costs and benefits of a technology demonstration mission would be shared alike, not only building international goodwill, but moving the participant countries’ technology forward. As a leader in space, the U.S. is well positioned to propose, support, and lead such a collaboration. NRL has a history of collaborating with national and international partners on many previous missions, including LACE, SOHO, STEREO, GRO, GLAST, MPTB, among others and could play a vital role.

Power transmission demonstration missions, particularly those in low Earth orbit, lend themselves to providing power to or allowing retrodirective control by multiple ground stations located at various places around the globe as the satellite comes into view of the ground station. This allows full participation by many partners. Figures 50 through 52 show three notional SBSP technology demonstration missions.

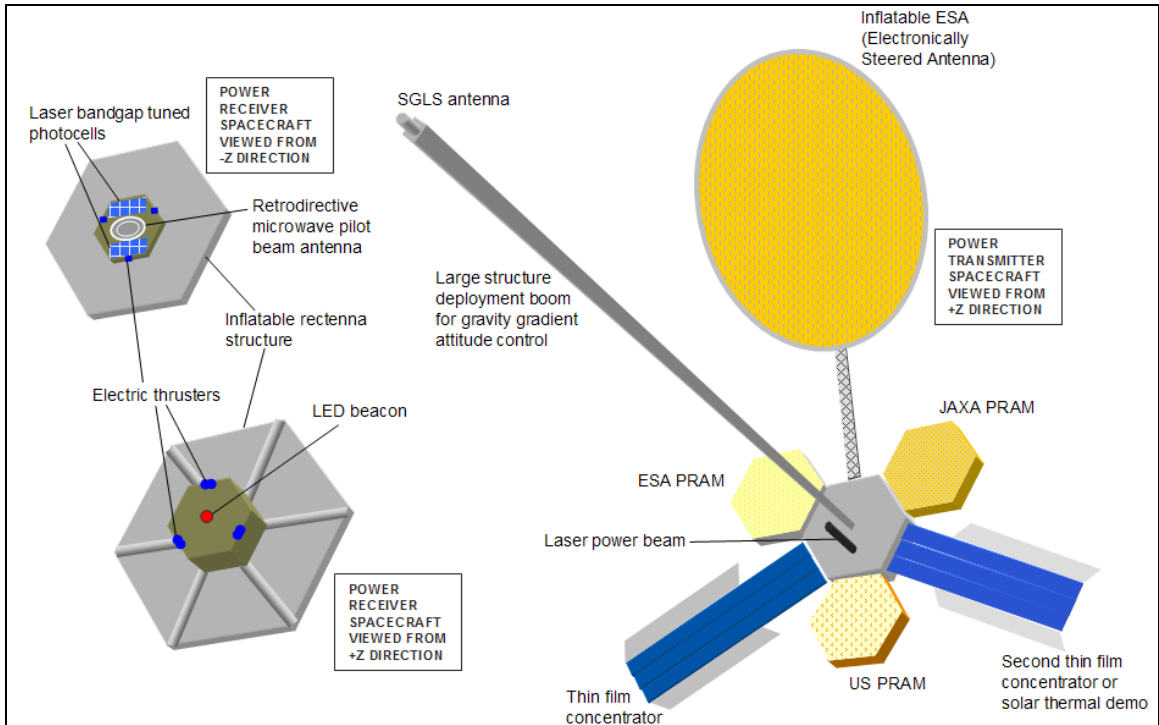

Fig. 50 – A notional international SBSP technology demonstration mission

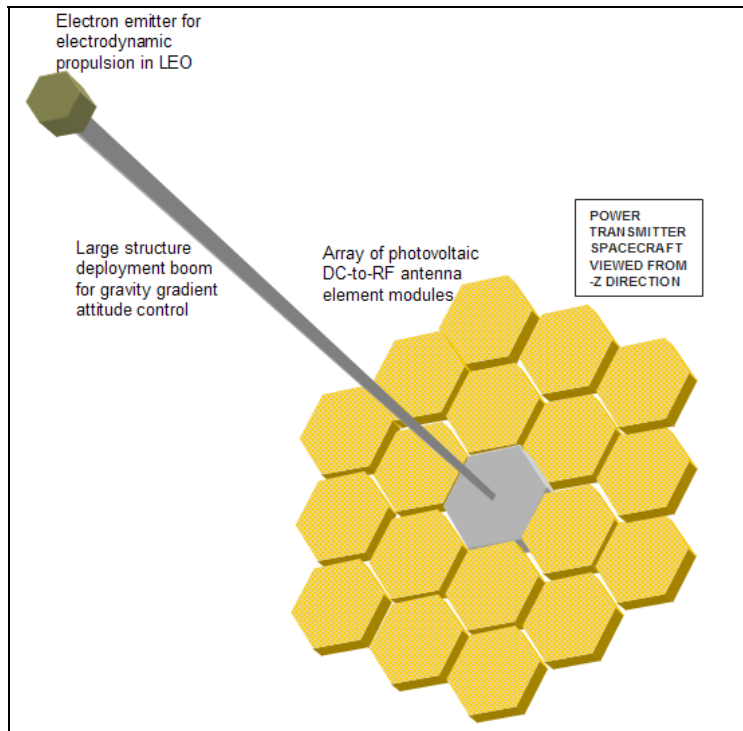

Fig. 51 – A notional large structure and sandwich module demonstration mission

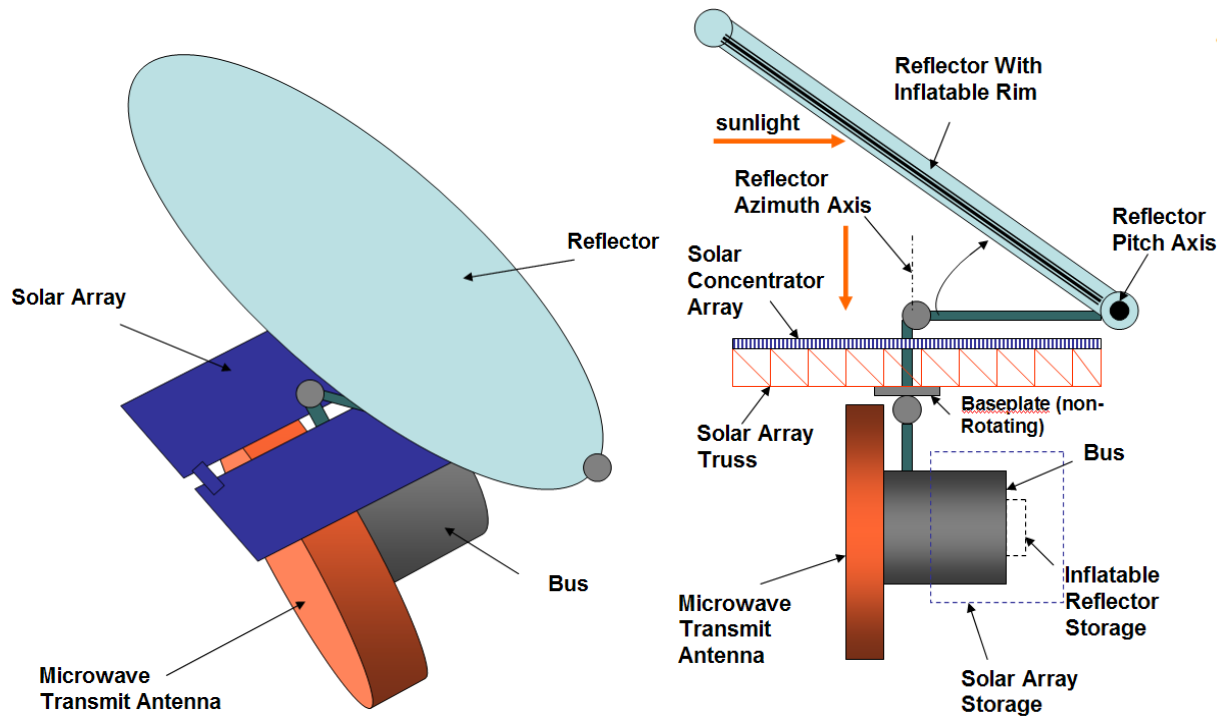

Fig. 52 – A notional perpendicular to orbit plane demonstration mission

5.4 Demonstrations Employing High Altitude Vehicles

Many of SBSP's component technologies can be tested by using lighter-than-air vehicles to reach near-space altitudes of 30 km. This technique was successfully employed in the Spring of 2008 by John Mankins' team in testing Entech lens concentrated solar cells.

5.5 Ground-Based Demonstration of Robotic Assembly of Space Structures

The NSSO report recommends starting with ground demonstrations of robotic deployment and assembly of large structures.

Although there has been some analytical and preliminary experimental work performed [130], there have not been significant robotic assembly demonstrations that involve the types of structures and materials that will be used in SBSP systems. SBPB antenna support structures are projected to have significant flexibility prior to full assembly, which mandates that methods of handling large quasi-static thermal/residual deflections and vibrations during assembly will have to be demonstrated. In addition, lightweight and relatively fragile antenna waveguide materials may need to be handled. A robotic assembly ground demonstration that incorporates the assembly of flexible lightly damped truss structures with lightweight antenna elements should be undertaken to prove this technology. For NRL, this would be a follow-on effort to the Superstring truss beam development as recommended in the 6.2 Work Unit 6569: "Compact Deployable Micro-Sat Structures for Enhanced Detection and Communication." This would include larger cross-sections of 20 m length, and a demonstration of the deployment mechanism acting as a "beam crawler" for integration of the beam with other hardware and for repairs. NRL personnel have been involved in robotic grappling and flexible structures research and are well positioned to carry out such a demonstration. A large space robotics lab facility is available that provides two six-degree-of-

freedom platforms, and these are able to react to forces and moments to simulate a variety of controlled/passive on-orbit motions. This facility has been used to simulate/demonstrate an attitude-stabilized bus carrying a robot that autonomously grapples an uncontrolled (i.e., passive) bus and would provide an ideal environment to perform assembly demonstrations.

5.6 A Very Large Structure Robotic Construction Demonstration in Space

One demonstration would be to create a portion of a large array support structure or passive solar reflector. The technology to validate is the joining and structural cross-linking of parallel lengths of the Superstring beam to make a 2-D “plate,” followed by demonstrations of robotic integration and repair of electrical components to create a working PV array, or any other on-orbit robotic work that may be suggested.

Another possibility is to create a passive reflector of large size. This dramatically simplifies the electrical design and still would demonstrate large structure construction capabilities.

5.7 Laser or Microwave Terrestrial Power Beaming Demonstrations

Such demonstrations might not only lead to development in relevant technologies for SBSP, but for other wireless power beaming applications as well. AFRL and the Air Force Institute of Technology (AFIT) have proposed such demonstrations for upcoming FalconSAT missions at the U.S. Air Force Academy [131].

Table 11 – Summary of Demonstration Concepts

Demonstration Concept	Technology Advanced	Cost range
Ground-based demonstration of robotic assembly of space structures	SS&A	\$2M-\$20M
A large structure robotic construction demo in space	SS&A	\$80M-\$400M
An international collaboration LEO free-flyer demonstrator hosting one or more SBSP technology demonstrations and experiments	PV, WPT, SS&A	\$40M-\$1B
Microwave power beaming from the International Space Station, using its existing solar arrays (currently being pursued by NASA)	WPT	\$40M-\$80M*
Demonstrations employing high altitude vehicles	PV, WPT	\$5M-\$30M
Earth to LEO microwave power beaming	WPT, SS&A	\$80M-\$300M
Laser or microwave terrestrial power beaming demonstrations	WPT	\$1M-\$50M
SSA = Space Structures and Assembly PV = Photovoltaics WPT = Wireless Power Transfer *shuttle or other launch provided		

6. POSSIBLE FUNDING AGENCIES

A number of agencies have funded SBSP research in the past, and with sufficient political will it is likely that these same agencies or new agencies would fund future SBSP work. Such work would likely be applicable to both prospective civil and defense SBSP systems.

6.1 The National Aeronautics and Space Administration (NASA)

NASA has funded significant SBSP studies and research in the 1970s, 1990s, and 2000s. NRL has performed work for NASA under SBSP-related programs, and some of the technologies described in this report were developed in part with such funding.

6.2 The U.S. Department of Energy (DOE)

The DOE together with NASA funded the comprehensive 1970s study of SBSP. With continued increases in energy costs, DOE may again be in a position to fund SBSP studies and research.

6.3 The U.S. Department of Defense (DoD)

If sufficient priority is placed on reducing dependence on foreign energy sources and increasing self-sustainability of military installations, DoD may fund SBSP work. The Air Force, Office of Naval Research, DARPA, National Reconnaissance Office (NRO), and other DoD entities have funded science and technology development pertinent to SBSP.

6.4 International Partners

India, Japan, and European countries have expressed explicit interest in further spurring and extending SBSP technologies and system development. They comprise another possible source of funding, especially if incentivized by like contributions from U.S. sources.

6.5 The U.S. Department of State or United Nations Office for Outer Space Affairs (UNOOSA)

SBSP offers possible political and humanitarian benefits. Though these agencies might not fund SBSP development directly, they might be employed in mustering political will to fund such activities.

6.6 Corporate Partners

Space and energy industry corporations will likely be hesitant to fund the development of system until the concept has been successfully demonstrated and has a solid business case. Component technologies may be funded by corporate internal research if they also have applicability elsewhere.

6.7 A New U.S Government Entity

It has been observed that because SBSP does not constitute an exploration activity, it does not exactly fall under the purview of NASA, and that since it is a space activity, it likewise does not fall under the purview of the DOE. Perhaps political pressure could result in an agency that would be created to deal with SBSP specifically, much as been done in Japan and elsewhere. Alternately, an existing agency like the Department of Commerce's Office of Space Commercialization might be charged with promoting SBSP development.

7. RECOMMENDED NEXT STEPS

Ideally, sponsors would step forward to fund a detailed system design study, focused component technology development, or a technology demonstration mission. NASA, JAXA, and the NSSO report each propose roadmaps and pathways to operational systems that are largely relevant to both utility grid and defense application SBSP systems. Lacking a large goal-driven initiative, much work can continue as it has on a smaller scale, with component technology development with broad applications being funded by a variety of sponsors. A summary of technologies and research in which NRL is well-positioned to contribute is shown in Table 12.

Table 12 – High Priority NRL Contribution Research Areas

Technology Area	NRL Precursors	Recommended research
Space Structures	Superstring longeron truss	Beam walker and rolled-up beam deployment mechanism development and demonstration
Space Robotic Assembly	Satellite for the Universal Modification of Orbits (SUMO), Front-End Robotic Enabling Near-Term Demonstrations (FREND)	Co-operative robotics, smart skin technology, space robotic structure assembly
Space Subsystem Development	W-band transponder, Frangibolt deployment mechanism, atomic clocks for spaceflight, etc.	Photovoltaic RF-conversion antenna module research, a.k.a “sandwich“ module
Thermal Management	Two-phase heat pipes, diamond substrate heat management	SBSP detailed component alternatives thermal analysis, e.g., the “sandwich“ module
Photovoltaics	TacSat-4 solar cell experiment	Photovoltaic collector and concentration experiments
RF amplifier technology	Multiple beam klystrons, coupled-cavity and helix traveling wave tubes	Phase-controllable, lightweight, high-efficiency, multipactor-resistant microwave sources in the 2 to 15 kW range
Propulsion	High Performance Xenon Flow System, Electric Propulsion Demonstration Module (EPDM), Advanced Tether Experiment (ATEX)	Long duration electric propulsion for large structures, LEO to GEO transfer propulsion, station-keeping, LEO electrodynamic tethers
Spacecraft Engineering	Clementine, TacSat-1, TacSat-4, WindSat, Upper Stage, Interim Control Module, etc.	In-orbit robotic construction demonstration, SBSP-related technology free-flyer experiments
Energy Management & Storage	Spacecraft power subsystems, Sodium Sulfur Battery Experiment (NaSBE)	SBSP flight power architecture, Large capacity ground load-leveling storage capabilities

It is possible now to build a low-power LEO system experiment or series of experiments that would not require breakthrough technologies and that could be launched on a single launch vehicle. This would likely speed closure of some of the outstanding technical questions for SBSP and enable iteration toward optimum designs for defense and civilian SBSP systems.

Though more challenging, it is possible even without the knowledge gleaned from flight experiments to create today a detailed design of a MW-sized system that would require us to identify technologies that require development. This would help focus hardware development work in advanced technologies required by large SBSP systems, technologies which are likely to have other useful applications as well.

In summary, our recommendations are:

- Members of the NRL SBSP Study Group, in collaboration with all NRL interested scientists, should:
 - Proceed to maintain meaningful and continuing engagement with the wider SBSP community and its efforts, both nationally and internationally.
 - Pursue sponsors to mount compelling demonstrations related to space-based solar power, with continued attention to military-specific opportunities.
- NRL leadership should consider continuing and expanding funding for energy technologies (generation, transmission, storage, etc) including, as appropriate, funding for SBSP component technologies and experimentation.

The consensus among participants in this study was that the concepts and technologies involved are integral to many national security applications. Profound opportunities exist for furthering the state of the research and especially for collaborating with others engaged in similar research, including those at NASA, JAXA, and other entities. As the first organization to fly solar cells in space, it seems only fitting that NRL should contribute to the development of SBSP.

We agree that the need for energy independence is an important strategic objective for maintaining our national security. SBSP should be examined in detail in addition to other alternatives currently being considered.

REFERENCES

1. Report of the Defense Science Board Task Force on DoD Energy Strategy “More Fight – Less Fuel,” February 2008, Office of the Under Secretary of Defense for Acquisition, Technology, and Logistics, Washington, DC, 20301-3140.
2. N.J. Willis, *Bistatic Radar* (SciTech Publishing, 2005) ISBN 1891121456.
3. http://en.wikipedia.org/wiki/System_F6 accessed 2008-09-17
4. D. Sievenpiper, “High-Efficiency, Large-Aperture Rectennas for Assured Military Access to Space,” Contract N00014-04-C-0171, F6 Workshop, August 2006.
5. “QinetiQ’s Zephyr UAV flies for three and a half days to set unofficial world record for longest duration unmanned flight,” http://www.qinetiq.com/home/newsroom/news_releases_homepage/2008/3rd_quarter/qinetiq_s_zephyr_uav.html accessed 2008-09-17.
6. DARPA Tactical Technology Office Website, “Vulture,” <http://www.darpa.mil/tto/Programs/Vulture.htm>, September 2008.
7. L. Shiner, “Where the Sun Does Shine,” *Air & Space*, June/July 2008, p. 56.
8. Report of the URSI Inter-Commission Working Group on SPS, June 2007, Appendix A.

9. Report of the URSI Inter-Commission Working Group on SPS, June 2007, Appendix D.7.
10. P.E. Glaser, "Power from the Sun: Its Future," *Science* **22**(162), 857-861, November 1968.
11. P.E. Glaser, F.P. Davidson, and K. Csigi (eds.) *Solar Power Satellites* (West Sussex, England, Praxis Publishing Ltd., 1998).
12. Report of the URSI Inter-Commission Working Group on SPS, June 2007, Appendix C.3.1.
13. Report of the URSI Inter-Commission Working Group on SPS, June 2007.
14. J. Penn and G. Law, "Aerospace Systems Analysis and Modeling of Five Candidate Space Solar Power Concepts," 2001.
15. J.P. Penn and G.W. Law, "Operational and Demonstrator Laser Concept Model Development," Final write-up for extension to Contract No. NAS8-99143, June 10, 2002.
16. J.P. Penn and G.W. Law, "The Aerospace Corporation Systems Studies and Analysis of the Space Solar Power (SSP) Exploratory Research and Technologies (SERT) Concepts and Applications," Contract No. F04701-93-C-0094, March 9, 2001.
17. J.C. Mankins, "Energy from Orbit," *Ad Astra* **20**(1), Spring 2008.
18. *Space-Based Solar Power As an Opportunity for Strategic Security*, Phase 0 Architecture Feasibility Study, National Security Space Office, Release 0.1, 10 October 2007.
19. "A Solar Dynamic Power Option for Space Solar Power," NASA TM 1999-209380.
20. D. Hervol and M. Briggs, "Experimental and Analytical Performance of a Dual Brayton Power Conversion System," AIAA 2008-5735.
21. <http://www.johnsonems.com/jhtec.html> - the Johnson Thermo-Electrochemical Converter, and U.S. Patent 7,160,639 - Johnson Reversible Engine.
22. M. O'Neill, J. Howell, J. Fikes, L. Lollar, C. Carrington, N. Suzuki, M. Piszczor, D. Hoppe, M. Eskenazi, D. Aiken, M. Fulton, H. Brandhorst, M. Schuller, and A.J. McDanal, "Stretched Lens Array SquareRigger: A New Space Array for High-Power Missions," 4th World Conference on Photovoltaic Energy Conversion, Waikoloa, Hawaii, May 7-12, 2006.
23. J. Sponable, K. Hwang, and K. Royster, "FAST & HiDVE IHPRT Briefing," Tactical Technology Office, Defense Advanced Research Projects Agency, August 21, 2008.
24. B. Sanii, "Calibrating Surface Weather Observations to Atmospheric Attenuation Measurements," The Interplanetary Network Progress Report, paper 2 in TMO Progress Report 42-145, Jet Propulsion Laboratory, May 15, 2001.
25. A. Biswas and S. Piazzolla "Deep-Space Optical Communications Link Availability and Data Volume," The Interplanetary Network Progress Report, paper 4 in IPN Progress Report 42-162, Jet Propulsion Laboratory, August 15, 2005.
26. MODTRAN 4 Software Fact Sheet, MOD4v3r1, <http://www.kirtland.af.mil/library/factsheets/factsheet.asp?id=7915>, downloaded from Kirtland Air Force Base Website on September 12, 2008.
27. B. Sanii, Jet Propulsion Laboratory, "Atmospheric Attenuation Calibrations of Surface Weather Observations," Photonics West, Free-Space Laser Communication Technologies XII, San Jose, SPIE, January 25, 2001.
28. Report of the USRI Intercommission Working Group on SPS, June 2007.

29. W.C. Brown and E.E. Eves, "Beamed Microwave Power Transmission and its Application to Space," *IEEE Trans. Microwave Theory and Techniques* **40**(6), 1239-1250, 1992.
30. M.A. Green, K. Emery, Y. Hishikawa, and W. Warta, "Solar Cell Efficiency Tables, Prog. Photovolt," *Res. Appl.* **16**, 61, 2008
31. M.A. Stan, D.J. Aiken, A.B. Cornfeld, B. Cho, J. Diaz, A. Korostyshevsky, V. Ley, P. Patel, P. Sharps, and T. Varghese, "Evolution of the High Efficiency Triple Junction Solar Cell for Space Power," 33rd Photovoltaic Specialists Conference, 2008, in press.
32. C. Fetzer, B. Jun, K. Edmondson, S. Khemthong, K. Rouhani, R. Cravens, R. Bardfield, and M. Gillanders, "Production Ready 30% Efficient Triple Junction Space Solar Cells," 33rd Photovoltaic Specialists Conference, 2008, in press.
33. N.S. Fatemi, "Satellite Market Trends and the Enabling Role of Multi-Junction Space Solar Cells," 33rd Photovoltaic Specialists Conference, 2008, in press.
34. A.B. Cornfeld, M.A. Stan, T. Varghese, J. Diaz, A.V. Ley, B. Cho, A. Korostyshevsky, D.J. Aiken, and P.R. Sharps, "Development of Large Area Inverted Metamorphic Multi-junction (IMM) Highly Efficient AM0 Solar Cell," 33rd Photovoltaic Specialists Conference, 2008, in press.
35. Amonix web site
36. P.J. Verlinden, A. Lewandowski, H. Kendall, S. Carter, K. Cheah, I. Varfolomeev, D. Watts, M. Volk, I. Thomas, P. Wakeman, A. Neumann, P. Gizinski, D. Modra, D. Turner, and J.B. Lasich, "Update on Two-Year Performance of 120 KWP Concentrator PV Systems Using Multi-Junction III-V Solar Cells and Parabolic Dish Reflective Optics, Solar Systems Pty Ltd, Hawthorn, Victoria 3122, Australia, 33rd Photovoltaic Specialists Conference, 2008, in press.
37. A.W. Bett, J. Jaus, G. Peharz, G. Siefert, A. Hakenjos, I. Heile, and J. Wüllner, "Outdoor Evaluation of FLATCON Modules and Systems," 33rd Photovoltaic Specialists Conference, 2008, in press.
38. M.J. O'Neill and A.J. McDanal, "Development of Terrestrial Concentrator Modules Using High-Efficiency Multi-Junction Solar Cells," 29th Photovoltaic Specialists Conference, p. 3169, 2002.
39. H.W. Brandhorst Jr., J.A. Rodiek, and M.J. O'Neill, "Stretched Lens Array: the Answer to Improving Solar Array Reliability," 33rd Photovoltaic Specialists Conference, 2008, in press.
40. E. Ferrando, R. Contini, R. Romani, R. Campesato, and M.C. Casale, "Comparison Between CIGS and TJ GaAs on Thin Ge Solar Cell Assemblies and Related Development Strategies," 33rd Photovoltaic Specialists Conference, 2008, in press.
41. K. Shimazaki, M. Imaizumi, T. Ohshima, H. Itoh, and K. Kibe, "Analysis of Radiation Response and Recovery Characteristics of Amorphous Silicon Solar Cell," Conf. Record of 2006 IEEE 4th World Conference on Photovoltaic Energy Conversion, Vol. 2, 2006, p. 1797.
42. A. Jasenek, U. Rau, K. Weinert, H.W. Schock, and J.H. Werner, "Radiation Response of Cu(In,Ga)Se₂ Solar Cells," Proceedings of 3rd World Conference on Photovoltaic Energy Conversion, Vol. 1, 2003, p. 593.
43. Scott Messenger, private communication, August 2008.
44. J.E. Granata, T.D. Sahlstrom, P. Hausgen, S.R. Messenger, R.J. Walters, and J.R. Lorentzen, "Thin-film Photovoltaic Radiation Testing and Modeling for a MEO Orbit," Photovoltaic Specialists Conference, 2005, Conference Record of the Thirty-first IEEE Jan. 3-7, 2005, pp. 607 – 610.
45. H.W. Brandhorst Jr., J.A. Rodiek, and M.J. O'Neill, "Stretched Lens Array: The Answer to Improving Solar Array Reliability," 33rd Photovoltaic Specialists Conference, 2008, in press.

46. See, for example, D.M. Murphy, "The SCARLET Solar Array: Technology Validation and Flight Results," Deep Space 1 Technology Validation Symposium, Pasadena, 2000, and D.M. Murphy, "The SCARLET Solar Array: Technology Validation and Flight Results," Deep Space 1 Technology Validation Symposium, Pasadena, 2000.
47. E.G. Memi, "International Space Station Electric Power System (EPS) Overview," Boeing IDS Business Support, St. Louis, MO, Nov. 21, 2006.
48. N. Shinohara and H. Matsumoto, "Design of Space Solar Power System (SSPS) with Phase and Amplitude Controlled Magnetron," Proc. of 2004 Asia-Pacific Radio Science Conf., IEEE 0-780308404-0/04, pp. 624-626 (2004).
49. S. Kawasaki, "A Unit Plate of a Thin, Multilayered Active Integrated Antenna for a Space Solar Power System," *URSI Radio Science Bulletin* **310**, 15-22, September 2004.
50. URSI white paper on Solar Power Satellite (SPS) Systems, Final Version, June 2007.
51. R.M. Dickinson, "Magnetron Directional Amplifier Space Solar Power Beamer Concept Design," 35th IECEC Conference Proceedings, Las Vegas, NV, USA, July 24, 2000, pp. 1469-1479.
52. A. Beunas, G. Faillon, S. Choroba, and A. Gamp, "A High Efficiency Long Pulse Multi Beam Klystron for the TESLA Linear Collider," TESLA Report 2001-01.
53. Toshiba Electron Tubes & Devices Co., LTD., *Electron Tube Product Literature* from web site: <http://www.toshiba-tetd.co.jp/eng/product/microwave/03klys.htm>, September 2008.
54. E Beam Inc., *Klystron and Travelling Wave Tube Product Description* from web site: <http://www.ebeaminc.com/projects.htm>, September 2008.
55. H.D. Cohen, "Spacecraft Technology for Broadcasting Satellites-An Update," *IEEE Journal on Selected Areas in Communications* **SAC-3**(1), January 1985.
56. N. Shinohara and H. Matsumoto, "Microwave Power Transmission System with Phase and Amplitude Controlled Magnetrons," Proceedings of 2nd International Conference on Recent Advances in Space Technologies (RAST 2005), Istanbul, Turkey, Digital Object Identifier 10.1109/RAST.2005.1512529, pp. 28-33.
57. N. Shinohara and H. Matsumoto, "Design of Space Solar Power System (SSPS) with Phase and Amplitude Controlled Magnetron," Proceedings of the 2004 Asia-Pacific Radio Science Conference (APRASC 2004), Chintao, China, Digital Object Identifier 10.1109/APRASC.2004.1422587, pp. 624-626.
58. Data Sheet for VMX 1090 Magnetron, Communications & Power Industries, Beverly, Massachusetts.
59. N. Shinohara, H. Matsumoto, and K. Hashimoto, "Solar Power Station/Satellite (SPS) with Phase Controlled Magnetrons," *IEICE Trans. Electron.* **E86-C**(8), August 2003.
60. T. Mitani, N. Shinohara, K. Hashimoto, and H. Matsumoto, "Study on High-Efficiency and Low-Noise Wireless Power Transmission for Solar Power Station/Satellite," Presentation at the Sustainable Energy and the Environment Conference (SEE2006), November 21, 2006, Thailand.
61. P. Goudket, R. Bate, D.M. Dykes, R.L. Geng, S. Belomestnykh, H. Padamsee, and R.G. Carter, "Multipactor Studies in Rectangular Waveguides," 11th Workshop on RF-Superconductivity, SRF 2003, September 2003, paper identifier ThP25.
62. E. Chojnacki, "Simulations of a Multipactor-Inhibited Waveguide Geometry," *Physical Review Special Topics - Accelerators and Beams* **3**, 032001, 2000.

63. V.E. Semenov, E.I. Rakova, D. Anderson, M. Lisak, and J. Puech, "Multipactor in Rectangular Waveguides," *Physics of Plasmas* **14**, 033501, 2007.
64. B. Foster, I. Gonin, T. Khabibouline, A. Makarov, N. Solyak, I. Terechkine, and D. Wildman, "High Power Phase Shifter," Proceedings of 2005 Particle Accelerator Conference, Knoxville, Tennessee, pp. 3123-3125.
65. R. Madrak, D. Sun, D. Wildman, E. Cherbak, and D. Horan, "New Materials and Designs for High-Power, Fast Phase Shifters," Proceedings of LINAC 2006, Knoxville, Tennessee, pp. 829-833.
66. nGimat Company, product brochure: "RF Wireless Phase Shifters," from web site: http://www.ngimat.com/pdfs/RF_Wireless_Phase_Shifters.pdf, September 2008.
67. M. Mori, K. Hideshi, and Y. Saito, "Summary of Studies on Space Solar Power Systems of Japan Aerospace Exploration Agency (JAXA)," *Acta Astronautica* **59**, 132-138, 2006.
68. D.J. Phillips, R.L. Laycock, S.T. Cole, W.W. Walker, S.D. Moultrie, J.C. Reinhardt, R.L. Fork, and J.T. Howell, "Technology Demonstrations and Flight Experiments Validating an Optical Energy Infrastructure for Earth—Moon Space," *Acta Astronautica* **62**, 185–191, 2008.
69. DARPA Website, "Super High Efficiency Diode Sources (SHEDS)," <http://www.darpa.mil/mto/programs/sheds/>, September 2008.
70. T. Saiki, S. Motokoshi, K. Imasaki, K. Fujioka, H. Fujita, M. Nakatsuka, Y. Izawa, and C. Yamanaka, "Nd/Cr:YAG Ceramic Active-Mirror Laser Pumped by Quasi-solar Light Sources," Institute of Laser Engineering Annual Progress Report, Osaka University, 2006, p. 189-190, <http://www.ile.osaka-u.ac.jp/zone1/public/publication/apr/2006/contents.html>.
71. T. Yabe, T. Ohkubo, S. Uchida, K. Yoshida, M. Nakatsuka, T. Funatsu, A. Mabut, A. Oyama, K. Nakagawa, T. Oishi, K. Daito, B. Behgol, Y. Nakayama, M. Yoshida, S. Motokoshi, Y. Sato, and C. Baasandash, "High-efficiency and Economical Solar-energy-pumped Laser with Fresnel Lens and Chromium Codoped Laser Medium," *Appl. Phys. Lett.* **90**(26), Art. No. 261120, June 25, 2007, <http://adsabs.harvard.edu/abs/2007ApPhL.90z1120Y>.
72. R.L. Fork, R.L. Rustin, L. Laycock, W.W. Walker, S.T. Cole, S.D. Moultrie, D.J. Phillips, and J.C. Reinhardt, "Surface High-Energy Laser," *Proc. IEEE* **93**, 10, 2005.
73. R.E. Beverly III, "Satellite Power Systems (SPS) Laser Studies, Volume I: Laser Environmental Impact Study," NASA Contractor Report 3346, 1980.
74. E.J. Nalos, W.W. Lund, O. Denman, and S.M. Rathjen, "Microwave Power Beaming for Long Range Energy Transfer," *European Microwave Conference, 1978*. 8th Vol., pp. 573-578, Oct. 1978.
75. M. Niroojazi and M.N. Azarmanesh, "Practical Design of Single Feed Truncated Corner Microstrip Antenna," Proceedings of the Second Annual Conference on Communication Networks and Services Research, Volume 00, pp. 25-29.
76. P.C. Sharma and K.C. Gupta, "Analysis and Optimized Design of Single Feed Circularly Polarized Microstrip Antennas," *IEEE Transactions on Antennas and Propagation* **AP-31**(6), 949-955, November 1983.
77. P.C. Sharma and K.C. Gupta, "Optimized Design of Single Feed Circularly Polarized Microstrip Patch Antennas," Antennas and Propagation Society International Symposium, Volume 20, May 1982, pp. 156-159.
78. N. Shinohara and H. Matsumoto, "Experimental Study of Large Rectenna Array for Microwave Energy Transmission," *IEEE Transactions on Microwave Theory and Techniques* **46**(3), 261-268, March 1998.

79. Y.J. Ren and K. Chang, "New 5.8-GHz Circularly Polarized Retrodirective Rectenna Arrays for Wireless Power Transmission," *IEEE Transactions on Microwave Theory and Techniques* **54**(7), 2970-2976, 2006.
80. Y.J. Ren and K. Chang, "5.8-GHz Circularly Polarized Dual-Diode Rectenna and Rectenna Array for Microwave Power Transmission," *IEEE Transactions on Microwave Theory and Techniques* **54**(4), 1495-1502, April 2006.
81. J.L. Volakis, *Antenna Engineering Handbook: Fourth Edition* (McGraw Hill, New York, 2007), pp. 32-26 – 32-30.
82. L.H. Hsieh, B.H. Strassner, S.J. Kokel, C.T. Rodenbeck, M.Y. Li, K. Chang, F.E. Little, G.D. Amdt, and P.H. Nga, "Development of a Retrodirective Wireless Microwave Power Transmission System," IEEE Antennas and Propagation Society International Symposium, 2003, Vol. 2, June 22-27, 2003, pp. 393- 396.
83. S.S. Bharj, R. Camisa, S. Grober, F. Wozniak, E. Pendleton, "High Efficiency C-Band 1000 Element Rectenna Array for Microwave Powered Applications," Microwave Symposium Digest, 1992, IEEE MTT-S International, Vol.1, June 1-5, 1992, Albuquerque, NM, pp. 301-303.
84. B. Strassner and K. Chang, "A Circularly Polarized Rectifying Antenna Array for Wireless Microwave Power Transmission with over 78% Efficiency," 2002 IEEE MTT-S Digest, pp. 1535-1538.
85. S. Hollander, K. Swider-Lyons, M. Osborn, and R. Rosenfeld, "Water-Based Propulsion for Space Applications," AIAA 2005-4122, 41st AIAA/ASME/SAE/ASEE Joint Propulsion Conference & Exhibit. 10 – 13 July 2005, Tucson, Arizona.
86. J. D. Boyes and N. Clark, "Flywheel Energy Storage and Super Conducting Magnetic Energy Storage Systems," presentation from IEEE PES 2000, Seattle, WA, July 19, 2000. (<http://www.electricitystorage.org/pubs/2000/summer2000/SMES-FES.pdf>).
87. A.J. Cavallo, "Energy Storage Technologies for Utility Scale Intermittent Renewable Energy Systems," *Journal of Solar Energy Engineering* **123**, 387-389, November 2001.
88. Energy Storage Association website http://electricitystorage.org/tech/technologies_comparisons.htm
89. R.B. Schainker, "Emerging Technologies to Increase the Penetration and Availability of Renewables: Energy Storage – Executive Summary," presentation from CEC Integrated Energy Policy Workshop, July 2008. (http://www.energy.ca.gov/2008_energypolicy/documents/2008-07-31_workshop/presentations/Energy_Storage-Schainker.pdf)
90. J.P. Thomas, M.A. Qidwai, and J. Kellogg, "Energy Scavenging for Small-Scale Unmanned Systems," *J.Power Sources* **159**(2), 1494-1509, 2006.
91. Y.J. Ren and K. Chang, "Bow-tie Retrodirective Rectenna," *Electron. Lett.* **42**(4), 191-192, 2006.
92. R.Y. Miyamoto and T. Itoh, "Retrodirective Arrays for Wireless Communications," *Microwave Magazine, IEEE* **3**(1), 71-79, 2002.
93. T. Uno and S. Adachi, "Optimization of Aperture Illumination for Radio Wave Power Transmission," *IEEE Trans. Antennas and Propag.* **AP-32**(6), 628-632, 1984.
94. A. Hoorfar, S. Lakhani, and V. Jamnejad, "Application of Lévy Mutation Operator in Evolutionary Programming Optimization of Antennas," International Conference on Electromagnetics in Advanced Applications, 2007, ICEAA 2007, September 17-21, 2007, pp. 191-194. ISBN: 978-1-4244-0767-5.

95. W.C. Brown and E.E. Eves, "Beamed Microwave Power Transmission and its Application to Space," *IEEE Transactions on Microwave Theory and Techniques* **40**(6), 1239-1250, June 1992.
96. A.W. Love, "Basics of SPS Power Transmission from Space," *IEEE Antennas and Propagation Society Newsletter*, December 1980, pp. 5-8.
97. J.O. McSpadden and J.C. Mankins, "Space Solar Power Programs and Microwave Wireless Power Transmission Technology," *IEEE Microwave Magazine*, 46-57, December 2002.
98. S. Takeshita, "Power Transfer Efficiency Between Focused Circular Antennas with Gaussian Illumination in Fresnel Region," *IEEE Transactions on Antennas and Propagation* **AP-16**(3), May 1968.
99. N. Davinic, A. Arkus, S. Chappie, and J. Greenberg, "Cost-Benefit Analysis of On-Orbit Satellite Servicing," *Journal of Reducing Space Mission Cost* 1, 27-52, 1998.
100. http://www.nasa.gov/mission_pages/constellation/ares/aresV/index.html
101. Atlas Launch System Mission Planner's Guide, Rev 10a January 2007, Lockheed Martin Commercial Launch Services.
102. M.F. Osborn, P.F. Cary, and R.T. Beal, "Pioneering Propulsion Systems, Engineering Challenges and Solutions," Proceedings: Session 113-LP-19, Propulsion Systems Implemented in Early Small Spacecraft, 39th Joint Propulsion Conference, Huntsville, AL, July 2003.
103. M. Osborn, C. Clauss, B. Gorin, and C. Netwall, "Micro-satellite Technology Experiment (MiTex) Upper Stage Propulsion System Development," AIAA-2007-5434. 43rd AIAA/ASME/SAE/ASEE Joint Propulsion Conference, Cincinnati, Ohio, July 8-11, 2007.
104. E.A. Bering III, M. Brukardt, J.P. Squire, T.W. Glover, V. Jacobson, and G. McCaskill, "Recent Improvements in Ionization Costs and Ion Cyclotron Heating Efficiency in the VASIMR Engine," 44th AIAA Aerospace Sciences Meeting and Exhibit AIAA-2006-766 Reno, Nevada, 9-12 January 2006.
105. Y.K. Bae, "Photonic Laser Thruster (PLT) for Reducing the Mass of Structure and Propellant of Space Based Solar Power (SBSP) Systems," 2008 AFRL Solar Power Workshop.
106. M.F. Osborn and C. Netwall, "High Performance Xenon Flow System (XFS) Optimized for Low Mass, Volume, and Cost," AIAA-2007-TBD. AIAA/ASME/SAE/ASEE Joint Propulsion Conference, July 2009.
107. J. Ku, "Overview of Capillary Pumped Loop Technology," 1993 ASME National Heat Transfer Conference, Atlanta, Georgia, 1993.
108. G. Birur, J. Rodriguez, and M. Nikitkin, "Loop Heat Pipe Applications for Thermal Control of Martian Landers/Rovers," 10th Annual Spacecraft Thermal Control Technology Workshop, The Aerospace Corporation, El Segundo, California, February 24-26, 1999.
109. N. Dunbar, "ALTID Laser Heat Thermal Control Design and Development of a Two-Phase Heat Transport System for Practical Applications," SAE Paper No. 961561, 1996.
110. S. Van Oost, M. Dubois, G. Bedaert, B. Moschetti, and M. Amidieu, "High Performance Capillary Loop, Operation Mapping and Applications on STENTOR," SAE Paper No. 961565, 1996.
111. D. Douglas, J. Ku, and T. Kaya, "Testing of the Geoscience Laser Altimeter System (GLAS) Prototype Loop Heat Pipe," AIAA Paper No. 99-0473, 1999.

112. T. Hoang, M. Brown, R. Baldauff, and S. Cummings, "Development of a Two-Phase Capillary Pumped Heat Transport for Spacecraft Central Thermal Bus," Proceedings of 2003 STAIF, Albuquerque, NM.
113. K. Cheung, T. Hoang, J. Ku, and T. Kaya, "Thermal Performance and Operational Characteristics of Loop Heat Pipe (NRL LHP)," SAE Paper No. 981813, 1998.
114. T. Kaya, J. Ku, T. Hoang, and K. Cheung, "Investigation of Low power Start-up Characteristics of a Loop Heat Pipe," Space Technology and Applications International Forum –1999, CP458, pp. 799-804.
115. K. Cheung, "Flight Qualification of Copper Water Heat Pipes at Naval Research Laboratory," 38th AIAA Thermalphysics Conference, 2005.
116. T. Hoang, R. Baldauff, and K. Cheung, "Hybrid Two-Phase Mechanical/ Capillary Pumped Loop for High-Capacity Heat Transport," 2007 International Conference on Environmental Sciences, July 2007.
117. T. Hoang, R. Baldauff, and K. Cheung, "Evaluation of a Magnetically-Driven Bearingless Pump for Spacecraft Thermal Management," International Energy Conversion Engineering Conference, June 2007.
118. T. Hoang, S. Dmitriy, R. Baldauff, and K. Cheung, "Issues with LHP Testing in 1-g Environment," AIAA Thermophysics Conference, Miami, June 2007.
119. T. Hoang, S. Dmitriy, R. Baldauff, K. Cheung, and D. Zakar, "Gravitational Effects on Loop Heat Pipe Performance," 14th International Heat Pipe Conference, Brazil, April 2007.
120. R. Baldauff, K. Cheung, and T. Hoang, "Start-Up Behavior of an Ammonia Loop Heat Pipe," 14th International Heat Pipe Conference, Brazil, April 2007.
121. M. Mikulas, "Structural Efficiency of Long, Lightly Loaded Truss and Isogrid Columns for Space Applications," NASA TM-78687, Langley Research Center, 1978.
122. T. Murphy, "Some Performance Trends in Hierarchical Truss Structures," AIAA-2003-1903.
123. R.T. Jones, D.G. Bellemore, T.A. Berkoff, J.S. Sirkis, M.A. Davis, M.A. Putnam, E.J. Friebele, and A.D. Kersey, "Determination of Cantilever Plate Shapes Using Wavelength Division Multi-plexed Fiber Bragg Grating Sensors and a Least Squares Strain Fitting Algorithm," in *Smart Materials and Structures*, Vol. 7, 1998, doi: [10.1088/0964-1726/7/2/005](https://doi.org/10.1088/0964-1726/7/2/005), pp. 178-188.
124. E.J. Friebele, C.G. Askins, M.A. Putnam, A.A. Fosha Jr., J. Florio Jr., R.P. Donti, and R.G. Blosser, "Distributed Strain Sensing with Fibre Bragg Grating Arrays Embedded in CRTM Composites," *Electronics Letters* **30**(21), 1783-1784, Oct. 1994.
125. G. Creamer, G.C. Kirby, R.E. Weber, A.B. Bosse, and S. Fisher, "An Integrated GPS/Gyro/Smart Structures Architecture for Attitude Determination and Baseline Metrology," *J. Instit. Navigation* **45**(4), 307-321, Winter 1998-1999.
126. F. Tasker, B. Dunn, and S. Fisher, "Online Structural Damage Detection using Subspace Estimation," IEEE Aerospace Conference, 1999 Proceedings, Snowmass, Aspen, March 1999, Vol. 2, pp. 173-179.
127. S. Dubowsky and P. Boning, "The Coordinated Control of Space Robot Teams for the On-Orbit Construction of Large Flexible Space Structures," 2007 IEEE International Conference Robotics and Automation, April 2007.
128. F. Tasker and G. Henshaw, "Managing Contact Dynamics for Orbital Robotic Servicing Missions," 2008 AIAA Space Conference, San Diego.

129. "Design Requirements for Orbit Maintenance of SPS Elements," DOE ER-0087, Nov 1980.
130. H. Ueno, "Simulation, Analysis and Experiments of On-orbit Assembly Behavior on Flexible Structure by Cooperative Robots," 24th International Symposium on Space Technology and Science, Miyazaki, Japan, May 2004.
131. J. Black, "Power Beaming Space Experiment," Air Force Institute of Technology, presented July 31, 2008, at NASA GRC.

Appendix A

SELECTED STUDY ACTIVITIES

The study group has heard from distinguished figures in the field of SBSP: John Mankins, widely recognized as one of the world's leading experts on SBSP and a former manager of NASA's Advanced Concepts Studies Office, spoke with us. He is also a creator of the TRL level grading system. Lt. Col. Peter Garretson, one of the coordinators and authors of the NSSO report, also briefed the group.

Several representatives from the NRL study group supported the AFRL-sponsored Military Power Requirements Symposium in early July 2008. Members from the services were introduced to the SBSP concept and asked how it might provide useful and unique capabilities to meet their needs. Requirements and concepts were identified and considered in the formulation of this report.

A summary of preliminary findings from this report was presented at the AFRL-sponsored State of Space Based Solar Power workshop in October 2008.

Appendix B
CONTRIBUTORS

NRL SBSP Study Group:

Johnson, Neil (Chair)	Henshaw, Glen	Messenger, Scott
Akins, Keith	Huber, David	Mook, Mike
Armstrong, Jim	Huynh, Steve	Nurnberger, Mike
Bartolo, Bob	Jaffe, Paul	Osborn, Mike
Boncyk, Wayne	Jenkins, Phillip	Pasour, John
Brown, Mike	Kirby, George	Skalitzky, Robert
Cheung, Kwok	Kub, Fritz	Smith, Nathan
Dahlburg, Jill	Levush, Baruch	Tasker, Frederick
Dorsey, Mark	Long, Matthew	Walters, Rob
Gubser, Don	Lovellette, Michael	Williams, Keith

Study Observers:

Baldauff, Robert	Johnson, Mark	Pehrsson, Pehr
Danly, Bruce	LaCava, Susie	Pirozzoli, James
Driggers, Ron	Lim, Tae	Schaub, John
Foch, Rick	McCord, Mike	Webb, Denis
Jackson, Eric	Parent, Mark	Wilhelm, Pete

Appendix C

NOTES ON MICROWAVE TRANSMISSION EFFICIENCIES

C1. INTRODUCTION

The ability to beam Solar Power from space to Earth in the form of microwave energy is an interesting challenge to many disciplines of engineering and physics. A feasibility study is required to determine whether the technology exists to perform power beaming in a cost effective, efficient, and safe manner. From an electromagnetic standpoint, this task presents many challenges that must be addressed ranging from, but not limited to, atmospheric losses, array size (both in space and on the ground), beam accuracy, and power density of the transmitted beam on the Earth's surface. The link budget for the wireless power transmission from Geostationary Orbit (GO) to a rectenna located on Earth can be calculated using the Friis transmission equation if farfield conditions are assumed. However, if the aperture sizes and beam shape are selected such that the transmitting and receiving apertures satisfy the Fresnel Near Field conditions, high transmission efficiency can be obtained.

C2. WIRELESS POWER TRANSMISSION USING FRIIS TRANSMISSION EQUATION

The power received at the ground from a transmitting array in geostationary orbit can be calculated from the Friis transmission equation [C1]. An illustration of this configuration is shown in Fig. C1, where the distance R is taken to be the distance to a satellite in geostationary orbit. The power collected by a receiving array having effective area of A_r from the transmitting solid angle Ω is given by the source radiance L and the geometric throughput $A_r\Omega$ as seen in Eq. (C1).

$$P_r = LA_r\Omega \quad (C1)$$

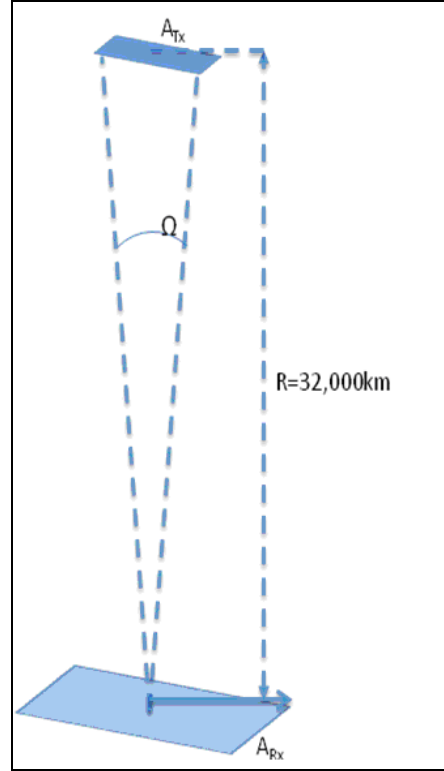

Fig. C1 – Illustration of transmission geometry

Before proceeding with the calculation, a few terms must be defined.

- $A_{r,t}$: *effective area* of the receiving or transmitting antenna
- $\epsilon_{r,t}$: *efficiency* of the receiving or transmitting antenna
- Ω_t : *solid angle* subtended by the transmitting antenna with effective area A_t : $\left(\Omega_t = A_t / R^2\right)$
- D : The *directivity* of an antenna is the ratio of its solid angle to the solid angle of an isotropic radiator: $\left(D = 4\pi / \Omega\right)$
- Throughput: the product of the aperture area and the beam solid angle: $(A\Omega = \lambda^2)$

In the far field, the solid angle of a transmitted antenna can be defined in terms of a cross-sectional beam area (A_b) as seen in Eq. (C2). This definition results in the directivity definition of Eq. (C3).

$$\Omega_t = \frac{A_b}{R^2} \quad (C2)$$

$$D_t = \frac{4\pi R^2}{A_b} \quad (C3)$$

Diffraction causes the beam of electromagnetic energy to spread into an angle defined in Eq. (C4). This results in the beam area on the ground as defined in Eq. (C5), where d is the dimension of a side (assuming a square aperture). If the receiving aperture is equal in area to the beam area, 100% transmission efficiency should be expected if the transmission is otherwise lossless (i.e., 100% antenna efficiency, no atmospheric losses, 100% polarization efficiency, etc.).

$$\theta \cong \frac{\lambda}{d} \quad (C4)$$

$$A_b \cong \frac{R^2 \lambda^2}{A_t} \quad (C5)$$

As the wavelength increases (or frequency decreases), either the aperture area must increase proportionally or the beam will spread into a proportionally larger solid angle. Therefore, larger apertures are required for efficient transmission at lower frequencies.

The product of the radiance and the receiver throughput can be used to find the received power. The radiance is defined in Eq. (C6), and the received power is shown in Eq. (C7). The definition for the received power (P_r) shown in Eq. (C7) is a commonly used form of the Friis transmission formula [C2].

$$L_t = \frac{P_t}{A_t \Omega_b} = \frac{P_t}{\lambda^2} \quad (C6)$$

$$P_r = L A_r \Omega_t = \frac{P_t A_r A_t}{\lambda^2 R^2} \quad (C7)$$

A useful quantity is the transmission efficiency, which can be defined as the ratio of the received power to the transmitted power. This equation can be made to incorporate the antenna efficiencies by replacing the effective areas with the product of the physical aperture size and the antenna efficiency. The expression in Eq. (C8) can be used to evaluate the transmission efficiency if all other loss mechanisms are neglected. Therefore, this expression is a best case scenario that cannot be fully realized. The maximum value of this efficiency is 1 (i.e., $P_r = P_t$). This optimum efficiency is realized when the efficiencies of each antenna is 100% and the effective area of the receive antenna equals the cross-sectional area of the solid angle subtended by the transmitting array at a distance R . If the area of the receive array grows larger than this area, the receive antenna efficiency will decrease due to the extremities of the array not being illuminated.

$$\varepsilon_{trans} = \frac{P_r}{P_t} = \varepsilon_r \varepsilon_t \frac{A_{pr} A_{pt}}{\lambda^2 R^2} = \varepsilon_r \varepsilon_t \left(\frac{\lambda}{4\pi R} \right)^2 D_t D_R \quad (C8)$$

Figure C2 shows the transmission efficiency as a function of receive aperture physical area for a frequency of 5 GHz. This calculation assumes a transmitting array with physical area of 10^4 m^2 and 100% efficiency. The curves show that an extremely large aperture is required to achieve transmission efficiencies of greater than 25% to 30%. Additionally, the maximum transmission efficiency in each case

is equal to the efficiency of the receiving antenna array, and it will be even lower if other sources of loss and inefficiency are included.

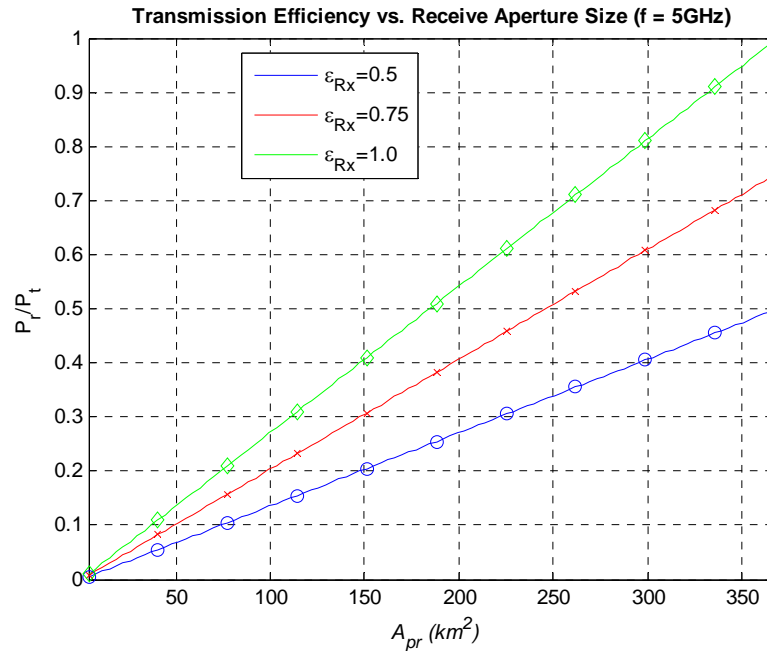

Fig. C2 – Transmission efficiency vs receive array (5 GHz)

If the frequency is increased to 35 GHz, the directivity of the transmitting array becomes much greater, and the illuminated area on the ground decreases. Subsequently, smaller apertures are required to achieve high efficiencies as seen in Fig. C3. However, the efficiencies on the receive antenna are difficult to maintain at high frequencies due to the tighter physical tolerances resulting from a short wavelength. This illustrates one of the many tradeoffs that will be present in this transmission problem.

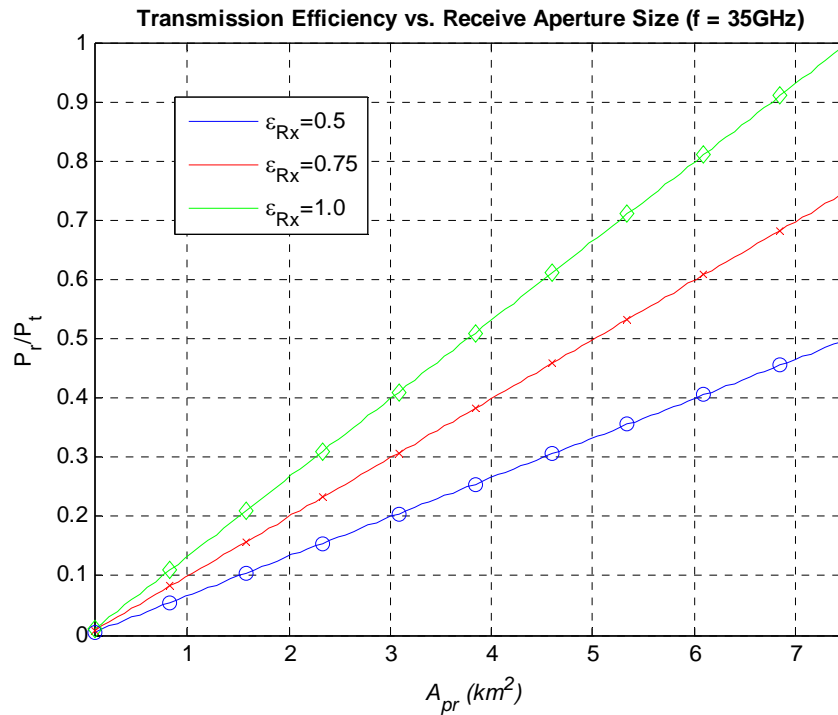

Fig. C3 –Transmission efficiency vs receive area (35 GHz)

If the operational frequency is left at 35 GHz, but the transmitting antenna's efficiency drops to 75%, the total transmission efficiency is reduced to the values shown in Fig. C4. This figure illustrates one of the key limitations in transmitting a plane wave from geostationary orbit to Earth. The beam spreading due to diffraction creates the necessity for extremely large arrays in order to establish a reasonable transmission efficiency between the transmitter and the receiver.

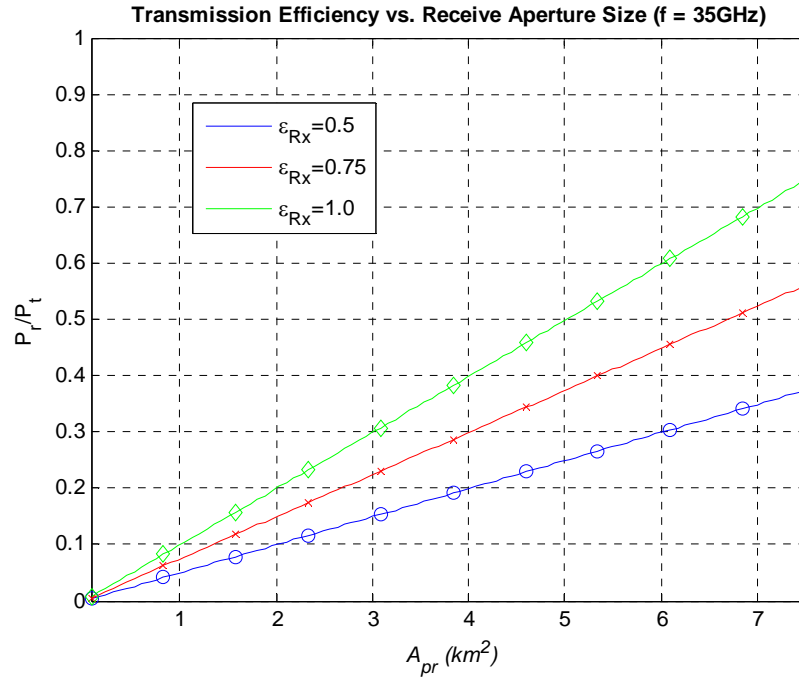

Fig. C4 – Transmission efficiency vs receive area (35 GHz, $\epsilon_t = 75\%$)

C3. WIRELESS POWER TRANSMISSION IN THE NEAR FIELD

The transfer of power between a source in geostationary orbit and a receiver on Earth requires the efficient transfer of microwave power over a distance of $\sim 36,000$ km. Using far-field conditions (i.e., transmit antenna focused at infinity), the transmission efficiency can be calculated using Eq. (C9). This result indicates that the maximum efficiency occurs when the transmitted beam completely illuminates the receive antenna aperture [C3].

$$\eta = \frac{A_t A_r}{d^2 \lambda^2} \quad (\text{C9})$$

More efficient power transmission can be realized if the antennas are operated in the Fresnel region. This allows the transmit antenna to be focused on the receive aperture instead of being focused at infinity. This is accomplished by introducing a quadratic phase profile across the array, resulting in the distribution shown in Eq. (C10). The amplitude distribution in Eq. (C10) is left as $f(r)$. There have been studies on optimizing the amplitude taper to maximize the power captured at the receive antenna by minimizing the sidelobes of the transmit antenna [C4, C5]. Many of the studies on the amplitude tapers have shown that the optimized amplitude tapers are essentially Gaussian [C6, C7].

$$E_t(r) = f(r) e^{j \frac{k}{2d} r^2}, 0 < r \leq r_t \quad (\text{C10})$$

The Gaussian amplitude taper is defined by the σ value of the distribution. This value determines the illumination at the edge of the array (assuming a circular aperture). Previous work has shown that a -10

dB Gaussian taper can provide efficient energy transmission between geostationary orbit and Earth [C8]. After the σ value is selected, the transmission efficiency can be calculated from Eq. (C11), where c is the Fresnel number defined in Eq. (C12) [C9].

$$\eta = \frac{16\sigma_t\sigma_r c^2}{(1-e^{-2\sigma_t})(1-e^{-2\sigma_r})(4\sigma_t\sigma_r+c^2)^2} \left[1 - e^{-(\sigma_r+\sigma_t)} \left\{ \sum_{i=1}^2 \sum_{q=0}^{\infty} \left(\frac{2\sigma_i}{c} \right)^q J_q(c) - J_0(c) \right\} \right]^2 \quad (C11)$$

$$c = \frac{kr_r r_t}{d} \quad (C12)$$

As an example, consider the case of a circular aperture with a 500-m radius in geostationary orbit designed to operate at 2.45 GHz using a Gaussian taper with $\sigma = 1.5$. This frequency is commonly used because of its location in the ISM band, low-cost components, and low attenuation through the atmosphere [C3, C7]. The amplitude and phase taper in any radial cut through this array are seen in Fig. C5. This taper reflects the quadratic phase profile needed to focus the transmit antenna on the receive antenna. The Gaussian amplitude taper shows that the edges of the array are 13 dB down from the amplitude at the center of the array.

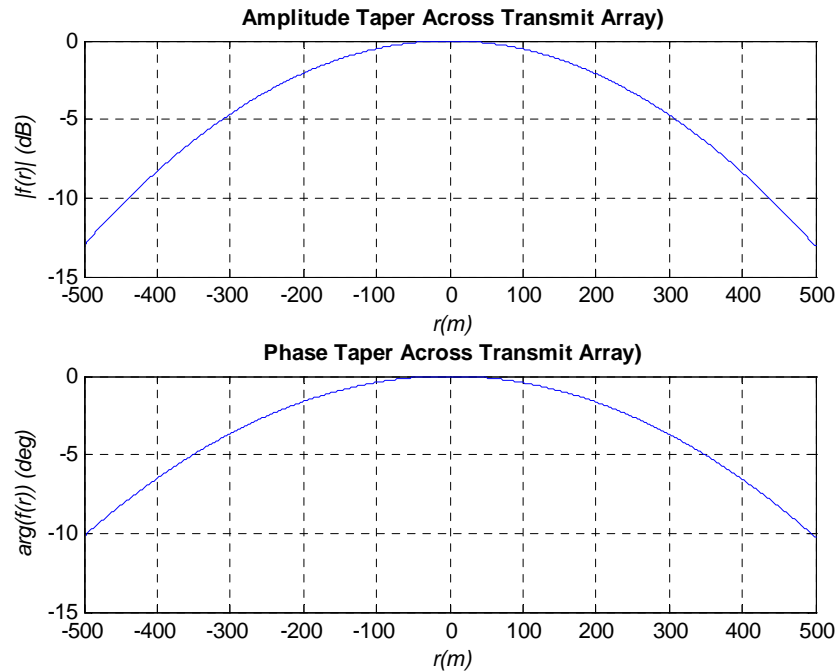

Fig. C5 – Sample amplitude and phase weighting

The transmission efficiency shown calculated in Eq. (C11) will be maximized for a particular Fresnel number that can be calculated from Eq. (C12). If the same amplitude taper is assumed on both arrays, the transmission efficiency as a function of the receive array radius is shown in Fig. C6. This plot shows a maximum transmission efficiency of 96.66% for a receive array having a radius of 5.6 km. This radius corresponds to a Fresnel number of 4.0, which matches the optimum value provided in Ref. C9. Smaller

apertures can be used at the expense of transmission efficiency. Table C1 provides some receive array radius values and the corresponding transmission efficiencies.

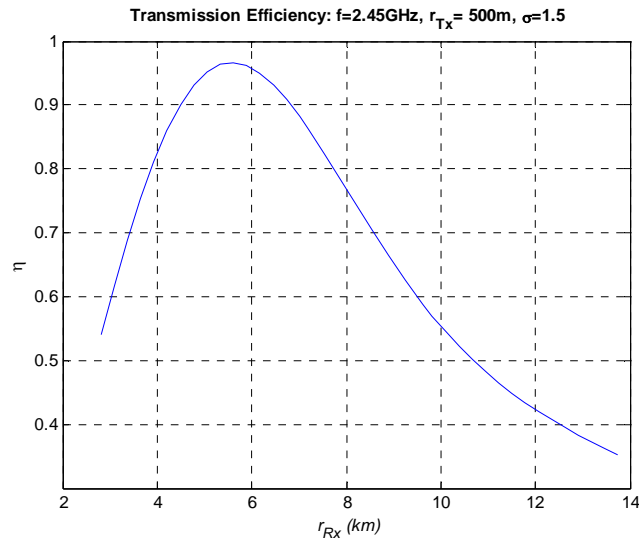

Fig. C6 – Transmission efficiency vs receive array radius

Table C1 – Transmission Efficiency vs Receive Array Radius

Receive Radius (r_r)	Transmission Efficiency (η)
5.6 km	96%
4.49 km	90%
3.88 km	80%
4.42 km	70%

These calculations have been performed using an amplitude taper of near -10 dB [C8] and a quadratic phase shift. The transmit array was not chosen as an optimum value. Instead, it was chosen to illustrate that high power transmission efficiency can be realized if the correct Fresnel number is chosen.

It should be noted that generating the appropriate phase and amplitude taper on both the receiving and transmitting aperture provides technological difficulties that will need to be addressed. The key to obtaining a high efficiency for a large rectenna array appears to be driving all elements within the array near their optimum power density. In the case of a uniformly illuminated array [C10], the rectenna element can be optimized for the anticipated power density. However, in the case of a tapered amplitude distribution (i.e., Gaussian), each element within the rectenna will be subjected to a different power density. This will add another degree of complexity to the design of such a large rectenna structure. In many transmitting array configurations requiring amplitude tapers (i.e., sidelobe control), attenuators are present at each element. The attenuation is increased to essentially “throw away” energy at elements requiring reduced amplitude. In SBSP, throwing away energy at elements across such a large array would result in a reduction of the overall system efficiency. A different approach needs to be realized to allow

for efficiency generation of the amplitude taper on the transmitting antenna to make this approach feasible.

C4. ATMOSPHERIC CONSIDERATIONS

Much of the preliminary research in this area comes from Simon R. Saunder's text on Wireless Communication Systems [C11]. This text uses a distance of 36,000 km for the radius of the orbit for geostationary satellites. If plane wave transmission is used, this distance leads to the dominant loss component for electromagnetic propagation from geostationary orbit to the surface of Earth: free-space loss. The spherical spreading of power due to the spherical wave will decrease the power density of the emitted wave by a factor proportional to r^2 . The definitions for this path loss are shown in Eqs. (C13) and (C14). A path loss of greater than 193 dB is calculated from Eq. (C2) for a separation of 36,000 km at a frequency of 3 GHz. This path loss will make it difficult to achieve a high efficiency in the power beaming without a huge receive aperture and extremely narrow transmit beam. As mentioned previously, this presents the fundamental limitation in efficiently transmitting microwave energy from geostationary orbit to Earth.

$$L_f = \left(\frac{4\pi r}{\lambda} \right)^2 = \left(\frac{4\pi r f}{c} \right)^2 \quad (C13)$$

$$L_{f(dB)} = 32.4 + 20 \log_{10} R_{km} + 20 \log_{10} f_{MHz} \cdot \quad (C14)$$

In addition to the path loss, other tropospheric and ionospheric effects will add additional loss factors. Some of the dominant atmospheric effects are discussed below.

C4.1 Tropospheric Effects

1. The loss through the troposphere consists of *absorption* and *scattering*. The *absorption* stems from the conversion of RF energy to thermal energy within an attenuating particle (i.e., rain). *Scattering* results from the redirection of RF energy into various directions due to the interaction with particles. The primary *scattering* particles are hydrometeors (e.g., rain, clouds, and fog). *Scattering* can become significant at frequencies contained in X-Band and above. *Attenuation* rises with frequency, but not rapidly.
2. Tropospheric *refraction* results from the variations in refractive index. This index gradient must be accounted for when determining proper pointing angles for transmission.
3. Tropospheric *scintillation* results from turbulence blending the horizontal layers of the troposphere generating rapid variations in the index of refraction.
4. *Depolarization* can result from transmission through the troposphere. Rain is a major source of *depolarization* in the troposphere.

C4.2 Ionospheric Effects

1. *Faraday rotation* can rotate the polarization vector for linearly polarized waves. This will lead to decreased polarization efficiency, and subsequently will increase the path loss. This effect can be minimized by using circular polarization.
2. *Dispersion* will result from the frequency dependent group delay. This effect will smear a wide bandwidth transmit pulse.
3. *Scintillation* occurs in the ionosphere as it does in the troposphere.

C5. CONCLUSIONS

Space-based solar power (SBSP) presents a challenge to microwave engineering due to the requirement of efficient microwave power transmission over extremely long distances. The use of far field conditions to transmit a plane wave from the transmitting antenna in space to a rectenna located on the surface of the Earth is not practical due to the fundamental limitations resulting from diffraction. To eliminate this problem, the use of the appropriate amplitude and phase tapers results in high transmission efficiency that results from creating a giant beam waveguide [C7]. However, using tapered beams for high transmission efficiency is not without drawback. Achieving amplitude and phase tapers across an extremely large transmitting aperture in space without sacrificing any of the transmitting energy is not a trivial obstacle. Additionally, building an extremely large rectenna array capable of operating with different power densities at each while, at the same time, maintaining high conversion efficiency is also a challenge that must be addressed. However, these are challenges that can be satisfied with advances in technology. Conversely, the diffraction limited far field transmission presents obstacles resulting from physical limitations that cannot be resolved with technological advances. Consequently, any space-based solar power system utilizing microwave power transmission would need to use the shaped beam approach to make efficient wireless power transmission feasible.

REFERENCES

- C1. J.A. Shaw, "Radiometry and the Friis Transmission Equation," http://www.coe.montana.edu/ee/rwolff/EE548/sring05%20papers/Friis_Radiometric_2005Feb9.pdf.
- C2. D.C. Hogg, "Fun with the Friis Free-Space Transmission Formula," *IEEE Antennas and Propagation Magazine*, Vol. 35, No. 4, August 1993, pp. 33-35.
- C3. V. Jamnejad and A. Silva, "Microwave Power Beaming Strategies for Fractionated Spacecraft Systems," *Aerospace Conference, 2008 IEEE*, March 1-8, 2008, pp. 1-14.
- C4. T. Uno and S. Adachi, "Optimization of Aperture Illumination for Radio Wave Power Transmission," *IEEE Transactions on Antennas and Propagation* **AP-32**(6), 628-632, June 1984.
- C5. A. Hoorfar, S. Lakhani, and V. Jamnejad, "Application of Levy Mutation Operator in Evolutionary Programming Optimization of Antennas," *International Conference on Electromagnetics in Advanced Applications, 2007, ICEAA 2007*, pp. 191-194.
- C6. W.C. Brown, E.E. Eves, "Beamed Microwave Power Transmission and its Application to Space," *IEEE Transactions on Microwave Theory and Techniques* **40**(6), 1239-1250, June 1992.
- C7. A.W. Love, "Basics of SPS Power Transmission from Space," *IEEE Antennas and Propagation Society Newsletter*, 5-8, December 1980.
- C8. J.O. McSpadden and J.C. Mankins, "Space Solar Power Programs and Microwave Wireless Power Transmission Technology," *IEEE Microwave Magazine*, 46-57, December 2002.
- C9. S. Takeshita, "Power Transfer Efficiency Between Focused Circular Antennas with Gaussian Illumination in Fresnel Region," *IEEE Transactions on Antennas and Propagation* **AP-16**(3), May 1968.
- C10. S.S. Bharj, R. Camisa, S. Grober, F. Wozniak, E. Pendleton, "High Efficiency C-Band 1000 Element Rectenna Array for Microwave Powered Applications," *Microwave Symposium Digest, 1992, IEEE MTT-S International*, Vol.1, June 1-5, 1992, Albuquerque, NM, pp. 301-303.
- C11. S.R. Saunders, *Antennas and Propagation for Wireless Communication Systems* (John Wiley & Sons, LTD, New York, 1999), chapter 7.

Appendix D

NRL SPACE HISTORY

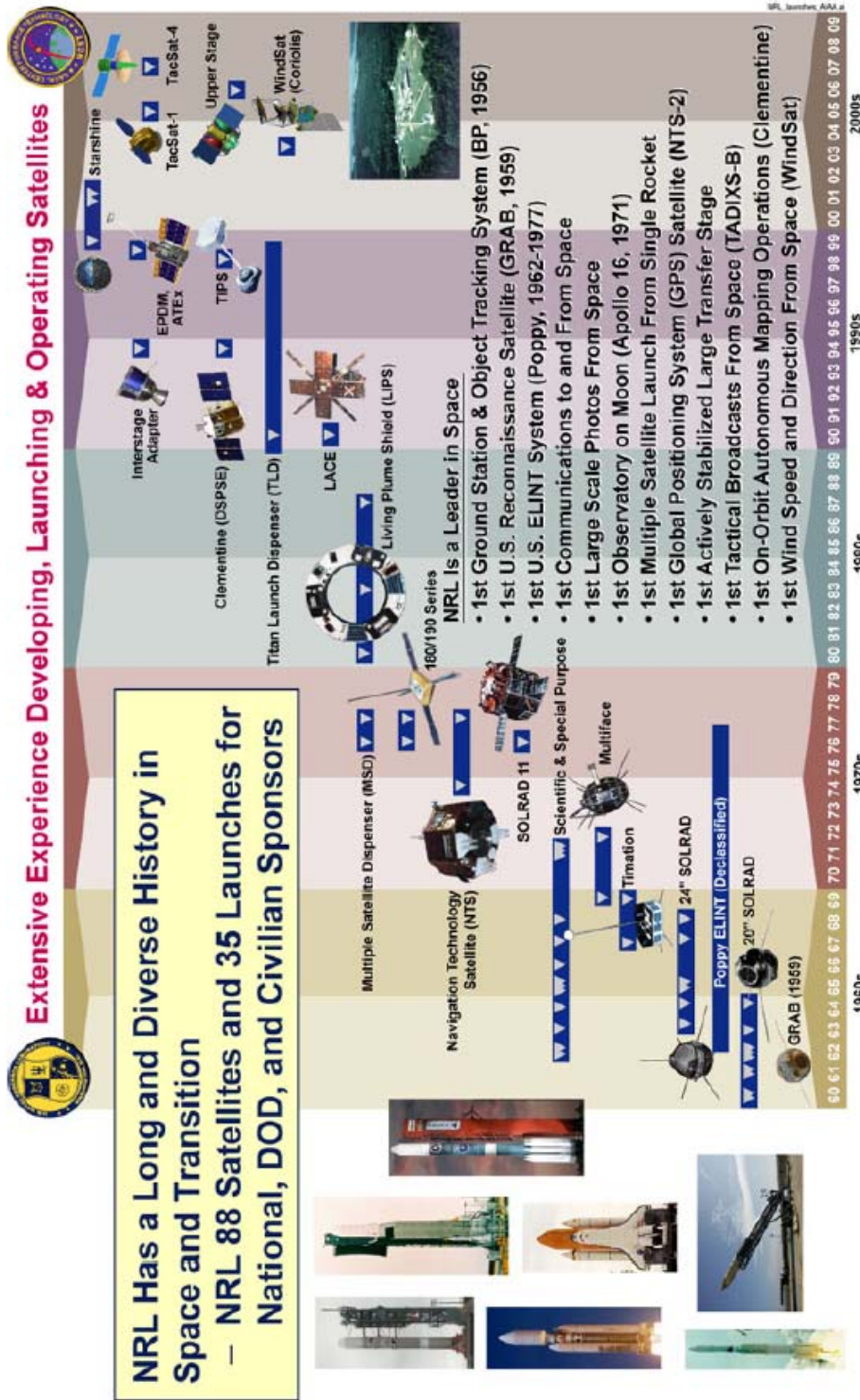

Fig. D1 – NRL History: Transformational Space Systems Development and Transition to Industry for Operational System Builds